

2022

Seltos

Owner's Manual

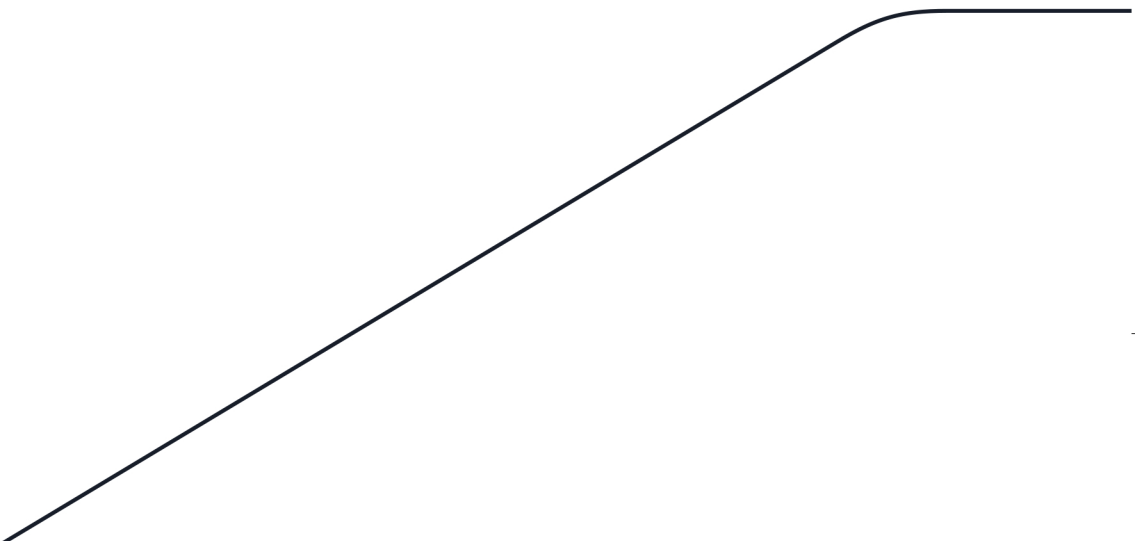

Movement that inspires



**WARNING - California
Proposition 65**

“Operating, servicing and maintaining a passenger vehicle or off-road vehicle can expose you to chemicals including engine exhaust, carbon monoxide, phthalates, and lead, which are known to the State of California to cause cancer and birth defects or other reproductive harm. To minimize exposure, avoid breathing exhaust, do not idle the engine except as necessary, service your vehicle in a well-ventilated area and wear gloves or wash your hands frequently when servicing your vehicle. For more information go to www.P65Warnings.ca.gov/passenger-vehicle.”



FOREWORD

Dear Customer,

Thank you for selecting your new Kia vehicle.

As a global car manufacturer focused on building high-quality vehicles with exceptional value, Kia is dedicated to providing you with a customer service experience that exceeds your expectations.

If technical assistance is needed on your vehicle, authorized Kia dealerships can provide you with factory-trained technicians, recommended special tools, and genuine Kia replacement parts.

This Owner's Manual will acquaint you with the operation of features and equipment that are either standard or optional on this vehicle, along with the maintenance needs of this vehicle. Therefore, you may find some descriptions and illustrations not applicable to your vehicle. You are advised to read this publication carefully and follow the instructions and recommendations. Please always keep this manual in the vehicle for your, and any subsequent owner's, reference.

All information contained in this Owner's Manual was accurate at the time of publication. However, as Kia continues to make improvements to its products, the company reserves the right to make changes to this manual or any of its vehicles at any time without notice and without incurring any obligations.

Please drive safely, and enjoy your Kia vehicle!

© 2021 Kia America, Inc.

All rights reserved. May not be reproduced or translated in whole or in part without the written consent of Kia America, Inc.

Printed in Korea

How to use this manual

We want to help you get the greatest possible driving pleasure from your vehicle. Your Owner's Manual can assist you in many ways.

We strongly recommend that you read the entire manual. In order to minimize the chance of death or injury, you must read the WARNING and CAUTION sections in the manual.

Illustrations complement the words in this manual to best explain how to enjoy your vehicle. By reading your manual, you learn about features, important safety information, and driving tips under various road conditions.

The general layout of the manual is provided in the Table of Contents. Use the index when looking for a specific area or subject. The index has an alphabetical listing of all information in your manual.

Chapters: This manual has eight chapters plus an index. Each chapter begins with a brief list of contents so you can tell at a glance if that chapter has the information you want.

You will find various WARNINGS, CAUTIONS, and NOTICES in this manual. These were prepared to enhance your personal safety. You should carefully read and follow ALL procedures and recommendations provided in these WARNINGS, CAUTIONS and NOTICES.

WARNING

A WARNING indicates a situation in which harm, serious bodily injury or death could result if the warning is ignored.

CAUTION

A CAUTION indicates a situation in which damage to your vehicle could result if the caution is ignored.

NOTICE

A NOTICE indicates interesting or helpful information is being provided.

Table of Contents

Introduction	1
Your vehicle at a glance	2
Safety features of your vehicle	3
Features of your vehicle	4
Driving your vehicle	5
What to do in an emergency	6
Maintenance	7
Specifications, Consumer information and Reporting safety defects	8
Abbreviation	A
Index	I

Fuel requirements	1-2
Vehicle modifications	1-4
Vehicle break-in process	1-5
Risk of burns when parking or stopping vehicle.....	1-5
Vehicle data collection and Event Data Recorders.....	1-6
Vehicle handling instructions	1-7

INTRODUCTION

Fuel requirements

Your new vehicle is designed to use only unleaded fuel having a pump octane number $((R+M)/2)$ of 87 (Research Octane Number 91) or higher. (Do not use methanol blended fuels.)

Your new vehicle is designed to obtain maximum performance with UNLEADED FUEL, as well as minimize exhaust emissions and spark plug fouling.

Never add any fuel system cleaning agents to the fuel tank other than what has been specified. (Consult an authorized Kia dealer for details.)

- Tighten the cap until it clicks one time, otherwise the Check Engine



light will illuminate.

⚠ WARNING

Refueling

- Do not "top off" after the nozzle automatically shuts off. Attempts to force more fuel into the tank can cause fuel overflow onto you and the ground, causing a risk of fire.
- Always check that the fuel cap is installed securely to prevent fuel spillage, especially in the event of an accident.

Gasoline containing alcohol and methanol

Gasohol, a mixture of gasoline and ethanol (also known as grain alcohol), and gasoline or gasohol containing methanol (also known as wood alcohol) are being marketed along with or instead of leaded or unleaded gasoline.

Pursuant to Environmental Protection Agency (EPA) regulations, ethanol may be used in your vehicle.

Do not use gasohol containing more than 15% ethanol, and do not use gasoline or gasohol containing any methanol. Ethanol provides less energy than gasoline and attracts water. Thus, it is likely to reduce your fuel efficiency and could lower your MPG results.

Methanol may cause drivability problems and damage to the fuel system, engine control system and emission control system.

Discontinue using gasohol of any kind if drivability problems occur.

Vehicle damage or drivability problems may not be covered by the manufacturer's warranty if they result from the use of:

1. Gasoline or gasohol containing methanol.
2. Leaded fuel or leaded gasohol.
3. Gasohol containing more than 15% ethanol.

"E85" fuel is an alternative fuel comprised of 85% ethanol and 15% gasoline, and is manufactured exclusively for use in Flexible Fuel Vehicles. "E85" is not compatible with your vehicle. Use of "E85" may result in poor engine performance and damage to your vehicle's engine and fuel system. Kia recommends that customers do not use fuel with an ethanol content exceeding 15%.

* NOTICE

Your New Vehicle Limited Warranty does not cover damage to the fuel system or any performance problems caused by the use of "E85" fuel.

* NOTICE

Never use any fuel containing methanol. Discontinue use of any methanol containing products which may inhibit proper drivability.

Other fuels

Using fuels that contain Silicone (Si), MMT (Manganese, Mn), Ferrocene (Fe), and Other metallic additives, may cause vehicle and engine damage or cause misfiring, poor acceleration, engine stalling, catalyst melting, clogging, abnormal corrosion, life cycle reduction, etc.

Also, the Malfunction Indicator Lamp (MIL) may illuminate.

* NOTICE

Damage to the fuel system or performance problems caused by the use of these other fuels may not be covered by your New Vehicle Limited Warranty.

Gasoline containing MMT

Some gasoline contains harmful manganese- based fuel additives Such as MMT (Methylcyclopentadienyl Manganese Tricarbonyl). Kia does not recommend the use of gasoline containing MMT. This type of fuel can reduce vehicle performance and affect your emission control system. The Malfunction Indicator Lamp (MIL) on the cluster may come on.

Do not use methanol

Fuels containing methanol (wood alcohol) should not be used in your vehicle. This type of fuel can reduce vehicle performance and damage components of the fuel system, engine control system and emission control system.

Fuel Additives

Kia recommends that you use good quality gasolines treated with

detergent additives such as TOP TIER Detergent Gasoline, which help prevent deposit formation in the engine. These gasolines will help the engine run cleaner and enhance performance of the emission control system.

For more information on TOP TIER Detergent Gasoline, please go to the website (www.toptiergas.com) For customers who do not use TOP TIER Detergent Gasoline regularly, and have problems starting or the engine does not run smoothly, additives that you can buy separately may be added to the gasoline.

If TOP TIER Detergent Gasoline is not available, one bottle of additive should be added to the fuel tank at every 7,500 miles (12,000 km)(for Non Turbo engine)/6,000 miles (10,000 km)(for Turbo engine) or every engine oil change is recommended. Additives are available from your authorized Kia dealer along with information on how to use them. Do not mix other additives.

Operation in foreign countries

If you are going to drive your vehicle in another country, be sure to:

- Observe all regulations regarding registration and insurance.
- Determine that acceptable fuel is available.

Vehicle modifications

This vehicle should not be modified.

Modification of your vehicle could affect its performance, safety or durability and may even violate governmental safety and emissions regulations. In addition, damage or performance problems resulting from any modification may not be covered under warranty.

- If you use unauthorized electronic devices, it may cause the vehicle to operate abnormally, wire damage, battery discharge and fire.

For your safety, do not use unauthorized electronic devices.

Vehicle break-in process

No special break-in period is needed. By following a few simple precautions for the first 600 miles (1,000 km) you may add to the performance, economy and life of your vehicle.

- Do not race the engine.
- While driving, keep your engine speed (rpm, or revolutions per minute) between 2,000 rpm and 4,000 rpm.
- Do not maintain a single engine speed for long periods of time, either fast or slow. Varying engine speeds is needed to properly break-in the engine.
- Avoid hard stops, except in emergencies, to allow the brakes to seat properly.
- Don't tow a trailer during the first 1,200 miles (2,000 km) of operation.
- Fuel economy and engine performance may vary depending on vehicle break-in process and be stabilized after 4,000 miles (6,000 km). New engines may consume more oil during the vehicle break-in period.

Risk of burns when parking or stopping vehicle

- Do not park or stop the vehicle near flammable items such as leaves, paper, oil, and tire. Such items placed near the exhaust system can become a fire hazard.
- When an engine idles at a high rpm with the rear side of the vehicle in close proximity of the wall, heat of the exhaust gas can cause discoloration or fire. Keep enough space between the rear part of the vehicle and the wall.
- Be sure not to touch the exhaust/catalytic systems while the engine is running or right after the engine is turned off. There is a risk of burns since the systems are extremely hot.

Vehicle data collection and Event Data Recorders

This vehicle is equipped with an Event Data Recorder (EDR). The main purpose of an EDR is to record, in certain crash or near crash-like situations, such as an air bag deployment or hitting a road obstacle, data that will assist in understanding how a vehicle's systems performed. The EDR is designed to record data related to vehicle dynamics and safety systems for a short period of time, typically 30 seconds or less. The EDR in this vehicle is designed to record such data as:

- How various systems in your vehicle were operating;
- Whether or not the driver and passenger safety belts were buckled/ fastened;
- How far (if at all) the driver was depressing the accelerator and/or brake pedal; and,
- How fast the vehicle was traveling.

These data can help provide a better understanding of the circumstances in which crashes and injuries occur. NOTE: EDR data are recorded by your vehicle only if a non-trivial crash situation occurs; no data are recorded by the EDR under normal driving conditions and no personal data (e.g., name, gen-

der, age, and crash location) are recorded. However, other parties, such as law enforcement, could combine the EDR data with the type of personally identifying data routinely acquired during a crash investigation.

To read data recorded by an EDR, special equipment is required, and access to the vehicle or the EDR is needed. In addition to the vehicle manufacturer, other parties, such as law enforcement, that have the special equipment, can read the information if they have access to the vehicle or the EDR.

Vehicle handling instructions

As with other vehicles of this type, failure to operate this vehicle correctly may result in loss of control, an accident or vehicle rollover.

Specific design characteristics (higher ground clearance, track, etc.) give this vehicle a higher center of gravity than other types of vehicles. In other words they are not designed for cornering at the same speeds as conventional 2-wheel drive vehicles.

Avoid sharp turns or abrupt maneuvers. Again, failure to operate this vehicle correctly may result in loss of control, an accident or vehicle rollover.

Be sure to read the "Reducing the risk of a rollover" on page 5-182.

Exterior overview.....	2-2
Interior overview.....	2-5
Instrument panel overview	2-7
Engine compartment	2-9

YOUR VEHICLE AT A GLANCE

Exterior overview

Front view



OSP2N011001

* The actual shape may differ from the illustration.

- 1. Hood 4-35
- 2. Head lamp (Features of your vehicle) 4-98
 Head lamp (Maintenance) 7-72
- 3. Front fog lamp (Features of your vehicle)* 4-102
 Front fog lamp (Maintenance)* 7-76
- 4. Wheel and tire (Maintenance) 7-42
 Wheel and tire (Specification) 8-6
- 5. Outside rear view mirror 4-51
- 6. Sunroof* 4-41

7. Front windshield wiper blades (Features of your vehicle)	4-108
Front windshield wiper blades (Maintenance)	7-37
8. Windows	4-30
9. Front ultrasonic sensors*	4-93
10. Roof rack*	4-154
11. Front radar*	5-90
12. Front side marker lamp	7-78

*: if equipped

Rear view



OSP2N011002

* The actual shape may differ from the illustration.

1. Rear ultrasonic sensors*	4-90, 4-93
2. Door locks	4-20
3. Fuel filler door	4-37
4. Rear combination lamp (Maintenance)	7-71
5. High Mounted Stop Lamp (Maintenance)	7-79
6. Rear window wiper	4-109, 7-38
7. Liftgate	4-27
8. Rear view camera	4-89
9. Antenna	4-156

*: if equipped

Interior overview



OSP2N011004

* The actual shape may differ from the illustration.

1. Inside door handle	4-21
2. Central Door lock/unlock switch	4-22
3. Outside rear view mirror control	4-52
4. Power window switch	4-32
5. Power window lock switch	4-34
6. Fuel filler door open lever	4-37
7. Steering wheel	4-46
8. Tilt and telescopic steering control lever	4-47
9. Hood release lever	4-35
10. Inner fuse panel	7-57
11. Brake pedal	5-44
12. Seat	3-5
13. Instrument panel illumination control switch	4-54

14.Head-Up Display shutter On/Off button*	4-86
15.ISG Off button	5-67
16.Lane Safety button*	5-105
17.ESC Off button	5-58

*: if equipped

Instrument panel overview



OSP2N011003

* The actual shape may differ from the illustration.

- | | |
|-------------------------------------|--------------|
| 1. Audio remote control button | 4-156 |
| 2. Driver's front air bag | 3-56 |
| 3. Horn | 4-49 |
| 4. Driving Assist button* | 5-132, 4-58 |
| 5. Instrument cluster | 4-53 |
| 6. Light control/Turn signals lever | 4-99 |
| 7. Wiper and washer control lever | 4-106 |
| 8. ENGINE START/STOP button | 5-13 |
| 9. Audio, Video and Navigation* | 4-156 |
| 10. Hazard warning flasher | 6-3 |
| 11. Climate control system | 4-118, 4-124 |
| 12. Shift lever | 5-25, 5-36 |
| 13. AWD mode button* | 5-18 |

14.Drive mode integrated control system button	5-71
15.Front seat warmer and air ventilation seat button*	4-144, 4-145
16.Downhill Brake Control (DBC)*	5-64
17.Parking Safety button*	4-91, 4-93
18.Steering wheel heater button*	4-48
19.EPB switch*	5-48
20.Auto Hold button*	5-55
21.Center console storage box	4-138
22.USB charger*	4-146
23.Glove box	4-139
24.Passenger's front air bag	3-56

*: if equipped

Engine compartment

(Gasoline) 1.6 T-GDi

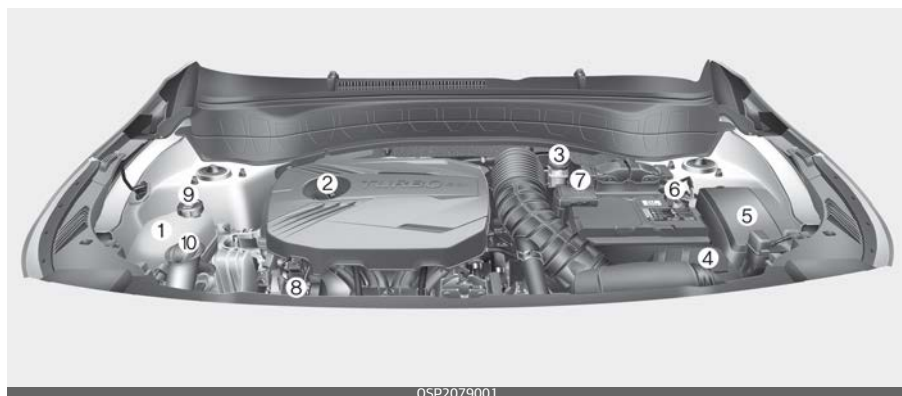

OSP2079001

* The actual engine room in the vehicle may differ from the illustration.

1. Engine coolant reservoir	7-27
2. Engine oil filler cap	7-24
3. Brake fluid reservoir	7-30
4. Air cleaner	7-33
5. Fuse box	7-58
6. Negative battery terminal	6-6, 7-39
7. Positive battery terminal	6-6, 7-39
8. Engine oil dipstick	7-24
9. Radiator cap	6-8, 7-27
10. Windshield washer fluid reservoir	7-31

(Gasoline) 2.0 MPI



OSP2079088L

* The actual engine room in the vehicle may differ from the illustration.

- | | |
|---------------------------------------|-----------|
| 1. Radiator cap | 6-8, 7-27 |
| 2. Engine oil filler cap | 7-24 |
| 3. Brake fluid reservoir | 7-30 |
| 4. Air cleaner | 7-33 |
| 5. Fuse box | 7-58 |
| 6. Negative battery terminal | 6-6, 7-39 |
| 7. Positive battery terminal | 6-6, 7-39 |
| 8. Engine oil dipstick | 7-24 |
| 9. Engine coolant reservoir | 7-27 |
| 10. Windshield washer fluid reservoir | 7-31 |

Important safety precautions	3-3
Seat	3-5
• Feature of Seat Leather	3-8
• Front seat adjustment for manual seat	3-8
• Front seat adjustment for power seat	3-10
• Headrest for front seat.....	3-11
• Seatback pocket (if equipped).....	3-14
• Headrest for rear seat	3-14
• Armrest.....	3-15
• Folding the rear seat.....	3-15
Seat belts	3-19
• Seat belt restraint system	3-19
• Driver's seat belt warning.....	3-21
• Front passenger's seat belt warning	3-21
• Seat belt - Driver's 3-point system with emergency locking retractor	3-22
• Seat belts - Front passenger and rear seat 3-point system with combination locking retractor	3-24
• Pre-tensioner seat belt.....	3-27
• Seat belt precautions.....	3-29
• Care of seat belts	3-31
Child Restraint System (CRS)	3-32
• Children always in the rear	3-32
• Selecting a CRS	3-34
• Installing a CRS.....	3-36
Air bag - advanced Supplemental Restraint System	3-43
• How does the air bag system operate?	3-44
• Do not install a child restraint on the front passenger's seat	3-45

3 Safety features of your vehicle

- Air bag warning light..... 3-46
- Supplemental Restraint System (SRS) components and functions 3-47
- Occupant Detection System (ODS)..... 3-49
- Driver's and passenger's front air bag..... 3-56
- Side air bag 3-58
- Curtain air bag..... 3-60
- Air bag collision sensors 3-62
- Why didn't my air bag go off in a collision? (Inflation and non-inflation conditions of the air bag)..... 3-63
- Supplemental Restraint System (SRS) care 3-67
- Adding equipment to or modifying your air bag-equipped vehicle 3-67
- Air bag warning label 3-68

SAFETY FEATURES OF YOUR VEHICLE

For the safety of the driver and vehicle passengers, you should become familiar with the vehicle's safety features.

Important safety precautions

You will find many safety precautions and recommendations throughout this section, and throughout this manual.

The safety precautions in this section are among the most important.

Always wear your seat belt

A seat belt is your best protection in all types of accidents. Air bags are designed to supplement seat belts, not replace them. So even though your vehicle is equipped with air bags, ALWAYS make sure you and your passengers wear your seat belts, and wear them properly.

Restrain all children

All children under age 13 should ride in your vehicle properly restrained in a rear seat, not the front seat. Infants and small children should be restrained in an appropriate child restraint. Larger children should use a booster seat with the lap/shoulder belt until they can use the seat belt properly without a booster seat.

Air bag hazards

While air bags can save lives, they can also cause serious or fatal injuries to occupants who sit too close to them, or who are not properly restrained. Infants, young children, and shorter adults are at the greatest risk of being injured by an inflating air bag. Follow all instructions and warnings in this manual.

Driver distraction

Driver distraction presents a serious and potentially deadly danger, especially for inexperienced drivers. Safety should be the first concern when behind the wheel and drivers need to be aware of the wide array of potential distractions, such as drowsiness, reaching for objects, eating, personal grooming, other passengers, and using cellular phones.

Drivers can become distracted when they take their eyes and attention off the road or their hands off the wheel to focus on activities other than driving. To reduce your risk of distraction or getting into an accident:

- ALWAYS set up your mobile devices (i.e., MP3 players, phones, navigation units, etc.) when your vehicle is parked or safely stopped.

- ONLY use your mobile device when allowed by laws and when conditions permit safe use. NEVER text or email while driving. Most states have laws prohibiting drivers from texting. Some states and cities also prohibit drivers from using handheld phones.
- NEVER let the use of a mobile device distract you from driving. You have a responsibility to your passengers and others on the road to always drive safely, with your hands on the wheel as well as your eyes and attention on the road.

Control your speed

Excessive speed is a major factor in crash injuries and deaths. Generally, the higher the speed, the greater the risk, but serious injuries can also occur at lower speeds. Never drive faster than is safe for current driving conditions, regardless of the maximum speed posted.

Keep your vehicle in safe condition

Having a tire blowout or a mechanical failure can be extremely hazardous. To reduce the possibility of such problems, check your tire pressures and conditions frequently, and perform all regularly scheduled maintenance.

Seat

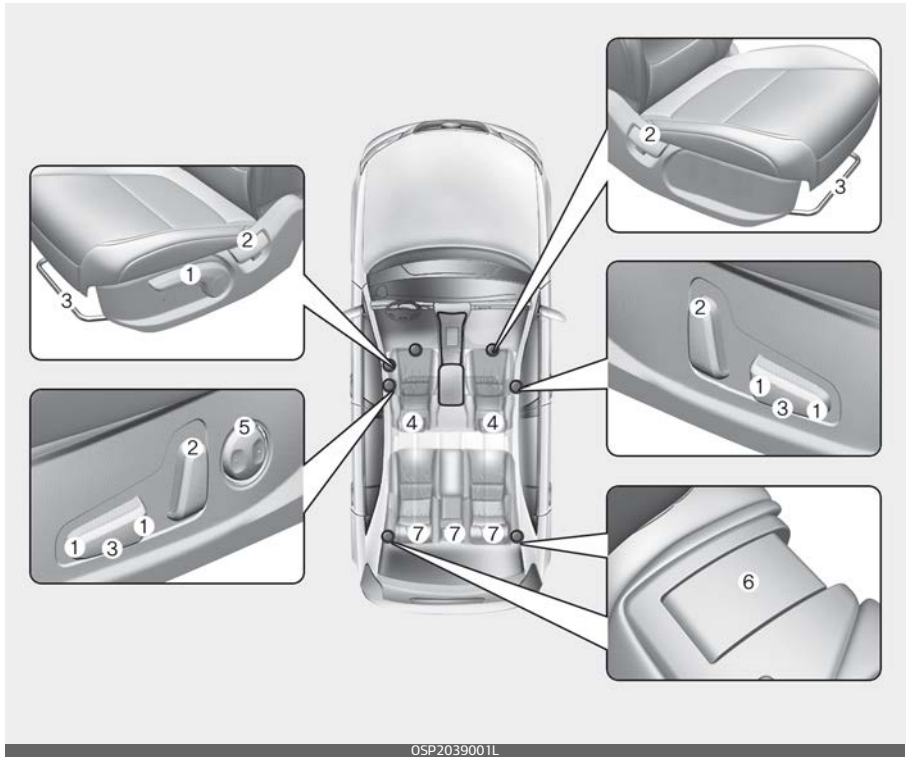

OSP2039001L

Front seat

1. Seat cushion height
2. Reclining: Back angle
3. Sliding: Forward and Backward
4. Headrest
5. Lumbar support*

Rear seat

6. Seat back folding/reclining adjustment
7. Headrest*

* : if equipped

⚠ WARNING

Loose objects

Loose objects in the driver's foot area could interfere with the operation of the foot pedals, possibly causing an accident. Do not place anything under the front seats.

⚠ WARNING**Uprighting seat**

Do not press the release lever on a manual seatback without holding and controlling the seatback. The seatback will spring upright, possibly impacting you or other passengers.

⚠ WARNING**Driver responsibility for passengers**

0DEEV058002NR

The driver must advise the passengers to keep the seatback in an upright position whenever the vehicle is in motion. If a seat is reclined during an accident, the restraint system's ability to restrain the passenger will be greatly reduced.

⚠ WARNING**Seat cushion**

Occupants should never sit on aftermarket seat cushions or sitting cushions. The passenger Occupant Detection System may not operate properly, or the passenger's hips may slide under the lap portion of the seat belt during an accident or a sudden stop.

⚠ WARNING**Driver's seat**

- Never attempt to adjust the seat while the vehicle is moving. This could result in loss of control of your vehicle.
- Do not allow anything to interfere with the normal position of the seatback. For example, storing items against the seatback could result in serious or fatal injury in a sudden stop or collision.
- Sit as far back as possible from the steering wheel while still maintaining comfortable control of the your vehicle. A distance of at least 10 in (25 cm) from your chest to the steering wheel is recommended. Failure to do so can result in air bag inflation injuries to the driver.

⚠ WARNING**Rear seatbacks**

Always lock the rear seatback before driving. Failure to do so could result in passengers or objects being thrown forward, injuring vehicle occupants.

⚠ WARNING**Unexpected Seat Movement**

After adjusting a manual seat, always check that it is locked by shifting your weight to the front and to the back. Sudden or unexpected movement of the driver's seat could cause you to lose control of the vehicle.

⚠ WARNING**Seat adjustment**

- Do not adjust the seat while wearing seat belts. Moving the seat forward will cause strong pressure on the abdomen.
 - Do not place your hand near the seat bottom or seat track while adjusting the seat. Your hand could get caught in the seat mechanism.
-

⚠ WARNING**Luggage and Cargo**

Do not stack or pile luggage or cargo higher than the seatback in the cargo area. In an accident the cargo could strike and injure a passenger. If objects are large, heavy or must be piled, they must be secured in the cargo area.

⚠ WARNING**Cargo Area**

Do not allow passengers to ride in the cargo area under any circumstance. The cargo area is solely for the purpose of transporting luggage or cargo.

⚠ WARNING**Small Objects**

Use extreme caution when picking up small objects trapped under the seats or between the seat and the center console. Your hands might be cut or injured by the sharp edges of the seats mechanism.

Feature of Seat Leather

- Wrinkles may appear as a natural result of stretching and shrinking depending on the temperature and humidity.
- The seat cover is made of stretchable material to improve comfort of passengers.
- The parts contacting the body are curved and the side supporting area is high which provides driving comfort and stability.

⚠ CAUTION

- Belts with metallic accessories, zippers or keys inside the back pocket may damage the seat fabric.
- Make sure not to wet the seat. It may change the nature of leather.
- Jeans or clothes which could bleed may contaminate the surface of the seat covering fabric.

* NOTICE

Wrinkles or abrasions may appear naturally from usage. It is not a fault of product. Wrinkles or abrasions are not covered by warranty.

Front seat adjustment for manual seat

The front seat can be adjusted by using the control levers located on the outside of the seat cushion.



Moving forward and backward

Adjust the seat before driving, and make sure the seat is locked securely by trying to move forward and backward without using the lever. If the seat moves, it is not locked properly.

To move the seat forward or backward:

1. Pull the seat slide adjustment lever up and hold it.
2. Slide the seat to the position you desire.
3. Release the lever and make sure the seat is locked in place.

Reclining seatback

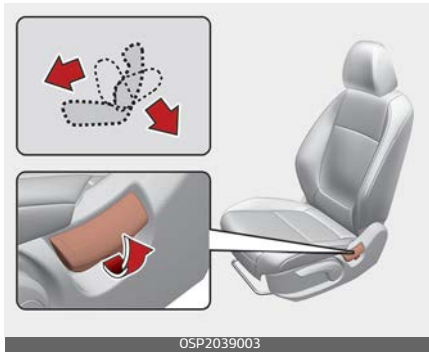

To recline the seatback:

1. Lean forward slightly and lift up the seatback recline lever.
2. Carefully lean back on the seat and adjust the seatback of the seat to the position you desire.
3. Release the lever and make sure the seatback is locked in place. (The lever **MUST** return to its original position for the seatback to lock.)

⚠ WARNING

Reclining seatback

Sitting in a reclined position when the vehicle is in motion can be dangerous. Even with the seat belt fastened, the protections of your restraint system (seat belts and/or air bags) is greatly reduced by reclining your seatback.

Seat belts must be snug against your hips and chest to work properly. When the seatback is reclined, the shoulder belt cannot do its job because it will not be snug against

your chest. Instead, it will be in front of you. During an accident, you could be thrown into the seat belt, causing neck or other injuries.

The more the seatback is reclined, the greater chance the passenger's hips will slide under the lap belt or the passenger's neck will strike the shoulder belt.

Changing seat cushion height (if equipped)

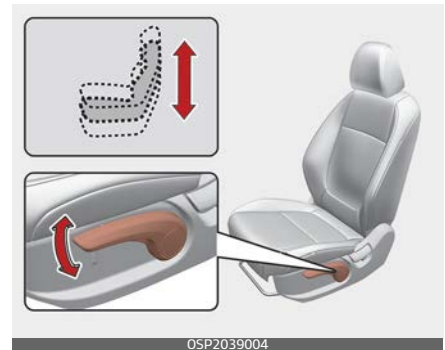

To change the height of the seat cushion, push the lever upwards or downwards.

- To lower the seat cushion, push down the lever several times.
- To raise the seat cushion, pull up the lever several times.

Front seat adjustment for power seat (if equipped)

The front seat can be adjusted by using the control switches located on the outside of the seat cushion.

Before driving, adjust the seat to the proper position so you can easily control the steering wheel, pedals and switches on the instrument panel.

⚠ CAUTION

Power seating adjustments

- The power seating controls function by electronic motor. Excessive operation may cause damage to the electrical equipment.
- Do not operate two or more power seat control switches at the same time. Doing so may damage the power seat motor or electrical components.

Moving forward and backward

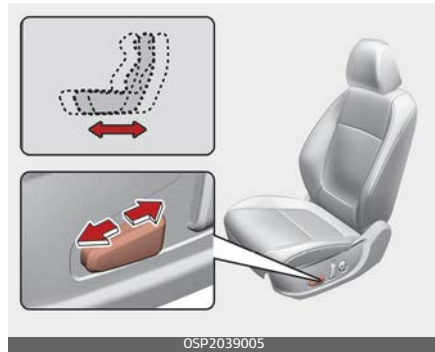

To move the seat forward or backward:

1. Push the control switch forward or backward to move the seat to the desired position.
2. Release the switch once the seat reaches the desired position.

Reclining seatback

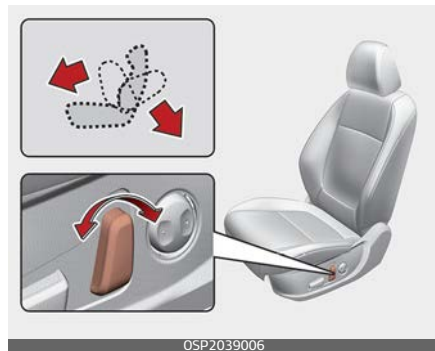

To recline the seatback:

1. Push the control switch forward or backward to move the seatback to the desired angle
2. Release the switch once the seat reaches the desired position.

Changing seat cushion tilt and height

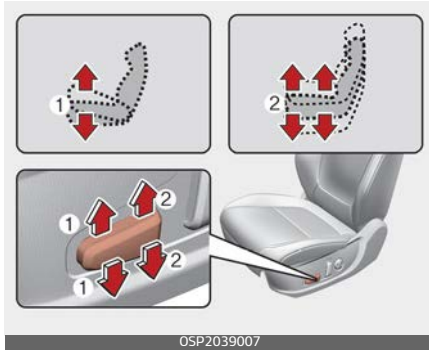

To change the height of the seat:

1. Pull the front portion (1) of the control switch up to raise or press down to lower the front part of the seat cushion.
2. Pull the rear portion (2) of the control switch up to raise or press down to lower the back part of the seat cushion.
3. Release the switch once the seat reaches the desired position.

Adjusting lumbar support for driver's seat (if equipped)

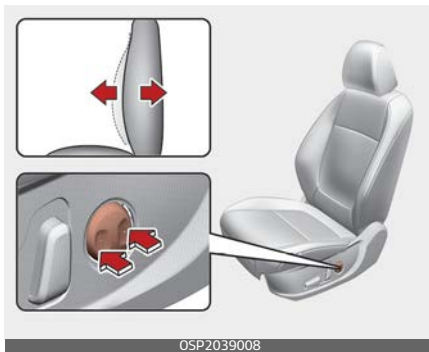

The lumbar support can be adjusted by pressing the lumbar support switch on the side of the seat.

1. Press the front portion of the switch to increase support, or the rear portion of the switch, to decrease support.
2. Release the switch once it reaches the desired position.

Headrest for front seat

The driver's and front passenger's seats are equipped with a headrest for the occupant's safety and comfort.



The headrest not only provides comfort for the driver and front passenger, but also helps protect the head and neck in the event of a rear collision.

For maximum effectiveness in case of an accident, the headrest should be adjusted so the middle of the headrest is as high as the center of gravity of an occupant's head. Generally, the center of gravity of most

people's head is similar with the height of the top of their eyes.

Also, adjust the headrest as close to your head as possible. For this reason, the use of a cushion that holds the body away from the seatback is not recommended.

⚠ WARNING

Headrest removal/adjustment

- Do not operate the vehicle with the headrests removed. Headrests can provide critical neck and head support in a crash.
- Do not adjust the headrest height while the vehicle is in motion. Driver may lose control of the vehicle.

⚠ CAUTION

Excessive pulling or pushing may damage the headrest.

Adjusting the height up and down

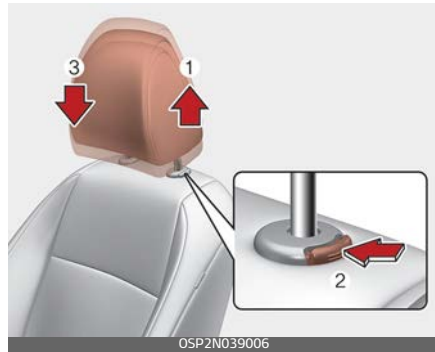

To raise the headrest:

1. Pull it up to the desired position (1).
2. To lower the headrest, push and hold the release button (2) on the headrest support.
3. Lower the headrest to the desired position (3).

*** NOTICE**

If you recline the seatback towards the front with the headrest and seat cushion raised, the headrest may come in contact with the sun visor or other parts of the vehicle.



Removing headrest

Type A

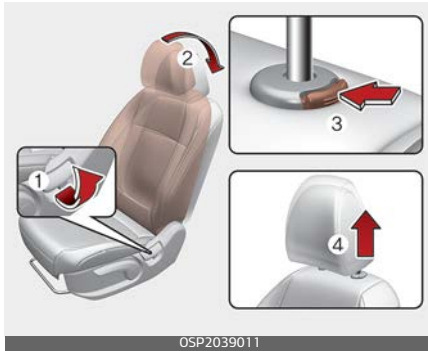

OSP2039011

Type B

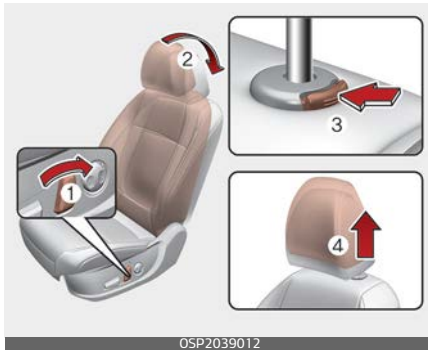

OSP2039012

To remove the headrest:

1. Recline the seatback (2) with the recline lever or switch (1).
2. Raise headrest as far as it can go.
3. Press the headrest release button (3) while pulling the headrest up (4).

⚠ WARNING

Removing headrest

NEVER allow anyone to ride in a seat with the headrest removed or reversed. Headrests can provide critical neck and head support in a crash.

Reinstalling headrest

Type A

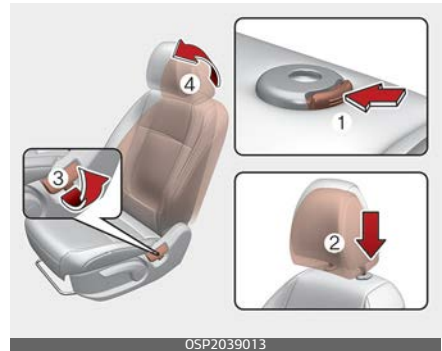

OSP2039013

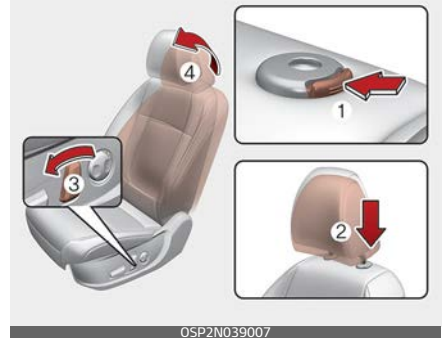

OSP2N039007

To reinstall the headrest:

1. Put the headrest poles (2) into the holes while pressing the release button (1).

2. Recline the seatback (4) with the recline lever or switch (3).
3. Adjust the headrest to the appropriate height.

⚠ WARNING

Headrest Reinstallation

To reduce the risk of injury to the head or neck, always make sure the headrest is locked into position and adjusted properly after reinstalling.

Seatback pocket (if equipped)

The seatback pocket is provided on the back of the front passenger's seatbacks.



⚠ WARNING

Seatback pockets

Do not put heavy or sharp objects in the seatback pockets. In an accident they could come loose from the pocket and injure vehicle occupants.

Headrest for rear seat

The rear seat is equipped with headrests in all the seating positions for the occupant's safety and comfort.



The headrest not only provides comfort for passengers, but also helps protect the head and neck in the event of a collision.

To maximize the effectiveness in case of accidents, the headrest should be adjusted so the middle of the headrest is as high as the center of gravity of an occupant's head. Generally, the center of gravity of most people's heads is similar with the height as the top of their eyes.

Also, adjust the headrest as close to your head as possible. For this reason, the use of a cushion that holds the body away from the seatback is not recommended.

Adjusting the height up and down (if equipped)

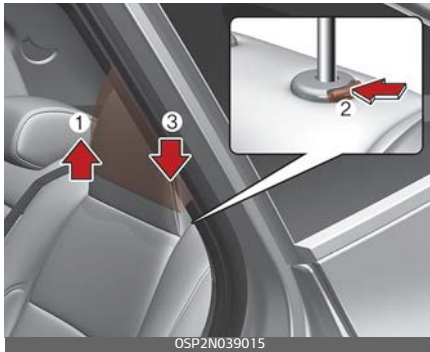

- To raise the headrest, pull it up to the desired position (1).
- To lower the headrest, push and hold the release button (2) on the headrest support and lower the headrest to the desired position (3).

Removal and reinstallation (if equipped)

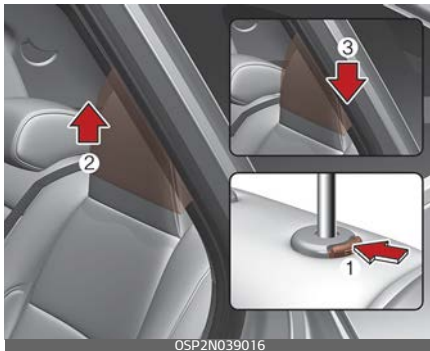

- To remove the headrest, raise it as far as it can go then press the release button (1) While pulling the headrest upward (2).

- To reinstall the headrest, put the headrest poles (3) into the holes while pressing the release button (1).

Then adjust it to the appropriate height and ensure that it locks in position.

Armrest (if equipped)



To use the armrest, pull it forward from the seatback.

Folding the rear seat

The rear seatbacks may be folded to facilitate carrying long items or to increase the luggage capacity of the vehicle.

⚠ WARNING

Folded Seatback

The purpose of the fold-down rear seatbacks is to allow you to carry longer objects that could not otherwise be accommodated.

- Never allow a passenger to sit on top of the folded down seatback while the car is moving. This is not a proper seating position since no seat belts are available for use. This could result in serious injury or death, for example, in case of an accident or sudden stop.

⚠ WARNING

When folding the seatback, be sure to hold the seatback or headrest with your hands.

⚠ CAUTION

When folding or unfolding a rear seat, make sure to lower the seat's headrest as much as possible and put the front seat's seatback in the upright position.

If there is any interference when folding or unfolding the seat, the interfered area of the seat may be damaged.

Folding down the rear seatback

1. Set the front seatback to the upright position and, if necessary, slide the front seat forward.
2. Lower the rear headrests to the lowest position.

⚠ WARNING

Objects

Objects carried on the folded down seatback should not extend higher than the top of the front seatbacks. Otherwise, cargo may slide forward and cause injury or damage during sudden stops.

3. When folding the seatback, insert the rear seat belt buckle in the pocket between the rear seatback and cushion. Make sure both seat belts do not interfere with stowed luggage and cargo. Then, the seat belt webbing should be placed in the webbing guide to prevent the seat belt from being damaged by loaded cargo, etc. If the seat belt is loose, it may cause damage or noise. In that case, return the seatback to the upright position and put the webbing out from the guide to realign it.

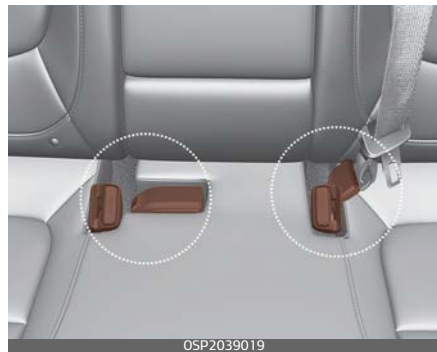



4. Pull on the seatback folding lever, then fold the seat toward the front of the vehicle. When you return the seatback to its upright position, always be sure it has locked into position by pushing on the top of the seatback.



Unfolding the rear seat



1. To use the rear seat, lift and pull the seatback backward. Pull the seatback firmly until it clicks into place. Make sure the seatback is locked in place. When you return the seatback to its upright position, always be sure it has locked into position by pushing on the top of the seatback.
2. Return the rear seat belt to the proper position.
3. When the seatback is completely installed, check the seatback folding lever again.
4. If you want to tilt the rear seatback a bit more, while pulling on the seatback folding lever and push the top of the rear seatback towards the rear. Then release the lever and make sure that the rear seat is firmly locked.

⚠ WARNING**Uprighting seat**

When you return the seatback to its upright position, hold the seatback and return it slowly. If the seatback is returned without holding it, the back of the seat could spring forward, resulting in injury caused by being struck by the seatback.

⚠ WARNING**Rear seatback**

To ensure maximum protection in the event of an accident or sudden stop, when returning the rear seat to the upright position:

- Be careful not to damage the seat belt webbing or buckle.
- Do not allow the seat belt webbing or buckle to become pinched or caught in the rear seat.
- Ensure the seatback is completely locked into its upright position by pushing on the top of the seatback.

Failure to adhere to any of these instructions could result in serious injury or death in the event of a crash.

⚠ CAUTION**Damaging rear seat belt buckles**

When you fold the rear seatback, insert the buckle between the rear seatback and cushion. Doing so can prevent the buckle from being damaged by the rear seatback.

⚠ CAUTION**Rear seat belts**

When returning the rear seatbacks to the upright position, remember to return the rear shoulder belts to their proper position.

⚠ WARNING

Unless the driver's position is properly set according to the driver's physical figure, do not fold the rear seat. It may increase bodily injuries in a sudden stop or collision.

⚠ CAUTION

Be careful when loading cargo through the rear passenger seats to prevent damage to the vehicle interior.

⚠ WARNING**Cargo**

Cargo should always be secured to prevent it from being thrown about the vehicle in a collision and causing injury to the vehicle occupants. Do not place objects in the rear seats, since they cannot be properly secured and may hit the front seat occupants in a collision.

Cargo loading

Make sure the engine is off, the transmission is in P (Park) and the parking brake is securely applied whenever loading or unloading cargo. Failure to take these steps may allow the vehicle to move if the shift lever is inadvertently moved to another position.

Seat belts

Seat belts are designed to bear upon the bony structure of the body, and should be worn low across the front of the pelvis, chest and shoulders.

Seat belt restraint system

For maximum restraint system protection, the seat belts must always be used whenever the vehicle is moving.

- A properly positioned shoulder belt should be positioned midway over your shoulder, across your collarbone.
- Never allow children to ride in the front passenger seat. See "Child Restraint System (CRS)" on page 3-32 for further discussion.

⚠ WARNING**Twisted seat belt**

Make sure your seat belt is not twisted when worn. A twisted seat belt may not properly protect you in an accident and could even cut into your body.

⚠ WARNING**Shoulder Belt**

- Never wear the shoulder belt under your arm or behind your back. An improperly positioned shoulder belt cannot protect the occupant in the event of a crash.
- Always wear both the shoulder portion and lap portion of the lap/shoulder belt.

⚠ WARNING**Damaged seat belt**

Any damage in webbing or hardware may lead to serious injury or death in a crash. For your safety, replace the entire seat belt assembly when any part of the webbing or hardware is damaged.

Seat belts are designed to bear upon the bony structure of the body, and should be worn low across the front of the pelvis, chest and shoulders, as applicable; wearing the lap section of the belt across the abdominal area must be avoided.

Seat belts should be adjusted as firmly as possible, consistent with comfort, to provide the protection for which they have been designed.

A slack belt will greatly reduce the protection afforded to the wearer.

Care should be taken to avoid contamination of the webbing with polishes, oils and chemicals, and particularly battery acid. Cleaning may safely be carried out using mild soap and water. The belt should be replaced if webbing becomes frayed, contaminated or damaged.

- No modifications or additions should be made by the user which would either prevent the seat belt adjusting devices from operating to remove slack, or prevent the seat belt assembly from being adjusted to remove slack.
- When you fasten the seat belt, be careful not to latch the seat belt in buckles of other seats. It is very dangerous and you may not be protected by the seat belt properly.
- Do not unfasten the seat belt and do not fasten and unfasten the seat belt repeatedly while driving. This could result in loss of control, and an accident causing death, serious injury, or property damage.
- When fastening the seat belt, make sure that the seat belt does not pass over objects that are hard or can break easily.

⚠ WARNING**Seat belt buckle**

Do not allow foreign material (gum, crumbs, coins, liquids, etc.) to obstruct the seat belt buckle. This may prevent the seat belt from fastening securely.

Driver's seat belt warning

As a reminder to the driver, the driver's seat belt warning lights will illuminate for approximately 6 seconds each time you turn the ENGINE START/STOP button ON regardless of belt fastening. If the seatbelt is not fastened, the warning chime will sound for about 6 seconds.



If you start to drive without the seat belt fastened over 5 mph (9 km/h) and less than 12 mph (20 km/h), the corresponding warning light will illuminate. The warning light will turn off when the vehicle speed drops below 5 mph (9 km/h).

If you start to drive without the seat belt fastened or you unfasten the seat belt when you drive 12 mph (20 km/h) and faster, the warning light will blink and warning chime will sound for approximately 100 seconds. When the seat belt is unfastened during driving, the warning light will illuminate when the speed is under 12 mph (20 km/h). When the speed is 12 mph (20 km/h) and faster, the warning light will blink and warning chime will sound for approximately 100 seconds.

Front passenger's seat belt warning

As a reminder to the front passenger, the front passenger's seat belt warning lights will illuminate for approximately 6 seconds each time you turn the ENGINE START/STOP button ON regardless of belt fastening. If you start to drive without the passenger seat belt fastened when you drive over 5 mph (9 km/h) and less than 12 mph (20 km/h), the corresponding warning light will illuminate. The warning light will turn off when the vehicle speed drops below 5 mph (9 km/h).



If you start to drive without the passenger seat belt fastened or you unfasten the seat belt when you drive 12 mph (20 km/h) and faster, the warning light will blink and warning chime will sound for approximately 100 seconds. When the passenger seat belt is unfastened during driving, the warning light will illuminate when the speed is under 12 mph (20 km/h). When the speed is 12 mph (20 km/h) and faster, the warning light will blink and warning chime will sound for approximately 100 seconds.

*** NOTICE**

- Even if the front passenger seat is not occupied, the seat belt warning light will illuminate for 6 seconds.
- The front passenger's seat belt warning may operate when luggage is placed on the front passenger seat.

Seat belt - Driver's 3-point system with emergency locking retractor

The following explains how to fasten and adjust the driver's seat belt.

Fastening your seat belt:

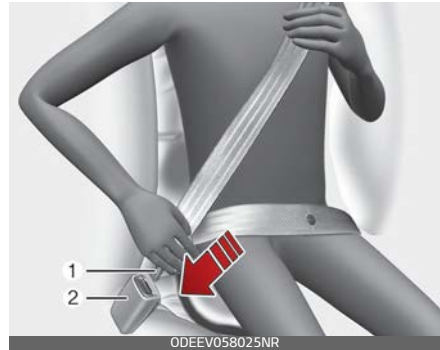

- Pull it out of the retractor and insert the metal tab (1) into the buckle (2). There will be an audible "click" when the tab locks into the buckle.



⚠ WARNING

You should place the lap belt portion as low as possible and snugly across your hips. If the lap belt is located too high on your waist, it may increase the chance of injury in the event of a collision.

The arm closest to the seat belt buckle should be over the belt while the other arm should be under the belt as shown in the illustration.

Never wear the seat belt under the arm closest to the door.

The seat belt automatically adjusts to the proper length only after the lap belt portion is adjusted manually so that it fits snugly around your hips. If you lean forward in a slow, easy motion, the belt will extend and let you move around. If there is a sudden stop or impact, however, the belt will lock into position. It will also lock if you try to lean forward too quickly.

*** NOTICE**

If you are not able to pull out the seat belt from the retractor, firmly pull the belt out and release it. Then you will be able to pull the belt out smoothly.

Adjusting the height of shoulder belt

You can adjust the height of the shoulder belt anchor to one of the 4 positions for maximum comfort and safety.

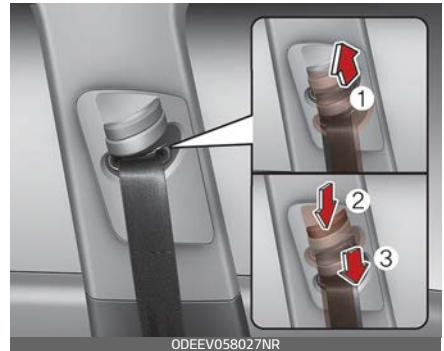

The height of the adjusting seat belt should not be too close to your neck. The shoulder portion should be adjusted so that it lies across your chest and midway over your shoulder near the door and not your neck.

To adjust the height of the seat belt anchor, lower or raise the height adjuster into an appropriate position.

- To raise the height adjuster, pull it up (1).
- To lower it, push it down (3) while pressing the height adjuster button (2).

Release the button to lock the anchor into position. Try sliding the height adjuster to make sure that it has locked into position.

Improperly positioned seat belts can cause serious injuries in an accident.

⚠ WARNING

Shoulder belt positioning

Verify the shoulder belt anchor is locked into position at the appropriate height. Never position the shoulder belt across your neck or face. Improperly positioned seat belts can cause serious injuries in an accident.

⚠ WARNING

Seat belt replacement

Replace your seat belts after being in an accident. Failure to replace seat belts after an accident could leave you with damaged seat belts that will not provide protection in the event of another collision.

Seat belts – Front passenger and rear seat 3-point system with combination locking retractor

The following explains how to fasten the passenger's and rear seat belts.

Fastening your seat belt:

Combination retractor type seat belts are installed in the rear seat positions to help accommodate the installation of Child Restraint System. Although a combination

retractor is also installed in the front passenger seat position, it is strongly recommended that children always be seated in the rear seat. NEVER place any infant restraint system in the front seat of the vehicle.

This type of seat belt combines the features of both an emergency locking retractor seat belt and an automatic locking retractor seat belts.

- Pull it out of the retractor and insert the metal tab into the buckle. There will be an audible "click" when the tab locks into the buckle. When not securing a child restraint, the seat belt operates in the same way as the driver's seat belt (emergency locking retractor type).

It automatically adjusts to the proper length only after the lap belt portion of the seat belt is adjusted manually so that it fits snugly around your hips.

When the seat belt is fully extended from the retractor to allow the installation of a Child Restraint System, the seat belt operation changes to allow the belt to retract, but not to extend (automatic locking retractor type). Refer to "Securing a child restraint with a lap/shoulder belt" on page 3-40.

* NOTICE

Although the combination retractor provides the same level of protection for seated passengers in either emergency or automatic locking modes, have the seated passengers use the emergency locking feature for improved convenience. The automatic locking function is intended to facilitate child restraint installation. To convert from the automatic locking feature to the emergency locking operation mode, allow the unbuckled seat belt to fully retract.

⚠ CAUTION

Do NOT fold down the left portion of the rear seatback when the rear center seat belt is buckled. ALWAYS UNBUCKLE the rear center seat belt before folding down the left portion of the rear seatback. If the rear center seat belt is buckled when the left portion of the rear seatback is folded down, distortion and damage to the top portion of the seatback and seat belt garnish may result, causing the seatback to lock into the folded down position.

The seat belt should be locked into the buckle on each seat cushion to be properly fastened.



1. Rear right seat belt fastening buckle
2. Rear center seat belt fastening buckle
3. Rear left seat belt fastening buckle

⚠ WARNING

Prior to fastening the rear seat belts, ensure the latch matches the seat belt buckle. Forcefully fastening the left or right seat belt to the center buckle can result in an improper fastening scenario that will not protect you in an accident.

When using the rear center seat belt, the buckle with the "CENTER" mark must be used.

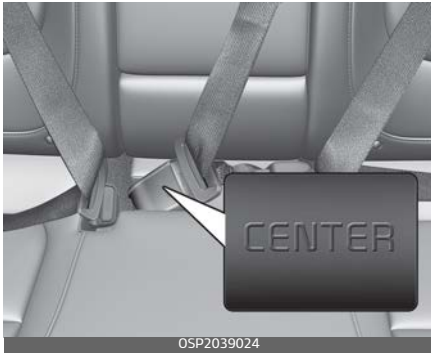

OSP2039024

Stowing the rear seat belt

The rear seat belt buckles can be stowed in the pocket between the rear seatback and cushion when not in use.



OSP21039018

1. Route the seat belt webbing through the rear seat belt guides. It will help keep the belts from being trapped behind or under the seats.
2. After inserting the seat belt, tighten the belt webbing by pulling it up.

⚠ CAUTION

When pulling out to wear the seat belt, the tongue should be slowly pulled out of the seat belt guide so that the seat belt guide does not come off the trim.

⚠ WARNING

Rear center seat belt



OSP2039025

Do not separate the mini tongue (1) and mini buckle (2) even if there is not an occupant.

If it is separated, it may hit the rear seat occupants in a collision or sudden stops.

Releasing the seat belt:



- The seat belt is released by pressing the release button (1) on the locking buckle. When it is released, the belt should automatically draw back into the retractor. If this does not happen, check the belt to make sure it is not twisted, then try again.

Pre-tensioner seat belt

Your vehicle is equipped with driver's and front passenger's pre-tensioner seat belts (retractor pre-tensioner and EFD (Emergency Fastening Device)).



The pre-tensioner seat belts may be activated, when a frontal collision is severe enough, together with the air bags.

When the vehicle stops suddenly, or if the occupant tries to lean forward too quickly, the seat belt retractor may lock into position. In certain frontal collisions, the pre-tensioner will activate and pull the seat belt into tighter contact against the occupant's body.

1. Retractor Pre-tensioner

The purpose of the retractor pre-tensioner is to make sure that the shoulder belts fit in tightly against the occupant's upper body in certain frontal collisions.

2. EFD (Emergency Fastening Device)

The purpose of the EFD is to make sure that the pelvic belts fit in tightly against the occupant's lower body in certain frontal collisions.

If the system senses excessive tension on the driver or passenger's seat belt when the pre-tensioner system activates, the load limiter inside the retractor pre-tensioner will release some of the pressure on the affected seat belt.

* NOTICE

When the pre-tensioner seat belts are activated, a loud noise may be heard and fine dust, which may appear to be smoke, may be visible in the passenger compartment. These are normal operating conditions and are not hazardous.

The seat belt pre-tensioner system consists mainly of the following components. Their locations are shown in the illustration:



* The actual position of seat belt pre-tensioner system components may differ from the illustration.

1. SRS air bag warning light
2. Retractor pre-tensioner assembly
3. SRS control module
4. Emergency fastening device (EFD)

⚠ WARNING

Skin Irritation

Wash all exposed skin areas thoroughly after an accident in which the pre-tensioner seat belts were activated. The fine dust from the pre-tensioner activation may cause skin irritation and should not be inhaled for prolonged periods.

* NOTICE

- Both the driver's and front passenger's seat belt pre-tensioner systems may be activated not only in certain frontal collisions, but also in certain side collisions or rollovers, if the vehicle is equipped with a side or curtain air bag.
- Because the sensor that activates the SRS air bag is connected with the pre-tensioner seat belt, the SRS air bag warning light  on the instrument panel will illuminate for approximately 6 seconds after the ignition switch has been turned to the ON position, and then it should turn off.
- If the pre-tensioner seat belt system is not working properly, this warning light will illuminate even if there is not a malfunction with the SRS air bag. If the SRS air bag warning light does not illuminate when the ignition switch has been

turned to the ON position, or if it remains illuminated after illuminating for approximately 6 seconds, or if it illuminates while the vehicle is being driven, have an authorized Kia dealer inspect the pre-tensioner seat belt and SRS air bag system as soon as possible.

* NOTICE

Do not attempt to service or repair the pre-tensioner seat belt system in any manner. Do not attempt to inspect or replace the pre-tensioner seat belts yourself. This must be done by an authorized Kia dealer.

⚠ WARNING

Hot pre-tensioner

Do not touch the pre-tensioner seat belt assemblies for several minutes after they have been activated. When the pre-tensioner seat belt mechanism fires during a collision the pre-tensioner becomes hot and can burn you.

Pre-tensioners are designed to operate only one time. After activation, pre-tensioner seat belts must be replaced. If the pre-tensioner must be replaced, contact an authorized Kia dealer.

Seat belt precautions

Take the following precautions when using seat belts.

Infant or small child

All 50 states have child restraint laws. You should be aware of the specific requirements in your state. Child and/or infant seats must be properly placed and installed in the rear seat. For more information about the use of these restraints, refer to "Child Restraint System (CRS)" on page 3-32.

* NOTICE

Small children are best protected from injury in an accident when properly restrained in the rear seat by a Child Restraint System that meets the requirements of the Federal Motor Vehicle Safety Standards (FMVSS). Before buying any Child Restraint System, make sure that it has a label certifying that it meets Federal Motor Vehicle Safety Standard 213. The restraint must be appropriate for your child's height and weight. Check the label on the child restraint for this information. Refer to "Child Restraint System (CRS)" on page 3-32.

Larger children

Children who are too large for Child Restraint System should always occupy the rear seat and use the available lap/shoulder belts. The lap portion should be fastened and snug on the hips as low as possible. Check periodically to insure that the belt fits. A child's squirming could put the belt out of position. Children are given the most safety in the event of an accident when they are restrained by a proper restraint system in the rear seat. If a larger child (over age 13) must be seated in the front seat, the child should be securely restrained by the available lap/shoulder belt and the seat should be placed in the rearmost position. Children age 13 and under should be restrained securely in the rear seat. NEVER place a child age 13 and under in the front seat. NEVER place a rear facing child seat in the front seat of a vehicle.

If the shoulder belt portion slightly touches the child's neck or face, try placing the child closer to the center of the vehicle. If the shoulder belt still touches their face or neck they need to be returned to a Child Restraint System.

⚠ WARNING

Small children

Do not allow small children to ride in the vehicle without an appropriate Child Restraint System. If the shoulder belt comes in contact with your child's neck or face, your child is too small to ride in the vehicle. In a crash, the seat belt will inflict injury to your child's neck, throat and face.

Restraint of pregnant women

Pregnant women should wear lap/shoulder belt assemblies whenever possible according to specific recommendations by their doctors. The lap portion of the belt should be worn AS SECURELY AND LOW AS POSSIBLE.

⚠ WARNING

Pregnant women

Pregnant women must never place the lap portion of the seat belt above or on the abdomen where the fetus is located. The force of the seat belt during a collision will crush the fetus.

Injured person

A seat belt should be used when an injured person is being transported. When this is necessary, you should consult a physician for recommendations.

One person per belt

Two people (including children) should never attempt to use a single seat belt. This could increase the severity of injuries in case of an accident.

Do not lie down

To reduce the chance of injuries in the event of an accident and to achieve maximum effectiveness of the restraint system, all passengers should be sitting up and the front and rear seats should be in an upright position when the vehicle is moving. A seat belt cannot provide proper protection if the person is lying down in the rear seat or if the front and rear seats are in a reclined position.

Care of seat belts

Seat belt systems should never be disassembled or modified. In addition, care should be taken to assure that seat belts and belt hardware are not damaged by seat hinges, doors or other abuse.

⚠ WARNING

Pinched seat belt

Make sure that the webbing and/or buckle does not get caught or pinched in the rear seat when returning the rear seatback to its upright position. A caught or pinched webbing/buckle may become damaged and could fail during a collision or sudden stop.

⚠ WARNING

Seatbelts can become hot in a vehicle that has been closed up in sunny weather. Please handle with care, as they could burn infants and children, if used abruptly.

Periodic inspection

All seat belts should be inspected periodically for wear or damage of any kind. Any damaged parts should be replaced as soon as possible.

Keep belts clean and dry

Seat belts should be kept clean and dry. If belts become dirty, they can be cleaned by using a mild soap solution and warm water. Bleach, dye, strong detergents or abrasives should not be used because they may damage and weaken the fabric.

When to replace seat belts

The entire in-use seat belt assembly or assemblies should be replaced if the vehicle has been involved in an accident. This should be done even if no damage is visible. Additional questions concerning seat belt operation should be directed to an authorized Kia dealer.

Child Restraint System (CRS)

Infants and younger children must be restrained in an appropriate rear-facing or forward-facing Child Restraint System (CRS) that has first been properly secured to the rear seat of the vehicle.

Children always in the rear

Children under age 13 must always ride in the rear seats and must always be properly restrained to minimize the risk of injury in an accident, sudden stop or sudden maneuver.

⚠ WARNING**Restraint Location**

Never install a child or infant seat on the front passenger's seat. A child riding in the front passenger seat can be forcefully struck by an inflating airbag and get seriously injured.

⚠ WARNING**Hot Child Restraint**

A Child Restraint System can become very hot if it is left in a closed vehicle on a sunny day. Be sure to check the seat cover, buckles and latches before placing a child in the restraint system.

According to accident statistics, children are safer when properly restrained in the rear seats than in the front seat. Even with air bags, children can be seriously injured or killed. Children too large for a child restraint must use the seat belts provided.

All 50 states have child restraint laws which require children to travel in approved child restraint devices. The laws governing the age or height/weight restrictions at which seat belts can be used instead of child restraints differs among states, so you should be aware of the specific requirements in your state, and where you are travelling.

The CRS must be properly placed and installed in the rear seat. You must use a commercially available CRS that meets the requirements of the Federal Motor Vehicle Safety Standards (FMVSS).

A CRS is generally designed to be secured in a vehicle seat by lap belt portion of a lap/shoulder belt, or by a LATCH system in the rear seats of the vehicle.

Child Restraint System (CRS)

Infants and younger children must be restrained in an appropriate rear-facing or forward-facing CRS that has first been properly secured to the rear seat of the vehicle. Read and comply with the instructions for installation and use provided by the manufacturer of the CRS.

⚠ WARNING

Child Restraint Installation

An improperly secured child restraint can increase the risk of serious injury or death in an accident. Always take the following precautions when using a Child Restraint System:

- Always follow the Child Restraint System manufacturer's instructions for installation and use.
- Always properly restrain your child in the child restraint.
- If the vehicle head restraint prevents proper installation of a child seat (as described in the Child Restraint System manual), the head restraint of the respective seating position shall be readjusted or entirely removed.
- Do not use an infant carrier or a child safety seat that "hooks" over a seatback as it may not provide adequate protection in an accident.
- A child restraint in the center seating position may also contact

or push up against the safety belt buckles, which can damage the buckles and make them unusable or unsafe. Always check that the child restraint does not contact any of the safety belt buckles. Check the placement of the child restraint regularly to make sure that it has not shifted and come into contact with any of the safety belt buckles.

* NOTICE

After an accident, have a Kia dealer check the Child Restraint System, seat belts, tether anchors and lower anchors.

Selecting a CRS

When selecting a CRS for your child, always:

- Make sure the CRS has a label certifying that it meets applicable Federal Motor Vehicle Safety Standards (FMVSS 213).
- Select a child restraint based on your child's height and weight. The required label or the instructions for use typically provide this information.
- Select a child restraint that fits the vehicle seating position where it will be used.
- Read and comply with the warnings and instructions for installa-

tion and use provided with the CRS.

⚠ WARNING

Holding Children

Never hold a child in your arms or lap when riding in a vehicle. The violent forces created during a crash will tear the child from your arms and throw the child against the car's interior. Always use a Child Restraint System which is appropriate for your child's height and weight.

⚠ WARNING

Unattended Children

Never leave children unattended in a vehicle. The car can heat up very quickly, resulting in injuries to the child in the vehicle.

⚠ WARNING

Seat Belt Use

Do not use one seat belt for two occupants at the same time. This will eliminate any safety benefit provided by the seat belt to the occupants.

CRS types

There are three main types of the CRS: rear-facing seats, forward-facing seats, and booster seats. They are classified according to the child's age, height and weight.

Rear-facing child seats



A rear-facing child seat provides restraint with the seating surface against the back of the child. The harness system holds the child in place, and in an accident, acts to keep the child positioned in the seat and reduces the stress to the neck and spinal cord.

All children under age one must always ride in a rear-facing infant child restraint.

Convertible and 3-in-1 child seats typically have higher height and weight limits for the rear-facing position, allowing you to keep your child rear-facing for a longer period of time.

Continue to use a rear-facing child seat for as long as your child will fit within the height and weight limits

allowed by the child seat manufacturer. It's the best way to keep them safe. Once your child has outgrown the rear-facing child restraint, your child is ready for a forward-facing child restraint with a harness.

Forward-facing child restraints



A forward-facing child seat provides restraint for the child's body with a harness. Keep children in a forward-facing child seat with a harness until they reach the top height or weight limit allowed by your child restraint's manufacturer.

Once your child outgrows the forward-facing child restraint, your child is ready for a booster seat.

Booster seats

A booster seat is a restraint designed to improve the fit of the vehicle's seat belt system. A booster seat positions the seat belt so that it fits properly over the lap of your child.

Keep your child in a booster seat until they are big enough to sit in

the seat without a booster and still have the seat belt fit properly. For a seat belt to fit properly, the lap belt must lie snugly across the upper thighs, not the stomach. The shoulder belt should lie snug across the shoulder and chest and not across the neck or face. Children under age 13 must always ride in the rear seats and must always be properly restrained to minimize the risk of injury.

Installing a CRS

After selecting a proper child seat for your child, check to make sure it fits properly in your vehicle.

Follow the instructions provided by the manufacturer when installing the child seat. Note these general steps when installing the seat to your vehicle:

- **Properly secure the child restraint to the vehicle.** All child restraints must be secured to the vehicle with the lap part of a lap/shoulder belt or with the LATCH system.
- **Make sure the child restraint is firmly secured.** After installing a child restraint to the vehicle, push and pull the seat forward and from side-to-side to verify that it is securely attached to the seat. A child restraint secured with a seat belt should be installed as firmly as possible. However, some side-to-side movement can be expected.

- **Secure the child in the child restraint.** Make sure the child is properly strapped in the child restraint according to the manufacturer instructions.

Lower Anchors and Tether for Children (LATCH) system

The LATCH system holds a child restraint during driving and in an accident. This system is designed to make installation of the child restraint easier and reduce the possibility of improperly installing your child restraint. The LATCH system uses anchors in the vehicle and attachments on the child restraint. The LATCH system eliminates the need to use seat belts to secure the child restraint to the rear seats.

Lower anchors are metal bars built into the vehicle. There are two lower anchors for each LATCH seating position that will accommodate a child restraint with lower attachments.

To use the LATCH system in your vehicle, you must have a child restraint with LATCH attachments.

The child seat manufacturer will provide you with instructions on how to use the child seat with its attachments for the LATCH lower anchors.



LATCH anchors have been provided in the left and right outboard rear seating positions. Their locations are shown in the illustration. There are no LATCH anchors provided for the center rear seating position.

⚠ WARNING

LATCH Lower Anchors

Never attempt to attach a LATCH equipped seat in the center seating position. LATCH lower anchors are only to be used in the left and right rear outboard seating positions. You may damage the anchors or the anchors may fail and break in a collision if the seat is in the center seating position.

The lower anchor position indicator symbols are located on the left and right rear seatbacks to identify the position of the lower anchors in your vehicle (see arrows in illustration).

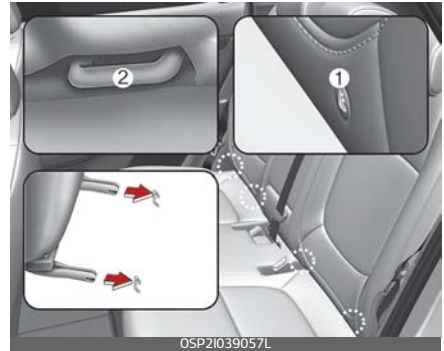

- 1. Lower Anchor position indicator
- 2. Lower Anchor

The LATCH anchors are located between the seatback and the seat cushion of the rear seat left and right outboard seating positions.

To use the lower anchor, push the upper portion of the lower anchor cover.

Securing a child restraint with the LATCH anchors system

To install a LATCH-compatible child restraint in either of the rear out-board seating positions:

1. Move the seat belt buckle away from the lower anchors. Otherwise, the webbing or buckle can be damaged by the latch anchor, which can make them become unusable or unsafe.
2. Move any other objects away from the anchors that could prevent a secure connection between the child restraint and the lower anchors.
3. Place the child restraint on the vehicle seat, then attach the seat to the lower anchors according to the instructions provided by the child restraint manufacturer.
4. Follow the child restraint instructions for properly adjusting and tightening the lower attachments on the child restraint to the lower anchors.

⚠ WARNING

Take the following precautions when using the LATCH system:

- Read and follow all installation instructions provided with your Child Restraint System.
- To prevent the child from reaching and taking hold of the unused seat belts, buckle all unused rear seat belts before the child is placed into the vehicle. Lock each

unused seatbelt following the instructions in the "automatic locking mode" subsection, and place the webbing behind the child seat or against an unused seat-back. Children can be strangled if a shoulder belt becomes wrapped around their neck and the seat belt tightens.

- NEVER attach more than one child restraint to a single anchor. This could cause the anchor or attachment to come loose or break.
- Always have the LATCH system inspected by your authorized Kia dealer after an accident. An accident can damage the LATCH system and may not properly secure the child restraint.

*** NOTICE**

The recommended maximum weight for the LATCH system is 65 lbs. (30 kg). When selecting a proper child restraint, consider that the maximum total weight of the child plus the child restraint should be less than 65 lbs. (30 kg).

As a guide, the MAX child restraint weight should be determined by the following calculation:

Child Restraint Weight = 65 - (child's total weight in lbs.)

Securing a child restraint seat with "Tether Anchor" system



First secure the child restraint with the LATCH lower anchors or the seat belt. If the child restraint manufacturer recommends that the top tether strap be attached, attach and tighten the top tether strap to the top tether strap anchor.

Child restraint hook holders are located on the shelf behind the rear seats.

⚠ WARNING

Take the following precautions when installing the tether strap:

- Read and follow all installation instructions provided with your Child Restraint System.
- NEVER attach more than one child restraint to a single tether anchor. This could cause the anchor or attachment to come loose or break.
- Do not attach the tether strap to anything other than the correct

tether anchor. It may not work properly if attached to something else.

- Do not use the tether anchors for adult seat belts or harnesses, or for attaching other items or equipment to the vehicle.
- Always fasten the seat belts behind the child restraint seat when they are not used to secure the child seat. Failure to do so may result in child strangulation.

To install the tether anchor:

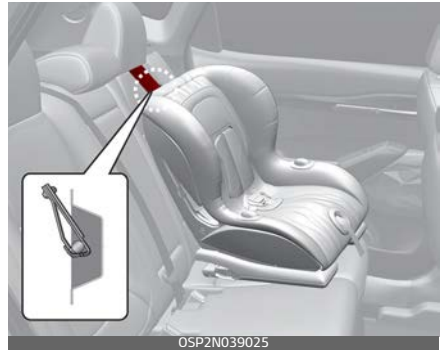

1. Route the child restraint tether strap over the child restraint seatback. Route the tether strap under the head restraint and between the head restraint posts, or route the tether strap over the top of the vehicle seatback. Make sure the strap is not twisted.
2. Connect the tether strap hook to the tether anchor, then tighten the tether strap according to the child seat manufacturer's instructions to firmly secure the child restraint to the seat.

3. Check that the child restraint is securely attached to the seat by pushing and pulling the seat forward and from side-to-side.

Securing a child restraint with a lap/shoulder belt

When not using the LATCH system, all child restraints must be secured to a vehicle rear seat with the lap part of a lap/shoulder belt.

Automatic locking mode



All passenger seat belts move freely under normal conditions and only lock under extreme or emergency conditions (emergency locking mode). So, in order to secure a child restraint, you must manually pull the seat belt all the way out to shift the retractor to the "automatic locking" mode.

The "automatic locking" mode will help prevent the normal movement of the child in the vehicle from causing the seat belt to loosen and compromise the CRS.

To install a CRS on the rear seats, do the following:

1. Place the CRS on a rear seat and route the lap/shoulder belt around or through the child restraint, following the restraint manufacturer's instructions. Be sure the seat belt webbing is not twisted.
2. Fasten the lap/shoulder belt latch into the buckle. Listen for the distinct "click" sound. Position the release button so that it is easy to access in case of an emergency.



3. Pull the shoulder portion of the seat belt all the way out. When the shoulder portion of the seat belt is fully extended, it will shift the retractor to the "automatic locking" (child restraint) mode.



4. Slowly allow the shoulder portion of the seat belt to retract and listen for an audible "clicking" or "ratcheting" sound. This indicates that the retractor is in the "automatic locking" mode. If no distinct sound is heard, repeat steps 3 and 4.



5. Remove as much slack from the belt as possible by pushing down on the CRS while feeding the shoulder belt back into the retractor.
6. Push and pull on the CRS to confirm that the seat belt is holding it firmly in place. If it is not, release the seat belt and repeat steps 2 through 6.
7. Double check that the retractor is in the "automatic locking" mode by attempting to pull more of the seat belt out of the retractor. If you cannot, the retractor is in the "automatic locking" mode.

If your CRS manufacturer instructs or recommends you to use a tether anchor with the lap/shoulder belt, refer to "Securing a child restraint with the LATCH anchors system" on page 3-38 for more information.

* NOTICE

When the seat belt is allowed to retract to its fully stowed position, the retractor will automatically switch from the "automatic locking" mode to the emergency lock mode for normal adult usage.

 **WARNING****Auto lock mode**

Set the retractor to Automatic Lock mode when installing any Child Restraint System. If the retractor is not in the automatic locking mode, the child restraint can move when your vehicle turns or stops suddenly. A child can be seriously injured or killed if the child restraint is not properly anchored in the car.

To remove the child restraint, press the release button on the buckle and then pull the lap/shoulder belt out of the restraint and allow the seat belt to retract fully.

Air bag - advanced Supplemental Restraint System

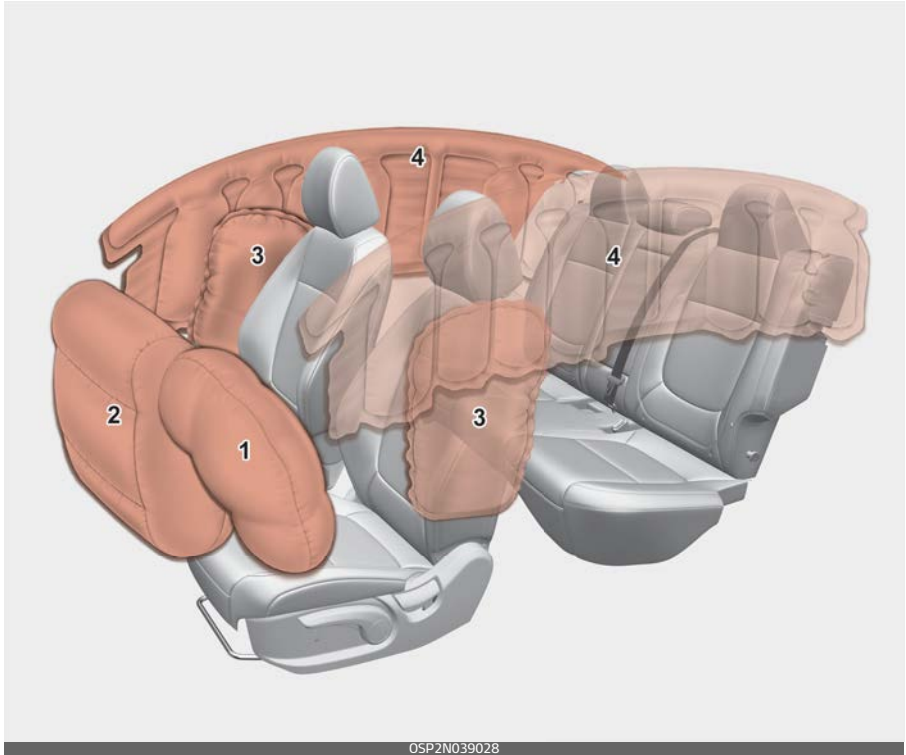

* The actual air bags in the vehicle may differ from the illustration.

1. Driver's front air bag
2. Passenger's front air bag
3. Side air bag
4. Curtain air bag

Even in vehicles with air bags, you and your passengers must always wear the safety belts provided in order to minimize the risk and severity of injury in the event of a collision or rollover.

How does the air bag system operate?

- Air bags are activated (able to inflate if necessary) only when the ENGINE START/STOP button has been turned to the ON position.
- The appropriate air bags inflate instantly in the event of a serious frontal collision or side collision in order to help protect the occupants from serious physical injury.
- There is no single speed at which the air bags will inflate. Generally, air bags are designed to inflate based upon the severity of a collision and its direction, etc. Several factors determine whether the sensors produce an electronic deployment / inflation signal.
- Air bags will not deploy in every crash or collision situations. Air bag deployment depends on a number of factors including vehicle speed, angles of impact, and, the density and stiffness of the vehicles or objects which your vehicle hits in the collision. The determining factors are not limited to those mentioned above.
- The front air bags will completely inflate and deflate in an instant. It is virtually impossible for you to see the air bags inflate during an accident. It is much more likely that you will simply see the deflated air bags hanging out of their storage compartments after the collision.
- In addition to inflating in serious side collisions, side and/or curtain air bags will inflate if the sensing system detects a rollover.
- When a rollover is detected, side and/or curtain airbags will remain inflated longer. This helps provide protection from ejection, especially when used in conjunction with the seat belts.
- In order to help provide protection, the air bags must inflate rapidly. The airbag inflates extremely fast between the occupant and the vehicle structures before the occupant impacts the vehicle structures. This speed of inflation reduces the risk of serious or life-threatening injuries and is thus a necessary part of the air bag design. However, airbag inflation can also cause injuries which can include fascial abrasions, bruises and broken bones. This is because the rapid inflation also causes the airbags to expand with a great deal of force.
- **There are even circumstances under which contact with the steering wheel or passenger air bag can cause fatal injuries, especially if the occupant is positioned excessively close to the steering wheel or passenger air bag.**

⚠ WARNING**Airbag inflation**

Sit as far back as possible from the steering wheel while still maintaining comfortable control of the vehicle. A distance of at least 10 in (25 cm) from your chest to the steering wheel is recommended. Failure to do so can result in airbag inflation injuries to the driver.

Noise and smoke

When inflated, the air bags make a loud noise and leave smoke and powder in the air inside the vehicle. This is normal and is a result of the ignition of the air bag inflator. After the air bag inflates, you may feel substantial discomfort in breathing due to the contact of your chest with both the seat belt and the air bag, as well as from breathing the smoke and powder. **Open your doors and/or windows as soon as possible after impact in order to reduce discomfort and prevent prolonged exposure to the smoke and powder.**

Though smoke and powder are non-toxic, it may cause irritation to the skin (eyes, nose and throat, etc). If this is the case, wash and rinse with cold water immediately and consult a doctor if the symptom persists.

⚠ WARNING**Hot components**

Do not touch the air bag storage area's internal components immediately after airbag inflation. The air bag related parts in the steering wheel, instrument panel and the roof rails above the front and rear doors are very hot. Hot components can result in burn injuries.

⚠ WARNING

Do not install or place any accessories near air bag deployment areas, such as the instrument panel, windows, pillars, and roof rails.

Do not install a child restraint on the front passenger's seat

Never place a rear-facing child restraint in the front passenger's seat.



ODEEV058046NR

If the air bag deploys, it would impact the rear-facing child restraint, causing serious or fatal injury.

In addition, do not place front-facing child restraints in the front passenger's seat. If the front passenger air bag inflates, it could cause serious or fatal injuries to the child.

⚠ WARNING

Air bag deployment

When children are seated in the rear outboard seats of a vehicle equipped with side and/or curtain air bags, install the Child Restraint System as far away from the door side as possible. Inflation of the side and/or curtain air bags could impact the child.

Air bag warning light

The purpose of air bag warning light in your instrument panel is to alert you of a potential problem with your air bag system, which could include your side and/or curtain air bags used for rollover protection.



If the air bag warning light is illuminated for more than 6 seconds after the ENGINE START/STOP button has been turned to the ON position, or if it illuminates during vehicle operation, an SRS component may not be functioning properly and you should have your vehicle checked by an authorized Kia dealer.

If any of the following conditions occur, this indicates a malfunction in the air bag system. Have an authorized Kia dealer inspect the air bag system as soon as possible.

- The light does not turn on briefly when you turn the ENGINE START/STOP button to the ON position.
- The light stays on after illuminating for approximately 6 seconds.
- The light comes on while the vehicle is in motion.
- The light blinks when the ENGINE START/STOP button to the ON position.

Supplemental Restraint System (SRS) components and functions

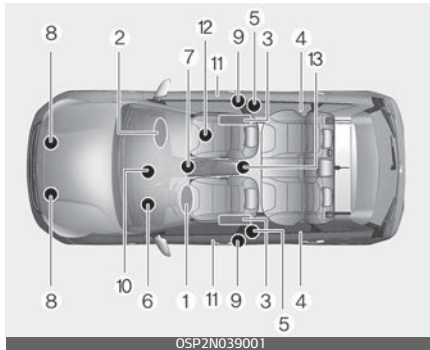

* The actual position of SRS components may differ from the illustration.

The SRS consists of the following components:

1. Driver's front air bag module
2. Passenger's front air bag module
3. Side air bag modules
4. Curtain air bag modules
5. Retractor pre-tensioner assemblies
6. Air bag warning light
7. SRS control module (SRSCM)/ rollover sensor
8. Front impact sensor
9. Side impact sensors
10. Passenger's front air bag ON/OFF indicator*
11. Side pressure sensors
12. Occupant detection system (Front passenger's seat only)
13. Front passenger's seat belt buckle sensor

*: if equipped

Driver's front air bag (1)



The front air bag modules are located both in the center of the steering wheel and in the front passenger's panel above the glove box. When the SRSCM detects a sufficiently severe impact to the front of the vehicle, it will automatically deploy the front air bags.

Driver's front air bag (2)



Upon deployment, tear seams molded directly into the pad covers will separate under pressure from the expansion of the air bags. Further opening of the covers then allows full inflation of the air bags.

Driver's front air bag (3)



A fully inflated airbag (with a properly fastened seat belt) slows the forward motion of the driver or passenger, reducing the risk of head and chest injury.

After complete inflation, the air bag immediately starts deflating, enabling the driver to maintain forward visibility and the ability to steer or operate other controls.

Passenger's front air bag



⚠ WARNING

Air bag obstructions

Do not install or place any accessories on the steering wheel, instrument panel, or on the front passenger's panel above the glove box in a vehicle. Such objects may become dangerous projectiles if the air bag deploys.

⚠ WARNING

Flying objects

Do not place any objects (an umbrella, bag, etc.) between the front door and the front seat. Such objects may become dangerous projectiles if the side airbag inflates.

- If an air bag deploys, there may be a loud noise followed by a fine dust released in the vehicle. These conditions are normal and are not hazardous – the air bags are packed in this fine powder. The dust generated during air bag deployment may cause skin or eye irritation as well as aggravate asthma for some persons. Always wash all exposed skin areas thoroughly with cold water and a mild soap after an accident in which the air bags were deployed.

- The SRS can function only when the ENGINE START/STOP button is in the ON position. The SRS is not working properly if any of the following situations occur:
 - the SRS airbag warning light does not illuminate
 - the SRS airbag warning light remains on continuously after illuminating for about 6 seconds when the ENGINE START/STOP button is turned to the ON position or after the vehicle is in ready mode
 - the SRS airbag warning light comes on while driving
 If this occurs, have your vehicle immediately inspected by an authorized Kia dealer.

*** NOTICE**

Before you replace a fuse or disconnect a battery terminal, change the ENGINE START/STOP button to the OFF position. Never remove or replace the air bag related fuse(s) when the ENGINE START/STOP button is ON position. Failure to heed this warning will cause the SRS air bag warning light to illuminate.

Occupant Detection System (ODS)

Your vehicle is equipped with an Occupant Detection System (ODS) in the front passenger's seat.





The ODS is designed to detect the presence of a properly-seated front passenger and determine if the passenger's front air bag should be enabled (may inflate) or not. Only the front passenger front air bag is controlled by the ODS.

Do not put anything in front of the passenger air bag "⊗" indicator.

Main components of the ODS

- A detection device is located within the front passenger seat cushion.
- An electronic system determines whether the passenger air bag systems should be activated or deactivated.

- An indicator light located on the overhead console which illuminates the words PASSENGER AIR BAG "" indicates the front passenger air bag system is deactivated.
- The overhead console air bag warning light is interconnected with the ODS.

If the front passenger seat is occupied by a person that the system determines to be of appropriate size, and he/she sits properly (sitting upright with the seatback in an upright position, centered on the seat cushion with their seat belt on, legs comfortably extended and their feet on the floor), the PASSENGER AIR BAG "" indicator will turn off and the front passenger's air bag will be able to inflate, if necessary, in frontal crashes.

You will find the PASSENGER AIR BAG "" indicator on the overhead console. This system detects the conditions 1~4 in the following table and activates or deactivates the front passenger air bag based on these conditions.

Always be sure that you and all vehicle occupants are seated and restrained properly (sitting upright with the seat in an upright position, centered on the seat cushion, with the person's legs comfortably extended, feet on the floor, and wearing the safety belt properly) for the most effective protection by the air bag and the safety belt.

The ODS may not function properly if the passenger takes actions which can defeat the detection system.

These include:

- Failing to sit in an upright position.
- Leaning against the door or center console.
- Sitting towards the sides or the front of the seat.
- Putting legs on the dashboard or resting them on other locations which reduce the passenger weight on the front seat.
- Improperly wearing the safety belt.
- Reclining the seatback.

Conditions and operation of the front passenger ODS

Condition detected by the occupant classification system	Indicator/Warning light		Devices
	"PASSENGER AIR BAG OFF" indicator light	SRS warning light	Front passenger air bag
1. Adult* ¹	Off	Off	Activated
2. Child Restraint System (CRS) with child under 12 months old* ² * ³ * ⁴	On	Off	Deactivated
3. Unoccupied	On	Off	Deactivated
4. Malfunction in the system	Off	On	Activated

- *1. The system judges a person of adult size as an adult. When a smaller adult sits in the front passenger seat, the system may recognize him/her as a child depending on his/her physique and posture.
- *2. Do not allow children to ride in the front passenger seat. When a larger child who has outgrown a CRS sits in the front passenger seat, the system may recognize him/her as an adult depending upon his/her physique or sitting position.
- *3. Never install a CRS on the front passenger seat.
- *4. The PASSENGER AIR BAG  indicator may turn on or off when a child above 12 months to 12 years old (with or without a CRS) sits in the front passenger seat. This is a normal condition.

⚠ WARNING

- Do not install a child restraint seat in the passenger seat when the seat is heavily soaked with any type of liquid.
- Do not alter or remodel the Occupant Detection System (ODS). This may damage the system and prevent its proper function in a collision.

*** NOTICE**

- Do not use car seat cushions that cover up the surface of the seat and aftermarket manufactured passenger seat heaters.
- After conducting car interior cleaning using steam or detergent, the seat should be dried properly. Afterward, check for normal operation of the PASSENGER AIR BAG "OFF" and air bag warning lights.
- Any service related to the passenger seat and the ODS must be

done at an authorized Kia dealership.

- After the passenger seat has been removed or installed for repair purposes, check for normal operation of the PASSENGER AIR BAG "⊗₂" and air bag warning lights with a person seated or not seated in the passenger seat.

⚠ WARNING

When the PASSENGER AIR BAG "⊗₂" symbol is illuminated, the passenger air bag system will not operate. The passenger air bag system will operate when necessary if the symbol is not illuminated.

*** NOTICE**

Do not modify or replace the front passenger seat. Don't place anything on or attach anything such as a blanket, front seat cover or aftermarket seat heater to the front passenger seat. This can adversely affect the Occupant Detection System.

⚠ WARNING

Occupant Detection System

Riding in an improper position adversely affects the Occupant Detection System and may result in the deactivation of the front passenger airbag. It is important for the driver to instruct the passenger as to the proper seating instructions as contained in this manual.

- Do not place a heavy load in the front passenger seatback pocket or on the front passenger seat.



- Do not place feet on the front passenger seatback.



Safety features of your vehicle

- Never sit with hips shifted towards the front of the seat.



- Never excessively recline the front passenger seatback.



- Never place feet on the dashboard.



Air bag - advanced Supplemental Restraint System

- Never lean on the door or center console.
- Never sit on one side of the front passenger seat.



- Do not use car seat accessories such as thick blankets and cushions which cover up the car seat surface.
- Do not sit on the passenger seat wearing heavily padded clothes such as ski wear and hip protector.



Safety features of your vehicle

- Do not place electronic devices such as laptops, DVD player, or conductive materials such as water bottles on the passenger seat.
- Do not use electronic devices such as laptops and satellite radios which use inverter chargers.



- **Wet passenger seat:**
Do not spill liquid in the passenger seat. Spilled liquid on the passenger seat may cause the air bag warning light to illuminate or malfunction. If any liquid is spilled, make sure the seat has been completely dried before driving the vehicle.

Air bag – advanced Supplemental Restraint System

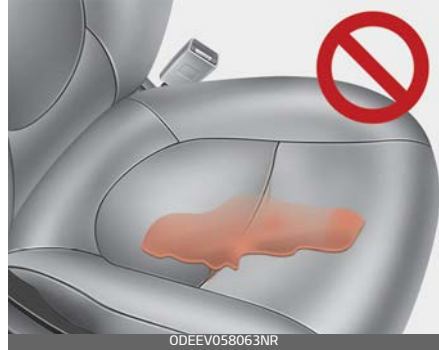

Proper position





When an adult is seated in the front passenger seat, if the **PASSENGER AIR BAG** "⊗" indicator is on, change the **ENGINE START/STOP** button to the **OFF** position and ask the passenger to sit properly (sitting upright with the seatback in an upright position, centered on the seat cushion with their seat belt on, legs comfortably extended and their feet on the floor). Restart the vehicle and have the person remain in that position. This will allow the sys-

tem to detect the person and to enable the passenger air bag.

If the PASSENGER AIR BAG  indicator is still on, ask the passenger to move to the rear seat.

WARNING

PASSENGER AIR BAG light

Do not allow an adult passenger to ride in the front seat when the PASSENGER AIR BAG  indicator is illuminated, because the air bag will not deploy in the event of a crash. The driver must instruct the passenger to reposition himself in the seat. Failure to properly position yourself may lead to air bag deactivation resulting in air bag non-deployment in a collision. If the PASSENGER AIR BAG  indicator remains illuminated after the passenger repositions themselves properly and the car is restarted, it is recommended that passenger move to the rear seat because the passenger's front air bag will not deploy.

* NOTICE

The PASSENGER AIR BAG  indicator illuminates for about 4 seconds after the ENGINE START/STOP button is turned to the ON position after the vehicle is started. If the

front passenger seat is occupied, the occupant detection sensor will then classify the front passenger after several more seconds.

- Even though your vehicle is equipped with the Occupant Detection System, never install a Child Restraint System in the front passenger's seat. A deploying air bag can forcefully strike a child resulting in serious injuries or death.

Any child age 13 and under should ride in the rear seat. Children too large for child restraints should use the available lap/shoulder belts. No matter what type of crash, children of all ages are safer when restrained in the rear seat.

If the ODS is not working properly, the Supplemental Restraint System (SRS) air bag warning light on the instrument panel will illuminate because the passenger's front air bag is connected with the ODS. If there is a malfunction of the ODS the PASSENGER AIRBAG  indicator will not illuminate. In this case, the passenger's front airbag will inflate in frontal impact crashes even if there is no occupant in the front passenger seat.

Driver's and passenger's front air bag

Your vehicle is equipped with an advanced supplemental restraint (air bag) system and lap/shoulder belts at both the driver and passenger seating position.

Driver's front air bag



Passenger's front air bag

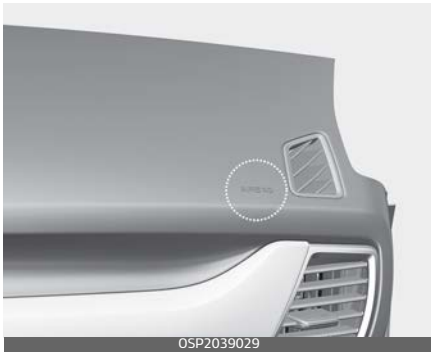

The indication of the system's presence are the letters "AIR BAG" located on the air bag pad cover on the steering wheel and the passenger's side front panel pad above the glove box.

The Supplemental Restraint System (SRS) consists of air bags installed under the pad covers in the center of the steering wheel and the passenger's side front panel above the glove box.

The purpose of the SRS is to provide the vehicle's driver and/or the front passenger with additional protection than that offered by the seat belt system alone in case of a frontal impact of sufficient severity. The SRS uses sensors to gather information about the driver's and front passenger's seat belt usage and impact severity.

The seat belt buckle sensor determines if the front passenger's seat belt is fastened.

These sensors provide the ability to control the SRS deployment based on whether or not the seat belts are fastened, and how severe the impact is.

The advanced SRS offers the ability to control the air bag inflation with two levels. A first stage level is provided for moderate-severity impacts. A second stage level is provided for more severe impacts.

According to the impact severity and seat belt usage, the SRS Control Module (SRSCM) controls the air bag inflation. Failure to properly wear

seat belts can increase the risk or severity of injury in an accident.

Additionally, your vehicle is equipped with an Occupant Detection System (ODS) in the front passenger's seat. The ODS detects the presence of a passenger in the front passenger's seat and will turn off the front passenger's air bag under certain conditions. For more detail, see "Occupant Detection System (ODS)" on page 3-49.

⚠ WARNING

Modification to the seat structure can cause the air bag to deploy at a different level than should be provided.

Manufacturers are required by government regulations to provide a contact point concerning modifications to the vehicle for persons with disabilities, which modifications may affect the vehicle's advanced air bag system. That contact is Kia's toll-free Customer Assistance center at 1-800-333-4Kia. However, Kia does not endorse nor will it support any changes to any part or structure of the vehicle that could affect the advanced air bag system, including the ODS.

⚠ WARNING

Replacement/modifications

The front passenger seat, dashboard or door should not be replaced except by an authorized Kia dealer using original Kia parts designed for this vehicle and model. Any other such replacement or modification could adversely affect the operation of the Occupant Detection System and your advanced air bags.

Advanced air bags are combined with pre-tensioner seat belts to help provide enhanced occupant protection in frontal crashes. Front air bags are not intended to deploy in collisions in which sufficient protection can be provided by the seat belt.

*** NOTICE**

Air bags can only be used once – have an authorized Kia dealer replace the air bag immediately after deployment.

Front air bags are not intended to deploy in side-impact, rear-impact or rollover crashes. However, when frontal deployment threshold is satisfied at side-impact, front air bags may deploy. In addition, front air bags will not deploy in frontal crashes below the deployment threshold.

⚠ WARNING

SRS Wiring

Do not tamper with or disconnect SRS wiring or other components of the SRS system. Doing so could result in injury, due to accidental deployment of the air bags or by rendering the SRS inoperative.

⚠ WARNING

No attaching objects

No objects (such as crash pad cover, cellular phone holder, cup holder, perfume or stickers) should be placed over or near the air bag modules on the steering wheel, instrument panel, windshield glass, and the front passenger's panel above the glove box. Such objects could cause harm if the vehicle is in a crash severe enough to cause the air bags to deploy.

Do not place any objects over the air bag or between the air bag and yourself.

Additionally, never place or insert any object into any small opening near side airbag labels attached to the vehicle seats.

When the air bag deploys, the object may affect the deployment and result in unexpected accident or bodily harm.

Side air bag

Your vehicle is equipped with a side air bag in each front seat.

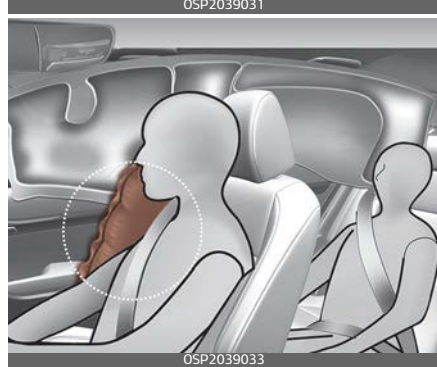

* The actual air bags in the vehicle may differ from the illustration.

The purpose of the air bag is to provide the vehicle's driver and/or the front passenger with additional protection than that offered by the seat belt alone.

- The side air bags are designed to deploy during certain side-impact collisions, depending on the crash severity of impact.

- The side air bags may deploy on the side of the impact or on both sides.
- The side and/or curtain air bags on both sides of the vehicle will deploy if a rollover or possible rollover is detected.
- The side air bags are not designed to deploy in all side impact or roll-over situations.

⚠ WARNING

Unexpected deployment

Avoid impact to the side impact air-bag sensor when the ENGINE START/STOP button is ON to prevent unexpected deployment of the side air bag.

- The side air bag is supplemental to the driver's and the passenger's seat belt systems and is not a substitute for them. Therefore your seat belts must be worn at all times while the vehicle is in operation.
- For best protection from the side air bag system and to avoid being injured by the deploying side air bag, both front seat occupants should sit in an upright position with the seat belt properly fastened. The driver's hands should be placed on the steering wheel at the 9:00 and 3:00 positions. The passenger's arms and hands should be placed on their laps.

⚠ WARNING

Deployment

Do not install any accessories including seat covers, on the side or near the side air bag as this may affect the deployment of the side air bags.

- If the seat or seat cover is damaged, have the vehicle checked and repaired by an authorized Kia dealer. Inform the dealer that your vehicle is equipped with side air bags and an Occupant Detection System (ODS).

⚠ WARNING

Flying objects

Do not place any objects (an umbrella, bag, etc.) between the front door and the front seat. Such objects may become dangerous projectiles if the side airbag inflates.

⚠ WARNING

No attaching objects

- Do not place any objects over the air bag or between the air bag and yourself. Also, do not attach any objects around the area the air bag inflates such as the door, side door glass, front and rear pillar.
- Do not put any objects between the side airbag label and seat cushion. It could cause harm if the vehicle is in a crash severe enough to cause the air bags to deploy.
- Never place or insert any object into any small opening near side airbag labels attached to the vehicle seats. When the air bag deploys, the object may affect the deployment and result in unexpected accident or bodily harm.
- Do not install any accessories on the side or near the side air bags.

Curtain air bag

Curtain air bags are located along both sides of the roof rails above the front and rear doors.

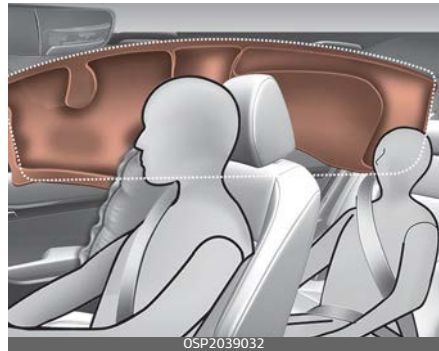

* The actual air bags in the vehicle may differ from the illustration.

They are designed to help protect occupants in certain side impacts and to help prevent them from ejecting out of the vehicle as a result of a rollover, especially when the seatbelts are also in use.

- The curtain air bags are designed to deploy during certain side impact collisions, depending on the severity of impact. However, when side deployment threshold is satisfied at front-impact, side air bags may deploy.
- The curtain air bags may deploy on the side of the impact or on both sides.
- Also, the curtain air bags on both sides of the vehicle will deploy in certain rollover situations.
- The curtain air bags are not designed to deploy in all side impact or rollover situations.

Do not allow the passengers to lean their heads or bodies against the doors, put their arms on the doors, stretch their arms out of the window or place objects between the doors and passengers when they are seated on seats equipped with side impact and/or curtain air bags.

*** NOTICE**

Never try to open or repair any components of the side and curtain air bag system. This should only be done by an authorized Kia dealer.

⚠ WARNING

No attaching objects

- Do not place any objects over the air bag. Also, do not attach any

objects around the area the air bag inflates such as the door, side door glass, front and rear pillar, roof side rail.

- Do not hang hard, breakable, or heavy objects on the coat hooks for safety reasons.

Air bag collision sensors

The air bag collision sensors are located in the following positions.



* The actual shape and position of sensors may differ from the illustration.

- 1. Supplemental Restraint System (SRS) control module/rollover sensor
- 2. Front impact sensor
- 3. Side pressure sensors
- 4. Side impact sensor

⚠ WARNING**Air bag sensors**

- Do not hit or allow any objects to impact the locations where air bags or sensors are installed. This may cause unexpected air bag deployment, which could result in serious personal injury or death.
- If the installation location or angle of the sensors is altered in any way, the air bags may deploy when they should not or they may not deploy when they should. Therefore, do not try to perform maintenance on or around the air bag sensors. Have the vehicle checked and repaired by an authorized Kia dealer.
- Do not arbitrarily touch the front impact sensor. When the angle of the sensor is changed, the air bag system may malfunction.

Problems may arise if the sensor installation angles are changed due to the deformation of the front bumper, front end module, body or front doors where side collision sensors are installed. Have the vehicle checked and repaired by an authorized Kia dealer.

Installing bumper guards (or side step or running board) or replacing a bumper (or front door module) with non-genuine parts may adversely affect your vehicle's collision and air bag deployment performance.

Why didn't my air bag go off in a collision? (Inflation and non-inflation conditions of the air bag)

There are many types of accidents in which the air bag would not be expected to provide additional protection.

These include rear impacts, second or third collisions in multiple impact accidents, as well as low speed impacts.

Air bag inflation conditions**Front air bags**

Front air bags are designed to inflate in a frontal collision depending on several factors, including the severity of impact of the front collision.

Side and/or curtain air bags

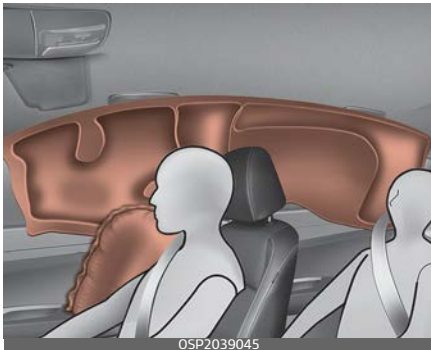

* The actual air bags in the vehicle may differ from the illustration. Side and/or curtain air bags are designed to inflate when an impact is detected by side collision sensors depending on several factors, including the severity of impact resulting from a side impact collision.

Also, the side and curtain air bags are designed to inflate when a roll-over is detected by a rollover sensor. Although the front air bags (driver's and front passenger's air bags) are primarily designed to inflate in frontal collisions, they may inflate in other types of collisions if the front impact sensors detect a sufficient frontal force in another type of impact.

Similarly, although side and curtain air bags are designed to inflate in certain side impact collisions, they may inflate in other types of collisions where a side force is detected by the sensors. For instance, side air bag and/or curtain air bags may inflate if rollover sensors indicate the possibility of a rollover occurring (even if none actually occurs) or in other situations, including when the vehicle is tilted while being towed. Even if side and/or curtain air bags do not provide impact protection in a rollover, they will deploy to prevent ejection of occupants, especially those who are restrained with seat belts.

If the vehicle chassis is impacted by bumps or objects on unimproved roads, the air bags may deploy. Drive carefully on unimproved roads or on surfaces not designed for vehicle traffic to prevent unintended air bag deployment.

Air bag non-inflation conditions

- Air bags may not deploy in certain low-speed collisions where the air bag would not add any benefit beyond the protection already offered by the seat belts.



- Air bags are not designed to inflate in rear collisions, because occupants are moved backward by the force of the impact. In this case, inflated air bags would not be able to provide any additional benefit.



- Front airbags may not inflate in side impact collisions, because passengers move in the direction of the collision. Thus, in side impacts, frontal airbag deployment would not provide additional occupant protection.



- In an angled collision, the force of impact may direct the occupants in a direction where the air bags would not be able to provide any additional benefit, and thus the sensors may not deploy any air bags.



Safety features of your vehicle

- Just before impact, drivers often brake heavily. Such heavy braking lowers the front portion of the vehicle causing it to "ride" under a vehicle with a higher ground clearance. Air bags may not inflate in this "under-ride" situation because deceleration forces that are detected by sensors may be significantly reduced by such "under-ride" collisions.

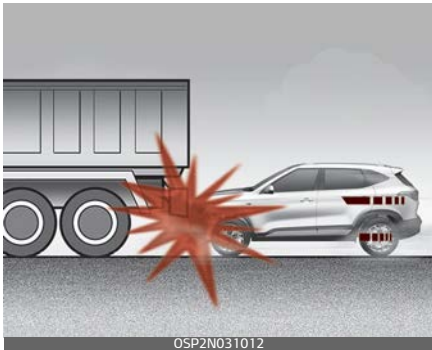

- Front air bags may not inflate in all rollover accidents when the SRS Control Module (SRSCM) indicates that the front air bag deployment would not provide additional occupant protection.

Air bag – advanced Supplemental Restraint System

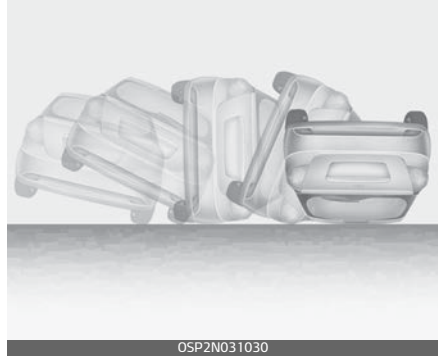

- Airbags may not inflate if the vehicle collides with an object such as a utility pole or tree. This is because the point of impact is concentrated in one area and the full force of the impact is not delivered to the sensors.



Supplemental Restraint System (SRS) care

The Supplemental Restraint System (SRS) is virtually maintenance-free and so there are no parts you can safely service by yourself.

If the SRS air bag warning light does not illuminate, or continuously remains on, have your vehicle immediately inspected by an authorized Kia dealer.

Any work on the SRS, such as removing, installing, repairing, or any work on the steering wheel, the front passenger's panel, front seats and roof rails must be performed by an authorized Kia dealer. Improper handling of the SRS may result in serious personal injury.

For cleaning the air bag pad covers, use only a soft, dry cloth or one which has been moistened with plain water. Solvents or cleaners could adversely affect the air bag covers and proper deployment of the system.

If components of the air bag system must be discarded, or if the vehicle must be scrapped, certain safety precautions must be observed. An authorized Kia dealer knows these precautions and can give you the necessary information. Failure to follow these precautions and proce-

dures could increase the risk of bodily injury.

WARNING

Tampering with SRS

Do not tamper with or disconnect SRS wiring or other components of the SRS system. Doing so could result in the accidental inflation of the air bag or render the SRS inoperative.

WARNING

Towing Vehicle

Always have the ignition off when your vehicle is being towed. The side air bags may inflate if the vehicle is tilted such as when being towed because of the rollover sensors in the vehicle.

Adding equipment to or modifying your air bag-equipped vehicle

If you modify your vehicle by changing your vehicle's frame, bumper system, front end or side sheet metal or ride height, this may affect the operation of your vehicle's air bag system.

Air bag warning label

Air bag warning labels, some required by the U.S. National Highway Traffic Safety Administration (NHTSA), are attached to the sun visor to alert the driver and passengers of potential risks of the air bag system.



Keys	4-7
Remote keyless entry	4-8
• Battery replacement	4-10
• This device complies with Part 15 of the FCC rules.	4-11
Smart key	4-12
• Smart key functions	4-12
Folding key immobilizer system (if equipped)	4-15
Smart key immobilizer system	4-16
Theft-alarm system	4-17
• Armed stage.....	4-17
• Theft-alarm stage	4-18
• Disarmed stage.....	4-19
Door locks	4-20
• Operating door locks from outside the vehicle	4-20
• Operating door locks from inside the vehicle	4-21
• Door lock/unlock features.....	4-23
• In case of an emergency	4-23
• Child-protector rear door lock	4-24
• Safe Exit Warning (SEW)	4-24
• Rear Occupant Alert (ROA) system.....	4-26
Liftgate	4-27
• Opening the liftgate	4-27
• Closing the liftgate	4-28
• Opening the liftgate in emergency	4-28
Windows	4-30
• Window opening and closing	4-32
• Power window lock button	4-34
Hood	4-35

4 Features of your vehicle

• Opening the hood	4-35
• Hood open warning	4-36
• Closing the hood	4-36
Fuel filler door	4-37
• Opening the fuel filler door	4-37
• Closing the fuel filler door	4-38
Sunroof	4-41
• Sunshade.....	4-42
• Tilt open/close.....	4-42
• Slide open/close	4-43
• Automatic reversal	4-43
• Resetting the sunroof	4-44
• Sunroof open warning	4-45
Steering wheel.....	4-46
• Electric Power Steering (EPS)	4-46
• Tilt & telescopic steering wheel	4-47
• Heated steering wheel	4-48
• Horn	4-49
Mirrors	4-49
• Inside rearview mirror	4-49
• Outside rearview mirror	4-51
Instrument cluster	4-53
• Instrument cluster control.....	4-54
• Gauges.....	4-54
• Transmission shift indicator	4-57
LCD display	4-58
• LCD Display Control	4-58
• LCD Display Modes	4-59
LCD displays	4-68

• Trip information (trip computer)	4-68
• Service Mode	4-70
• Driving info display	4-71
• LCD display messages	4-72
Warning and indicator lights	4-76
• Warning lights	4-76
• Indicator lights	4-82
Head-Up Display (HUD).....	4-86
• Head-Up Display Information.....	4-88
• Head up Display Setting	4-88
Rear View Monitor (RVM).....	4-89
• Rear View Monitor – Top view	4-89
Reverse Parking Distance Warning (PDW)	4-90
Forward/Reverse Parking Distance Warning (PDW).....	4-93
Lighting.....	4-98
• Battery saver function	4-98
• Daytime Running Light (DRL).....	4-99
• Lighting control.....	4-99
• Operating high beam	4-100
• Operating turn signals and lane change signals	4-101
• Operating front fog light	4-102
• High Beam Assist (HBA)	4-102
Wipers and washers	4-106
• Auto control.....	4-107
• Operating windshield washers	4-108
• Operating rear window wiper and washer switch.....	4-109
• Auto rear wiper.....	4-109
Interior lights	4-110

4 Features of your vehicle

- Automatic turn off function 4-110
- Map lamp 4-110
- Room lamp 4-111
- Luggage room lamp 4-111
- Vanity mirror lamp 4-112
- Glove box lamp 4-112
- Welcome system..... 4-113**
- Climate control system..... 4-113**
- System operation 4-113
- Climate control air filter 4-115
- Checking the amount of air conditioner refrigerant and compressor lubricant 4-116
- Air conditioning refrigerant label 4-117
- Manual climate control system 4-118**
- Heating and air conditioning 4-119
- Automatic climate control system 4-124**
- Heating and air conditioning automatically 4-125
- Heating and air conditioning manually 4-127
- Windshield defrosting and defogging..... 4-132**
- Defogging inside windshield with manual climate control system 4-132
- Defrosting outside windshield with manual climate control system 4-133
- Defogging inside windshield with the automatic climate control 4-133
- Defrosting outside windshield with automatic climate control 4-134
- Defroster 4-134
- Front glass heater 4-135

• Defogging logic	4-136
• Auto Defogging System (ADS) (only for automatic climate control system).....	4-137
Storage compartment	4-138
• Center console storage	4-138
• Sliding armrest.....	4-139
• Glove box.....	4-139
• Escort light	4-139
• Luggage net holder	4-140
• Increase cargo space.....	4-140
Interior features	4-141
• Ambient light and Sound mood lamp.....	4-141
• Cigarette lighter	4-142
• Ashtray	4-142
• Cup holder.....	4-143
• Seat warmer	4-144
• Air ventilation seat.....	4-145
• Sun visor	4-146
• USB charger.....	4-146
• Power outlet	4-148
• Wireless smart phone charging system.....	4-149
• Coat hook.....	4-152
• Floor mat anchor(s)	4-153
• Cargo area cover	4-153
Exterior features	4-154
• Roof rack.....	4-154
Audio system.....	4-156
• Antenna.....	4-156
• USB port.....	4-156

4 Features of your vehicle

- How vehicle radio works..... 4-156
- **Declaration of Conformity**..... **4-159**
- FCC 4-159

FEATURES OF YOUR VEHICLE

Keys

Record your key number



The key code number is stamped on the key code tag attached to the key set. Should you lose your keys, this number will enable an authorized Kia dealer to duplicate the keys easily. Remove the key code tag and store it in a safe place. Also, record the key code number and keep it in a safe and handy place, but not in the vehicle.

⚠ WARNING

Aftermarket keys

Use only Kia original parts for the ignition key in your vehicle. If an aftermarket key is used, the ignition switch may not return to ON after START. If this happens, the starter will continue to operate causing possible fire due to excessive current in the wiring.

Key operations

Folding key

To unfold the key, press the release button then the key will unfold automatically.

Folding key



To fold the key, fold the key manually while pressing the release button.

⚠ CAUTION

Key button operation

Do not fold the key without pressing the release button. This may damage the key. Controlling fan speed

Smart key

To remove the mechanical key, press and hold the release button (1) and remove the mechanical key (2).

Smart key



To reinstall the mechanical key, put the key into the hole and push it until a click sound is heard.

⚠ WARNING

Ignition key

Never leave the keys in your vehicle with unsupervised children. Leaving children unattended in a vehicle with a manual ignition key or a smart key is dangerous.

Children copy adults and they could place the key in the ignition switch or press the start button. The key would enable children to operate power windows or other controls, or even make the vehicle move, which could result in serious bodily injury or death.

Remote keyless entry

Using the remote keyless entry, you can lock and unlock the doors remotely.

Remote keyless entry system operations

Folding key



Smart key



Lock (1)

All doors are locked if the lock button is pressed. If all doors are closed, the hazard warning lights will blink and the chime will sound once (for

Type B) to indicate that all doors are locked.

Also, if the lock button is pressed once more within 4 seconds, the hazard warning lights will blink and the chime will sound once to confirm that the door is locked.

However, if any door remains open, the hazard warning lights (and/or the chime) will not operate. But if all doors are closed after the lock button is pressed, the hazard warning lights will blink once.

Unlock (2)

The driver's door is unlocked if the unlock button is pressed once. The hazard warning lights will blink twice and the chime will sound twice (for Type B) to indicate that the driver's door is unlocked.

All doors are unlocked if the unlock button is pressed once more within 4 seconds. The hazard warning lights will blink (for smart key, the chime also sounds) twice again to indicate that all doors are unlocked. After pressing this button, the doors will lock automatically unless you open any door within 30 seconds. If you attempt to lock or unlock the door by pressing the door lock/unlock button in any of the following states, the door will not be locked or unlocked.

- When you want to lock or unlock the door in the ACC or ON state.
- When you want to lock a door in a car with one or more doors open.

Depending on the vehicle, the driver can turn off or set the Two Press Unlock setting function.

* NOTICE

If the keyless entry system is inoperative due to exposure to water or liquids, it will not be covered by your manufacturer's vehicle warranty.

Panic alarm (3)

The horn sounds and the hazard warning lights blink for about 30 seconds if this button is pressed for more than 0.5 seconds. To stop the horn and lights, press any button on the transmitter.

Remote start (4, if equipped)

You can start the vehicle using the remote start button (4) of the smart key.

To start the vehicle remotely:

- Lock the doors by pressing the door lock button (1) within 32 ft (10 m) distance from the vehicle.
- Press the remote start button for over 2 seconds within 4 seconds after locking the doors.

Press the remote start button once to turn off the vehicle.

If no further action for operating/driving the vehicle is taken, the vehicle will be turned off 10 minutes after starting the vehicle remotely.

Start-up

You can start the vehicle without inserting the key.

* For more information, refer to "ENGINE START/STOP button (if equipped)" on page 5-13.

Remote keyless entry precautions

The remote keyless entry will not work if any of the following occurs:

- The ignition key is in the ignition switch. (if equipped)
- You exceed the operating distance limit (about 33 feet [10 m]).
- The battery in the remote keyless entry is weak.
- Other vehicles or objects may be blocking the signal.
- The weather is extremely cold.
- The remote keyless entry is close to a radio transmitter such as a radio station or an airport which can interfere with normal operation of the transmitter.

When the remote keyless entry does not work properly, open and close the door with the ignition key. If you have a problem with the remote keyless entry, contact an authorized Kia dealer.

- If the remote keyless entry is in close proximity to your cell phone or smart phone, the signal from the remote keyless entry could be blocked by normal operation of your cell phone or smart phone. This is especially important when

the phone is active such as making calls, receiving calls, text messaging, and/or sending/receiving emails. Avoid placing the remote keyless entry and your cell phone or smart phone in the same pants or jacket pocket and maintain adequate distance between the two devices.

Battery replacement

A battery should last for several years, but if the remote keyless entry is not working properly, try replacing the battery with a new one.



If you are unsure how to use or replace the battery, contact an authorized Kia dealer.

1. Detach mechanical key from your smart key.
2. Pry open the remote keyless entry cover.
3. Replace the smart key cover with a new battery (CR2032). When replacing the battery, make sure the battery position is correct.

4. Install the battery in the reverse order of removal.

The remote keyless entry is designed to give you years of trouble-free use, however it can malfunction if exposed to moisture or static electricity. If you are unsure how to use or replace the battery, contact an authorized Kia dealer.

Using the wrong battery can cause the remote keyless entry to malfunction. Be sure to use the correct battery.



An inappropriately disposed battery can be harmful to the environment and human health.

Dispose the battery according to your local law(s) or regulation.

⚠ CAUTION

Remote keyless entry damage

The remote keyless entry can malfunction if dropped, exposed to moisture, static electricity, heat or direct sunlight.

This device complies with Part 15 of the FCC rules.

Operation is subject to the following two conditions:

1. This device may not cause harmful interference, and
2. This device must accept any interference received, including interference that may cause undesired operation.

*** NOTICE**

Changes or modifications not expressly approved by the party responsible for compliance could void the user's authority to operate the equipment. If the smart key is inoperative due to changes or modifications not expressly approved by the party responsible for compliance, it will not be covered by your manufacturer's vehicle warranty.

Smart key (if equipped)



With a smart key, you can lock or unlock a door and even start the engine without inserting the key.

The functions of buttons on a smart key are similar to the folding key.

Refer to "Remote keyless entry" on page 4-8.

⚠ WARNING

Smart key

Never leave the keys in your vehicle with unsupervised children. Leaving children unattended in a vehicle with the smart key is dangerous even if the ENGINE START/STOP button is not in the ACC or ON position. Children copy adults and they could press the ENGINE START/STOP button. The key would enable children to operate power windows or other controls, or even make the vehicle move, which could result in serious bodily injury or death.

Smart key functions

Carrying the smart key, you may lock and unlock the vehicle doors (and liftgate). Also, you may start the engine.

Locking

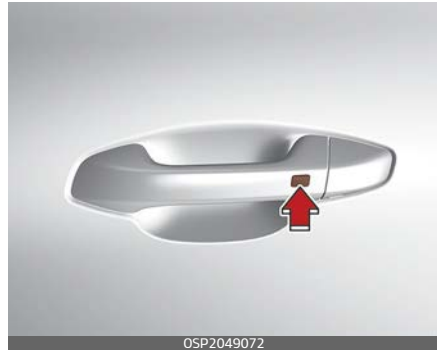

Pressing the button of the front driver side door handles with all doors (and liftgate) closed and any door unlocked, locks all the doors (and liftgate). If all doors (and liftgate) and engine hood are closed, the hazard warning lights will blink once and the chime will sound once to indicate.

The button will only operate when the smart key is within 28~40 in (0.7~1 m) from the driver side door handle. If you want to make sure that a door has locked or not, you should check the door lock button inside the vehicle or pull the driver side door handle.

Even though you press the driver side door handle buttons, the doors will not lock and the chime will sound for 3 seconds if any of following occur:

- The smart key is in the vehicle.
- The ENGINE START/STOP button is in the ACC or ON position.
- Any door except the liftgate is open.

Unlocking

Pressing the button of the front outside door handle, with all doors (and liftgate) closed and locked, unlocks all the doors (and liftgate), if the Two Press Unlock function is deactivated.

The button will only operate when the smart key is within 28~40 in (0.7~1 m) from the outside door handle.

When the Two Press Unlock function is activated:

- If you press the Door Unlock button on the smart key, the driver's door will unlock.
- If you press the Door Unlock button on the smart key within four seconds again, then all the doors will unlock.
- If you press the driver's outside door handle button, the driver's door will unlock.
- If you press the driver's outside door handle button within four seconds again, then all the doors will unlock.

*** NOTICE**

You can activate or deactivate the Two Press Unlock function. Refer to "User Settings mode" on page 4-61.

*** NOTICE**

Loss of the smart key

A maximum of 2 smart keys can be registered to a single vehicle.

If you happen to lose your smart key, you will not be able to start the vehicle. You should immediately take the vehicle and remaining key to your authorized Kia dealer (tow the vehicle, if necessary) to protect it from potential theft.

*** NOTICE**

Smart key precautions

The smart key may not work if any of the following occur:

- The smart key is close to a radio transmitter such as a radio station or an airport which can interfere with normal operation of the smart key.
- The smart key is near a mobile two-way radio system or a cellular phone.
- Another vehicle's smart key is being operated close to your vehicle.

When the smart key does not work correctly, open and close the door with the mechanical key and contact an authorized Kia dealer.

If the smart key is in close proximity to your cell phone or smart phone, the signal from the smart key could be blocked by normal operation of your cell phone or smart phone. This is especially important when the phone is active, such as when making calls, receiving calls, text messaging, and/or sending/receiving emails. Avoid placing the smart key and your cell phone or smart phone in the same pants or jacket pocket and maintain adequate distance between the two devices.

* NOTICE

To prevent the electronic key from becoming damaged by magnetic fields, do not leave it near the following electrical appliances:

- TVs
 - Personal computers
 - Cellular phones, cordless phones and battery chargers
 - Table lamps
 - Induction cookers
-

* NOTICE

If you have to leave the vehicle's key with a parking attendant, remove the mechanical key for your own use and provide the attendant with the electronic key only.

* NOTICE

When bringing a smart key onto an airplane, make sure you do not press any button on the key while inside the cabin. If you are carrying the key in your bag etc., make sure that the buttons cannot be pressed accidentally. If you press a button, the key may emit radio waves that could interfere with the operation of the aircraft.

Folding key immobilizer system (if equipped)

Your vehicle may be equipped with an electronic engine immobilizer system to reduce the risk of unauthorized vehicle use.

Your immobilizer system is comprised of a small transponder in the ignition key and electronic devices inside the vehicle.

With the immobilizer system, whenever you insert your ignition key into the ignition switch and turn it to ON, it checks and determines and verifies that the ignition key is valid.

If the key is determined to be valid, the engine will start.

If the key is determined to be invalid, the engine will not start.

To deactivate the immobilizer system:

Insert the ignition key into the key cylinder and turn it to the ON position.

To activate the immobilizer system:

Turn the ignition key to the OFF position. The immobilizer system activates automatically. Without a valid ignition key for your vehicle, the engine will not start.

Your Immobilizer password is a customer unique password and should be kept confidential. Do not leave this number anywhere in your vehicle.

* NOTICE

Keep each key separately in order to avoid a starting malfunction.

* NOTICE

In order to prevent theft of your vehicle, do not leave spare keys anywhere in your vehicle. Your immobilizer password is a customer unique password should be kept confidential. Do not leave this number anywhere in your vehicle.

Do not put metal accessories near the ignition switch.

Metal accessories may interrupt the transponder signal and may prevent the engine from being started.

If you need additional keys or lose your keys, consult an authorized Kia dealer.

⚠ CAUTION

Immobilizer damage

Do not expose your immobilizer system to moisture, static electricity or rough handling. This may damage your immobilizer.

⚠ CAUTION**Immobilizer alterations**

Do not change, alter or adjust the immobilizer system because it could cause the immobilizer system to malfunction.

This device complies with Part 15 of the FCC rules.

Operation is subject to the following two conditions:

1. This device may not cause harmful interference, and
2. This device must accept any interference received, including interference that may cause undesired operation.

*** NOTICE**

Changes or modifications not expressly approved by the party responsible for compliance could void the user's authority to operate the equipment. If the smart key is inoperative due to changes or modifications not expressly approved by the party responsible for compliance, it will not be covered by your manufacturer's vehicle warranty.

Smart key immobilizer system

The immobilizer system protects your vehicle from theft. If an improperly coded key (or other device) is used, the vehicle's power system is disabled.

When the ENGINE START/STOP button is placed in the ON position, the immobilizer system indicator should come on briefly, then go off. If the indicator starts to blink, the system does not recognize the coding of the key.

Place the ENGINE START/STOP button in the OFF position, then place the ENGINE START/STOP button in the ON position again.

If the system repeatedly does not recognize the coding of the key, it is recommended that you contact your Kia dealer.

Do not attempt to alter this system or add other devices to it. Electrical problems could result that may make your vehicle inoperable.

If the following objects are placed near the ENGINE START/STOP button, there may be a problem with starting the engine.

1. Metal accessories
2. Another registered key
3. Keys registered in other vehicles
4. Electronic device

* NOTICE

When starting the vehicle, do not use the key with other immobilizer keys around. Otherwise, the vehicle may not start or may stop soon after it starts. Keep each key separate in order to avoid a starting malfunction.

This device complies with Part 15 of the FCC rules.

Operation is subject to the following two conditions:

1. This device may not cause harmful interference, and
2. This device must accept any interference received, including interference that may cause undesired operation.

* NOTICE

Changes or modifications not expressly approved by the party responsible for compliance could void the user's authority to operate the equipment. If the smart key is inoperative due to changes or modifications not expressly approved by the party responsible for compliance, it will not be covered by your manufacturer's vehicle warranty.

Theft-alarm system (if equipped)

This system is designed to provide protection from unauthorized entry into the vehicle.

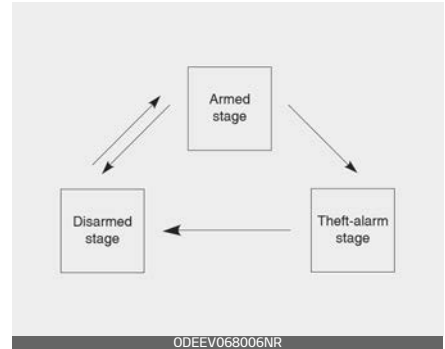

This system is operated in three stages: the first is the "Armed" stage, the second is the "Theft-alarm" stage, and the third is the "Disarmed" stage. If triggered, the system provides an audible alarm with blinking of the hazard warning lights.

Armed stage

Using the smart key

Park the vehicle and stop the engine. Arm the system as described below.

1. Turn off the engine.
2. Make sure that all doors, the hood and liftgate are closed and latched.

3. Lock the doors by pressing the button of the front outside door handle with the smart key in your possession.

After completion of the steps above, the hazard warning lights will operate once to indicate that the system is armed.

If any door (or liftgate) or hood remains open, the hazard warning lights and the chime will not operate and the theft-alarm will not arm. If all doors and liftgate and hood are closed after the lock button is pressed, the hazard warning lights blink once.

The system can also be armed by locking the doors with the key from the front doors; however, the hazard warning lights will not blink using this method.

4. Lock the doors by pressing the lock button on the smart key. After completion of the steps above, the hazard warning lights will operate once to indicate that the system is armed.

Using the folding key

Park the vehicle and stop the engine. Arm the system as described below.

1. Turn off the engine and remove the ignition key from the ignition switch.
2. Make sure that all doors (and liftgate) and the engine hood are closed and latched.
3. Lock the doors by pressing the lock button on the folding key.

After completion of the steps above, the hazard warning lights will blink once to indicate that the system is armed.

If any door (and liftgate) or engine hood remains open, the hazard warning lights won't operate and theft-alarm will not arm. After this, if all doors (and liftgate) and engine hood are closed, the hazard warning lights blink once.

*** NOTICE**

Do not arm the system until all passengers have left the vehicle. If the system is armed while a passenger(s) remains in the vehicle, the alarm may be activated when the remaining passenger(s) leaves the vehicle. If any door (or liftgate) or hood is opened within 30 seconds after the system enters the armed stage, the system will be disarmed to prevent unnecessary alarm.

Theft-alarm stage

The alarm will be activated if any of the following occurs while the system is armed.

- A front or rear door is opened without using the smart key.
- The liftgate is opened without using the smart key.
- The hood is opened.

The horn will sound and the hazard warning lights will blink continuously for approximately 27 seconds, and repeat the horn 3 times unless the system is disarmed. To turn off the system, unlock the doors with the folding key or smart key.

Disarmed stage

The system will be disarmed when:

Folding key

- The door unlock button is pressed.
- The engine is started. (within 3 seconds)
- The ignition switch is in the "ON" position for 30 seconds or more.

Smart key

- The door unlock button is pressed.
- The button of the front outside door is pressed while carrying the smart key.
- The engine is started. (within 3 seconds)

After pressing the unlock button, the hazard warning lights will blink and the chime will sound twice (in smart key) to indicate that the system is disarmed.

After pressing the unlock button, if any door (or liftgate) is not opened within 30 seconds, the system will be rearmed.

* NOTICE

- Avoid trying to start the engine while the alarm is activated. The vehicle starting motor is disabled during the theft-alarm stage. If the system is not disarmed with the folding key, insert the key into the ignition switch (if equipped), turn the ignition switch to the ON position and wait for 30 seconds. Then the system will be disarmed.
- If you lose your keys, consult your authorized Kia dealer.

⚠ CAUTION

Adjusting alarm system

Do not change, alter or adjust the theft alarm system in your vehicle. Improper installation of the alarm system could damage the vehicle or cause the system to malfunction.

* NOTICE

Malfunctions caused by improper alterations, adjustments or modifications to the theft-alarm system are not covered by your vehicle manufacturer warranty.

Door locks

Know how to use the door lock so that you can lock or unlock the door if necessary.

Operating door locks from outside the vehicle



1. Pull out the door handle.
 2. Press the lever (1) located inside the bottom part of the cover with a key or flat-head screwdriver.
 3. Push out the cover (2) while pressing the lever.
 4. Turn the key (3) toward the rear of the vehicle to unlock and toward the front of the vehicle to lock.
- If you lock the driver's door with a key, only the driver's door will lock/unlock.
 - From the driver's door, turn the key toward the rear of the vehicle once to unlock the driver's door and once more within 4 seconds to unlock all doors.
 - Doors can also be locked and unlocked with the smart key.

- Once the doors are unlocked, they may be opened by pulling the door handle.
- When closing the door, push the door by hand. Make sure the doors are closed securely.
- Before pulling the outside door handle, remove the key to avoid damaging the paintwork.

* NOTICE

- In cold and wet climates, door lock and door mechanisms may not work properly due to freezing conditions.
- If the door is locked/unlocked multiple times in rapid succession with either the vehicle key or door lock switch, the system may stop operating temporarily in order to protect the circuit and prevent damage to system components.

⚠ WARNING

- Securely close your door before you begin driving. Failure to fully close your door may cause it to open during vehicle operation.
- Keep your body out of the way of the closing door to prevent injuries.

⚠ WARNING

If any passengers must remain in the vehicle while it is very hot or cold outside, there is risk of injuries or danger to life. Do not lock the vehicle from the outside when there are passengers in the vehicle.

⚠ CAUTION

Do not unnecessarily open and close the door repeatedly or with excessive force. Such action can damage the vehicle door.

*** NOTICE**

Always place the ENGINE START/STOP button in the OFF position, engage the parking brake, close all windows, and lock all doors when leaving your vehicle unattended.

Operating door locks from inside the vehicle

You can operate door locks with the door lock handle or central door lock switch.

With the door handle

- Front door:
If the inner door handle (1) is pulled when the door is locked, the door will unlock and open.
- Rear door:
If the inner door handle is pulled once when the door is locked, the door will unlock.
If the inner door handle is pulled once more, the door will open.

Door lock malfunction

If a power door lock ever fails to function while you are in the vehicle, try one or more of the following techniques to exit:

- Operate the door unlock feature repeatedly (both electronic and manual) while simultaneously pulling on the door handle.
- Operate the other door locks and handles, front and rear.
- Lower a front window and use the key to unlock the door from outside.

⚠ WARNING

Do not pull the inner door handle of the driver's (or passenger's) door while the vehicle is moving.

With central door lock switch

Driver side



Passenger side



Operate by pressing the central door lock switch.

- When pressing the right portion (2) for the driver side or the upper portion (2) for the passenger side of the switch, all vehicle doors will lock.

- When pressing the left portion (1) for the driver side or the lower portion (1) for the passenger side of the switch, all vehicle doors will unlock.
- If the smart key is in the vehicle and any door is opened, the doors will not lock even though the right portion (2) for the driver side or upper portion (2) for the passenger side of the central door lock switch is pressed.

⚠ WARNING

Doors

- The doors should always be fully closed and locked while the vehicle is in motion to prevent accidental opening of a door.
- Be careful when opening doors and watch for vehicles, motorcycles, bicycles or pedestrians approaching the vehicle in the path of the door. Opening a door when something is approaching can cause damage or injury.

⚠ WARNING

Unattended children/animals

Never leave children or animals unattended in your vehicle. An enclosed vehicle can become extremely hot, causing death or severe injury to unattended chil-

dren or animals who cannot escape the vehicle.

Door lock/unlock features

The vehicle is equipped with door lock/unlock features for the safety and convenience of passengers.

Impact sensing door unlock system

All doors will automatically unlock when an impact causes the air bags to deploy.

Speed sensing door lock system

All doors will automatically lock after the vehicle speed exceeds 10 mph (15 km/h).

You can activate or deactivate the auto door lock/unlock features in the vehicle. Refer to "User Settings mode" on page 4-61.

If your vehicle is equipped with an infotainment system, you can learn how to setup on the website via QR code in the infotainment quick reference guide.

In case of an emergency

If the electrical power door lock switch is not operating (ex. dead car battery) the only way to lock the door(s) is with the mechanical key from the outside key hole.

Doors without an outside key hole can be locked as follows:

1. Open the door.
2. Insert the key into the emergency door lock hole and turn the key horizontally to lock.



3. Close the door securely.

*** NOTICE**

If the electrical power to door lock switch is not operating (ex. dead car battery) and the liftgate is closed, you will not be able to open the liftgate until power is restored.

Child-protector rear door lock

The child safety lock is provided to help prevent children from accidentally opening the rear doors from inside the vehicle.



OSP2N041057

The rear door safety locks should be used whenever children are in the vehicle.

The child safety lock is located on the edge of each rear door. When the child safety lock is in the lock position (1), the rear door will not open if the inner door handle is pulled.

To lock the child safety lock, insert a key (or screwdriver) into the hole and turn it to the lock position.

To allow a rear door to be opened from inside the vehicle, unlock the child safety lock.

To open the rear door, pull the outside door handle (2).

⚠ WARNING

Rear door locks

Use the rear door safety locks whenever children are in the vehicle. If a child accidentally opens the rear doors while the vehicle is moving, he or she may fall out.

Safe Exit Warning (SEW) (if equipped)

Safe Exit Warning is provided to help prevent passengers from opening their door by warning them when a vehicle approaching from the rear is detected after your vehicle has stopped.

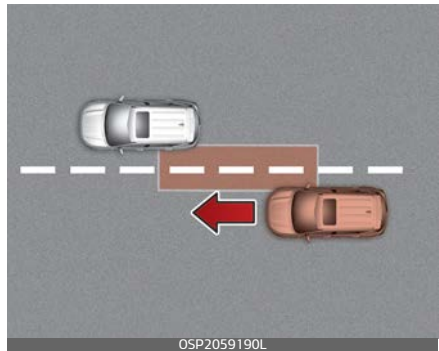

OSP2059190L

The "Check surroundings then try again" warning message appears on the cluster and a warning sounds.

When the function detects an approaching vehicle the moment a door is opened, the "Watch for traffic" warning message appears on the cluster and a warning sounds.

- The above functions are activated when you select 'Driver Assistance → Blind-Spot Safety → Safe Exit Assist' from the User Settings mode in the cluster LCD display.

If your vehicle is equipped with an infotainment system, you can learn how to setup on the website via QR code in the infotainment quick reference guide.

CAUTION

- Safe Exit Warning may not operate normally if there is any vehicle or obstacle at the rear area of your vehicle.
- Safe Exit Warning may not operate normally when a vehicle is coming rapidly two lanes over from your vehicle or a vehicle is approaching at a fast speed from the rear in the lane next to your vehicle.
- Safe Exit Warning may be activated later than normal or may not operate normally if a vehicle is approaching fast from the rear of your vehicle.
- Safe Exit Warning will not operate if there is a malfunction with Blind-Spot Collision Warning as follows:
 - When Blind-Spot Collision-Avoidance Assist warning message appears.

When BCA sensor or the sensor surrounding is polluted or covered.

- When BCA does not warn or warns wrongly.

For more details, refer to cautions and limitations in "Blind-Spot Collision-Avoidance Assist (BCA) (if equipped)" on page 5-113.

WARNING

- The function does not detect every obstacle approaching the vehicle exit.
- The driver and passenger are responsible for any obstacles while exiting the vehicle. Always check the surrounding before you exit the vehicle.

Rear Occupant Alert (ROA) system

The Rear Occupant Alert (ROA) is provided to help prevent exiting the vehicle with a rear passenger left in the vehicle.

- When you open the front door after opening and closing the rear door and turning off the engine, the "Check rear seats" warning message appears on the cluster.



You can activate or deactivate the ROA from the User Settings mode in the cluster LCD display. If your vehicle is equipped with an infotainment system, you can learn how to setup on the website via QR code in the infotainment quick reference guide..

The option can be found under the following menu:

1. Press the MODE button (☰) several times on the steering wheel until 'User Settings' menu appears on the LCD.
2. Select 'Convenience → Rear Occupant Alert' with the MOVE switch

(∧ / ∨) and the OK button on the steering wheel.

If your vehicle is equipped with the infotainment system, the option can be found under the following menu:

1. Press the SETUP button of the infotainment system.
2. Press 'Vehicle → Convenience → Rear Occupant Alert' on the infotainment system screen.

⚠ WARNING

The Rear Occupant Alert (ROA) system does not actually detect objects or people in the rear seat. By using a rear door opened and closed history, the system informs the driver that there may be something in the rear seat.

⚠ CAUTION

The Rear Occupant Alert (ROA) system uses a rear door opened and closed history.

The history is reset after the driver turns off ignition normally, gets off the vehicle and locks the door remotely using the remote keyless entry. So even if a rear door does not reopen, the ROA system warning can occur.

For example, after the ROA system warning occur, if the driver do not lock the door then ride and drive again, the warning can occur.

⚠ WARNING

The door lock system may not work if the electrical system is compromised. Accordingly, please train children passengers regarding how to open the car door manually before an emergency situation arises. That way, they would be able to open the door manually in the event an emergency situation arises.

Liftgate

When you open the liftgate, you will see a space where you can load the cargo.

Opening the liftgate

The liftgate is locked or unlocked when all doors are locked or unlocked with the mechanical key or central door lock/unlock switch.

⚠ CAUTION**Liftgate lift**

Make certain that you close the liftgate before driving your vehicle. Possible damage may occur to the liftgate gas lifters and attached hardware if the liftgate is not closed prior to driving.



To open the liftgate, press the handle and pull it up.

Once the liftgate is opened and then closed, the liftgate locks automatically. (All doors must be locked.)

* NOTICE

In cold and wet climates, door lock and door mechanisms may not work properly due to freezing conditions.

⚠ WARNING

The liftgate swings upward. Make sure no objects or people are near the rear of the vehicle when opening the liftgate.

Closing the liftgate



1. Lower and push down the liftgate firmly.
2. Make sure that the liftgate is securely latched.

Make sure your hands, feet and other parts of your body are safely out of the way before closing the liftgate.

⚠ WARNING

Exhaust Fumes

The liftgate should always be kept completely closed while the vehicle is in motion. If it is left open or ajar, poisonous exhaust gases may enter the car and serious illness or death may result.

Opening the liftgate in emergency

Your vehicle is equipped with the emergency liftgate safety release lever located on the bottom of the liftgate. When someone is inadvertently locked in the luggage compartment.



The liftgate can be opened by doing as follows:

1. Input the mechanical key into the hole.
2. Push the mechanical key to the right (1).
3. Push the liftgate upwards.

⚠ WARNING

- No one should be allowed to occupy the cargo area of the vehicle at any time. The cargo area is a very dangerous location in the event of a crash.
- Use the release lever for emergencies only. Use with extreme caution, especially while the vehicle is in motion.

⚠ CAUTION

Make sure there are no people or objects around the liftgate before opening or closing the liftgate. Wait until the liftgate is open fully and stopped before loading or unloading cargo from the vehicle.

⚠ WARNING

Do not grasp the part supporting the liftgate (gas lifter), as this may cause serious injury.



Windows

The doors of this vehicle are equipped with power windows that can be operated by a switch.

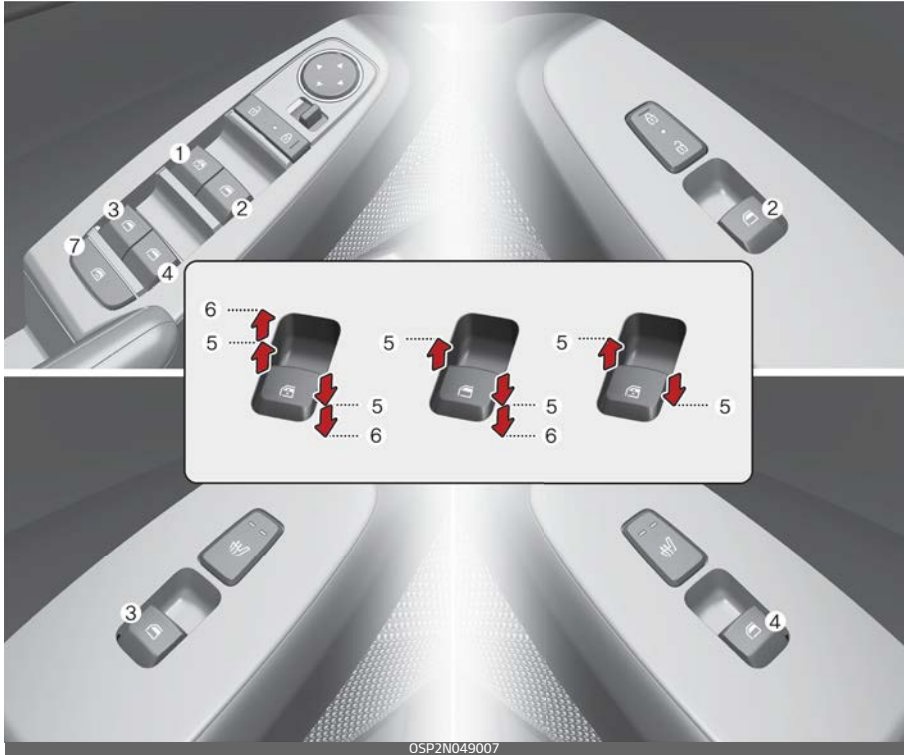

OSP2N049007

1. Driver's door power window switch
2. Front passenger's door power window switch*
3. Rear door (left) power window switch*
4. Rear door (right) power window switch*
5. Window opening and closing
6. Automatic power window up*/down*
7. Power window lock switch

*: if equipped

*** NOTICE**

In cold and wet climates, power windows may not work properly due to freezing conditions.

The ENGINE START/STOP button must be in the ON position for power windows to operate.

Each door has a power window switch that controls the door's window. The driver has a power window lock switch which can block the operation of rear passenger windows. The power windows can be operated for approximately 10 minutes after the ENGINE START/STOP button or the ignition switch has been placed in the ACC or OFF position. However, if the front doors are opened, the power windows cannot be operated even within the 10 minutes period.

The driver's door has a master power window switch that controls all the windows in the vehicle.

If the window cannot be closed because it is blocked by objects, remove the objects and close the window.

*** NOTICE**

While driving with the rear windows down or with the sunroof (if equipped) in an open (or partially open position), your vehicle may demonstrate a wind buffeting or pulsation noise. This noise is a normal occurrence and can be reduced or eliminated by taking the following actions. If the noise occurs with one or both of the rear windows down, partially lower both front windows approximately 1 in (2.5 cm). If you experience the noise with the sunroof open, slightly reduce the size of the sunroof opening.

⚠ CAUTION

Do not install any accessories in the vehicle that extend into the open window area. Such objects will impact the proper function of the Automatic reversal "jam protection" feature.

*** NOTICE**

If you press the one-touch window button for micro adjustment, the glass will go down to a specific location to improve your convenience.

Window opening and closing

You can open and close windows using the power window switch.

Type A



To open or close a window, press down or pull up the front portion of the corresponding switch to the first detent position (5).

Type B - Auto down window (if equipped)

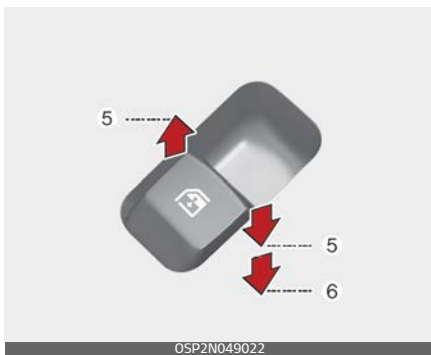

Pressing the power window switch momentarily to the second detent position (6) completely lowers the window even when the switch is

released. To stop the window at the desired position while the window is in operation, pull up the switch briefly to the opposite direction of the window movement.

Type C - Auto up/down window (if equipped)



Pressing or pulling up the power window switch momentarily to the second detent position (6) completely lowers or raises the window even when the switch is released. To stop the window at the desired position while the window is in operation, pull up or press down and release the switch.

If the power window does not operate normally, the automatic power window system must be reset as follows:

1. Turn the ignition switch to the ON position.
2. Close the window and continue pulling up the power window

switch for at least 1 second after the window is completely closed.

Automatic reversal (if equipped)

If the upward movement of the window is blocked by an object or part of the body, the window will detect the resistance and will stop upward movement. The window will then lower approximately 11.8 in (30 cm) to allow the object to be cleared.



If the window detects the resistance while the power window switch is pulled up continuously, the window will stop upward movement then lower approximately 1 in (2.5 cm).

If the power window switch is being continuously pulled up again within 5 seconds after the window was lowered by the automatic window reversal feature, the automatic window reversal will not operate.

*** NOTICE**

The automatic reverse feature for the window is only active when the "auto up" feature is used by fully pulling up the switch. The automatic reverse feature will not operate if the window is raised using the half-way position on the power window switch.

⚠ WARNING

Always check for obstructions before raising any window to avoid injuries or vehicle damage. If an object less than 0.16 in (4 mm) in diameter is caught between the window glass and the upper window channel, the automatic reverse window may not detect the resistance and will not stop and reverse direction.

⚠ WARNING

The automatic reverse feature doesn't activate while resetting the power window system. Make sure body parts or other objects are safely out of the way before closing the windows to avoid injuries.

⚠ WARNING

Do not install any accessories in the vehicle that extend into the open

window area. Such objects could prevent the automatic reverse feature from functioning.

Power window lock button

The driver can disable the power window switches on the rear passengers' doors by pressing the power window lock button to the lock position (pressed).



When the power window lock button is pressed:

- The driver's master control can operate all passengers' power windows.
- The front passenger's control can operate the front passenger's power window.
- The rear passengers' control cannot operate the rear passenger's power window.

Always double check to make sure all arms, hands, head and other obstructions are safely out of the way before closing a window.

If the window cannot be closed because it is blocked by objects, remove the objects and close the window.

⚠ WARNING

Power windows

- Do not allow children to play with the power windows. Keep the power window lock switch (on the driver's door) in the LOCK (pressed) position.
 - Do not extend a face or arms outside the window opening while the vehicle is in motion. Doing so could result in significant bodily injury.
-

⚠ WARNING

- When exiting the vehicle, turn the engine switch off, take the key with you, and make sure that all children have also exited the vehicle. If a child is left alone inside the vehicle, they may accidentally operate the vehicle, which could lead to an accident or injury.
 - Do not leave children, seniors, or animals in your vehicle with the doors and windows closed.
 - Do not allow a child to hold both the remote control key and the mechanical key together.
-

Hood

The hood serves as a cover for the engine compartment. Open the hood if maintenance work needs to be performed in the engine compartment or if you need to look at the compartment.

Opening the hood

1. Pull the release lever to unlatch the hood. The hood should pop open slightly.

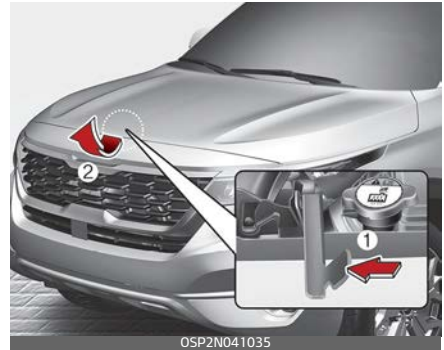

3. Pull out the support rod.



4. Hold the hood opened with the support rod.

⚠ WARNING

Open the hood after turning off the engine on a flat surface, shifting the shift lever to the P (Park) position and setting the parking brake.

2. Go to the front of the vehicle, raise the hood slightly, push the secondary latch (1) sideways and lift the hood (2).

Hood open warning

A warning message will appear on the LCD display when hood is open.



The warning chime will operate when the vehicle is being driven above 2 mph (3 km/h) with the hood open.

Closing the hood

1. Before closing the hood, check the following:
 - All filler caps in the engine compartment must be correctly installed.
 - Gloves, rags or any other combustible material must be removed from the engine compartment.
2. Lower the hood halfway (approximately 30 cm) and push down to securely lock in place.
3. Then double check to be sure the hood is secure.
 - If the hood can be raise slightly, it is not properly engaged.
 - Open it again and close it with a little more force.

⚠ CAUTION

Hood obstruction

Before closing the hood, ensure that all obstructions are removed from the hood opening. Closing the hood with an obstruction present in the hood opening may result in severe personal injury or property damage.

⚠ WARNING

Fire risk

Do not leave gloves, rags or any other combustible material in the motor compartment. Doing so may cause a heat-induced fire.

⚠ WARNING

Unsecured hood

Always double check to be sure that the hood is firmly latched before driving away. If it is not latched, the hood could fly open while the vehicle is being driven, causing a total loss of visibility, which may result in an accident.

Fuel filler door

The vehicle's fuel filler door must be opened and closed by hand from outside the vehicle.

Opening the fuel filler door



If the fuel filler door does not open because ice has formed around it, tap lightly or push on the lid to break the ice and release the lid. Do not apply excessive force to open the lid. If necessary, spray around the lid with an approved de-icer fluid (do not use radiator anti-freeze) or move the vehicle to a warm place and allow the ice to melt.

1. Stop the engine.
2. To open the fuel filler door, pull up the fuel filler door opener.



3. Pull the fuel filler door (1) out to fully open.

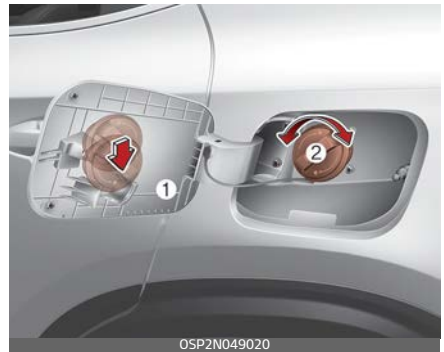

4. To remove the fuel tank cap (2), turn it counterclockwise. You may hear a hissing noise as the pressure inside the tank equalizes.
5. Place the cap on the fuel filler door.

⚠ WARNING

Before refueling, be sure to check what type of fuel is used for your vehicle.

If you put diesel fuel into a gasoline-powered vehicle or gasoline into a diesel-powered vehicle, it may

affect the fuel system and cause serious damage to the vehicle.

Closing the fuel filler door

1. To install the cap, turn it clockwise until it "clicks" one time. This indicates that the cap is securely tightened.
2. Close the fuel filler door and push on it lightly gently to make sure that it is securely closed.

WARNING

Refueling

Always remove the fuel cap carefully and slowly. If the cap is venting fuel or if you hear a hissing sound, wait until the condition stops before completely removing the cap.

If pressurized fuel sprays out, it can cover your clothes or skin and subject you to the risk of fire and burns.

* NOTICE

When refueling on unlevel ground, the fuel gauge may not point to the F position. It is not a malfunction. If you move your vehicle to a level ground, the fuel gauge will move to the full position.

* NOTICE

Tighten the cap until it clicks one time, otherwise, the engine warning indicator light will illuminate.

Always check that the fuel cap is installed securely to prevent fuel spillage in the event of an accident.

WARNING

Fire/explosion risk

Read and follow all warnings posted at the gas station facility. Failure to follow all warnings will result in severe personal injury, severe burns or death due to fire or explosion.

WARNING

Static electricity

- Before touching the fuel nozzle, you should eliminate potentially dangerous static electricity discharge by touching another metal part of the vehicle, a safe distance away from the fuel filler neck, nozzle, or other gas source.
- Do not get back into a vehicle once you have begun refueling since you can generate static electricity by touching, rubbing or sliding against any item or fabric (polyester, satin, nylon, etc.) capable of producing static electricity. Static electricity discharge can ignite fuel vapors resulting in

rapid burning. If you must reenter the vehicle, you should once again eliminate potentially dangerous static electricity discharge by touching a metal part of the vehicle, away from the fuel filler neck, nozzle or other gasoline source.

WARNING

Portable fuel container

When using an approved portable fuel container, be sure to place the container on the ground prior to refueling. Static electricity discharge from the container can ignite fuel vapors causing a fire. Once refueling has begun, contact with the vehicle should be maintained until the filling is complete. Use only approved portable plastic fuel containers designed to carry and store gasoline.

WARNING

Cell phone fires

Do not use cellular phones while refueling. Electric current and/or electronic interference from cellular phones can potentially ignite fuel vapors causing a fire.

WARNING

Refueling & Vehicle fires

When refueling, always shut the engine off. Sparks produced by electrical components related to the engine can ignite fuel vapors causing a fire. Once refueling is complete, check to make sure the filler cap and filler door are securely closed, before starting the engine.

WARNING

Smoking

DO NOT use matches or a lighter and DO NOT SMOKE or leave a lit cigarette in your vehicle while at a gas station especially during refueling. Automotive fuel is highly flammable and can, when ignited, result in fire.

Make sure to refuel your vehicle according to "Fuel requirements" on page 1-2.

If the fuel filler cap requires replacement, use only a genuine Kia cap or the equivalent specified for your vehicle. An incorrect fuel filler cap can result in a serious malfunction of the fuel system or emission control system.

⚠ CAUTION**Exterior paint**

Do not spill fuel on the exterior surfaces of the vehicle. Any type of fuel spilled on painted surfaces may damage the paint.

⚠ WARNING

- Do not allow anyone that has not discharged static electricity from their body to come close to an open fuel tank.
 - Do not inhale vaporized fuel.
-

⚠ WARNING**Risk of injury from fuel**

Fuels are poisonous and harmful to your health.

- Fuel contains substances that are harmful if inhaled.
- Do not swallow fuel or let it come into contact with skin, eyes or clothing.
- Do not inhale fuel vapors.
- Keep children away from fuel.

If you or other people come into contact with fuel, observe the following:

- Immediately rinse fuel off your skin with soap and water.
- If fuel comes into contact with your eyes, immediately rinse them thoroughly with clean

water. Seek medical attention immediately.

- If you swallow fuel, seek medical attention immediately. Do not induce vomiting.
 - Change immediately out of clothing that has come into contact with fuel.
-

*** NOTICE****Damage caused by the wrong fuel**

Fuel that does not conform to the required quality can lead to increased wear as well as damage to the engine and exhaust system. Only use the fuel recommended.

*** NOTICE****Damage caused by the wrong fuel**

Vehicles with a gasoline engine: Even small amounts of the wrong fuel could result in damage to the fuel system, the engine and the emission control system.

*** NOTICE**

Do not use diesel to refuel vehicles with a gasoline engine.

* NOTICE

Do not switch on the ignition if you accidentally refuel with the wrong fuel. Otherwise, fuel can enter the fuel system.

Even small amounts of the wrong fuel could result in damage to the fuel system and the engine. Have the system serviced by an authorized Kia dealer.

* NOTICE

Do not overfill the fuel tank

Do not overfill the fuel tank; otherwise fuel may slide, causing harm to the environment and damaging the vehicle.

Sunroof (if equipped)

If your vehicle is equipped with a sunroof, you can slide or tilt your sunroof with the sunroof switch located on the overhead console.



The sunroof can only be operated when the ignition switch or the ENGINE START/STOP button is in the ON position.

The sunroof can be operated for approximately 10 minutes after the ignition switch or the ENGINE START/STOP button is in the ACC or OFF position. However, if the front door is open, the sunroof cannot be operated even within the 10 minutes period.

⚠ WARNING

- Never adjust the sunroof or sunshade while driving. This could result in loss of control and an accident that may cause injury, or property damage.

- Do not leave the engine running and the key in your vehicle with unsupervised children. Unattended children could operate the sunroof, which could result in serious injury.
- Do not sit on the top of the vehicle. It may cause injury or vehicle damage.

*** NOTICE**

Do not operate the sunroof when the roof bars are installed on the vehicle or when there is luggage on the roof.

*** NOTICE**

The sunshade will open automatically when the sunroof glass moves, but the sunshade does not close automatically when the sunroof glass is closed. Also, only the sunshade cannot be closed when the sunroof glass is opened.

*** NOTICE**

Do not pull the sunshade up or down, or apply excessive force as such action may damage the sunshade or cause it to malfunction.

Sunshade

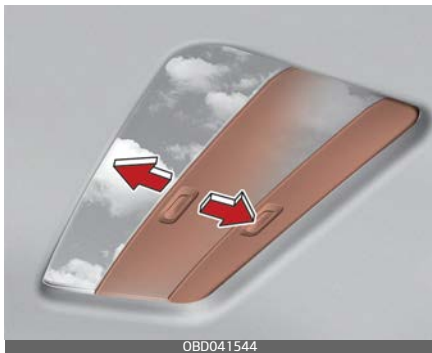

OBD041544

Use the sunshade to block direct sunlight coming through the sunroof glass.

Open or close the sunshade by hand.

Tilt open/close



OSP2N049041

- Push the sunroof switch upward, the sunroof glass will tilt open.
- Push the sunroof switch forward, the sunroof glass will automatically close.

To stop the sunroof movement at any point, push the sunroof switch in any direction.

* NOTICE

The sunroof glass cannot slide open and tilt open at the same time. You cannot tilt open while the sunroof glass is slide open, and you cannot slide open while the sunroof is tilt open. Slide open or tilt open with the sunroof glass when the sunroof glass is completely closed.

Slide open/close



- Push the sunroof switch rearward, the sunshade and sunroof glass will slide open. Push the sunroof switch forward, only the sunroof glass will close.
- Push the sunroof switch forward or rearward to the first detent position, the sunroof glass will operate manually. Push the sunroof switch forward or rearward to the second detent position, the sunroof glass will operate automatically (auto slide feature).

To stop the sunroof movement at any point, push the sunroof switch in any direction.

* NOTICE

To reduce wind noise while driving, we recommend you to drive at the recommended position before the maximum slide open position.

Automatic reversal

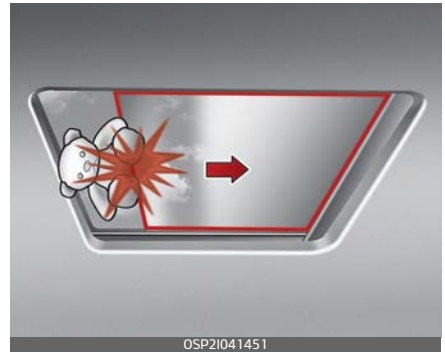

If the sunroof senses any obstacle while it is closing automatically, it will reverse direction then stop at a certain position.

The auto reverse function may not work if an object thin or soft is caught, or the sunroof is closed manually.

⚠ WARNING

- Make sure heads, hands, arms or any other body parts or objects are out of the way before operating the sunroof. Body parts or

objects may get caught causing injuries or vehicle damage.

- Never deliberately use your body parts to test the automatic reversal function. The sunroof glass may reverse direction, but there is a risk of injury.

* NOTICE

- Do not continue to push the sunroof switch after the sunroof is fully opened, closed, or tilted. Damage to the sunroof motor could occur.
- Continuous operations such as slide open/close, tilt open/close, etc. may cause the motor or sunroof system to malfunction.
- Regularly remove any accumulated dust on the sunroof rail.
- Using the sunroof for a long time can make noise caused by dust in accumulated between the sunroof and vehicle body. Open the sunroof and remove dust regularly using a clean cloth.
- Do not try to open the sunroof when the temperature is below freezing or when the sunroof is covered with snow or ice, otherwise the motor could be damaged. In cold and wet climates, the sunroof may not work properly.
- Do not open or drive with the sunroof glass open immediately after rain or washing the vehicle.

Water may wet the interior of the vehicle.

- Do not extend any luggage outside the sunroof while driving. Vehicle damage may occur if the vehicle suddenly stops.

⚠ WARNING

Do not extend your head, arms, body parts or objects outside the sunroof while driving. Injuries may occur if the vehicle suddenly stops.

Resetting the sunroof



In some circumstances resetting the sunroof operation may need to be performed. Some instances where resetting the sunroof may be required include:

- When the 12 volt battery is either disconnected or discharged
- When the sunroof fuse is replaced
- If the sunroof one-touch AUTO OPEN/CLOSE operation is not functioning properly

Sunroof resetting procedure:

1. It is recommended to perform the reset procedure with the vehicle engine running. Start the vehicle in P (Park).
2. Make sure the sunroof glass is in the fully closed position. If the sunroof glass is open, push the switch forward until the sunroof glass is fully closed.
3. Release the switch when the sunroof glass is fully closed.
4. Push the switch forward until the sunroof glass moves slightly. Then release the switch.
5. Within 3 seconds, push and hold the sunroof switch forward until the sunroof glass slides open and close. Do not release the switch until the operation is completed. If you release the switch during operation, start the procedure again from step 2.

* NOTICE

If the sunroof is not reset when the vehicle battery is disconnected or discharged, or the sunroof fuse is blown, the sunroof may not operate normally.

Sunroof open warning



If the driver turns off the engine when the sunroof is not fully closed, the warning chime will sound for several seconds and the sunroof open warning will appear on the cluster LCD display.

Close the sunroof securely when leaving your vehicle.

⚠ CAUTION

Make sure the sunroof is closed fully when leaving your vehicle. If the sunroof is left open, rain or snow may wet the interior of the vehicle. Also, leaving the sunroof open when the vehicle is unattended may invite theft.

Steering wheel

The steering wheel of this vehicle is equipped with the Electric Power Steering (EPS) system.

Electric Power Steering (EPS)

Electric power steering is a device that uses an electric motor to help the driver provide less effort in steering the vehicle.

If the vehicle is off or if the Electric Power Steering (EPS) becomes inoperative, the vehicle may still be steered, but it will require increased steering effort.

The EPS is controlled by the power steering control unit which senses the steering wheel torque and vehicle speed to command the motor.

The steering effort becomes heavier as the vehicle's speed increases and becomes lighter as the vehicle's speed decreases for better control of the steering wheel.

Should you notice any change in the effort required to steer during normal vehicle operation, have the power steering checked by an authorized Kia dealer.

* NOTICE

The following symptoms may occur during normal vehicle operation:

- When the ENGINE START/STOP button is the ON position, the steering wheel enters normal operation mode after diagnosing the Electric Power Steering system (for about 3 seconds).
- A click noise may be heard from the EPS relay after turning the ENGINE START/STOP button is turned to the ON or OFF position.
- If the steering wheel is operated when the vehicle is not in motion or driven at a low speed, you may hear some noise.
- If the Electric Power Steering system does not operate normally, the warning light will illuminate or blink on the instrument cluster. If the power assistance of steering fails, you will need to use more force to steer.
- Operating the steering wheel at lower temperatures may require more force and accompany noise. However, when the temperature increases, it returns to normal.
- Take your vehicle to an authorized Kia dealer and have the vehicle checked as soon as possible.
- When the charging system warning light comes on due to the low voltage (when the alternator or battery does not operate normally or malfunctions), the steering wheel may require increased steering effort.

⚠ CAUTION

When you continuously operate the steering wheel, the over current protection device is activated and it requires more force to operate the steering wheel. However, this doesn't indicate a malfunction, and it works for your safety and will return to normal after some time.

⚠ CAUTION

If the Electric Power Steering (EPS) system does not work or an error occurs, the warning light on the instrument panel may be turned on or blink and it may require more force to operate the steering wheel. In this case, please hold the steering wheel more tightly than usual and operate with greater force. And then immediately pull your vehicle over to a safe place and have your vehicle inspected by an authorized Kia dealer.

If the EPS does not operate normally, the warning light will illuminate on the instrument cluster. The steering wheel may become difficult to control or operate abnormally. In this case, have the system inspected by an authorized Kia dealer.

When you operate the steering wheel in low temperature, the

steering effort may be high and abnormal noise could occur. If temperature rises, the noise will disappear. This is a normal condition.

When the vehicle is stationary, and the steering wheel is turned all the way to the left or right continuously, the steering wheel becomes harder to turn. The power assist is limited to protect the motor from overheating.

As time passes, the steering wheel will return to its normal condition.

Tilt & telescopic steering wheel

A tilt and telescopic steering wheel allows you to adjust the steering wheel before you drive.

You can also raise it to give your legs more room when you exit and enter the vehicle.

The steering wheel should be positioned so that it is comfortable for you to drive, while permitting you to see the instrument panel warning lights and gauges.

⚠ WARNING**Steering wheel adjustment**

Never adjust the angle and height of the steering wheel while driving. You may lose steering control.

Adjusting steering wheel angle and height

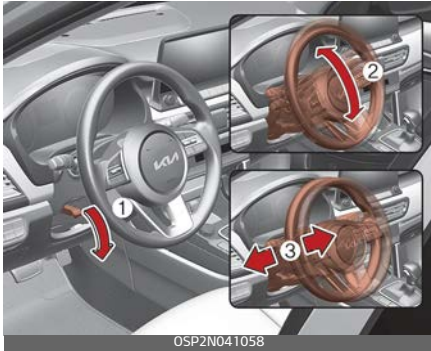

1. To change the steering wheel angle, pull down the lock release lever (1).
2. Adjust the steering wheel to the desired angle (2) and height (3).
3. Pull up the lock-release lever to lock the steering wheel in place.
4. Be sure to adjust the steering wheel to the desired position before driving.

*** NOTICE**

After adjustment, sometimes the lock-release lever may not lock the steering wheel.

It is not a malfunction. This occurs when two gears engage. In this case, adjust the steering wheel again and then lock the steering wheel.

Heated steering wheel (if equipped)

With the ENGINE START/STOP button in the ON position, pressing the

heated steering wheel button warms the steering wheel. The indicator on the button will illuminate.



To turn the heated steering wheel off, press the button once again. The indicator on the button will turn off.

*** NOTICE**

The heated steering wheel will turn off automatically approximately 30 minutes after the heated steering wheel is turned on.

⚠ CAUTION

- Do not install any type of grip cover for the steering wheel, it may impair the function of the heated steering wheel system.
- When cleaning the heated steering wheel, do not use an organic solvent such as paint thinner, benzene, alcohol and gasoline. Doing so may damage the surface of the steering wheel.

- If the surface of the steering wheel is damaged by a sharp object, damage to the heated steering wheel components could occur.

⚠ WARNING

If the steering wheel becomes too warm, turn the system off. The heated steering wheel may cause burns even at low temperatures, especially if used for long periods of time.

Horn

To sound the horn, press the area indicated by the horn symbol on your steering wheel (see illustration).



The horn will operate only when this area is pressed. Check the horn regularly to be sure it operates properly.

Mirrors

This vehicle is equipped with inside and outside rearview mirrors to provide views of objects behind the vehicle.

Inside rearview mirror

Adjust the rearview mirror so that the center view through the rear window is seen. Make this adjustment before you start driving.

Do not place objects in the rear seat or cargo area which would interfere with your vision through the rear window.

⚠ WARNING

Mirror adjustment

Do not adjust the rearview mirror while the vehicle is moving. This could result in loss of control.

*** NOTICE**

Do not modify the inside mirror in any manner, including installing a wide mirror. Doing so could result in injury during an accident or deployment of the air bag.

⚠ CAUTION

Cleaning mirror

When cleaning the mirror, use a paper towel or similar material dampened with glass cleaner. Do not spray glass cleaner directly on the mirror. It may cause the liquid cleaner to enter the mirror housing.

Electric Chromic Mirror (ECM) (if equipped)

The electric rearview mirror automatically controls the glare from the headlights of the vehicles behind you at night or in low-light driving conditions.

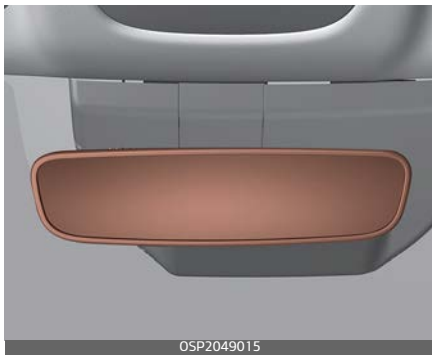

The sensor mounted in the mirror senses the light level around the vehicle, and automatically controls the headlight glare from the vehicles behind you.

When the engine is running, the glare is automatically controlled by the sensor mounted in the rearview mirror. Whenever the shift lever is shifted into reverse (R), the mirror will automatically go to the brightest setting in order to improve the drivers view behind the vehicle.

⚠ CAUTION

Cleaning mirror

When cleaning the mirror, use a paper towel or similar material dampened with glass cleaner. Do not spray glass cleaner directly on the mirror. It may cause the liquid cleaner to enter the mirror housing.

Day/night rearview mirror (if equipped)

Make this adjustment before you start driving and while the day/night lever is in the day position (1).

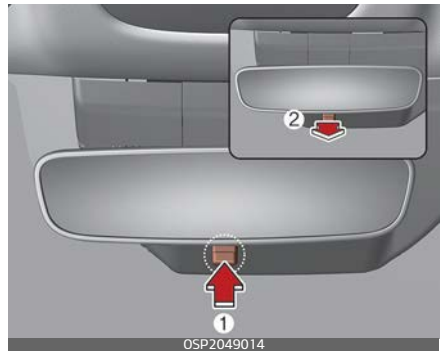

* (1): Day, (2): Night

Pull the day/night lever toward you (2) to reduce the glare from the headlights of the vehicles behind you when driving at night.

Remember that you lose some rearview clarity in the night position.

This device complies with Part 15 of the FCC rules.

1. This device may not cause harmful interference, and
2. This device must accept any interference received, including interference that may cause undesired operation.

The transceiver has been tested and complies with FCC and Industry Canada rules. Changes or modifications not expressly approved by the party responsible for compliance could void the user's authority to operate the device.

Outside rearview mirror

Your vehicle is equipped with both left-hand and right-hand outside rearview mirrors.

Be sure to adjust the mirror angles before driving.

The mirrors can be adjusted remotely with the remote switch. The mirror heads can be folded back to prevent damage during an automatic car wash or when passing through a narrow street.

⚠ WARNING

Estimating distances accurately

Objects reflected in the mirror are closer than they appear in the mirror. Do not estimate the distance of vehicles behind you based on what you see in the mirror, as this could increase your risk of accident. (The convex mirrors are only used for the passenger side rearview mirrors.)

If the mirror is jammed with ice, do not adjust the mirror by force. Use an approved spray de-icer (not radiator antifreeze) to release the frozen mechanism or move the vehicle to a warm place and allow the ice to melt.

⚠ WARNING

Mirror adjustment

Do not adjust or fold the outside rearview mirrors while the vehicle is moving. This could result in loss of control.

Adjusting the outside rearview mirrors



Adjusting the rearview mirrors:

1. Move the L (Front left side) or R (Front right side) switch (1) to select the rearview mirror you would like to adjust.
2. Use the mirror adjustment control (2) to position the selected mirror up, down, left or right.

⚠ CAUTION

- The mirrors stop moving when they reach the maximum adjusting angles, but the motor continues to operate while the switch is pressed. Do not press the switch longer than necessary, the motor may be damaged.
- Do not attempt to adjust the outside rearview mirror by hand. Doing so may damage the parts.

Folding the outside rearview mirror

- To fold the outside rearview mirror, grasp the housing of the mirror and then fold it toward the rear of the vehicle.



Instrument cluster

Type A



OSP2N049100

Type B



OSP2N049101

* The actual cluster and contents of the LCD display in the vehicle may differ from the illustration.

1. Tachometer
2. Speedometer
3. Engine coolant temperature gauge
4. Fuel gauge
5. LCD display
6. Warning and indicator lights

Instrument cluster control

The brightness of the instrument panel illumination is changed by pressing the illumination control button ("+" or "-") when ENGINE START/STOP button is ON, or the taillights are turned on.

- If you hold the illumination control button ("+" or "-"), the brightness will continuously change.

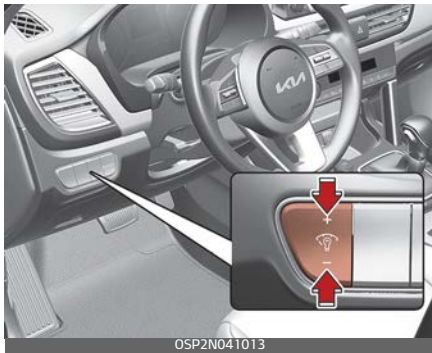

OSP2N041013

- If the brightness reaches to the maximum or minimum level, an alarm will sound.



OSP21049105

Gauges

The gauges display various information such as the speed of the vehicle, the amount of charge of the battery, and so on.

Speedometer



OSP2049137L

The speedometer indicates the speed of the vehicle and is calibrated in miles per hour (mph) and/or kilometers per hour (km/h).

Tachometer



OSP21049107

The tachometer indicates the approximate number of engine revolutions per minute (rpm).

Use the tachometer to select the correct shift points and to prevent lugging and/or over-revving the engine.

⚠ CAUTION

Do not operate the engine within the tachometer's RED ZONE. This may cause severe engine damage.

Engine Coolant Temperature Gauge



This gauge indicates the temperature of the engine coolant when the ENGINE START/STOP button is ON.

⚠ CAUTION

If the gauge pointer moves beyond the normal range area toward the "H" position, it indicates overheating that may damage the engine.

Do not continue driving with an overheated engine. If your vehicle overheats, refer to "If the engine overheats" on page 6-8.

⚠ WARNING

Never remove the radiator cap when the engine is hot. The engine coolant is under pressure and could severely burn. Wait until the engine is cool before adding coolant to the reservoir.

Fuel Gauge



This gauge indicates the approximate amount of fuel remaining in the fuel tank.

* NOTICE

- The fuel tank capacity is given in "Recommended lubricants and capacities" on page 8-7.
- The fuel gauge is supplemented by a low fuel warning light, which will illuminate when the fuel tank is nearly empty.
- On inclines or curves, the fuel gauge pointer may fluctuate or the low fuel warning light may

come on earlier than usual due to the movement of fuel in the tank.

⚠ WARNING

Fuel Gauge

Running out of fuel can expose vehicle occupants to danger.

You must stop and obtain additional fuel as soon as possible after the warning light comes on or when the gauge indicator comes close to the "E" level.

⚠ CAUTION

Avoid driving with an extremely low fuel level. Running out of fuel could cause the engine to misfire, which could damage the catalytic converter.

*** NOTICE**

The fuel display may not be accurate if the vehicle is on an incline.

Odometer



The odometer indicates the total distance that the vehicle has been driven and should be used to determine when periodic maintenance should be performed.

- Odometer range: 0~999,999 miles or 0~1,599,999 kilometers.

Outside Temperature Gauge

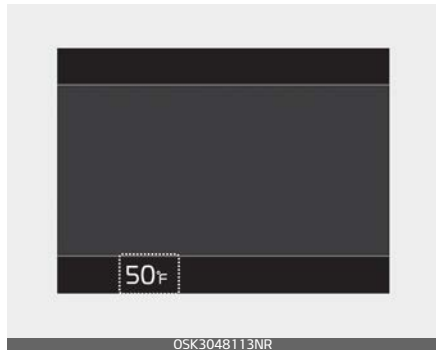

This gauge indicates the current outside air temperatures by 1 °F (1 °C).

- Temperature range: -40~140 °F (-40~60 °C)

The outside temperature on the display may not change immediately, like a normal thermometer would, so as to prevent the driver from being distracted.

To change the temperature unit (from °F to °C or from °C to °F)

The temperature unit can be changed by using the "User Settings" mode of the LCD display.

If your vehicle is equipped with an infotainment system, you can learn how to setup on the website via QR code in the infotainment quick reference guide.

* For more details, refer to "LCD display" on page 4-58.

Transmission shift indicator

Transmission shift indicator displays gear information depending on your vehicle's transmission type.

Intelligent variable transmission shift indicator (if equipped)

This indicator displays which automatic transmission shift lever is selected.

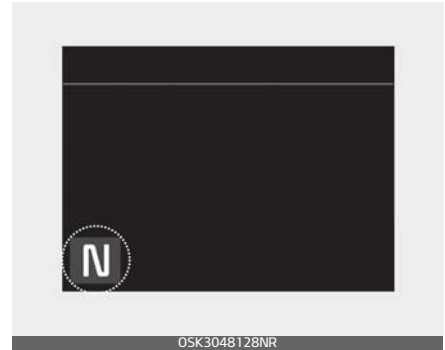

- Park: P
- Reverse: R
- Neutral: N
- Drive: D
- Sports Mode: 1, 2, 3, 4, 5, 6

Dual clutch transmission shift indicator (if equipped)

This indicator displays which shift lever is selected.

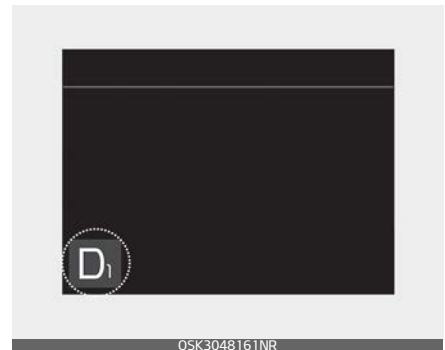

- Park: P
- Reverse: R
- Neutral: N
- Drive: D
- Sports Mode: S



LCD display

The LCD display shows trip computer and other information.

LCD Display Control

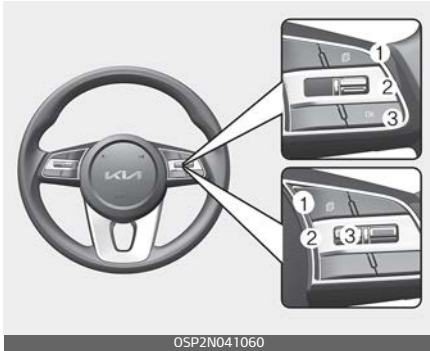





The LCD display modes can be changed by using the control buttons.



1. : MODE button for changing modes
2. : MOVE switch for changing items
3. OK: SELECT/RESET button for setting or resetting the selected item

LCD Display Modes

You can switch modes by pressing the Mode button.

		Mode				
		 Trip Computer	 Turn By Turn (TBT)*	 Driving Assist	 User Settings	 Master warning
 Up/Down	Fuel Economy	Route Guidance	SCC*/ Lane Safety	Head-Up Display	The Master Warning mode displays warning messages related to the vehicle when one or more systems is not operating normally.	
	Accumulated Info	Destination Info	Driver Attention Warning*	Driver Assistance		
	Drive Info		AWD*	Door		
	Transmission Temperature		TPMS	Lights		
		Convenience				
	Service Interval					
	Other features					
			Language			
			Reset			

4

The information provided may differ depending on which functions are applicable to your vehicle.

* NOTICE

Keep the engine running when configuring the display settings to prevent the battery from discharging.

Trip Computer mode

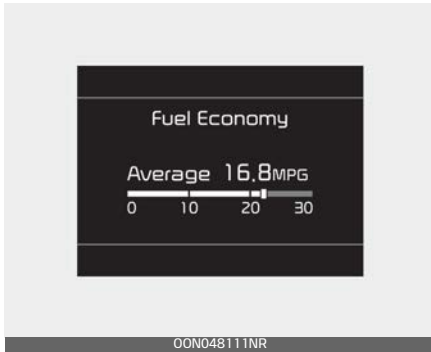

The trip computer mode displays information related to vehicle driving parameters including fuel economy, tripmeter information and vehicle speed.

* For more details, refer to "Trip information (trip computer)" on page 4-68.

Turn By Turn (TBT) mode



This mode displays the state of the navigation.

Driving Assist mode



This mode displays the state of:

- SCC (if equipped)
- Lane Safety (if equipped)
- Driver Attention Warning (if equipped)
- AWD (if equipped)
- Tire pressure

* For more details, refer to each function information in "Driving your vehicle" on page 5-7.

Tire pressure status

* For more details, refer to "Tire Pressure Monitoring System (TPMS)" on page 6-10.

Master warning mode

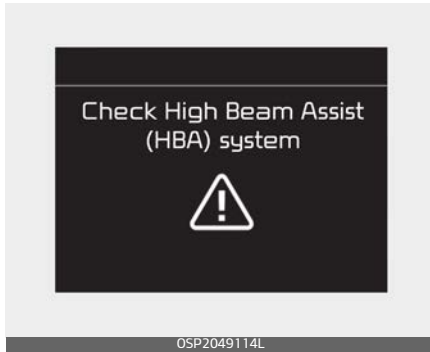

This warning light informs the driver the following situations.

- LED headlamp malfunction (if equipped)
- Lamp malfunction
- High Beam Assist malfunction (if equipped)

At this time, a Master Warning icon (⚠️) will appear beside the User Settings icon (⚙️), on the LCD display.

If the warning situation is resolved, the master warning light will be turned off and the Master Warning icon will disappear.

Transmission temperature gauge (for dual clutch transmission)

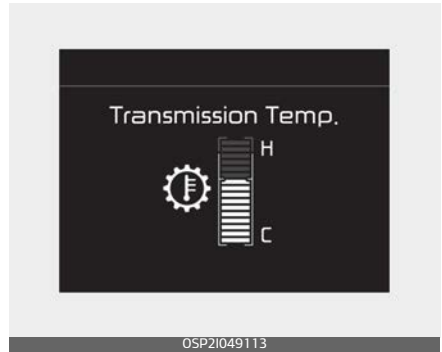

This mode displays the transmission temperature.

User Settings mode

In this mode, you can change the settings of the instrument cluster, doors, lamps, etc.

If your vehicle is equipped with an infotainment system, you can learn how to setup on the website via QR code in the infotainment quick reference guide.

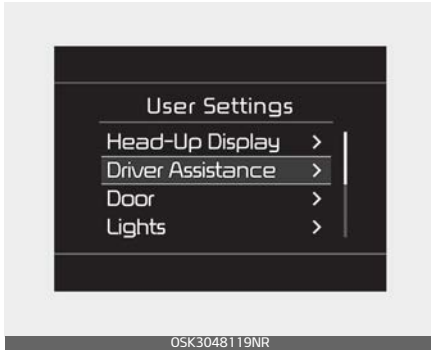

1. Head-Up Display
2. Driver Assistance
3. Door
4. Lights
5. Sound
6. Convenience
7. Service Interval
8. Other features
9. Language
10. Reset

The information provided may differ depending on which functions are applicable to your vehicle.

Shift to P to edit settings

This warning message appears if you try to adjust the User Settings while driving.

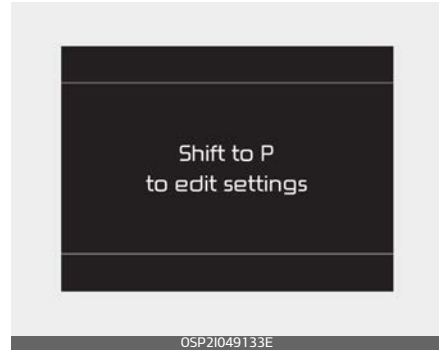

For your safety, change the User Settings after parking the vehicle, applying the parking brake and moving the shift lever to P (Park).

1. Head-Up Display (if equipped)

Items	Explanation
Display Height	Adjust the height (1~20) of the HUD image on the HUD screen.
Rotation	Adjust the degree (-5~+5) of the HUD rotation.
Brightness	Adjust the intensity (1~20) of the HUD brightness.
Speed Size	Small/Medium/Large
Speed Color	White/Orange/Green

2. Driver Assistance (if equipped)

Items	Explanation
Driving Assist	<ul style="list-style-type: none"> • Highway Driving Assist • Highway Auto Curve Zone Slowdown To select the functions.
Warning Timing	<ul style="list-style-type: none"> • Normal/Late To select the Warning time
Warning Volume	<ul style="list-style-type: none"> • High/Medium/Low To select the Warning volume
Driver Attention Warning	<ul style="list-style-type: none"> • Leading Vehicle Departure Alert • Inattentive Driving Warning To select the function. * For more details, refer to the "Driver Attention Warning (DAW) (if equipped)" on page 5-126.
Forward Safety	To adjust Forward Collision-Avoidance Assist. <ul style="list-style-type: none"> • Active Assist / Warning Only / Off To select the functions.
Lane Safety	To adjust Lane Keeping Assist. <ul style="list-style-type: none"> • Lane Keeping Assist / Lane Departure Warning / Off To select the functions.
Blind-Spot Safety	To activate or deactivate Safe Exit Warning. <ul style="list-style-type: none"> • Safe Exit Assist To adjust Blind-Spot Collision-Avoidance Assist. <ul style="list-style-type: none"> • Active Assist / Warning Only / Off

Items	Explanation
Parking Safety	To Activate or deactivate Rear Cross-Traffic Collision-Avoidance Assist. <ul style="list-style-type: none"> • Rear Cross-Traffic Safety To select the functions.

* The information provided may differ depending on which functions are applicable to your vehicle.

3. Door

Items	Explanation
Auto Lock	<ul style="list-style-type: none"> • Off: The auto door unlock operation will be canceled. • Enable on speed: All doors will be automatically locked when the vehicle speed exceeds 9.3 mph (15 km/h) • Enable on shift (if equipped with Automatic transmission): All doors will be automatically locked if the vehicle is shifted from the P (Park) position to the R (Reverse), N (Neutral), or D (Drive) position (with the Engine ON, it is activated.).
Auto Unlock	<ul style="list-style-type: none"> • Off: The auto door unlock operation will be canceled. • Vehicle Off/On key out (if equipped): All doors will be automatically unlocked when the ignition key is removed from the ignition switch or the ENGINE START/STOP button is set to the OFF position. • On shift to P (if equipped with Automatic transmission): All doors will be automatically unlocked if the gear is shifted to the P (Park) position (with the Engine ON, it is activated.).
Two Press Unlock	If this item is checked, the two press unlock will be activated. Press the door unlock button once to unlock the driver's door, and press the button once more within seconds to unlock the rest of the doors.

* The information provided may differ depending on which functions are applicable to your vehicle.

4. Lights

Items	Explanation
One Touch Turn Signal	<ul style="list-style-type: none"> • Off: The one touch turn signal function will be deactivated. • 3, 5, 7 flashes: The turn signal indicator will blink 3, 5, or 7 times when the turn signal lever is moved slightly. <p>* For more details, refer to "Lighting" on page 4-98.</p>
Headlight Delay	If this item is checked, the head lamp delay function will be activated.
High Beam Assist (if equipped)	If this item is checked, High Beam Assist will be activated.

* The information provided may differ depending on which functions are applicable to your vehicle.

5. Convenience

Items	Explanation
Welcome Mirror	<ul style="list-style-type: none"> • On door unlock / On driver approach To select the welcome mirror function.
Wireless Charging System	<ul style="list-style-type: none"> • If this item is checked, the wireless charging function will be activated.
Wiper/Lights Display	<ul style="list-style-type: none"> • If this item is checked, the wiper/lights display will be activated.
Auto Rear Wiper (in R)	<ul style="list-style-type: none"> • If this item is checked, the auto rear wiper will be activated.
Gear Position Pop-up	<ul style="list-style-type: none"> • If this item is checked, gear position pops up on the lower left corner of the LCD on changing the gear.
Icy Road Warning	<ul style="list-style-type: none"> • If this item is checked, the icy road warning will be activated.
Vehicle Auto-Shut Off	<ul style="list-style-type: none"> • 60 min / 30 min: To set the vehicle auto shut-off timer. • Disable: The vehicle auto-shut off operation will be canceled. <p>* For more details, refer to "Vehicle Auto Shut-off system (if equipped)" on page 5-17.</p>
Rear Occupant Alert	<ul style="list-style-type: none"> • To activate or deactivate the Rear Occupant Alert For more details, refer to "Rear Occupant Alert (ROA) system" on page 4-26.

* The information provided may differ depending on which functions are applicable to your vehicle.

6. Service interval

Items	Explanation
Enable Service Interval	If this item is checked, the Service Interval function will be activated.
Adjust Interval	If the service interval menu is activated, you may adjust the time and distance.
Reset	To reset the service interval function.

* NOTICE

To use the service interval menu, consult an authorized Kia dealer.

If the service interval is activated and the time and distance is adjusted, messages are displayed in the following situations each time the vehicle is turned on.

- Service in: Displayed to inform the driver the remaining mileage and days to service.
- Service required: Displayed when the mileage and days to service has been reached or passed.

If any of the following conditions occur, the mileage and number of days to service may be incorrect.

- The battery cable is disconnected.
- The battery is discharged.

7. Other features

Items	Explanation
Fuel Economy Auto Reset	<ul style="list-style-type: none"> Off: The average fuel economy will not reset. After ignition / After refueling: The average fuel economy will reset automatically after ignition/refueling.
Speedometer Unit	<ul style="list-style-type: none"> mph, km/h To select the Speedometer unit.
Fuel Economy Unit	<ul style="list-style-type: none"> US gallon, UK gallon To select the Fuel economy unit. For more details, refer to "Trip information (trip computer)" on page 4-68.
Temperature Unit	<ul style="list-style-type: none"> °F/°C To select the Temperature unit.
Torque Unit	<ul style="list-style-type: none"> N·m, lbf·ft To select the Torque Unit
Tire Pressure Unit	<ul style="list-style-type: none"> psi, kPa, bar To select the Tire Pressure Unit

* The information provided may differ depending on which functions are applicable to your vehicle.

8. Reset

Items	Explanation
Reset	You can reset the menus in the User Settings mode. All menus in the User Settings mode are reset to factory settings, except language and service interval.

9. Language

Items	Explanation
Language	To select language.

LCD displays

LCD displays show the following information to drivers.

- Trip information
- LCD modes
- Warning messages

Trip information (trip computer)

The trip computer is a microcomputer-controlled driver information system that displays information related to driving.

* NOTICE

Some driving information stored in the trip computer resets if the battery is disconnected.

Trip Modes

To change the trip mode, scroll the toggle the switch (∧ / ∨) on the steering wheel.

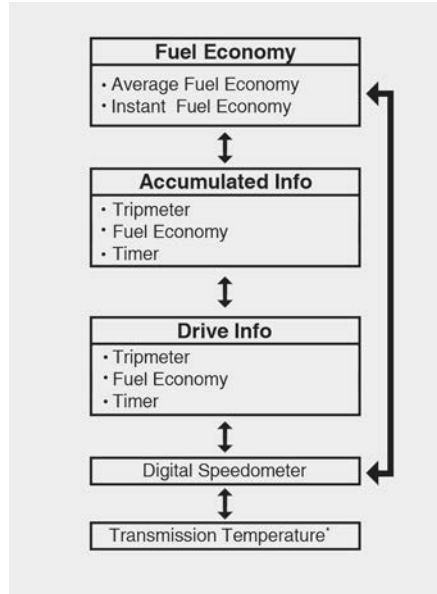

* for vehicle equipped with dual clutch transmission

Fuel Economy

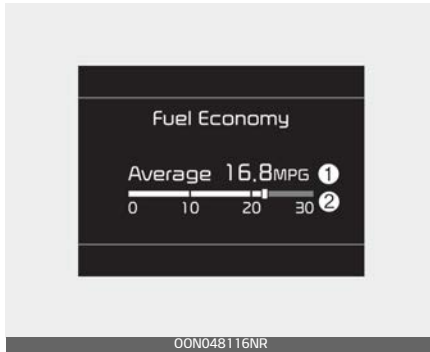

Average Fuel Economy (1)

- The average fuel economy is calculated by the total driving distance and fuel consumption since the last average fuel economy reset.
 - Fuel economy range: 0~99.9 mpg or L/100 km
- The average fuel economy can be reset both manually and automatically.

Manual reset

To clear the average fuel economy manually, press the OK button on the steering wheel for more than 1 second when the average fuel economy is displayed.

Automatic reset

To automatically reset the average fuel economy select either menu from the 'Fuel economy auto reset' in the User Settings mode on the LCD display.

If your vehicle is equipped with an infotainment system, you can learn how to setup on the website via QR

code in the infotainment quick reference guide.

- OFF – You may set to default manually by using the trip switch reset button.
- After ignition – The vehicle will automatically set to default once 4 hours pass after the Ignition is in OFF.
- After refueling – After refueling more than 1.6 gallons (6 liters) and driving over 1 mph (1 km/h), the vehicle will reset to default automatically.

Instant Fuel Economy (2)

- This mode displays the instant fuel economy.

Accumulated Info display

This display shows the accumulated trip distance (1), the average fuel efficiency (2), and the total driving time (3).

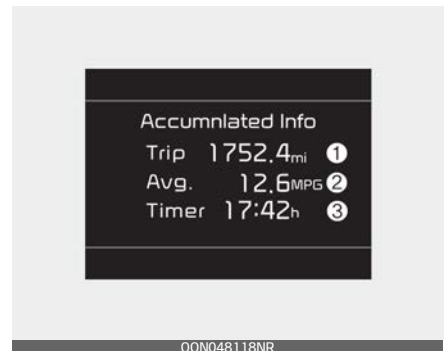

- Accumulated information is calculated after the vehicle has run for more than 0.19 miles (300 meters).
- If you press "OK" button for more than 1 second after the Cumulative Information is displayed, the information will be reset.
- If the engine is running, even when the vehicle is not in motion, the information will be accumulated.

Drive Info display

This display shows the trip distance (1), the average fuel efficiency (2), and the total driving time (3) information once per one ignition cycle.



- Fuel efficiency is calculated after the vehicle has run for more than 0.19 miles (300 meters).
- If you press "OK" button for more than 1 second after the Driving Information is displayed, the information will be reset.
- If the engine is running, even when the vehicle is not in motion,

the information will be accumulated.

*** NOTICE**

The vehicle must be driven for a minimum of 0.19 miles (300 meters) since the last ignition cycle before the average accumulated driving information is recalculated.

Digital speedometer

This digital speedometer display shows the speed of the vehicle.

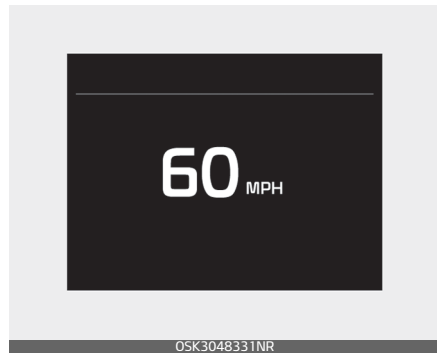

Service Mode

This mode reminds you of scheduled maintenance information.

Service in

It calculates and displays when you need a scheduled maintenance service (mileage or days).

If the remaining mileage or time reaches 900 miles (1,500 km) or 30

days, "Service in" message is displayed for several seconds each time you set the ENGINE START/STOP button to the ON position.

Service required

If you do not have your vehicle serviced according to the already inputted service interval, "Service required" message is displayed for several seconds each time you set the ENGINE START/STOP button to the ON position.

To reset the service interval to the mileage and days that were previously inputted:

- Press the OK button (Reset) for more than 1 second.

*** NOTICE**

If any of the following conditions occurs, the mileage and days may be incorrect.

- The battery cable is disconnected.
- The battery is discharged.

Driving info display

At the end of each driving cycle, the Driving Info message is displayed.



This display shows the trip distance (1), average energy consumption (2), driving time (3).

This information is displayed for a few seconds when you turn off the vehicle, and then goes off automatically. The information is calculated for each time the vehicle is turned on.

*** NOTICE**

- If sunroof open warning is displayed in the cluster, the Driving Information message may not be displayed.

LCD display messages

Engine has overheated

This warning message illuminates when the engine coolant temperature is above 248 °F (120 °C). This means that the engine is overheated and may be damaged.

* If your vehicle is overheated, refer to "If the engine overheats" on page 6–8.

Low Key Battery for smart key system

This warning message illuminates if the battery of the smart key is discharged when the ENGINE START/STOP button changes to the OFF position.

Press START button while turning wheel for smart key system

It means that you should press the ENGINE START/STOP button while turning the steering wheel right and left.

Steering wheel unlocked for smart key system

This warning message illuminates as follows:

- If the steering is not locked when the ENGINE START/STOP button changes to the OFF position.

If the steering wheel lock system has a problem. In this case, have your vehicle inspected by an authorized Kia dealer.

Check Steering Wheel Lock system for smart key system

This warning message illuminates if there is malfunction in steering wheel lock system when the ENGINE START/STOP button changes to the OFF position.

Key not in vehicle for smart key system

This warning message illuminates if the smart key is not in the vehicle when the ENGINE START/STOP button is in the ON position.

It means that you should always have the smart key with you.

Key not detected for smart key system

This warning message illuminates if the smart key is not detected when you press the ENGINE START/STOP button.

Door, hood, liftgate, sunroof open



- This warning is displayed indicating which door, the hood, the liftgate or the sunroof is open.

CAUTION

Before driving the vehicle, you should confirm that the door/hood/liftgate/sunroof is fully closed. Also, check there is no door/hood/liftgate/sunroof open warning light or message displayed on the instrument cluster.

Low Pressure warning display



This warning message is displayed if the tire pressure is low. The corresponding tire on the vehicle will be illuminated.

* For more details, refer to "Tire Pressure Monitoring System (TPMS)" on page 6-10.

Lights mode



This indicator displays which exterior light is selected using the lighting control.

You can activate or deactivate Wiper/Lights Display function from the User Settings mode in the cluster LCD display.

If your vehicle is equipped with an infotainment system, you can learn how to setup on the website via QR code in the infotainment quick reference guide.

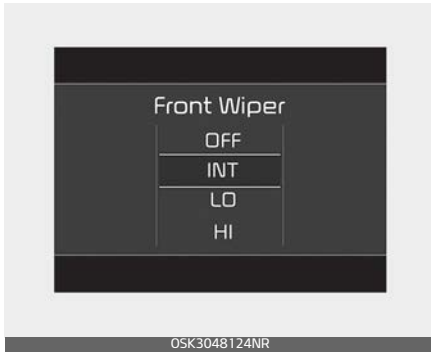
Wiper mode

This indicator displays which wiper speed is selected using the wiper control.

You can activate or deactivate Wiper/Lights Display function from the User Settings mode in the cluster LCD display.

Shift to P or N to start engine for smart key system

This warning message illuminates if you try to start the engine with the shift lever not in the P (Park) or N (Neutral) position.

Press brake pedal to start engine for smart key system

This warning message illuminates if the ENGINE START/STOP button changes to the ACC position twice by pressing the button repeatedly without depressing the brake pedal.

It means that you should depress the brake pedal to start the engine.

Battery discharging due to external electrical devices (if equipped)

The vehicle can detect self-discharge of the battery due to over-current that is generated by unauthorized electrical devices such as dashboard camera (dash cam) mounting during parking.

Please note that functions such as Idle Stop and Go (ISG) are limited and battery discharge problems may occur.

If the warning continues even after external electrical devices are removed, have your vehicle inspected by an authorized Kia dealer.

Press START button again for smart key system

This warning message illuminates if you cannot operate the ENGINE START/STOP button when there is a problem with the ENGINE START/STOP button system.

It means that you could start the engine by pressing the ENGINE START/STOP button once more.

If the warning illuminates each time you press the ENGINE START/STOP button, have the vehicle inspected by an authorized Kia dealer.

Press START button with key for smart key system

This warning message illuminates if you press the ENGINE START/STOP button while the warning message "Key not detected" is illuminating.

At this time, the immobilizer indicator light blinks.

Check DAW (if equipped)

This warning message is displayed if there is a problem with Driver Attention Warning. In this case, have the vehicle inspected by an authorized Kia dealer.

* For more information, refer to "Driver Attention Warning (DAW) (if equipped)" on page 5-126.

Icy Road Warning (if equipped)

This warning is to warn the driver the road may be icy.

When the following conditions occur, the warning light (including outside temperature gauge) blinks 5 times and then illuminates, and also warning chime sounds once.

- The temperature on the outside temperature gauge is below approximately 40 °F (4 °C).

*** NOTICE**

If the icy road warning appears while driving, you should drive more attentively and refrain from speeding, rapid acceleration, sudden braking or sharp turning.

Warning and indicator lights

The warning light and indicator light indicate a situation where the driver should be careful and whether the various functions are activated.

Warning lights

The warning light indicates situations that require the driver to pay attention.

* NOTICE

Warning lights

Make sure that all warning lights are OFF after starting the engine. If any light is still ON, this indicates a situation that needs attention.

Air bag warning light

This warning light illuminates:

- Once you set the ignition switch or ENGINE START/STOP Button to the ON position.
 - It illuminates for approximately 6 seconds and then goes off.
- When there is a malfunction with the Supplemental Restraint System (SRS).

In this case, have the vehicle inspected by an authorized Kia dealer.

Seat belt warning light

This warning light informs the driver that the seat belt is not fastened.

* For more details, refer to "Seat belts" on page 3-19.

Parking brake & brake fluid warning light

This warning light illuminates:

- Once you set the ignition switch or ENGINE START/STOP Button to the ON position.
 - It illuminates for approximately 3 seconds
 - It remains on if the parking brake is applied.
- When the parking brake is applied.
- When the brake fluid level in the reservoir is low.
 - If the warning light illuminates with the parking brake released, it indicates the brake fluid level in reservoir is low.

If the brake fluid level in the reservoir is low:

1. Drive carefully to the nearest safe location and stop your vehicle.
2. With the engine stopped, check the brake fluid level immediately and add fluid as required (For more details, refer to "Brake fluid" on page 7-30). Then check all brake components for fluid leaks.

If any leak on the brake system is still found, the warning light remains on, or the brakes do not operate properly, do not drive the vehicle.

In this case, have your vehicle towed to an authorized Kia dealer and inspected.

Dual-diagonal braking system

Your vehicle is equipped with dual-diagonal braking systems. This means that braking still works for two wheels even if one of the dual systems should fail.

With only one of the dual systems working, greater pedal pressure is required to stop the vehicle.

Also, the vehicle will require increased stopping distance with only a portion of the brake system working.

WARNING

Parking Brake & Brake Fluid Warning Light

Driving the vehicle with a warning light ON is dangerous. If the Parking Brake & Brake Fluid Warning Light illuminates with the parking brake released, it indicates that the brake fluid level is low.

In this case, have your vehicle inspected by an authorized Kia dealer.

Anti-lock brake system (ABS) warning light

This warning light illuminates:

- Once you set the ignition switch or ENGINE START/STOP button to the ON position.
 - It illuminates for approximately 3 seconds and then goes off.
- When there is a malfunction with the ABS (The normal braking system will still be operational without the assistance of the anti-lock brake system).

In this case, have your vehicle inspected by an authorized Kia dealer.

Electronic Power Steering (EPS) warning light

This warning light illuminates:

- Once you set the ignition switch or ENGINE START/STOP Button to the ON position.
 - This indicator light comes on after the ignition key is turned to the ON position and then goes out after approximately 3 seconds.
- When there is a malfunction with the EPS.

In this case, have your vehicle inspected by an authorized Kia dealer.

Charging System Warning Light**This warning light illuminates:**

- Once you set the ignition switch or ENGINE START/STOP button to the ON position.
- When there is a malfunction with either the alternator or electrical charging system.

If there is a malfunction with either the alternator or electrical charging system:

1. Drive carefully to the nearest safe location and stop your vehicle.
2. Turn the engine off and check the alternator drive belt for looseness or breakage.

In this case, have your vehicle inspected by an authorized Kia dealer.

Malfunction Indicator Lamp (MIL)**This warning light illuminates:**

- Once you set the ignition switch or ENGINE START/STOP button to the ON position.
 - It remains on until the engine is started.
- When there is a malfunction with the emission control system. In this case, have the vehicle inspected by an authorized Kia dealer.

⚠ CAUTION**Malfunction Indicator Lamp (MIL)**

Driving with the Malfunction Indicator Lamp (MIL) on may cause damage to the emission control systems which could effect drivability and/or fuel economy.

⚠ CAUTION

If the Malfunction Indicator Lamp (MIL) illuminates, potential catalytic converter damage is possible which could result in loss of engine power. In this case, have the vehicle inspected by an authorized Kia dealer.

Engine oil pressure warning light**This warning light illuminates:**

- Once you set the ignition switch or ENGINE START/STOP Button to the ON position.
 - It remains on until the engine is started.
- When the engine oil pressure is low.
 - Drive carefully to the nearest safe location and stop your vehicle.
 - Turn the engine off and check the engine oil level (For more details, refer to "Engine oil and

filter" on page 7-24). If the level is low, add oil as required.

- If the warning light remains on after adding oil or if oil is not available, have the vehicle inspected by an authorized Kia dealer.

Continued driving with the warning light on may cause engine failure.

- When engine oil pressure decreases due to insufficient engine oil, etc., the Engine Oil Pressure warning light will illuminate.

CAUTION

Engine Overheating

Do not continue driving with the engine overheated. Otherwise, the engine may be damaged.

CAUTION

Engine damage

If the engine is not stopped immediately after the engine oil pressure warning light is illuminated and stays on while the engine is running, serious engine damage may result.

Low Fuel Level Warning Light

This warning light illuminates:

When the fuel tank is nearly empty.

If the fuel tank is nearly empty:

Add fuel as soon as possible.

CAUTION

Low Fuel Level

Driving with the Low Fuel Level warning light on or with the fuel level below "E" can cause the engine to misfire and damage the catalytic converter. (if equipped)

Low Tire Pressure Warning Light



This warning light illuminates:

- Once you set the ignition switch or ENGINE START/STOP button to the ON position.
 - It illuminates for approximately 3 seconds and then goes off.
- When one or more of your tires are significantly under inflated. (The location of the underinflated tires are displayed on the LCD display).

* For more details, refer to "Tire Pressure Monitoring System (TPMS)" on page 6-10.

This warning light remains on after blinking for approximately 60 seconds or repeats blinking on and off at the intervals of approximately 3 seconds:

- When there is a malfunction with the TPMS.
In this case, have your vehicle inspected by an authorized Kia dealer.
- * For more details, refer to "Tire Pressure Monitoring System (TPMS)" on page 6–10.

WARNING

Low tire pressure

- Significantly low tire pressure makes the vehicle unstable and can contribute to loss of vehicle control and increased braking distances.
- Continued driving on low pressure tires will cause the tires to overheat and fail.

WARNING

Safe Stopping

- The TPMS cannot alert you to severe and sudden tire damage caused by external factors.
- If you notice any vehicle instability, immediately take your foot off the accelerator pedal, apply the brakes gradually with light force, and slowly move to a safe position off the road.

Master warning light

This indicator light illuminates:

- This warning light informs the driver the following situations
 - LED headlamp malfunction (if equipped)
 - Lamp malfunction
 - High Beam Assist malfunction (if equipped)
 - Blind Spot Detection malfunction (if equipped)

To identify the details of the warning, look at the LCD display. If the warning situation is solved, the master warning light will turn off.

LED Headlamp Warning Light (if equipped)

This warning light illuminates:

- Once you set the ENGINE START/STOP button to the ON position.
 - It illuminates for approximately 3 seconds and then goes off.
- When there is a malfunction with the LED headlamp.

In this case, have your vehicle inspected by an authorized Kia dealer.

This warning light blinks:

- When there is a malfunction with a LED headlamp related part.

In this case, have your vehicle inspected by an authorized Kia dealer.

CAUTION

LED Headlamp Warning Light

Continuous driving with the LED Headlamp Warning Light on or blinking can reduce LED headlamp (low beam) life.

Forward Collision-Avoidance Assist Warning Light (if equipped)

This indicator light illuminates:

- Once you set the ignition switch or ENGINE START/STOP button to the ON position.
 - It illuminates for approximately 3 seconds and then goes off.
- When Forward Collision-Avoidance Assist is turned off.
- When the radar sensor or cover is blocked with dirt or snow. Check the sensor and cover and clean them by using a soft cloth.
- When there is a malfunction with Forward Collision-Avoidance Assist. If this occurs, have your vehicle inspected by an authorized Kia dealer.

* For more details, refer to "Forward Collision-Avoidance Assist (FCA) (Front view camera only) (if equipped)" on page 5-74.

Electronic Parking Brake (EPB) warning light (if equipped)

This warning light illuminates:

- Once you set the ignition switch or ENGINE START/STOP button to the ON position.
 - It illuminates for approximately 3 seconds and then goes off.
- When there is a malfunction with the EPB.

In this case, you should have the vehicle inspected by an authorized Kia dealer.

* NOTICE

Electronic Parking Brake (EPB) Warning Light

The Electronic Parking Brake (EPB) Warning Light may illuminate when the Electronic Stability Control (ESC) Indicator Light comes on to indicate that the ESC is not working properly (This does not indicate malfunction of the EPB).

Exhaust system (GPF) warning light

This warning light illuminates:

- When there is a malfunction with Gasoline Particulate Filter (GPF) system.

- When this warning light illuminates, it may turn off after driving the vehicle:
 - The vehicle should be driven for more than 30 minutes at a speed of 50 mph (80 km/h) and faster.
 - Ensure the following conditions are all met: safe road conditions, transmission 3rd gear or above, and engine speed of 1,500 - 4,000 rpm.

If this warning light blinks in spite of the procedure (at this time the LCD warning message will be displayed), have the GPF system checked by an authorized Kia dealer.

⚠ CAUTION

Gasoline Engine with GPF

If you continue to drive with the GPF warning light blinking for a long time, the GPF system can be damaged and fuel consumption can worsen.

All Wheel Drive (AWD) warning light



(if equipped)

This warning light illuminates:

- Once you set the ENGINE START/STOP button to the ON position.
 - It illuminates for approximately 3 seconds and then goes off.
- When there is a malfunction with the AWD.

In this case, have your vehicle inspected by an authorized Kia dealer.

Door Ajar Warning Light 

This warning light illuminates:

When a door is not closed securely.

Indicator lights

Electronic stability control (ESC)

indicator light 

This indicator light illuminates:

- Once you set the ignition switch or ENGINE START/STOP Button to the ON position.
 - It illuminates for approximately 3 seconds and then goes off.
- When there is a malfunction with the ESC system.

In this case, have your vehicle inspected by an authorized Kia dealer.

This indicator light blinks:

While the ESC is operating.

* For more details, refer to "Electronic Stability Control (ESC) system" on page 5-58.

Electronic stability control (ESC)**OFF indicator light** **This indicator light illuminates:**

- Once you set the ignition switch or ENGINE START/STOP Button to the ON position.
 - It illuminates for approximately 3 seconds and then goes off.
 - When you deactivate the ESC system by pressing the ESC OFF button.
- * For more details, refer to "Electronic Stability Control (ESC) system" on page 5-58.

Immobilizer Indicator Light (Without Smart Key)  (if equipped)**This indicator light illuminates:**

- When the vehicle detects the immobilizer in your key properly while the ignition switch is ON.
 - At this time, you can start the engine.
 - The indicator light goes off after starting the engine.

This indicator light blinks:

- When there is a malfunction with the immobilizer system.
In this case, have your vehicle inspected by an authorized Kia dealer.

Immobilizer Indicator Light (With Smart Key)  (if equipped)**This indicator light illuminates for up to 30 seconds:**

- When the vehicle detects the smart key in the vehicle properly while the ENGINE START/STOP Button is ACC or ON.
 - At this time, you can start the engine.
 - The indicator light goes off after starting the engine.

This indicator light blinks for a few seconds:

- When the smart key is not in the vehicle.
 - At this time, you can not start the engine.

This indicator light illuminates for 2 seconds and goes off:

- When the vehicle can not detect the smart key which is in the vehicle while the ENGINE START/STOP Button is ON.
In this case, have your vehicle inspected by an authorized Kia dealer.

This indicator light blinks:

- When the battery of the smart key is weak.
 - At this time, you can not start the engine. However, you can start the engine if you press the ENGINE START/STOP But-

ton with the smart key. (For more details, refer to "Folding key immobilizer system (if equipped)" on page 4-15).

- When there is a malfunction with the immobilizer system. In this case, have your vehicle inspected by an authorized Kia dealer.

Auto stop indicator (A)

This indicator will illuminate when the engine enters the Idle Stop mode of the Idle Stop and Go (ISG) system.

When the automatic starting occurs, the auto stop indicator on the cluster will blink for 5 seconds.

* For more details, refer to "Idle Stop and Go (ISG) system" on page 5-67.

*** NOTICE**

When the engine automatically starts by the ISG system, warning lights (ABS, ESC, ESC OFF, EPS or Parking brake warning light) may turn on for a few seconds.

This happens because of the low battery voltage. It does not mean the system is malfunctioning.

Turn signal indicator light 

This indicator light blinks:

- When you turn the turn signal light on.

If any of the following occurs, there may be a malfunction with the turn signal system. In these cases have your vehicle inspected by an authorized Kia dealer.

- The indicator light does not blink but illuminates.
- The indicator light blinks more rapidly.
- The indicator light does not illuminate at all.

Low beam indicator light  (if equipped)

This indicator light illuminates:

- When the headlights are on.

High beam indicator light 

This indicator light illuminates:

- When the headlights are on and in the high beam position.
- When the turn signal lever is pulled into the Flash-to-Pass position.

High Beam Assist indicator  (if equipped)

This warning light illuminates :

- When the high beam is on with the light switch in the AUTO light position.
 - If your vehicle detects oncoming or preceding vehicles, High Beam Assist will switch the high beam to low beam automatically.
- * For more details, refer to "High Beam Assist (HBA) (if equipped)" on page 4-102.

Lane Keeping Assist indicator  (if equipped)

Lane Keeping Assist indicator will illuminate when you turn Lane Keeping Assist on by pressing the Lane Safety button.

If there is a problem with the function, the yellow Lane Keeping Assist indicator will illuminate.

- * For more details, refer to "Lane Keeping Assist (LKA) (if equipped)" on page 5-105.

Light ON indicator light 

This indicator light illuminates:

- When the tail lights or headlights are on.

Front fog indicator light  (if equipped)

This indicator light illuminates:

- When the front fog lights are on.

Cruise indicator light  CRUISE (if equipped)

This indicator light illuminates:

- When Cruise Control is enabled.
- * For more details, refer to "Cruise Control (CC) (if equipped)" on page 5-132.

Downhill Brake Control (DBC) Indicator Light  (if equipped)

This indicator light illuminates:

- When you set the ignition switch or ENGINE START/STOP Button to the ON position.
 - It illuminates for approximately 3 seconds and then goes off.
- When you activate the system by pressing the DBC button.

This indicator light blinks:

- When the DBC is operating.

This indicator light illuminates yellow:

- When there is a malfunction with the DBC system.

If this occurs, have your vehicle inspected by an authorized Kia dealer.

* For more details, refer to "Downhill Brake Control (DBC)" on page 5-64".

All Wheel Drive (AWD) LOCK indicator light  (if equipped)

This indicator light illuminates:

- Once you set the ENGINE START/STOP button to the ON position.
 - It illuminates for approximately 3 seconds and then goes off.
- When you select AWD lock mode by pressing the AWD LOCK button.
 - The AWD lock mode is to increase the drive power when driving on wet pavement, snow covered roads and/or off-road.

*** NOTICE**

AWD Lock Mode

Do not use AWD LOCK mode on dry paved roads or highway, as it can cause noise, vibration or damage of AWD related parts.

Head-Up Display (HUD) (if equipped)

The head up display is a transparent display which projects a shadow of some information of the instrument cluster and navigation on the HUD screen.



1. Combiner
2. Shutter

The hidden screen will go up when you press the screen operation switch on the left side of the lower part of crash pad and if you press the switch again, the screen will return to its original hidden position.



- The head up display image on the HUD screen may be invisible when:
 - Sitting posture is bad.
 - Wearing a polarized sunglasses.
 - There is an object on the cover of the head up display.
 - Driving on a wet road.
 - An inadequate lighting is turned on inside the vehicle.
 - Any light comes from the outside.
 - Wearing an inadequate glasses to your eyesight.
- If the head up display image is not shown well, adjust the height, rotation or illumination of the head up display in the cluster.
- When the head up display needs inspection or repair, have your vehicle inspected or repaired by an authorized Kia dealer.

WARNING

Head-Up Display

- Do not place any accessories on the Head-Up Display shutter. It might fall into Head-Up Display and can damage to Head-Up Display.
- Do not attach stickers or accessories to the Head-Up Display and the crash pad.
- Do not manually adjust the shutter and combiner. The images may not be visible due to fingerprints. Excessive external force during operation may cause damage.
- Do not place any objects near the Head-Up Display. Interference with the object during operation may damage it.
- Do not place any objects around the Head-Up Display. It might enter the narrow gap of the cover and affects operation.
- Do not place any liquids around the Head-Up Display. Water or other liquids can flow into the Head-Up Display and break it.
- Do not expose the combiner to strong light. The combiner may become deformed.
- Do not use organic solvents, detergents or abrasive cloths to clean the Head-Up Display. Wipe it off with a soft cloth. Do not strongly wipe Head-Up Display shutter. It might get damaged.
- For safety, be sure to adjust the settings when the vehicle is stopped.
- When opening, closing and height adjusting the Head-Up Display, noise may be generated by the motor and gear.

Head-Up Display Information

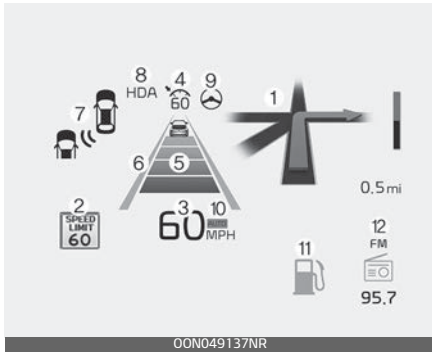

1. Turn By Turn navigation information (if equipped)
2. Road signs (if equipped)
3. Speedometer
4. SCC setting speed (if equipped)
5. SCC Vehicle Distance information (if equipped)
6. Lane Safety information (if equipped)
7. Blind-Spot Safety information (if equipped)
8. Highway Driving Assist information (if equipped)
9. Lane Following Assist information (if equipped)
10. HDA automatic speed control information (if equipped)
11. Warning lights (low fuel)
12. Infotainment system information

Head up Display Setting

On the LCD display, you can change the head up display settings as follows.

1. Display height
2. Rotation
3. Brightness
4. Content selection
5. Speedometer size
6. Speedometer color

* For more details, refer to "LCD Display Modes" on page 4-59.

* NOTICE

Road Signs and Turn By Turn navigation information are available depending on the region.

Rear View Monitor (RVM)

Rear View Monitor is a supplemental function that shows the area behind the vehicle on the Infotainment System screen to assist you when parking or backing up.

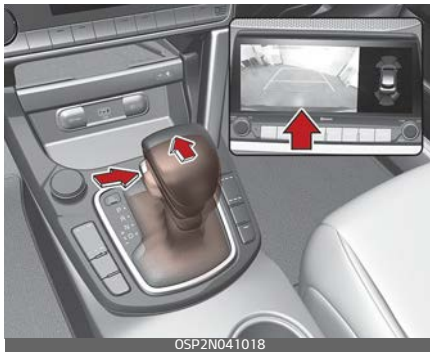

- Rear View Monitor with parking guidance will activate when the engine is running and the shift lever is in the R (Reverse) position.
- To assist in parking, the rear view is shown (the parking guide line disappears) on the screen when the shift lever is moved from R (Reverse) to D (Drive) with vehicle speed below 9 mph (15 km/h).

Rear View Monitor – Top view

Type A



Type B
(if equipped with PDW)



When you touch the icon (1), the top view is displayed on the screen and shows the distance from the vehicle in the back of your vehicle. Touch the icon (1) again, to switch back to the previous screen.

When you touch the icon (2), you can set the screen brightness. (if equipped with the PDW)

⚠ WARNING**Backing & using camera**

Never rely solely on Rear View Monitor. You must always use methods of viewing the area behind you including looking over both shoulders as well as continuously checking all three rear view mirrors. Due to the difficulty of ensuring that the area behind you remains clear, always back up slowly and stop immediately if you suspect that a person, and especially a child, might be behind you.

*** NOTICE**

If the camera lens is covered with foreign material, the Rear View Monitor may not operate normally. Always keep the camera lens clean. However, do not use chemical solvents such as strong detergents containing high alkaline or volatile organic solvents (gasoline, acetone etc.). This may damage the camera lens.

Reverse Parking Distance Warning (PDW) (if equipped)

Reverse Parking Distance Warning assists the driver during reverse movement of the vehicle by chiming if any object is sensed within the distance of 48 in (120 cm) behind the vehicle.



Reverse Parking Distance Warning is a supplemental function that senses objects within the range and location of the sensors (1), it cannot detect objects in other areas where sensors are not installed.

⚠ WARNING

- Always look around your vehicle to make sure there are not any objects or obstacles before moving the vehicle in any direction to prevent a collision.
- Always pay close attention when the vehicle is driven close to objects, particularly pedestrians, and especially children.

- Be aware that some objects may not be visible on the screen or be detected by the sensors, due to the objects distance, size or material, all of which can limit the effectiveness of the sensor.

Operation of Reverse Parking Distance Warning

Operating condition



- Press the Parking Safety button to turn the function on and off.
- Reverse Parking Distance Warning will activate when backing up with the ignition switch in the ON position. However, if vehicle speed exceeds 3 mph (5 km/h), the function may not detect objects.
- If vehicle speed exceeds 3 mph (5 km/h), the function will not warn you even though objects are detected.
- When more than two objects are sensed at the same time, the closest one will be recognized first.

Types of warning sound and indicator

Distance from object (in (cm)) & Type of Warning sound	Warning indicator
When an object is 24-48 in (60-120 cm) from the rear bumper: Buzzer beeps intermittently.	
When an object is 12-24 in (30-60 cm) from the rear bumper: Buzzer beeps more frequently.	
When an object is within 12 in (30 cm) of the rear bumper: Buzzer beeps continuously.	

Non-operational conditions of Reverse Parking Distance Warning

Reverse Parking Distance Warning may not operate properly when:

- Moisture is frozen to the sensor. (It will operate normally once the moisture clears.)
- The sensor is covered with foreign matter, such as snow or water, or the sensor cover is blocked. (It will operate normally when the material is removed or the sensor is no longer blocked.)
- Driving on uneven road surfaces (unpaved roads, gravel, bumps, gradient).
- Objects generating excessive noise (vehicle horns, loud motorcycle engines, or truck air brakes) are within range of the sensor.
- There is rain or water spraying nearby.

- Wireless transmitters or mobile phones are within range of the sensor.
- The sensor is covered with snow.
- Trailer towing

The detecting range may decrease when:

- Outside air temperature is extremely hot or cold.
- Undetectable objects smaller than 40 in (100 cm) and narrower than 6 in (14 cm) in diameter.

The following objects may not be recognized by the sensor:

- Sharp or slim objects such as ropes, chains or small poles.
- Objects, which tend to absorb sensor frequency such as clothes, spongy material or snow.

Reverse Parking Distance Warning precautions

- Reverse Parking Distance Warning may not sound consistently depending on the speed and shapes of the objects detected.
- Reverse Parking Distance Warning may malfunction if the vehicle bumper height or sensor installation has been modified or damaged. Any non-factory installed equipment or accessories may also interfere with the sensor performance.
- The sensor may not recognize objects less than 12 in (30 cm)

from the sensor, or it may sense an incorrect distance. Use caution.

- When the sensor is frozen or stained with snow, dirt, or water, the sensor may be inoperative until the stains are removed using a soft cloth.
- Do not push, scratch or strike the sensor with any hard objects that could damage the surface of the sensor. Sensor damage could occur.
- Do not spray the sensors or its surrounding area directly with a high pressure washer. Shock applied from high pressure water may cause the device to not operate normally.

*** NOTICE**

This function can only sense objects within the range and location of the sensors. It cannot detect objects in other areas where sensors are not installed. Also, small or slim objects, such as poles or objects located between sensors may not be detected by the sensors. Pay close attention when the vehicle is driven close to objects on the road, particularly pedestrians, and especially children. Always visually check behind the vehicle when backing up. Be sure to inform any drivers of the vehicle that may be unfamiliar with

the function regarding the function's capabilities and limitations.

Self-diagnosis

If you don't hear an audible warning sound or if the buzzer sounds intermittently when shifting the gear to the R (Reverse) position, this may indicate a malfunction in Reverse Parking Distance Warning. If this occurs, have your vehicle checked by an authorized Kia dealer as soon as possible.

*** NOTICE**

Your new vehicle warranty does not cover any accidents or damage to the vehicle or injuries to its occupants. Always drive safely and cautiously.

Forward/Reverse Parking Distance Warning (PDW) (if equipped)

Forward/Reverse Parking Distance Warning assists the driver during movement of the vehicle by chiming if any object is sensed within the distance of 40 in (100 cm) in front and 48 in (120 cm) behind the vehicle.

Rear

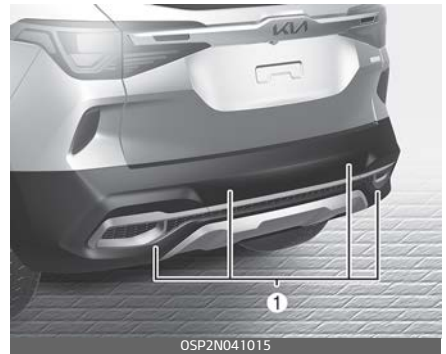

Front



Forward/Reverse Parking Distance Warning is a supplemental function that senses objects within the range and location of the sensors (1), it cannot detect objects in other areas where sensors are not installed.

⚠ WARNING

Forward/Reverse Parking Distance Warning is a supplemental function only.

The operation of Forward/Reverse Parking Distance Warning can be affected by several factors (including environmental conditions).

It is the responsibility of the driver to always check the front and rear views before and while parking.

Operation of the Forward/Reverse Parking Distance Warning







Operating condition



- Forward/Reverse Parking Distance Warning will activate when the Parking Safety button is pressed with the engine running.
- The Parking Safety button turns on automatically and activates the function when the gear is R (Reverse) position. However, if vehicle speed exceeds 6 mph (10 km/h), the function will not warn you even though objects are detected, and if vehicle speed exceeds 12 mph (20 km/h), the function will turn off automatically. To turn on the function, press the Parking Safety button.
- When more than two objects are sensed at the same time, the closest one will be recognized first.

It may not operate if the vehicle's distance from the object is already less than approximately 10 in (25 cm) when the function is activated.

Type of warning indicator and sound

Distance from object in (cm)		Warning indicator		Warning sound
		When driving forward	When driving backward	
24-40 (60-100)	Front		-	Buzzer beeps intermittently
24-48 (60-120)	Rear	-		Buzzer beeps intermittently
12-24 (30-60)	Front			Buzzer beeps frequently
	Rear	-		Buzzer beeps frequently
12 (30)	Front			Buzzer beeps continuously
	Rear	-		Buzzer beeps continuously

- The actual warning sound and indicator may differ from the illustration depending on the objects or sensor status.
- Do not wash the vehicle's sensor with high pressure water.

4

*** NOTICE**

- The indicator may differ from the illustration depending on objects or sensors status. If the indicator blinks, Have the function checked by an authorized Kia dealer.
- If the audible warning does not sound or if the buzzer sounds intermittently when the gear is R (Reverse) position, this may indicate a malfunction with Forward/Reverse Parking Distance Warning. If this occurs, have your vehicle checked by an authorized Kia dealer as soon as possible.

Non-operational conditions of Forward/Reverse Parking Distance Warning**Forward/Reverse Parking Distance Warning may not operate normally when:**

- Moisture is frozen to the sensor. (It will operate normally when moisture melts.)
- Sensor is covered with foreign matter, such as snow or water, or the sensor cover is blocked. (It will operate normally when the material is removed or the sensor is no longer blocked.)
- Sensor is stained with foreign matter such as snow or water. (Sensing range will return to normal when removed.)

- The parking assist button is off.

There is a possibility of Forward/Reverse Parking Distance Warning malfunction when:

- Driving on uneven road surfaces such as unpaved roads, gravel, bumps, or gradient.
- Objects generating excessive noise such as vehicle horns, loud motorcycle engines, or truck air brakes can interfere with the sensor.
- Heavy rain or water spray.
- Wireless transmitters or mobile phones present near the sensor.
- Sensor is covered with snow.

Detecting range may decrease when:

- Outside air temperature is extremely hot or cold.

The following objects may not be recognized by the sensor:

- Sharp or slim objects such as ropes, chains or small poles.
- Objects, which tend to absorb sensor frequency such as clothes, spongy material or snow.
- There are undetectable objects smaller than 40 in (100 cm) and narrower than 6 in (14 cm) in diameter.

*** NOTICE**

1. The warning may not sound consistently depending on the speed and shapes of the objects detected.
 2. Forward/Reverse Parking Distance Warning may malfunction if the vehicle bumper height or sensor installation has been modified. Any non-factory installed equipment or accessories may also interfere with the sensor performance.
 3. Sensor may not recognize objects less than 12 in (30 cm) from the sensor, or it may sense an incorrect distance. Use with caution.
 4. When the sensor is frozen or stained with snow or water, the sensor may be inoperative until the stains are removed using a soft cloth.
 5. Do not push, scratch or strike the sensor with any hard objects that could damage the surface of the sensor. Sensor damage could occur.
-

*** NOTICE**

This function can only sense objects within the range and location of the sensors; it cannot detect objects in other areas where sensors are not installed. Also, small or slim objects, or objects located between sensors may not be detected.

Always visually check in front and behind the vehicle when driving. Be sure to inform any drivers in the vehicle that may be unfamiliar with the function regarding the function's capabilities and limitations.

*** NOTICE**

Pay close attention when the vehicle is driven close to objects on the road, particularly pedestrians, and especially children. Be aware that some objects may not be detected by the sensors, due to the objects distance, size or material, all of which can limit the effectiveness of the sensor. Always perform a visual inspection to make sure the vehicle is clear of all obstructions before moving the vehicle in any direction.

Self-diagnosis

When you shift the gear to the R (Reverse) position and if one or more of the below occurs, you may have a malfunction in the Forward/Reverse Parking Distance Warning.

- You don't hear an audible warning sound or if the buzzer sounds intermittently.
-  (blinks) is displayed.

If this occurs, have your vehicle checked by an authorized Kia dealer as soon as possible.

* NOTICE

Your new vehicle warranty does not cover any accidents or damage to the vehicle or injuries to its occupants. Always drive safely and cautiously.

Lighting

This vehicle is equipped with a variety of lights to illuminate the interior and exterior of the vehicle.

⚠ CAUTION

To prevent the battery from being discharged, do not leave the headlight and interior light on for a prolonged period of time while the engine is not running.

Battery saver function

The purpose of this feature is to prevent the battery from being discharged if the lights are left in the ON position. The system automatically shuts off the parking lights after the engine is off and the driver's door is opened.

However, the position lamps stay ON even when the driver-side door is opened if the light switch is operated after the engine is turned off.

If necessary, to keep the lamps on turn the position lamps OFF and ON again using the headlamp switch on the steering column after the engine is turned off.

Daytime Running Light (DRL) (if equipped)

The Daytime Running Light (DRL) can make it easier for others to see the front of your vehicle during the day.

The DRL can be helpful in many different driving conditions, and it is especially helpful after dawn and before sunset.

The DRL will turn the dedicated lamp OFF when:

- The headlight switch is on.
- The vehicle is off.
- The front fog light is on.
- Engaging the Parking Brake.

Lighting control

The light switch has a headlight and a position lamp position.



To operate the lights, turn the knob at the end of the control lever to one of the following positions:

1. OFF position / DRL off position.
2. Auto light position
3. Position & Tail lamp

4. Headlight position

Position & Tail lamp



When the light switch is in the position lamp position, the tail, license and instrument panel lights will turn ON.

Head light (Low Beam)



When the light switch is in the head light position, head light (low beam), tail, license light will turn ON.

* NOTICE

The ENGINE START/STOP button must be in the ON position to turn on the headlights.

Auto light

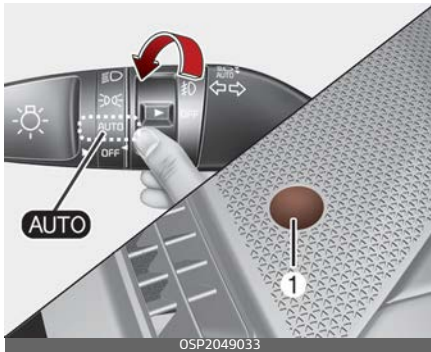

When the light switch is in the AUTO light position, the taillights and headlights will turn ON or OFF automatically depending on the amount of light outside the vehicle.

⚠ CAUTION

- Never place anything over the sensor (1) located on the instrument panel as this will ensure better auto-light system control.
- Don't clean the sensor using a window cleaner, the cleaner may leave a light film which could interfere with sensor operation.
- If your vehicle has window tint or other types of metallic coating on the front windshield, the Auto

light system may not work properly.

Operating high beam

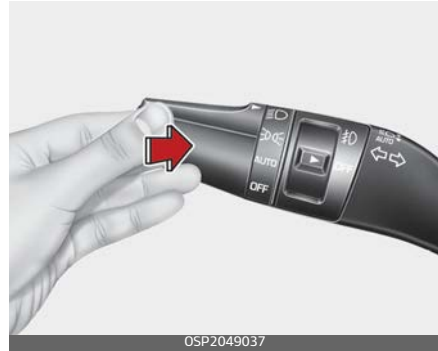

To turn on the high beam headlamp:

- Push the lever away from you. The lever will return to its original position. The high beam indicator will light when the headlight high beams are switched on.

⚠ WARNING

High beams

Do not use high beam when there are other vehicles in front of or approaching your vehicle. Using high beam could obstruct the other driver's vision.

To flash the headlights:

- Pull the lever towards you.



It will return to the normal (low beam) position when released. The headlight switch does not need to be on to use this flashing feature.

Operating turn signals and lane change signals

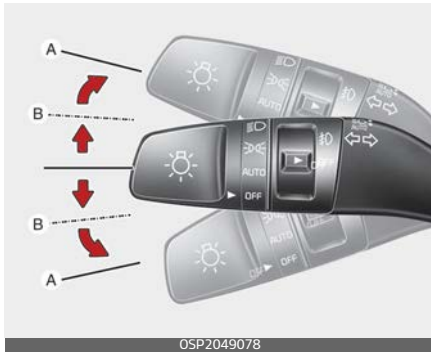

The ENGINE START/STOP button must be on for the turn signals to function.

To turn on the turn signals:

- Move the lever up or down (A). The green arrow indicators on the instrument panel indicate which turn signal is operating. They will self-cancel after a turn is completed. If the indicator continues to flash after a turn, manually return the lever to the OFF position.

To signal a lane change:

- Move the turn signal lever slightly and hold it in position (B). The lever will return to the OFF position when released.

If an indicator stays on and does not flash or if it flashes abnormally, one of the turn signal bulbs may be burned out and will require replacement.

* NOTICE

If an indicator flash is abnormally quick or slow, a bulb may be burned out or have a poor electrical connection in the circuit. The bulb may require replacement.

One-touch lane change function

To activate a one-touch lane change function, move the turn signal lever slightly and then release it. The lane change signals will blink 3, 5 or 7 times.

You can activate or deactivate the One Touch Turn Signal function or choose the number of blinking (3, 5, or 7) by selecting "User Settings → Lights → One Touch Turn signal".

If your vehicle is equipped with an infotainment system, you can learn how to setup on the website via QR code in the infotainment quick reference guide.

*** NOTICE**

If the turn signal indicator stays on and does not flash, or if it flashes abnormally, a bulb may be burned out or have a poor electrical connection in the circuit. The bulb may require replacement.

Operating front fog light \neq (if equipped)

Fog lights are designed to provide improved visibility when visibility is poor due to fog, rain or snow, etc.



The fog lights will turn on when the fog light switch (1) is turned to the on position after the headlight is turned on.

To turn off the fog lights:

- Turn the fog light switch (1) to the ON position.

High Beam Assist (HBA) (if equipped)

High Beam Assist is a function that automatically adjusts the headlamp range (switches between high beam and low beam) according to the brightness of other vehicles and road conditions.



Function setting

The driver can activate High Beam Assist by placing the ignition switch to the ON position and by selecting: 'User Settings → Lights → High Beam Assist'. If you disable this setting, High Beam Assist will not work.

If your vehicle is equipped with an infotainment system, you can learn how to setup on the website via QR code in the infotainment quick reference guide.

The setting of High Beam Assist will be maintained, as selected, when the engine is re-started.

Operating High Beam Assist

High Beam Assist can be operated using the light switch.

1. Place the light switch in the AUTO position.
2. Turn on the high beam by pushing the lever away from you.
3. The High Beam Assist () indicator will illuminate.
4. High Beam Assist will turn on when vehicle speed is above 25 mph (40 km/h).

The details of operation with the light switch while High Beam Assist is on are below.

- If the light switch is pushed away, High Beam Assist will turn off and the high beam will be on continuously.
- If the light switch is pulled towards you when the high beam is off, the high beam will be on without canceling the operation of High Beam Assist. (When you take your hands off the switch, the lever will move to the middle and the high beam will turn off.)

- If the light switch is pulled towards you when the high beam is turned on using High Beam Assist, the low beam will turn on and High Beam Assist turn off.
- If the light switch is turned to the headlamp position () from AUTO position, High Beam Assist will turn off and the low beam will be on continuously.

When High Beam Assist is operating, the high beam switches to low beam in the following conditions.

- When the headlamp is detected from the on-coming vehicle.
- When the tail lamp is detected from the front vehicle.
- When headlamp / tail lamp of bicycle/motorcycle is detected.
- When the surrounding is so bright that high beams are not needed.
- When streetlights or other lights are detected.
- When the light switch is not in the AUTO position.
- When High Beam Assist is off.
- When vehicle speed is below 15 mph (24 km/h).

High Beam Assist warning light and message

When High Beam Assist is not working properly, a warning message "Check High Beam Assist (HBA) system" will come on for a few seconds.

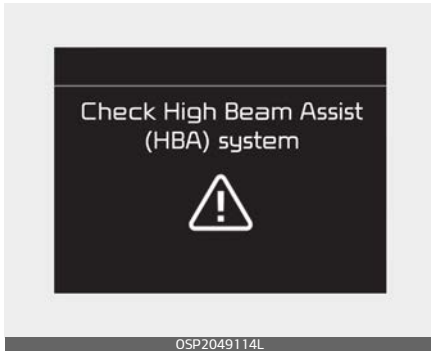

After the message disappears, the master warning light (⚠) will illuminate. Take your vehicle to an authorized Kia dealer and have the function checked.

⚠ CAUTION

High Beam Assist may not work properly in the following situations:

- When the light from an on-coming or front vehicle is poor
 - When the light from an on-coming or front vehicle is not detected because of lamp damage, or because it is hidden from sight, etc.
 - When the lamp of an on-coming or front vehicle is covered with dust, snow or water.
- When a front vehicle's headlamps are off but the fog lamps on, etc.
- When external conditions intervene
 - When there is a lamp that has a similar shape as a front vehicle's lamps.
 - When the headlamp is not repaired or replaced at an authorized Kia dealer.
 - When headlamp aiming is not properly adjusted.
 - When driving on a narrow curved road, rough road, downhill or uphill.
 - When only part of the vehicle in front is visible on a crossroad or curved road.
 - When there is a traffic light, reflecting sign, flashing sign or mirror ahead.
 - When there is a temporary reflector or flash ahead (construction area).
 - When the road conditions are poor such as being wet, iced or covered with snow.
 - When a vehicle suddenly appears from a curve.
 - When the vehicle is tilted from a flat tire or being towed.
 - When Lane Keeping Assist failure indicator (yellow) illuminates.
- When front visibility is poor

- When the lamp of an on-coming or front vehicle is covered with dust, snow or water.
 - When the light from an on-coming or front vehicle is not detected because of exhaust fume, smoke, fog, snow, etc.
 - When the front window is covered with foreign substance.
 - When it is hard to see because of fog, heavy rain or snow, etc.
-
- At times, High Beam Assist may not operate due to function limitations. The function is for your convenience only. It is the responsibility of the driver to drive safely and always check the road conditions.
 - When the function does not operate normally, change the lamp position manually between the high beam and low beam.
-

* NOTICE

- Do not disassemble a front view camera temporarily for tinted window or attaching any types of coatings and accessories. If you disassemble the camera and assemble it again, take your vehicle to an authorized Kia dealer and have the function checked.
- When you replace or reinstall the windshield glass, take your vehicle to an authorized Kia dealer and have the function checked.
- Be careful that water doesn't get into the High Beam Assist unit and do not remove or damage parts of the High Beam Assist.
- Do not place objects on the dashboard that reflect light such as mirrors, white paper, etc. The function may not be able to function if sunlight is reflected onto it.

Wipers and washers

The wipers and washers remove foreign substances from the windshield and rear window, helping to maintain visibility.

Front windshield wiper/washer

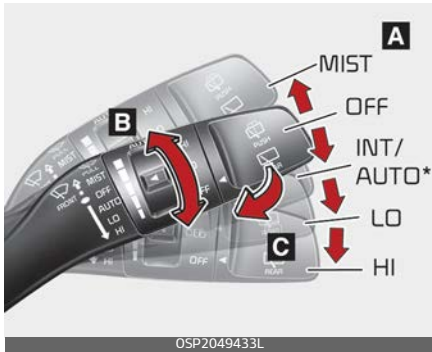

OSP2049433L

Rear windshield wiper/washer



OSP2049434L

A: Wiper speed control (front)

- MIST – Single wipe
- OFF – Off
- INT – Intermittent wipe
- AUTO* – Auto control wipe
- LO – Low wiper speed
- HI – High wiper speed

B: Intermittent control wipe time adjustment

C: Wash with brief wipes (front)

D: Rear wiper/washer control

- HI – Continuous wipe
- LO – Intermittent wipe
- OFF – Off

E: Wash with brief wipes (rear)

* if equipped

Windshield washers

Operates as follows when the ENGINE START/STOP button is turned ON.

MIST: For a single wiping cycle, move the lever to this (MIST) position and release it. The wipers will operate continuously if the lever is held in this position.

OFF: Wiper is not in operation

INT: Wiper operates intermittently at the same wiping intervals. Use this mode in light rain or mist. To vary the speed setting, turn the speed control switch.

AUTO: The rain sensor located on the upper end of the windshield glass senses the amount of rainfall and controls the wiping cycle for the proper interval. The more it rains, the faster the wiper operates. When the rain stops, the wiper stops. To vary the speed setting, turn the speed control knob (B).

LO: Normal wiper speed

HI: Fast wiper speed

* NOTICE

If there is heavy accumulation of snow or ice on the windshield, defrost the windshield for about 10 minutes, or until the snow and/or ice is removed before using the windshield wipers to ensure proper operation. If you do not remove the snow and/or ice before using the wiper and washer, it may damage the wiper and washer system.

⚠ WARNING

Do not use the washer in freezing temperatures without first warming the windshield with the defrosters; the washer solution could freeze on the windshield and obscure your vision.

Auto control (if equipped)

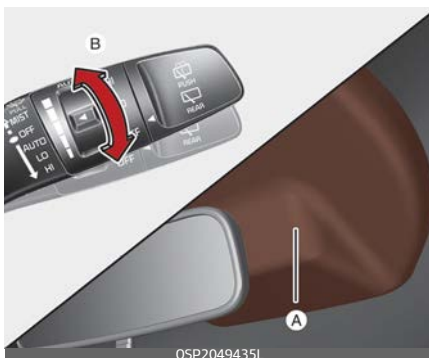

The rain sensor (A) located on the upper end of the windshield glass senses the amount of rainfall and controls the wiping cycle for the proper interval. The more it rains, the faster the wiper operates. When the rain stops, the wiper stops.

To vary the speed setting, turn the speed control knob (B).

If the wiper switch is set in AUTO mode when the ignition switch is ON, the wiper will operate once to perform a self-check of the system. Set the wiper to OFF position when the wiper is not in use.

⚠ WARNING

When the ENGINE START/STOP button is in the ON position and the windshield wiper switch is placed in AUTO mode, use caution in the following situations to avoid any injury to the hands or other parts of the body:

- Do not touch the upper end of the windshield glass facing the rain sensor.
- Do not wipe the upper end of the windshield glass with a damp or wet cloth.
- Do not put pressure on the windshield glass.

⚠ CAUTION

- When washing the vehicle, set the wiper switch in the OFF position to stop the auto wiper operation. The wiper may operate and be damaged if the switch is set in AUTO mode while washing the vehicle.
- Do not remove the sensor cover located on the upper end of the passenger side windshield glass. Damage to system parts could occur and may not be covered by your vehicle warranty.
- When starting the vehicle in winter, set the wiper switch in the OFF position. Otherwise, wipers may operate and ice may damage the windshield wiper blades. Always remove all snow and ice and defrost the windshield properly prior to operating the windshield wipers.

Operating windshield washers

1. Move the wiper speed control switch to In OFF position.
2. Pull the lever gently toward you to spray washer fluid on the windshield and to run the wipers 1–3 cycles. Use this function when the windshield is dirty. The spray and wiper operation will continue until you release the lever.

If the washer does not work, check the washer fluid level. If the fluid level is not sufficient, you will need to add appropriate non-abrasive windshield washer fluid to the washer reservoir.

The reservoir filler neck is located in the front of the engine compartment on the passenger side.

⚠ CAUTION**Washer pump**

To prevent possible damage to the washer pump, do not operate the washer when the fluid reservoir is empty.

⚠ CAUTION**Wipers & windshields**

- To prevent possible damage to the wipers or windshield, do not operate the wipers when the windshield is dry.
- To prevent damage to the wiper blades, do not use gasoline, kero-

- sene, paint thinner, or other solvents on or near them.
- To prevent damage to the wiper arms and other components, do not attempt to move the wipers manually.

Operating rear window wiper and washer switch

The rear window wiper and washer switch is located at the end of the wiper and washer switch lever.

- Turn the switch to the desired position to operate the rear wiper and washer.

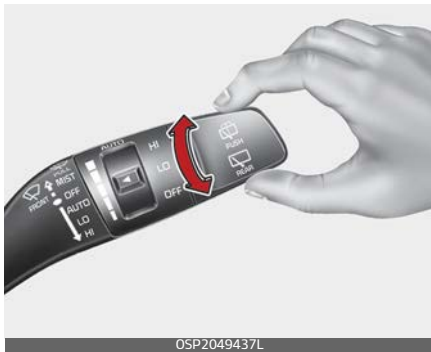

- HI - Normal wiper operation
- LO - Intermittent wiper operation
- OFF - Wiper is not in operation

- Push the lever away from you to spray rear washer fluid and to run the rear wipers 1~3 cycles.



The spray and wiper operation will continue until you release the lever.

Auto rear wiper

The rear wiper will operate while the vehicle is in reverse with the front wiper ON by selecting the function on the LCD display.

Go to 'User Settings → Convenience → Auto Rear Wiper (in R)'.

If your vehicle is equipped with an infotainment system, you can learn how to setup on the website via QR code in the infotainment quick reference guide.

Interior lights

This vehicle is equipped with lights throughout the vehicle to illuminate the interior.

Automatic turn off function (if equipped)

The interior lights automatically turn off approximately 20 minutes after the ENGINE START/STOP button is turned off, if the lights are in the ON position.

If your vehicle is equipped with the theft alarm system, the interior lights automatically turn off approximately 5 seconds after the system is armed.

Map lamp

Type A



Type B



- Touch the position (1) to turn on the map lamp. (Type A)
- Press the position (1) to turn on the map lamp. (Type B)
- To turn the map lamp OFF press the lens (1) again.
-  (2): DOOR mode
 - The map lamp and room lamp come on when a door is opened. The lamps go out after approximately 30 seconds.
 - The map lamp and room lamp come on for approximately 30 seconds when doors are unlocked with a smart key as long as the doors are not opened.
 - The map lamp and room lamp will stay on for approximately 20 minutes if a door is opened with the ENGINE START/STOP button in the ACC or OFF position.
 - The map lamp and room lamp will stay on continuously if the door is opened with the ENGINE

START/STOP button in the ON position.

- The map lamp and room lamp will go out immediately if the ENGINE START/STOP button is changed to the ON position or all doors are locked.
- To turn off the DOOR mode, press the DOOR button (2) once again (not pressed).
-  (3): Press this switch to turn the front and rear room lamps on and off.

*** NOTICE**

The DOOR mode and ROOM mode can not be selected at the same time.

Room lamp

Type A



Type B



Press the switch to turn the room lamp on and off.

Luggage room lamp



The luggage room lamp comes on when the liftgate is opened.

⚠ CAUTION

The luggage room lamp comes on as long as the liftgate opens. To prevent unnecessary charging system drain, close the liftgate securely after using the luggage room.

Vanity mirror lamp (if equipped)



Push the switch to turn the light on or off.

- ☞: The lamp will turn on if this button is pressed.
- ○: The lamp will turn off if this button is pressed.

⚠ CAUTION

Vanity mirror lamp

Always close the lid of the vanity mirror in the off position when the vanity mirror lamp is not in use. If the sun visor is closed without the lamp off, it may discharge the battery or damage the sun visor.

Glove box lamp (if equipped)

The glove box lamp comes on when the glove box is opened.



⚠ CAUTION

To prevent unnecessary charging system drain, close the glove box securely after using the glove box.

Welcome system (if equipped)

The welcome system is a function that illuminates the surroundings or the interior when the driver approaches or exits the vehicle.

Headlight (headlamp) escort function

The headlights (and/or taillights) remain on for approximately 5 minutes after the vehicle is turned off. However, if the driver's door is opened and closed, the headlights are turned off after 15 seconds.

The headlights can be turned off by pressing the lock button on the smart key twice or turning off the light switch from the headlight or Auto light position.

Interior light

When the interior light switch is in the DOOR position and all doors (and liftgate) are locked and closed, the room lamp will come on for 30 seconds if any of the following occurs:

- With the smart key system
 - When the door unlock button is pressed on the smart key.
 - When the button of the outside door handle is pressed.

At this time, if you press the door lock button, the lamps will turn off immediately.

Climate control system



The climate control system uses cooling and heating to help maintain a pleasant environment inside the vehicle.

System operation

Ventilation

1. Set the mode to the  position.
2. Set the air intake control to the outside (fresh) air position.
3. Set the temperature control to the desired position.
4. Set the fan speed control to the desired speed.

Heating

1. Set the mode to the  position.
2. Set the air intake control to the outside (fresh) air position.
3. Set the temperature control to the desired position.
4. Set the fan speed control to the desired speed.
5. If dehumidified heating is desired, turn the air conditioning system on.
 - If the windshield fogs up, set the mode to the  or  position.

Operation tips

- To keep dust or unpleasant fumes from entering the vehicle through the ventilation system, temporarily set the air intake control to the recirculated air position. Be sure to return the control to the fresh air position when the irritation has passed to keep fresh air in the vehicle. This will help keep the driver alert and comfortable.
- Air for the heating/cooling system is drawn in through the grilles just at the base of the windshield. Care should be taken that these are not blocked by leaves, snow, ice or other obstructions.
- To prevent fog from forming on the inside of the windshield:
 - Set the air intake control to the fresh air position and the fan speed to the desired position.
 - Turn on the air conditioning system, and adjust the temperature control to desired temperature.

Air conditioning

Kia Air Conditioning Systems are filled with environmentally friendly refrigerant*.

1. Start the engine. Push the air conditioning button.
2. Set the mode to the  position.
3. Set the air intake control to the outside air or recirculated air position.

4. Adjust the fan speed control and temperature control to maintain maximum comfort.

* : Your vehicle is filled with -1234yf according to the regulation in your country at the time of producing. You can find out which air conditioning refrigerant is applied your vehicle at the label inside of engine room. Refer to "Refrigerant label" on page 8-11 for more detail location of air conditioning refrigerant label.

⚠ CAUTION

- The refrigerant system should only be serviced by trained and certified technicians to insure proper and safe operation.
- The refrigerant system should be serviced in a well-ventilated place.
- The air conditioning evaporator (cooling coil) shall never be repaired or replaced with one removed from a used or salvaged vehicle and new replacement MAC evaporators shall be certified (and labeled) as meeting SAE Standard J2842.

* NOTICE

- When using the air conditioning system, monitor the temperature gauge closely while driving up hills or in heavy traffic when outside

temperatures are high. Air conditioning system operation may cause engine overheating. Continue to use the blower fan but turn the air conditioning system off if the temperature gauge indicates engine overheating.

- When opening the windows in humid weather air conditioning may create water droplets inside the vehicle. Since excessive water droplets may cause damage to electrical equipment, air conditioning should only be used with the windows closed.

Air conditioning system operation tips

- If the vehicle has been parked in direct sunlight during hot weather, open the windows for a short time to let the hot air inside the vehicle escape.
- To help reduce moisture inside of the windows on rainy or humid days, decrease the humidity inside the vehicle by operating the air conditioning system.
- During air conditioning system operation, you may occasionally notice a slight change in engine speed as the air conditioning compressor cycles. This is a normal system operation characteristic.
- Use the air conditioning system every month only for a few min-

utes to ensure maximum system performance.

- When using the air conditioning system, you may notice clear water dripping (or even puddling) on the ground under the passenger side of the vehicle. This is a normal system operation characteristic.
- Operating the air conditioning system in the recirculated air position provides maximum cooling, however, continual operation in this mode may cause the air inside the vehicle to become stale.
- During cooling operation, you may occasionally notice a misty air flow because of rapid cooling and humid air intake. This is a normal system operation characteristic.

Climate control air filter

The climate control air filter installed behind the glove box filters the dust or other pollutants that come into the vehicle from the outside through the heating and air conditioning system.

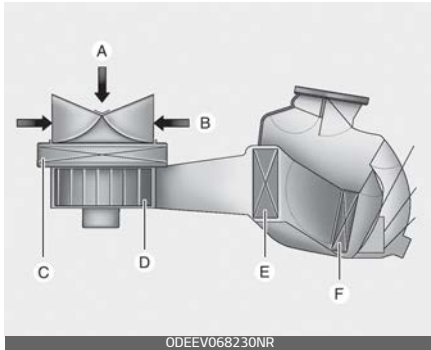

A: Outside air

B: Recirculated air

C: Climate control air filter

D: Blower

E: Evaporator core

F: Heater core

If dust or other pollutants accumulate in the filter over a period of time, the air flow from the air vents may decrease. This leads to moisture accumulating on the inside of the windshield even when the outside (fresh) air position is selected. If this happens, have the climate control air filter replaced by an authorized Kia dealer.

*** NOTICE**

- Replace the filter according to the Maintenance Schedule. If the vehicle is being driven in severe conditions, such as dusty or rough roads, more frequent air condi-

tioner filter inspections and changes are required.

- When the air flow rate suddenly decreases, the system should be checked at an authorized Kia dealer.

Checking the amount of air conditioner refrigerant and compressor lubricant

When the amount of refrigerant is low, the performance of the air conditioning is reduced. Overfilling also has a negative impact on the air conditioning system.

Therefore, if abnormal operation is found, have the system inspected by an authorized Kia dealer.

⚠ WARNING

The oil and refrigerant in your vehicle's air conditioning system is under very high pressure. If proper service procedures are not followed, an explosion may result. To reduce the risk of serious injury or death, the air conditioning system in your vehicle should only be serviced by trained and certified technicians.

⚠ CAUTION

It is important that the correct type and amount of oil and refrigerant is used, otherwise damage to the vehicle may occur. To prevent dam-

age, the air conditioning system in your vehicle should only be serviced by trained and certified technicians.

⚠ WARNING

Vehicles equipped with R-1234yf



Since the refrigerant is mildly flammable and operated at high pressure, the air conditioning system should only be serviced by trained and certified technicians. (Refer to the SAE J2845)

It is important that the correct type and amount of oil and refrigerant are used.

All refrigerants should be reclaimed with proper equipment. Venting refrigerants directly to the atmosphere is harmful to individuals and environment.

Failure to heed these warnings can lead to serious injuries.

Air conditioning refrigerant label

Example



* The actual air conditioning refrigerant label in the vehicle may differ from the illustration.

Each symbol and specification on the air conditioning refrigerant label is represented below:

1. Classification of refrigerant
2. Amount of refrigerant
3. Classification of Compressor lubricant
4. Caution
5. Flammable Refrigerant
6. To requires Registered Technician to Service Air Conditioning system

You can find out which air conditioning refrigerant is applied your vehicle at the label inside of the engine compartment.

Refer to "Refrigerant label" on page 8-11 for more detail on the location of air conditioning refrigerant label.

Manual climate control system

The manual climate control system uses cooling and heating to help maintain a pleasant environment inside the vehicle.





- 1. Fan speed control knob
- 2. Air intake control button
- 3. Mode selection knob
- 4. Rear window defroster (if equipped)
- 5. Temperature control knob
- 6. Air conditioning (A/C) button

⚠ CAUTION

Operating the blower when the ignition switch is in the ON position could cause the battery to discharge. Operate the blower when the engine is running.

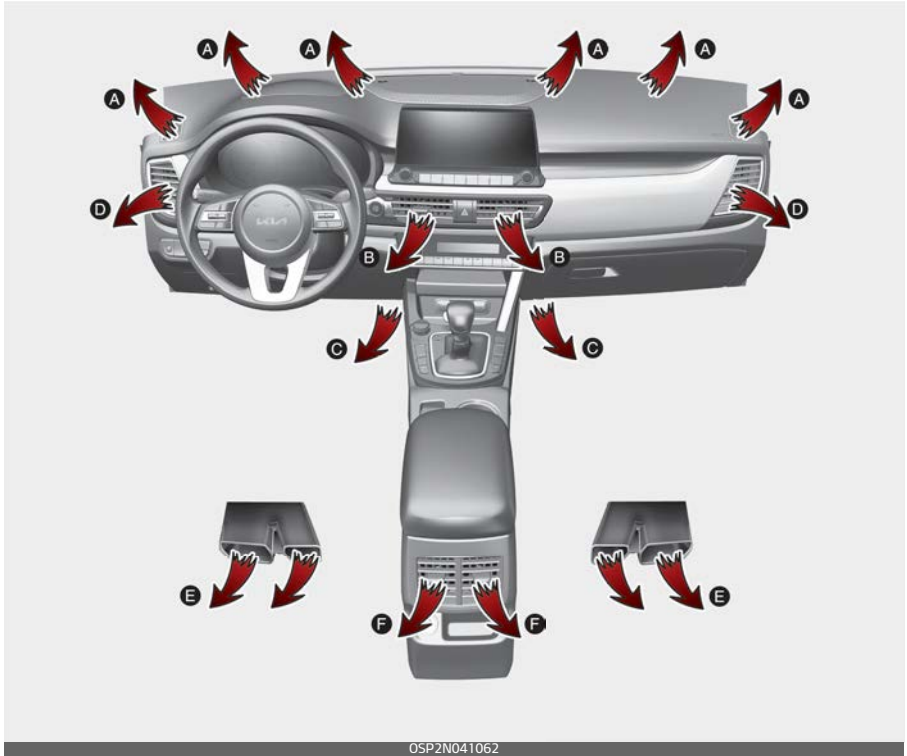
Heating and air conditioning



1. Start the engine.
2. Set the mode to the desired position.
For improving the effectiveness of heating and cooling;
 - Heating: 
 - Cooling: 
3. Set the temperature control to the desired position.
4. Set the air intake control to the outside (fresh) air position.
5. Set the fan speed control to the desired speed.
If air conditioning is desired, turn the air conditioning system on.

Mode selection

The mode selection buttons control the direction of the air flow through the ventilation system.



Air can be directed to the floor, dashboard outlets, or windshield. Five symbols are used to represent Face, Bi-Level, Floor, Floor-Defrost and Defrost air position.

Face-Level (B, D, F)

Air flow is directed toward the upper body and face. Additionally, each outlet can be controlled to direct the air discharged from the outlet.

Bi-Level (B, C, D, E, F)

Air flow is directed towards the face and the floor.

Floor-Level (A, C, D, E, F)

Most of the air flow is directed to the floor, with a small amount of the air being directed to the wind-

shield, side window defrosters and side air vents.

Floor/Defrost-Level (A, C, D, E, F)

Most of the air flow is directed to the floor and the windshield with a small amount directed to the side window defrosters and side air vents.

Defrost-Level (A, D)

Most of the air flow is directed to the windshield with a small amount of air directed to the side window defrosters and side air vents.

Instrument panel vents

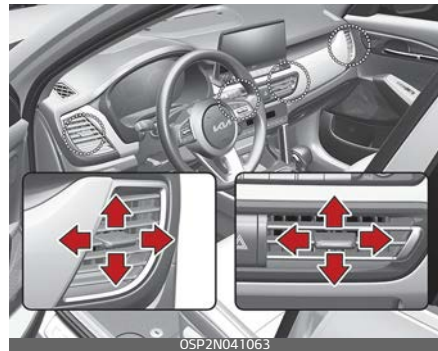

You can adjust the direction of air delivered from these vents using the vent control lever as shown.

Temperature control

The temperature control knob allows you to control the temperature of the air flowing from the ventilation system.



To change the air temperature in the passenger compartment, turn the knob to the right for warm and hot air or to the left for cooler air.

* NOTICE

When starting the vehicle in cold weather a more efficient way to heat the passenger compartment is to do the following.

- Turn off or lower the blower, right after starting the engine.
- Engine temperature is still low and the air flow from the heater is still cold.
- After a few minutes of engine warm up, turn on or set the fan to a higher level and adjust the temperature setting to hot.

Controlling air intake

The air intake control is used to select the outside (fresh) air position or recirculated air position.



To change the air intake control position.

- Push the desired control button

Recirculated air position



The indicator light on the button illuminates when the recirculated air position is selected.

With the recirculated air position selected, air from the passenger compartment will be drawn through the heating system and heated or cooled according to the function selected.

Outside (fresh) air position



The indicator light on the button will turn off when the outside (fresh) air position is selected.

With the outside (fresh) air position selected, air enters the vehicle from

outside and is heated or cooled according to the function selected.

*** NOTICE**

Prolonged operation of the heater in the recirculated air position (without air conditioning selected) may cause fogging of the windshield and side windows, and the air within the passenger compartment may become stale.

In addition, prolonged use of the air conditioning with the recirculated air position selected will result in excessively dry air in the passenger compartment.

⚠ WARNING

- Continuously using the climate control system in the recirculated air position may allow humidity to increase inside the vehicle, which may fog the glass and obscure visibility.
- Do not sleep in a vehicle with the air conditioning or heating system on. It may cause serious harm or death due to a drop in the oxygen level and/or body temperature.
- Continuously using the climate control system in the recirculated air position can cause drowsiness or sleepiness, and loss of vehicle control. Set the air intake control

to the outside (fresh) air position as much as possible while driving.

Controlling fan speed

The fan speed control knob allows you to control the fan speed of the air flowing from the ventilation system.

The ENGINE START/STOP button must be in the ON position for fan operation.

To change the fan speed:

- Turn the knob to the right for higher speed or left for lower speed.



Turning off the blowers

To turn off the blowers:

- Turn the fan speed control knob to the "0" position.



Air conditioning (A/C)

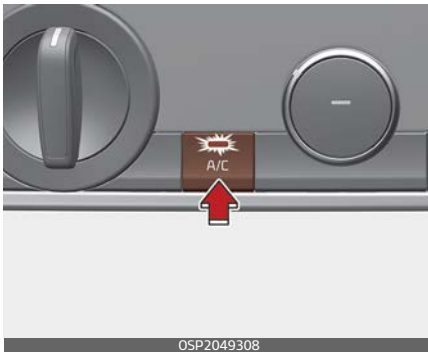

- Press the A/C button to turn the air conditioning system on (indicator light will illuminate).
- Press the button again to turn the air conditioning system off.

Automatic climate control system

The automatic climate control system uses cooling and heating to help maintain a pleasant environment inside the vehicle.

Type A



Type B

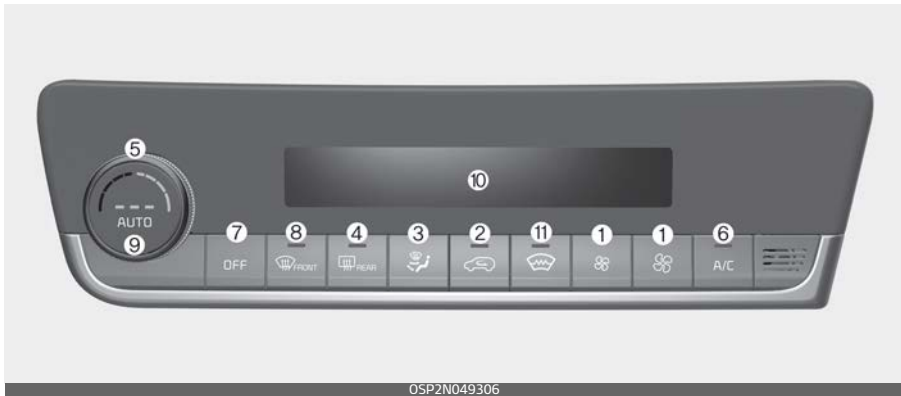

- 1. Fan speed control button
- 2. Air intake control button
- 3. Mode selection button
- 4. Rear window defroster button
- 5. Temperature control knob
- 6. Air conditioning (A/C) button
- 7. OFF button
- 8. Front windshield defroster button
- 9. AUTO (automatic control) button
- 10. Climate control display
- 11. Front glass heater (if equipped)

*** NOTICE**

Operating the blower when the ignition switch is in the ON position could cause the battery to discharge. Operate the blower when the engine is running.

Heating and air conditioning automatically

1. Press the AUTO button.
The modes, fan speeds, air intake and air-conditioning will be controlled automatically by setting the temperature.



You can control the wind strength in three stages by pushing the AUTO button during automatic operation.

Level	Indicator	LCD Display	Air flow
High			7~8
Medium			5~6
Low			1~4

- HIGH: Provide rapid air conditioning and heating with strong wind
- MEDIUM: Provide air conditioning and heating with medium strength wind
- LOW: It is suitable for drivers who prefer to soft wind.

When you select the temperature to HI or LO in AUTO mode, the wind strength is automatically set to 'HIGH'.

2. Set the temperature control switch to the desired temperature.



The climate control system is automatically controlled according to the desired temperature.

- To turn the automatic operation off, select any of the following buttons or switches:
 - Mode selection button
 - Air conditioning (A/C) button
 - Front windshield defroster button (Press the button one more time to deselect the front windshield defroster function. The 'AUTO' sign will illuminate on the information display once again.)
 - Fan speed control switch
The selected function will be controlled manually while other functions operate automatically.
- For your convenience and to improve the effectiveness of the climate control, use the AUTO button and set the temperature to 72 °F (22 °C).

*** NOTICE**

Do not place anything over the sensor located on the instrument panel to ensure better control of the heating and cooling system.

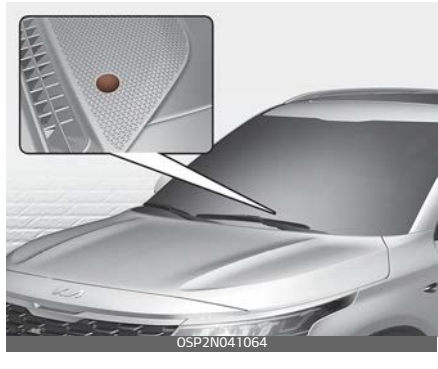

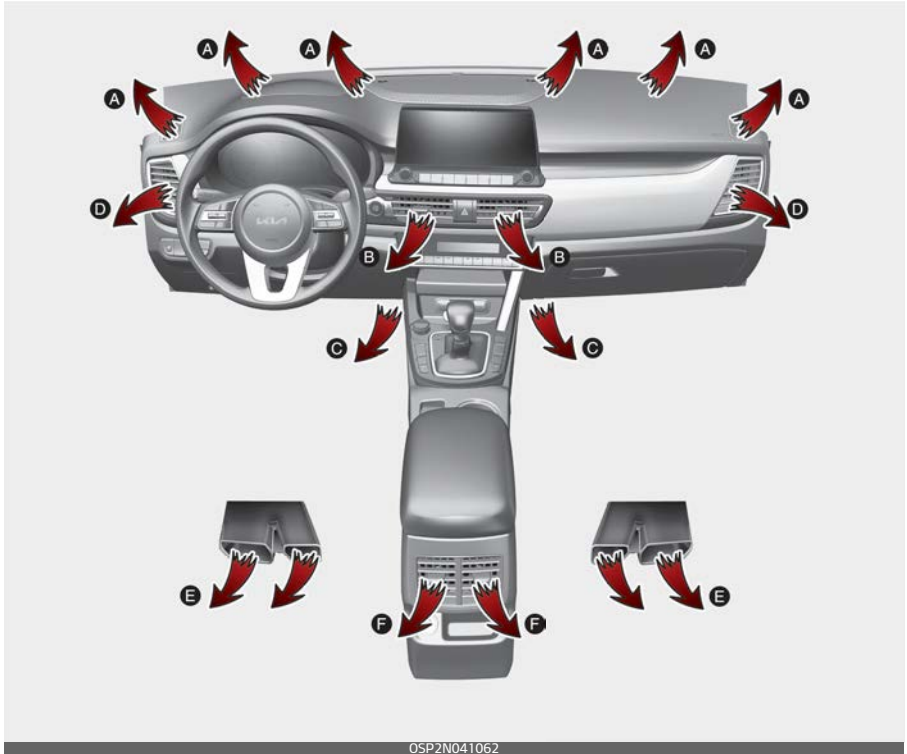

Heating and air conditioning manually

The heating and cooling system can be controlled manually by pressing buttons other than the AUTO button.



In this case, the system works sequentially according to the order of buttons selected.

1. Start the vehicle.
2. Set the mode to the desired position.
 - For improving the effectiveness of heating and cooling;
 - Heating: 
 - Cooling: 
3. Set the temperature control to the desired position.
4. Set the air intake control to the outside (fresh) air position.
5. Set the fan speed control to the desired speed.
 - If air conditioning is desired, turn the air conditioning system on.

Press the AUTO button in order to convert to fully automatic control of the system.

Mode selection

The mode selection button controls the direction of the air flow through the ventilation system.



The air flow outlet ports are switched in the following sequence:



Face-Level (B, D, F)

Air flow is directed toward the upper body and face. Additionally, each outlet can be controlled to direct the air discharged from the outlet.

Bi-Level (B, C, D, E, F)

Air flow is directed towards the face and the floor.

Floor-Level (A, C, D, E, F)

Most of the air flow is directed to the floor, with a small amount of the air being directed to the windshield, side window defrosters and side air vents.

Floor/Defrost-Level (A, C, D, E, F)

Most of the air flow is directed to the floor and the windshield with a small amount directed to the side window defrosters and side air vents.

Defrost-Level (A, D)

Most of the air flow is directed to the windshield with a small amount of air directed to the side window defrosters and side air vents.

Instrument panel vents

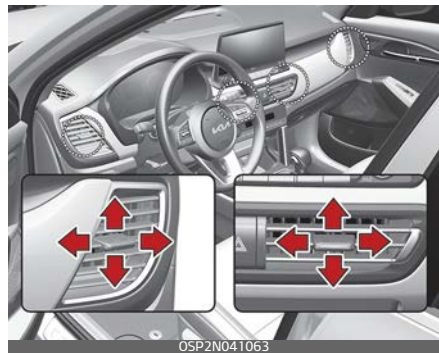

You can adjust the direction of air delivery from these vents using the vent control lever as shown.

Temperature control



The temperature will increase to the maximum (HI) by turning the knob all the way to the right.

The temperature will decrease to the minimum (Lo) by turning the knob all the way to the left.

When turning the knob, the temperature will increase or decrease by 1 °F/0.5 °C. When set to the lowest temperature setting, the air conditioning will operate continuously.

* NOTICE

When starting the vehicle in cold weather using manual temperature control, operate the system in the following method to improve heating.

- Turn off or lower the blower, right after starting the engine.
- Allow the engine to warm up during this time since the air flow from the heater is still cold.

- After a few minutes of engine warm up, turn on or set the fan to a higher level and adjust the temperature setting to hot.

Changing temperature scale

- To change the temperature display from Fahrenheit to Celsius and vice versa, press the OFF button, while pressing the AUTO button for 3 seconds or more.

The display will change from Centigrade to Fahrenheit, or from Fahrenheit to Centigrade. If the battery has been discharged or disconnected, the temperature mode display will reset to Fahrenheit.

Controlling air intake

This is used to select the outside (fresh) air position or recirculated air position.

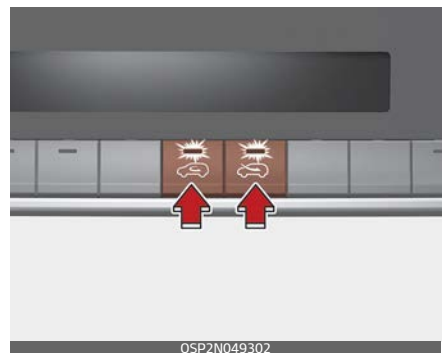

To change the air intake control position:

- Push the desired control button.

Outside (fresh) air position



With the outside (fresh) air position selected, air enters the vehicle from outside and is heated or cooled according to the function selected.

Recirculated air position



With the recirculated air position selected, air from the passenger compartment will be drawn through the heating system and heated or cooled according to the function selected.

Prolonged operation of the heater in the recirculated air position (without air conditioning selected) may cause fogging of the windshield and side windows and make the air in the passenger compartment stale. In addition, prolonged use of the air conditioning with the recirculated air position selected will result in excessively dry air in the passenger compartment.

Controlling fan speed

The fan speed can be set to the desired speed by operating the fan speed control button.

To change the fan speed:

- Press button right for higher speed, or press button left for lower speed.

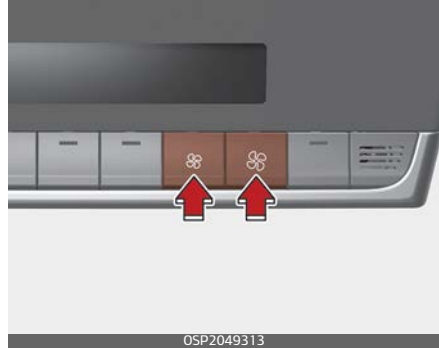

To turn the fan speed control off:

- Press the front blower OFF button.

Air conditioning (A/C)



- Press the A/C button to turn the air conditioning system on (indicator light will illuminate).
- Press the button again to turn the air conditioning system off.

⚠ WARNING

Reduced Visibility

Continuous use of the climate control system in the recirculated air position may allow humidity to

increase inside the vehicle, which may fog the glass and obscure visibility.

⚠ WARNING

Recirculated Air

Continued use of the climate control system in the recirculated air position can cause drowsiness or sleepiness, and loss of vehicle control. Set the air intake control to the outside (fresh) air position as much as possible while driving.

⚠ WARNING

Sleeping with A/C on

Do not sleep in a vehicle with the air conditioning or heating on as this may cause serious harm or death due to a drop in the oxygen level and/or body temperature.

Turning off the front air climate control

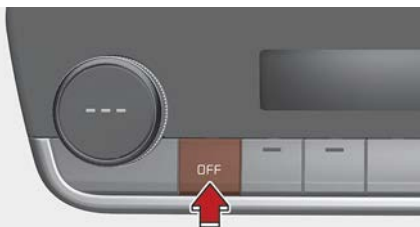

OSP2049315



- Press the OFF button to turn off the front and rear air climate control system. However, you can still operate the mode and air intake buttons as long as the ENGINE START/STOP button is in the ON position.

Windshield defrosting and defogging

When the windshield is covered with frost or moisture, the front view is blurred, so you should remove the frost and moisture.

⚠ WARNING

Windshield heating

Do not use the  or  position during cooling operation in extremely humid weather. The difference between the temperature of the outside air and the windshield could cause the outer surface of the windshield to fog up, causing loss of visibility. In this case, set the mode selection to the  position and fan speed control to the lower speed.

- To speed up the defrosting process, turn the temperature control all the way to the right and set the fan speed to the highest.
- If you want warm air to flow towards the floor while defrosting or defogging, set the mode to the floor-defrost position.
- Before driving, clear all snow and ice from the windshield, rear window, outside rear view mirrors, and all side windows.
- Clear all snow and ice from the hood and air inlet in the cowl grill to improve heater and defroster

efficiency and to reduce the probability of fogging up the inside of the windshield.

⚠ CAUTION



Do not place anything on the instrument panel which may cover the air outlets. Otherwise, air flow may be obstructed, preventing the windshield defoggers from defogging.



Defogging inside windshield with manual climate control system



1. Select any fan speed except "0" position.

2. Select desired temperature.
3. Select the  or  position.
The outside (fresh) air and air conditioning will be selected automatically.

If the air conditioning and outside (fresh) air position are not selected automatically, press the corresponding button manually.

Defrosting outside windshield with manual climate control system



1. Set the fan speed to the highest (extreme right) position.
2. Set the temperature to the extreme hot position.
3. Select the  position.
The outside (fresh) air and air conditioning will be selected automatically.

When starting the vehicle in cold weather a more efficient way to heat the passenger compartment is to do the following.

- Turn off or lower the blower, right after starting the engine.

- Engine temperature is still low and the air flow from the heater is still cold.
- After a few minutes of engine warm up, turn on or set the fan to a higher level and with adjust the temperature setting to hot.

* NOTICE

If the engine temperature is still cold after starting, then a brief engine warm up period may be required for the vented air flow to become warm or hot.

Defogging inside windshield with the automatic climate control

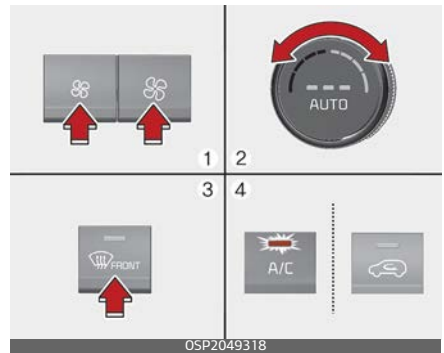

1. Set the fan speed to the desired position.
2. Select desired temperature.
3. Press the defroster button ()
The outside (fresh) air position will be selected automatically and the air conditioning will turn on according to the detected ambient temperature.

If the air conditioning and outside (fresh) air position are not selected automatically, adjust the corresponding button manually. If the  position is selected, lower fan speed is adjusted to a higher fan speed.

Defrosting outside windshield with automatic climate control

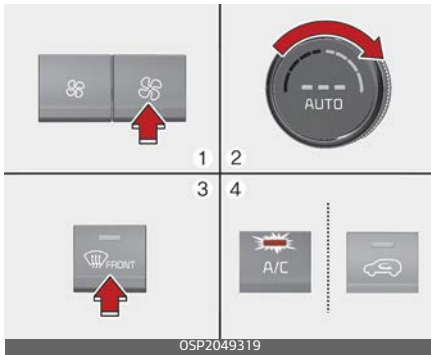

1. Set the fan speed to the highest position.
 2. Set the temperature to the extreme hot (HI) position.
 3. Press the defroster button ().
- The outside (fresh) air position will be selected automatically and the air conditioning will turn on according to the detected ambient temperature.

Defroster

The vehicle is equipped with a defroster for removing frost or fog from the rear window.

CAUTION

Conductors

To prevent damage to the conductors bonded to the inside surface of the rear window, never use sharp instruments or window cleaners containing abrasives to clean the window.

If you want to defrost and defog the front windshield, refer to "Windshield defrosting and defogging" on page 4-132.

Operating rear window defroster

The defroster heats the window to remove frost, fog and thin ice from the rear window, while the engine is on.

If there is heavy accumulation of snow on the rear window, brush it off before operating the rear defroster.

Type A

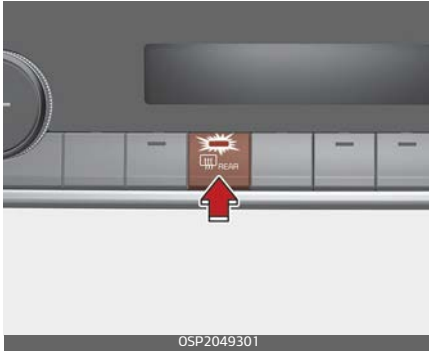

Type B



To activate the rear window defroster:

- Press the rear window defroster button located in the heater control panel.

The indicator on the rear window defroster button illuminates when the defroster is ON.

The rear window defroster automatically turns off after approximately 20 minutes or when the ENGINE START/STOP button is turned off.

To turn off the defroster:

- Press the rear window defroster button again.

Front glass heater (if equipped)

The front glass heater heats the window to remove frost, fog and thin ice from the interior and exterior of the front window, while the engine is running.

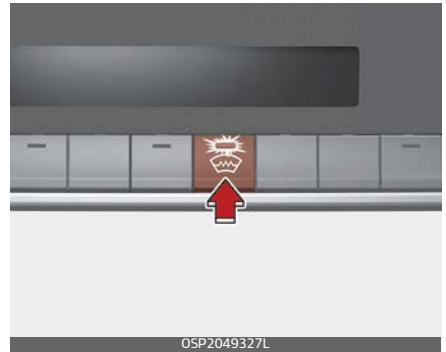



If there is heavy accumulation of snow on the front window, brush it off before operating the front glass heater.

To activate the front glass heater:

- Press the front glass heater button. The indicator on the front glass heater button illuminates when the front glass heater is ON.

The front glass heater automatically turns off after approximately 15 minutes or when the ignition switch is turned off. However, if you press the button again after the heater is turned off automatically after 15 minutes, the heater will stay on only for 5 minutes. To turn off the front glass heater while it is operating, press the front glass heater button again.

Defogging logic (if equipped)

To reduce the possibility of fogging up the inside of the windshield, the air intake or air conditioning is controlled automatically according to certain conditions such as  or  position.

To cancel automatic defogging logic or return to the automatic defogging logic, do the following.

Canceling/returning automatic defogging logic on manual climate control system



1. Turn the ENGINE START/STOP to the ON position.
2. Select the  position.
3. While holding the air conditioning button (A/C) pressed, press the air intake control button at least 5 times within 3 seconds. The indicator light in the air intake control button will blink 3 times. It indicates that the defogging logic is canceled or returned to the programmed status.

If the battery has been discharged or disconnected, it resets to the defog logic status.

Canceling/returning automatic defogging logic on automatic climate control system

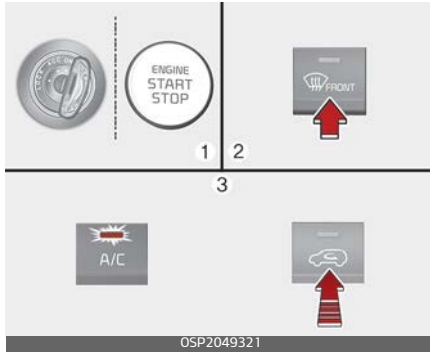

1. Turn the ENGINE START/STOP button to the ON position.
2. Press the defroster button ().
3. While pressing the air conditioning (A/C) button, press the air intake control button at least 5 times within 3 seconds.

The recirculation indicator blinks 3 times in 0.5 second of intervals. It indicates that the defogging logic is canceled or returned to the programmed status.

If the battery has been discharged or disconnected, it resets to the defog logic status.

Auto Defogging System (ADS) (only for automatic climate control system) (if equipped)

The Auto Defogging System (ADS) reduces the probability of fogging up the inside of the windshield by automatically sensing the moisture inside the windshield.

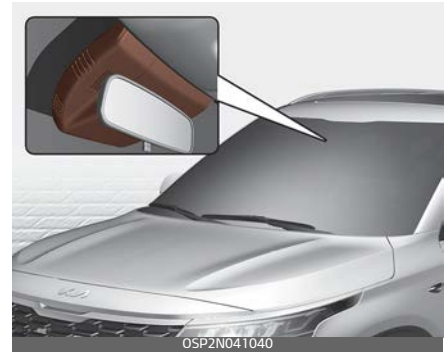

The ADS operates when the heater or air conditioning is on.

The indicator illuminates when the ADS senses the moisture on the inside of the windshield and operates.

The ADS addresses excess moisture on the inside of the windshield in stages. For example if auto defogging does not defog inside the windshield at step 1, it tries to defog again at step 2.

1. Outside air position.
2. Operating the air conditioning.
3. Increasing air flow toward the windshield.
4. Blowing air flow toward the windshield.

Turning the ADS on or off

- Press the front windshield defroster button for 3 seconds when the ENGINE START/STOP button is in the ON position. When the ADS system is canceled, the defroster button indicator will blink 3 times per 0.5 sec.
- To reset the ADS system to ON, hold the front windshield defrost for 0.25 sec and the "ADS OFF" will be removed from the climate control screen.

⚠ CAUTION

Do not remove the sensor cover located on the upper end of the passenger side windshield glass. Damage to the system parts could occur and may not be covered by your vehicle warranty.

Storage compartment

These compartments can be used to store small items required by the driver or passengers.

- To avoid possible theft, do not leave valuables in the storage compartment.
- Always keep the storage compartment covers closed while driving. Do not place too many items in the storage compartment to make sure that the compartment can be closed securely.

⚠ WARNING**Flammable materials**

Do not store, propane cylinders or other flammable/explosive materials in the vehicle. These items may catch fire and/or explode if the vehicle is exposed to hot temperatures for extended periods.

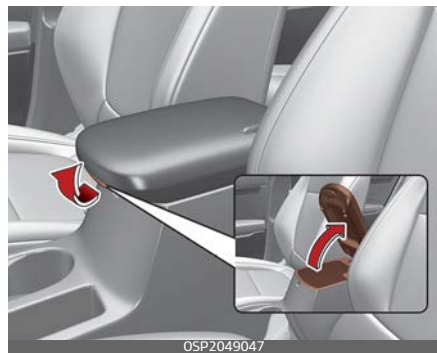
Center console storage

To open the center console storage:

- Pull up the lever.

Sliding armrest (if equipped)

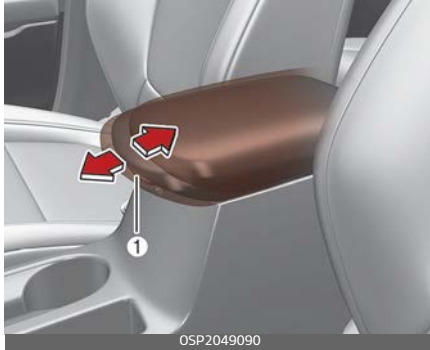

To move forward:

- Grab the lever (1) in front portion of the armrest and pull it forward.

To move rearward:

- Grab the lever (1) in front portion of the armrest and push it rearward.

⚠ WARNING

Do not grab the front portion of the armrest when moving the armrest rearward. It may pinch your fingers.

Glove box



To open the glove box:

- Pull the handle and the glove box will automaticall open.

Close the glove box after use.

⚠ WARNING

Glove Box

To reduce the risk of injury in an accident or sudden stop, always keep the glove box door closed while driving.

*** NOTICE**

If the temperature control switch is in the warm or hot position, warm or hot air will flow into the glove box.

Escort light

When the vehicle is turned OFF and the driver's door is opened, the puddle lamp will come on for 30 seconds. If the driver's door is closed

within the 30 seconds, the puddle lamp will turn off after 15 seconds. If the driver's door is closed and locked, the puddle lamp will turn off immediately.

The Puddle Lamp Escort Light will turn on only the first time the driver's door is opened after the engine is turned off.

Luggage net holder



To keep items from shifting in the cargo area, you can use the 4 holders located in the cargo area to attach the luggage net^{*1}.

If necessary, Kia recommends contacting an authorized Kia dealer.

⚠ CAUTION

To prevent damage to the goods or the vehicle, be careful when carrying fragile or bulky objects in the luggage compartment.

⚠ WARNING

DO NOT over-stretch the luggage net and ALWAYS keep your face and body out of the luggage net's recoil path. Failure to comply with these instructions may result in severe facial injuries. DO NOT use the luggage net when the strap has visible signs of wear or damage.

Increase cargo space (if equipped)

If you want to increase cargo space,

1. Grasp the handle on the top of the cover and lift it.

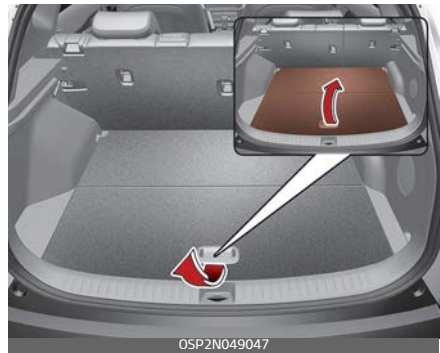

2. Fold the rear part of the luggage board frontward.

*1. if equipped



OSP2N049027

3. Pull the luggage board hinge to the end of sliding slot and it will fall down lower to increase cargo space.

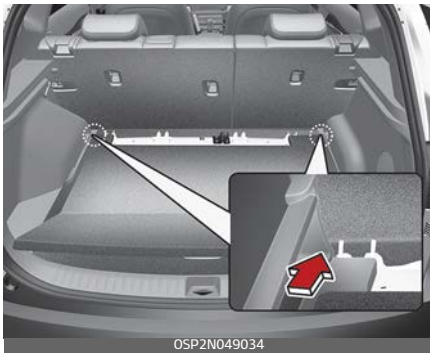

OSP2N049034

4. Slide it forward. (refer to the above pictures).

Interior features

There are various features inside the vehicle for the convenience of the occupants.

Ambient light and Sound mood lamp (if equipped)

The Ambient light and Sound mood lamps (if equipped) are applied to the front passenger's crash pad and front door speakers.



OSP2N049028



OSP2N041065

When the headlamp light is on, the ambient light is on at the same time Sound mood lamps (if equipped) could be set in the audio or infotainment menu.

Refer to the infotainment manual for details.

Cigarette lighter (if equipped)

For the cigarette lighter to work, the ignition switch must be in the ACC position or the ON position.



- To use the cigarette lighter, push it all the way into its socket. When the element has heated, the lighter will pop out to the "ready" position.

Kia recommends to use parts for replacement from an authorized Kia dealer.

⚠ WARNING

- Do not hold the lighter in after it is already heated because it will overheat.
- If the lighter does not pop out within 30 seconds, remove it to prevent overheating.
- Do not insert foreign objects into the socket of the cigarette lighter.

It may damage the cigarette lighter.

⚠ CAUTION

The use of plug-in accessories (shavers, hand-held vacuums, and coffee pots, etc.) may damage the socket or cause electrical failure.

Ashtray (if equipped)

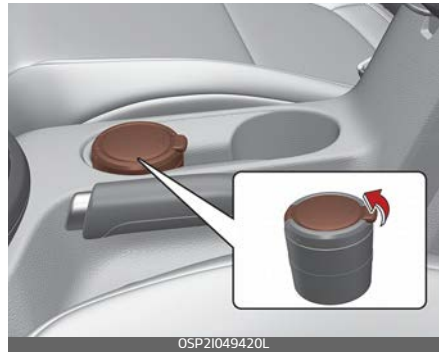

- To use the ashtray, open the cover.
- To clean or empty the ashtray, pull it out.

Use the ashtray by leaning it to the cup holder right beside.

⚠ WARNING

Ashtray use

- Do not use the vehicle's ashtrays as waste receptacles.
- Putting lit cigarettes or matches in an ashtray with other combustible materials may cause a fire.

Cup holder

The front and rear seats of the vehicle have cup holders to accommodate cups.

⚠ WARNING

Hot liquids

Do not place uncovered cups with hot liquid in the cup holder while the vehicle is in motion. If the hot liquid spills, you may burn yourself. Such a burn to the driver could lead to loss of control of the vehicle.

⚠ CAUTION

- Keep your drinks sealed while driving to prevent spilling your drink. If liquid spills, it may get into the vehicle's electrical/electronic system and damage electrical/electronic parts.
- When cleaning spilled liquids, do not use heat to dry the cup holders. This may damage the cup holder.

Front



Rear (if equipped)



Cups or small beverage cans may be placed in the cup holders.

Seat warmer (if equipped)

The seat warmer is provided to warm the front seats during cold weather.

Front seat



Rear seat

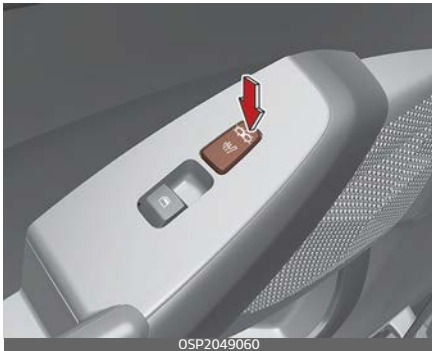

With the ignition switch in the ON position:

- Push either of the switches to warm the driver's seat or the front passenger's seat.

During mild weather or under conditions where the operation of the seat warmer is not needed, keep the switches in the "OFF" position.

Temperature control (Manual)

Each time you press the switch, the temperature setting of the seat will change as follows:

Front seat

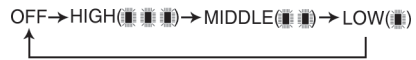

Rear seat



The seat warmer defaults to the OFF position whenever the ignition switch or START/STOP button is turned on.

Temperature control (Automatic)

The seat warmer starts to automatically control the seat temperature in order to prevent low-temperature burns after being manually turned ON.

Front seat



You may manually press the button to increase the seat temperature. However, it soon returns to the automatic mode again. When pressing the switch for more than 1.5 seconds with the seat warmer operating, the seat warmer will turn OFF. The seat warmer defaults to the OFF position whenever the igni-

tion switch or START/STOP button is in the ON position.

*** NOTICE**

With the seat warmer switch in the ON position, the heating system in the seat turns off or on automatically depending on the seat temperature.

⚠ WARNING

Seat warmer burns

The seat warmer may cause burns, even at low temperature, if used over a long period of time. Never allow passengers who may not be able to take care of themselves to be exposed to the risk of seat heater burns. These include:

1. Infants, children, elderly or disabled persons, or hospital outpatients
2. Persons with sensitive skin or those that burn easily
3. Fatigued individuals
4. Intoxicated individuals
5. Individuals taking medication that can cause drowsiness or sleepiness (sleeping pills, cold tablets, etc.)

Air ventilation seat (if equipped)

Front seat



The temperature setting of the seat changes according to the switch position.

- To ventilate your seat cushion, press the switch. Each time you press the switch, the airflow will change as follows:

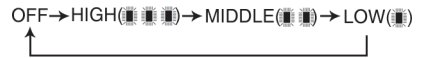

The seat warmer (with air ventilation) defaults to the OFF position whenever the ENGINE START/STOP button is turned on.

*** NOTICE**

This function is designed to automatically change the temperature setting of the seat (High -> Low) to maintain maximum comfort inside in case the engine is stopped by ISG (Idle Stop and Go) system (if equipped).

⚠ CAUTION

Seat damage

- When cleaning the seats, do not use an organic solvent such as paint thinner, benzene, alcohol and gasoline. Doing so may damage the air ventilation seat.
- Do not place heavy or sharp objects on the seat. Those things may damage the air ventilation seat.
- Be careful not to spill liquid such as water or beverages on the seat. If you spill some liquid, wipe the seat with a dry towel. Before using the air ventilation seat, dry the seat completely.

- To use the sun visor for the side window, pull it downward, unsnap it from the bracket (1) and swing it to the side (2). You can slide the sun visor if necessary (3). (if equipped)
 - To use the vanity mirror, pull down the visor and slide the mirror cover (4).
- The ticket holder (5) is provided for holding a tollgate ticket.

⚠ CAUTION

Vanity mirror lamp

To prevent unnecessary charging system drain, close the vanity mirror cover securely after using the mirror.

Sun visor

Use the sun visor to shield direct light through the front or side windows.

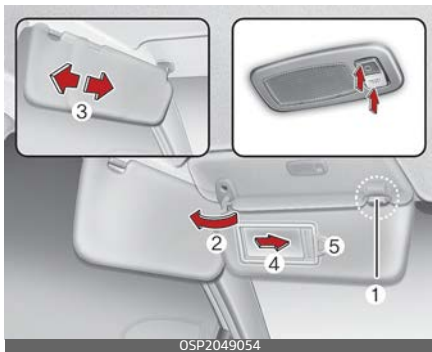

- To use the sun visor, pull it downward.

USB charger (if equipped)

The USB car charger allows drivers to charge their digital devices like smartphone, and PC tablets. Connect the cable to the USB port, charging will begin.

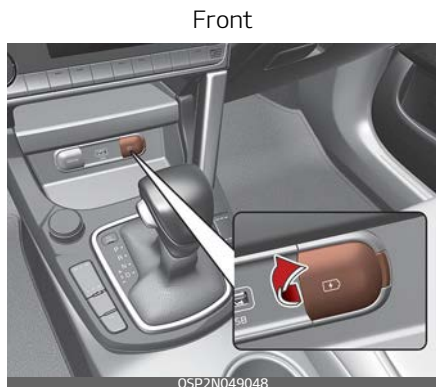

Rear

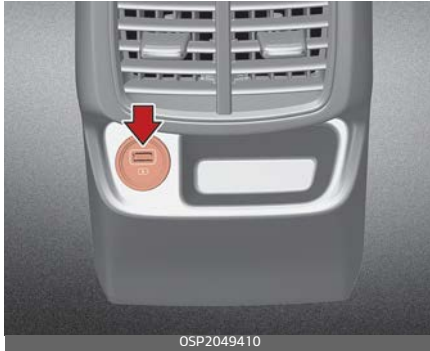

The USB car charger is available with either the ACC state or the ignition on. However, we recommend connecting the USB port and digital devices with the engine running. See the display screen of the device to check its charging process completion. Your smartphone or tablet PC could get heated up while charging. This is no reason to worry, as it doesn't impact life or functions of the device. For safety, charging can be stopped if the battery gets heated up to a certain point of temperature that the devices can be negatively affected. Charging some digital devices is not available or requires special dedicated adapters if their charging methods don't fit the way the USB car charger works.

⚠ CAUTION

- Use the USB car charger with the ignition on. Otherwise, vehicle battery can be discharged.
- Use the official USB cable of the manufacturer of the digital device to be charged.
- Make sure that no foreign objects, drinks, and water come into contact with the USB car charger. Water or foreign objects can damage the USB charger.
- Do not charge a device in which the current consumption exceeds 2.1 A.
- Do not connect an electrical device that generates excessive electromagnetic noise to the USB car port. If you do so, noise can be caused or vehicle electronic devices can be interrupted while audio or AV is on.
- If the charger is connected incorrectly, it can cause serious damage on the devices. Please note that damages due to incorrect usage are not covered by warranty service.

Power outlet (if equipped)

The power outlet is designed to provide power for mobile telephones or other devices designed to operate with vehicle electrical systems.

Front



OSP2N049049

The devices should draw less than 10 amps with the vehicle on.

- Use the power outlet only when the vehicle is on and remove the accessory plug after use. Using the accessory plug for prolonged periods of time with the vehicle off could cause the battery to discharge.
- Only use 12 V electric accessories which are less than 10 A in electric capacity.
- Adjust the air-conditioner or heater to the lowest operating level when using the power outlet.
- Close the cover when not in use.

- Some electronic devices can cause electronic interference when plugged into a vehicle's power outlet. These devices may cause excessive audio static and malfunctions in other electronic systems or devices used in your vehicle.
- Push the plug in as far as it will go. If the plug is not properly inserted into the outlet, the plug may overheat and the fuse may open.
- For electronic devices equipped with batteries, only plug in the devices with reverse current protection. The current from the battery may flow into the vehicle's electrical/electronic system and cause system malfunction.

⚠ WARNING

Electric shock

Do not put a finger or a foreign object (pen, etc.) into a power outlet and do not touch it with a wet hand. You may get an electric shock.

Wireless smart phone charging system (if equipped)

A wireless smart phone charging system is located in front of the center console.



Firmly close all doors, and turn the vehicle on. To start wireless charging, place the smart phone capable of wireless charging on the wireless charging pad.

For best wireless charging results, place the smart phone on the center of the charging pad.

The wireless charging system is designed for smart phones compatible with Qi technology. Please refer to the smart phone accessory cover or the smart phone manufacturer homepage to check whether your smart phone supports Qi function.

Charging smart phone wirelessly

1. Remove any object on the smart phone charging pad including the smart key. If there is any foreign object on the pad other than a smart phone, the wireless charging function may not operate properly.
2. Place the smart phone on the center of the wireless charging pad.
The indicator light will change to orange once the wireless charging begins. After the charging is complete, the orange light will change to green.

You can choose to turn the wireless charging function on or off by selecting the USM on the instrument cluster. (Please refer to "Instrument cluster" on page 4-53 for details).

If the wireless charging does not work, gently move your smart phone around the pad until the charging indicator light turns orange.

Depending on the smart phone, the charging indicator light may not turn green even after the charging is complete.

If the wireless charging is not functioning properly, the orange light will blink and flash for ten seconds then turn off. In such cases, remove the smart phone from the pad and

replace it on the pad again, or double check the charging status.

If you leave the smart phone on the charging pad when the vehicle is turned off, the vehicle will alert you through warning messages and sound (applicable for vehicles with the voice guidance function) after the 'Goodbye' function on the instrument cluster ends.

For some manufacturers' smart phones, the system may not warn you even though the smart phone is left on the wireless charging unit. This is due to the particular characteristic of the smart phone and not a malfunction of the wireless charging.

⚠ WARNING

Distracted driving

Driving while distracted can result in a loss of vehicle control that may lead to an accident, severe bodily injury, and/or death. The driver's primary responsibility is in the safe and legal operation of a vehicle, and use of any handheld devices, other equipment, or vehicle systems which take the driver's eyes, attention and focus away from the safe operation of a vehicle, or which are not permissible by law, should never be used during the operation of the vehicle.

⚠ CAUTION

Liquid in Wireless Smart Phone Charger

To prevent liquid from damaging the wireless smart phone charging system in your vehicle, be sure not to spill liquid over the charging system.

⚠ CAUTION

Metal in Wireless Charging system

If any metallic object such as a coin is located between the wireless charging system and the smart phone, the charging may be disrupted. Also, the metallic object may heat up and potentially damage the charging system. If there is any metallic object between the smart phone and the charging pad, immediately remove the smart phone. Remove the metallic object after it has cooled down.

*** NOTICE**

- When the interior temperature of the wireless charging system rises above a set temperature, the wireless charging will cease to function. After the interior temperature drops below the threshold, the wireless charging function will resume.
- The wireless charging may not function properly when there is a

- heavy accessory cover on the smart phone.
- The wireless charging will stop when using the wireless smart key search function to prevent radio wave disruption.
 - The wireless charging will stop when the smart key is moved out of the vehicle with the vehicle in ON.
 - The wireless charging will stop when any of the doors are opened (applicable for vehicles equipped with smart keys).
 - The wireless charging will stop when the vehicle is turned OFF.
 - The wireless charging will stop when the smart phone is not in complete contact with the wireless charging pad.
 - Items equipped with magnetic components such as credit card, telephone card, bankbook or any transportation ticket may become damaged during wireless charging.
 - Place the smart phone on the center of the charge pad for best results. The smart phone may not charge when placed near the rim of the charging pad. When the smart phone does get charged, it may heat up excessively.
 - For smart phones without built-in wireless charging system, an appropriate accessory has to be equipped in order to use the vehicle's wireless charging system.
 - Certain smart phones may display messages on a weak current. This is due to the particular characteristics of that smart phone, and does not imply a malfunction of the wireless charging function.
 - The indicator light of some manufacturers' smart phones may still be orange after the smart phone is fully charged. This is due to the particular characteristic of the smart phone and not a malfunction of the wireless charging.
 - When any smart phone without a wireless charging function or a metallic object is placed on the charging pad, a small noise may sound. This small noise is due to the vehicle discerning compatibility of the object placed on the charging pad. It does not affect your vehicle or the smart phone in any way.
 - The wireless smart phone charging system may not support certain smart phones which are not verified for Qi specification .
 - When placing your smart phone on the charging pad, position the phone in the middle of the pad for maximum efficiency. If your smart phone is off to the side, the charging speed may slow down, and in some cases, your phone may experience higher heat conduction.

- When charging some smart phones with a self-protection feature, the wireless charging speed may decrease, and the charging may stop.
- A smart phone that supports the wireless charging can only be charged wirelessly.
- The wireless charging pad has an internal cooling system which can create noise to keep your phone cool while it charges.

This device complies with part 15 of the FCC Rules

Operation is subject to the following two conditions:

1. This device may not cause harmful interference.
2. This device must accept any interference received, including interference that may cause undesired operation.

Coat hook

A Coat hook is next to the rear grab handle.



* This actual feature may differ from the illustration.

⚠ CAUTION

Hanging clothing

Do not hang heavy clothes, since they may damage the hook.

⚠ WARNING

Do not hang objects, such as hangers or hard objects, other than clothes. Also, do not put heavy, sharp or breakable objects in the clothing's pockets. In an accident or when the curtain air bag is inflated, it may cause vehicle damage or body injury.



Floor mat anchor(s) (if equipped)



When using a floor mat on the front floor carpet, make sure it attaches to the floor mat anchor(s) in your vehicle. This keeps the floor mat from sliding forward.

⚠ WARNING

After market floor mat

Do not install after market floor mats that are not capable of being securely attached to the vehicle's floor mat anchors.

Unsecured floor mats can interfere with pedal operation.

The following must be observed when installing ANY floor mat to the vehicle.

- Ensure that the floor mats are securely attached to the vehicle's floor mat anchor(s) before driving the vehicle.
- Do not use ANY floor mat that cannot be firmly attached to the vehicle's floor mat anchors.
- Do not stack floor mats on top of one another (e.g., all-weather rubber mat on top of a carpeted floor mat). Only a single floor mat should be installed in each position.

Cargo area cover

Use the cargo area cover to hide items stored in the cargo area.

Removal and installation

To remove the cargo area cover:

1. Remove straps from both sides of the cargo area cover.



2. While lifting the cover up, hold the area near the front slots. Then, pull up the cover at approximately 45 ° angle.

⚠ WARNING

Folded cover may block the rear view. Put the folded cover in the appropriate position.

⚠ WARNING

Do not place objects on the cargo area cover. Such objects may be thrown about inside the vehicle and possibly injure vehicle occupants during an accident or when braking.

⚠ CAUTION

Since the cargo area cover may be damaged or malformed, do not put luggage on it when it is used.

Exterior features

Roof rack (if equipped)

If the vehicle has a roof rack, you can load cargo on top of your vehicle.



Crossbars and fixing components needed to install the roof rack on your vehicle may be obtained from an authorized Kia dealer.

*** NOTICE**

- The crossbars (if equipped) should be placed in the proper load carrying positions prior to placing items onto the roof rack.
- If the vehicle is equipped with a sunroof, be sure not to position cargo onto the roof rack in such a way that it could interfere with sunroof operation.
- When the roof rack is not being used to carry cargo, the crossbars may need to be repositioned if wind noise is detected.

⚠ CAUTION**Loading Roof Rack**

- When carrying cargo on the roof rack, take the necessary precautions to make sure the cargo does not damage the roof of the vehicle.
- When carrying large objects on the roof rack, make sure they do not exceed the overall roof length or width.
- When you are carrying cargo on the roof rack, do not operate the sunroof (if equipped). This can damage the sunroof.

The following specification is the maximum weight that can be loaded onto the roof rack. Distribute the load as evenly as possible across the crossbars (if equipped) and roof rack and secure the load firmly.

ROOF RACK	220 lbs. (100 kg) EVENLY DISTRIBUTED
--------------	---

Loading cargo or luggage in excess of the specified weight limit on the roof rack may damage your vehicle.

⚠ WARNING

- The vehicle center of gravity will be higher when items are loaded onto the roof rack. Avoid sudden starts, braking, sharp turns, abrupt maneuvers or high speeds that may result in loss of vehicle control or rollover resulting in an accident.
- Always drive slowly and turn corners carefully when carrying items on the roof rack. Severe wind updrafts, caused by passing vehicles or natural causes, can cause sudden upward pressure on items loaded on the roof rack. This is especially true when carrying large, flat items such as wood panels or mattresses. This could cause the items to fall off the roof rack and cause damage to your vehicle or others around you.

To prevent damage or loss of cargo while driving, check frequently before and while driving to make sure the items on the roof rack are securely fastened.

Audio system

* NOTICE

If you install an aftermarket HID head lamp, your vehicle's audio and electronic device may malfunction.

* If your vehicle is equipped with Infotainment System, refer to a separately supplied manual for detailed information.

Antenna



The roof antenna transmits and receives wireless signals such as AM/FM, Sirius XM, GNSS, etc..

* The signals which antenna can transmit and receive vary by the vehicle option.

USB port

You can use a USB port to plug in a USB.



How vehicle radio works

FM reception

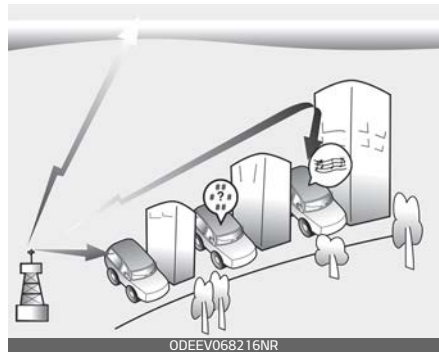

AM and FM radio signals are broadcast from transmitter towers located around your city. They are intercepted by the radio antenna on your vehicle. This signal is then processed by the radio and sent to your vehicle speakers.

However, in some cases the signal coming to your vehicle may not be strong and clear.

This can be due to factors, such as the distance from the radio station, closeness of other strong radio stations or the presence of buildings, bridges or other large obstructions in the area.

AM reception

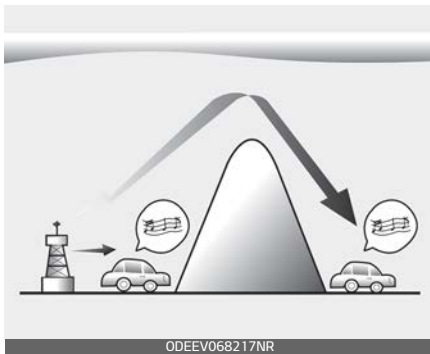

AM broadcasts can be received at greater distances than FM broadcasts. This is because AM radio waves are transmitted at low frequencies. These long distance, low frequency radio waves can follow the curvature of the earth rather than traveling straight. In addition, they curve around obstructions resulting in better signal coverage.

FM radio station

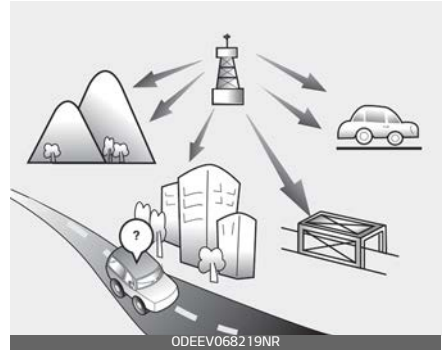

FM broadcasts are transmitted at high frequencies and do not bend to follow the earth's surface. Because of this, FM broadcasts generally begin to fade within short distances from the station. Also, FM signals are easily affected by buildings, mountains, and obstructions. This can lead to undesirable or unpleasant listening conditions which might lead you to believe a problem exists with your radio.

The following conditions are normal and do not indicate radio trouble:

- Fading – As your vehicle moves away from the radio station, the signal will weaken and sound will begin to fade. When this occurs, we suggest that you select another station with a stronger signal.

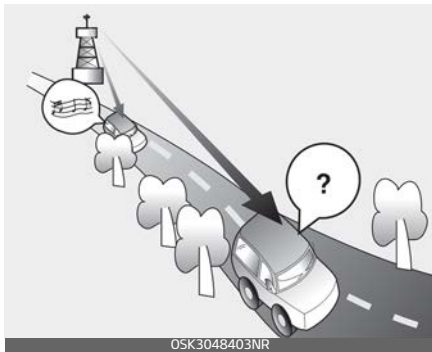

- Flutter/Static – Weak FM signals or large obstructions between the transmitter and your radio can disturb the signal causing static or fluttering noises to occur. Reducing the treble level may lessen this effect until the disturbance clears.

- Station Swapping – As an FM signal weakens, another more powerful signal near the same frequency may begin to play. This is because your radio is designed to lock onto the clearest signal. If this occurs, select another station with a stronger signal.

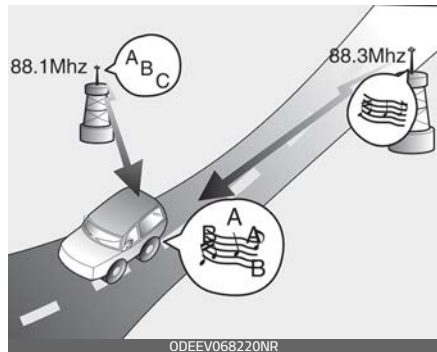

- Multi-Path Cancellation – Radio signals being received from several directions can cause distortion or fluttering. This can be caused by a direct and reflected signal from the same station, or by signals from two stations with close frequencies. If this occurs, select another station until the condition has passed.

Using a cellular phone or a two-way radio

When a cellular phone is used inside the vehicle, noise may be produced from the audio system. This does not mean that something is wrong with the audio equipment. In such a case, try to operate mobile devices as far from the audio equipment as possible.

⚠ CAUTION

When using a communication system, such as a cellular phone or a radio set, inside the vehicle, a separate external antenna must be fitted. When a cellular phone or a radio set is used with only the internal antenna, it may interfere with the vehicle's electrical system and adversely affect the safe operation of the vehicle.

⚠ WARNING

Cell phone use

Do not use a cellular phone while driving. Stop at a safe location to use a cellular phone.

Declaration of Conformity

FCC

This equipment has been tested and found to comply with the limits for a Class B digital device, pursuant to part 15 of the FCC Rules. These limits are designed to provide reasonable protection against harmful interference in a residential installation.

This equipment generates, uses and can radiate radio frequency energy and, if not installed and used in accordance with the instructions, may cause harmful interference to radio communications. However, there is no guarantee that interference will not occur in a particular installation. If this equipment does cause harmful interference to radio or television reception, which can be determined by turning the equipment off and on, the user is encouraged to try to correct the interference by one or more of the following measures:

- Reorient or relocate the receiving antenna.
- Increase the separation between the equipment and receiver.
- Connect the equipment into an outlet on a circuit different from that to which the receiver is connected.

- Consult the dealer or an experienced radio/TV technician for help.

⚠ CAUTION

Any changes or modifications to this device that is not explicitly approved by the manufacturer could void your authority to operate this equipment.

This device complies with part 15 of the FCC Rules. Operation is subject to the following two conditions:

1. This device may not cause harmful interference.
2. This device must accept any interference received, including interference that may cause undesired operation.

This equipment complies with FCC radiation exposure limits set forth for an uncontrolled environment.

This equipment should be installed and operated with minimum 8 in (20 cm) between the and your body. This transmitter must not be collocated or operating in conjunction with any other antenna or transmitter unless authorized to do so by the FCC.

Be sure the exhaust system does not leak.	5-7
Before driving	5-8
Key positions	5-10
• Illuminated ignition switch	5-10
• Ignition switch position.....	5-10
• Starting the engine	5-12
ENGINE START/STOP button	5-13
• Illuminated ENGINE START/STOP button	5-13
• ENGINE START/STOP button position.....	5-13
• Starting the engine	5-15
Vehicle Auto Shut-off system	5-17
• Prerequisite for activation.....	5-17
• Setting Shut-off Time.....	5-17
• Resetting the time	5-18
• Canceling the Vehicle Auto Shut-off system	5-18
All Wheel Drive (AWD) system	5-18
• AWD mode	5-19
• For safe All Wheel Drive (AWD) operation.....	5-21
Dual clutch transmission (DCT)	5-25
• Dual clutch transmission operation	5-26
• LCD display for transmission temperature and warning message	5-27
• Transmission ranges.....	5-31
• Shift lock system.....	5-34
• Good driving practices	5-35
Intelligent variable transmission (IVT)	5-36
• Intelligent Variable Transmission (IVT) operation	5-37
• Shift lock system.....	5-42

5 Driving your vehicle

- Good driving practices 5-43
- Brake system 5-44**
- Power brakes 5-44
- Parking Brake (Hand type) 5-46
- Electronic Parking Brake (EPB) 5-48
- Anti-lock Brake System (ABS) 5-54
- AUTO HOLD 5-55
- Electronic Stability Control (ESC) system 5-58
- Vehicle Stability Management (VSM) system 5-61
- Hill-start Assist Control (HAC) 5-63
- Downhill Brake Control (DBC) 5-64
- Good braking practices 5-66
- Idle Stop and Go (ISG) system 5-67**
- Auto stop 5-68
- Auto start 5-69
- Operating conditions 5-69
- Deactivating the ISG 5-70
- ISG malfunction 5-70
- Drive mode integrated control system 5-71**
- Forward Collision-Avoidance Assist (FCA) (Front view camera only) 5-74**
- Forward Collision-Avoidance Assist setting and activation 5-75
- Forward Collision-Avoidance Assist warning message and brake control 5-77
- Detecting sensor 5-79
- Forward Collision-Avoidance Assist malfunction 5-81
- Limitations of Forward Collision-Avoidance Assist 5-82

Forward Collision-Avoidance Assist (FCA) (Sensor fusion)	5-89
• Basic function.....	5-89
• Junction Turning function	5-89
• Detecting sensor	5-90
• Forward Collision-Avoidance Assist settings.....	5-91
• Forward Collision-Avoidance Assist operation	5-93
• Forward Collision-Avoidance Assist malfunction and limitations	5-97
• This device complies with Part 15 of the FCC rules.	5-104
• Radio frequency radiation exposure information:.....	5-104
Lane Keeping Assist (LKA)	5-105
• Lane Keeping Assist operation.....	5-106
• Warning light and message	5-109
• Limitations of Lane Keeping Assist	5-111
Blind-Spot Collision-Avoidance Assist (BCA)	5-113
• Blind-Spot Collision-Avoidance Assist description.....	5-113
• Blind-Spot Collision-Avoidance Assist setting and activation	5-115
• Warning and Blind-Spot Collision-Avoidance Assist control	5-117
• Detecting sensors	5-119
• Limitations of the Blind-Spot Collision-Avoidance Assist	5-122
• Driving on a curved road	5-124
• Driving where the road is merging/dividing	5-125
• Driving on a slope	5-125
• Driving where the heights of the lanes are different ..	5-125
• Driving where there is a structure beside the road	5-126
• This device complies with Part 15 of the FCC rules.	5-126

5 Driving your vehicle

Driver Attention Warning (DAW)	5-126
• Driver Attention Warning setting and operation	5-126
• Display of the driver's attention level	5-127
• Taking a break	5-128
• Resetting Driver Attention Warning	5-128
• Driver Attention Warning standby	5-129
• Driver Attention Warning malfunction	5-129
• Leading Vehicle Departure Alert	5-131
Cruise Control (CC)	5-132
• Driving Assist button	5-133
• Setting Cruise Control speed	5-133
• Increasing Cruise Control set speed	5-134
• Accelerating temporarily with Cruise Control on	5-134
• Canceling Cruise Control	5-134
• Resuming cruising speed at more than approximately 20 mph (30 km/h)	5-135
• Turning Cruise Control off	5-135
Smart Cruise Control (SCC)	5-136
• Driving Assist Button	5-137
• Smart Cruise Control speed	5-138
• Setting vehicle distance	5-142
• When the lane ahead is clear:	5-143
• When there is a vehicle ahead of you in your lane:	5-143
• Radar to detect distance to the vehicle ahead	5-145
• Smart Cruise Control malfunction message	5-146
• Limitations of Smart Cruise Control	5-147
• This device complies with Part 15 of the FCC rules. ...	5-151
• Radio frequency radiation exposure information:	5-151
Navigation-based Smart Cruise Control (NSCC)	5-151

- Navigation-based Smart Cruise Control setting5-151
- Operating conditions.....5-152
- Navigation-based Smart Cruise Control operation5-152
- Displaying the operating conditions.....5-152
- Lane Following Assist (LFA).....5-155**
- Lane Following Assist operation5-156
- Warning message5-158
- Lane Following Assist malfunction5-158
- Limitations of Lane Following Assist5-159
- Highway Driving Assist (HDA).....5-161**
- Detecting sensor5-162
- Highway Driving Assist Setting and activation5-162
- Operating conditions.....5-163
- Highway Driving Assist operation5-163
- HDA malfunction.....5-165
- This device complies with Part 15 of the FCC rules.5-167
- Radio frequency radiation exposure information:.....5-167
- Rear Cross-Traffic Collision-Avoidance Assist (RCCA)5-168**
- Rear Cross-Traffic Collision-Avoidance Assist description5-168
- Detecting sensor5-169
- Rear Cross-Traffic Collision setting and activation5-169
- Warning and function control.....5-171
- Rear Cross-Traffic Collision Warning5-171
- Detecting sensors5-175
- Limitations of Rear Cross-Traffic Collision5-177
- This device complies with Part 15 of the FCC rules.5-180
- Economical operation.....5-181**

5 Driving your vehicle

Special driving conditions	5-182
Winter driving	5-186
Trailer towing	5-190
Vehicle load limit	5-191
• Steps For Determining Correct Load Limit -.....	5-192
• Certification label.....	5-193
Vehicle weight	5-195

DRIVING YOUR VEHICLE

Be sure the exhaust system does not leak.

The exhaust system should be checked whenever the vehicle is raised to change the oil or for any other purpose.

If you hear a change in the sound of the exhaust or if you drive over something that strikes the underneath side of the vehicle, have the exhaust system checked as soon as possible by an authorized Kia dealer.

WARNING

Engine exhaust

Do not inhale exhaust fumes or leave your engine running in an enclosed area for a prolonged time. Exhaust fumes contain carbon monoxide, a colorless and odorless gas that can cause unconsciousness and death by asphyxiation.

WARNING

Open liftgate

Do not drive with the liftgate open. Poisonous exhaust gases can enter the passenger compartment. If you must drive with the liftgate open proceed as follows:

1. Close all windows.
 2. Open side vents.
 3. Set the air intake control at "Fresh", the air flow control at "Floor" or "Face", and the fan at the highest speed.
-

Before driving

Before getting into the vehicle, you should examine the car and its surroundings. After getting into the vehicle, you should check a number of things before driving.

Before entering vehicle

- Be sure that all windows, outside mirror(s), and outside lights are clean.
- Check the condition of the tires.
- Check under the vehicle for any sign of leaks.
- Be sure there are no obstacles behind you if you intend to back up.

Necessary inspections

Fluid levels, such as engine oil, engine coolant, brake fluid, and washer fluid should be checked on a regular basis, at the exact interval depending on the fluid. Further details are provided in "Maintenance" on page 7-4.

WARNING

Distracted driving

Focus on the road while driving. The driver's primary responsibility is in the safe and legal operation of the vehicle. Use of any hand-held devices, other equipment or vehicle systems that distract the driver should not be used during vehicle operation.

Before starting

- Close and lock all doors.
- Position the seat so that all controls are easily reached.
- Buckle your seat belt.
- Adjust the inside and outside rear view mirrors.
- Be sure that all lights work.
- Check all gauges.
- Check the operation of warning lights when the ENGINE START/STOP button is turned to the ON position.
- Release the parking brake and make sure the brake warning light is not on.

For safe operation, be sure you are familiar with your vehicle and its equipment.

⚠ WARNING

When you intend to park or stop the vehicle with the engine on, be careful not to depress the accelerator pedal for a long period of time. It may overheat the engine or exhaust system and cause fire.

⚠ WARNING**Check surroundings**

Always check the surrounding areas near your vehicle for people, especially children, before putting a vehicle into D (Drive) or R (Reverse).

⚠ WARNING**Loose objects**

Securely store items in your vehicle. When you make a sudden stop or turn the steering wheel rapidly, loose objects may drop on the floor and it could interfere with the operation of the foot pedals, possibly causing an accident.

⚠ WARNING**Driving under the influence**

Do not drive while under the influence of alcohol, drugs, or other impairing substances. Drinking and driving is dangerous. Even a small amount of alcohol will affect your reflexes, perceptions and judgment. Driving while under the influence of drugs or other impairing substances is as dangerous as or more dangerous than driving drunk.

⚠ WARNING**Proper footwear**

Always wear appropriate shoes when operating your vehicle. Unsuitable shoes (high heels, ski boots, sandals, etc.) may interfere with your ability to use the brake and accelerator pedals.

Key positions (if equipped)

Your vehicle is equipped with four different ignition positions.

Illuminated ignition switch (if equipped)

Whenever a front door is opened, the ignition switch will illuminate for your convenience, provided the ignition switch is not in the ON position.



The light will go off immediately when the ignition switch is turned on. It will also go off after about 30 seconds when the door is closed.

Ignition switch position

Your vehicle is equipped with four different ignition positions.



LOCK (1)

The ignition key can be removed only in the LOCK position.

ACC (Accessory) (2)

The electrical accessories are operative. If difficulty is experienced turning the ignition switch to the ACC position, turn the key while turning the steering wheel right and left to release the tension.

ON (3)

The warning lights can be checked before the engine is started. This is the normal running position after the engine is started.

Do not leave the ignition switch ON if the engine is not running to prevent battery discharge.

START (4)

Turn the ignition switch to the START position to start the engine. The engine will crank until you release the key; then it returns to the ON position. The brake warning light can be checked in this position.

Before leaving the driver's seat, always make sure the shift lever is engaged in P (Park) for intelligent variable transmission, set the parking brake fully and shut the engine off. Unexpected and sudden vehicle movement may occur if these precautions are not taken.

⚠ WARNING**Ignition switch**

Never turn the ignition switch to LOCK or ACC while the vehicle is moving. This would result in loss of directional control and braking function, which could cause an accident.

*** NOTICE**

If you leave the ignition switch to the ACC or ON position for a long time, the battery may discharge.

⚠ WARNING**Key holder**

Do not attach small purses, multiple keys, or any other heavy accessories to the driver's key chain used to start the vehicle. This may cause the driver to accidentally make the key inserted in the vehicle to change the ignition position to the ACC position while the vehicle is moving thereby increasing the risk of an accident and causing the deactivation of several safety features.

⚠ WARNING**Leaving the Vehicle**

To avoid unexpected or sudden vehicle movement, never leave your vehicle if the transmission is not locked in the P (Park) position and the parking brake is fully engaged. Before leaving the driver's seat, always make sure the shift lever is engaged in P (Park), set the parking brake fully and shut the engine off.

Starting the engine

1. Make sure the parking brake is applied.
2. Place the transmission shift lever in P (Park). Depress the brake pedal fully.
You can also start the engine when the shift lever is in the N (Neutral) position.
3. Turn the ignition switch to START and hold it there until the engine starts (a maximum of 10 seconds), then release the key. It should be started **without depressing the accelerator**.
4. Do not wait for the engine to warm up while the vehicle remains stationary. Start driving at moderate engine speeds. (Steep accelerating and decelerating should be avoided.)

⚠ WARNING

Steering wheel

Never reach for any controls through the steering wheel while the vehicle is in motion. The presence of your hand or arm in this area could cause a loss of vehicle control.

If the engine stalls while you are in motion, do not attempt to move the shift lever to the P (Park) position. If traffic and road conditions permit, you may put the shift lever in the N (Neutral) position while the vehicle is still moving and turn the ignition switch to the START position in an attempt to restart the engine.

⚠ CAUTION

Starter

Do not engage the starter for more than 10 seconds. If the engine stalls or fails to start, wait 5 to 10 seconds before reengaging the starter. Improper use of the starter may damage it.

ENGINE START/STOP button (if equipped)

Illuminated ENGINE START/STOP button (if equipped)



The light will go off after about 30 seconds when the door is closed. It will also go off immediately when the theft-alarm system is armed.

ENGINE START/STOP button position

Your vehicle is equipped with four different ignition positions.

OFF

To turn off the engine (START/RUN position) or vehicle power (ON position), press the ENGINE START/STOP button with the shift lever in the P (Park) position. When you press the ENGINE START/STOP button without the shift lever in the P (Park) position, the ENGINE START/STOP button will not change to the OFF position but to the ACC position.

* NOTICE

You are able to turn off the engine (START/RUN) or vehicle power (ON), only when the vehicle is not in motion.

⚠ CAUTION

In an emergency situation while the vehicle is in motion, you are able to turn the engine off and to the ACC position by pressing the ENGINE START/STOP button for more than 2 seconds or 3 times repeatedly within 3 seconds.

If the vehicle is still moving, to restart the vehicle:

- Press the ENGINE START/STOP button when vehicle speed is 3 mph (5 km/h) or over.

ACC (Accessory)



Press the ENGINE START/STOP button while it is in the OFF position without depressing the brake pedal.

The steering wheel unlocks and electrical accessories are operational.

If the ENGINE START/STOP button is in the ACC position for more than 1 hour, the button is turned off automatically to prevent battery discharge.

ON

Press the ENGINE START/STOP button while it is in the ACC position without depressing the brake pedal.

The warning lights can be checked before the engine is started. Do not leave the ENGINE START/STOP button in the ON position for a long time. The battery may discharge, because the engine is not running.

START/RUN

To start the engine, depress the brake pedal and press the ENGINE START/STOP button with the shift lever in the P (Park) or the N (Neutral) position. For your safety, start the engine with the shift lever in the P (Park) position.

*** NOTICE**

If you press the ENGINE START/STOP button without pressing the brake pedal, the engine will not start and the ENGINE START/STOP button changes as follow:

OFF → ACC → ON → OFF or ACC

⚠ WARNING

- Never press the ENGINE START/STOP button while the vehicle is in motion. This would result in loss of directional control and braking function, which could cause an accident.
 - Before leaving the driver's seat, always make sure the shift lever is engaged in P (Park), set the parking brake fully and shut the engine off. Unexpected and sudden vehicle movement may occur if these precautions are not taken.
 - Never reach for the ENGINE START/STOP button or any other controls through the steering wheel while the vehicle is in motion. The presence of your hand or arm in the area could cause loss of vehicle control, an accident and serious bodily injury or death.
 - Do not place any movable objects around the driver's seat as they may move while driving, interfere with the driver and lead to an accident.
-

Starting the engine

⚠ WARNING

- Do not start the vehicle with the accelerator pedal engaged. The vehicle can move and lead to an accident.
- Wait until the engine rpm is normal. The vehicle may suddenly move if the brake pedal is released when the rpm is high.

Starting the engine

1. Make sure the smart key is located inside the vehicle and close the driver seat. The vehicle may not start if it is not located near the driver seat.
2. Make sure the parking brake is applied.
3. Make sure the shift lever is in P (Park).
 - Press the brake pedal fully. You can also start the engine when the shift lever is in the N (Neutral) position.
4. Press the ENGINE START/STOP button. Make sure that the accelerator pedal is not pressed.
5. Do not wait for the engine to warm up while the vehicle remains stationary. Start driving at moderate engine speeds. (Steep accelerating and decelerating should be avoided.)

Starting the engine with smart key

At the time that the vehicle doors are opened or when the ENGINE START/STOP button is pressed, the vehicle will check for the smart key.

If the smart key is not in the vehicle, the "🔑" indicator and a message "Key is not in the vehicle" will appear on the instrument cluster and LCD window. And if all doors are closed, the chime will sound for 5 seconds. The indicator or warning will turn off while the vehicle is moving. Always have the smart key with you.

⚠ WARNING

The engine will start, only when the smart key is in the vehicle. Never allow children or any person who is unfamiliar with the vehicle touch the ENGINE START/STOP button or related parts. Pushing the ENGINE START/STOP button while the smart key is in the vehicle may result in unintended engine activation and/or unintended vehicle movement.

⚠ CAUTION

If the engine stalls while the vehicle is in motion, do not attempt to move the shift lever to the P (Park) position. If the traffic and road conditions permit, you may put the shift lever in the N (Neutral) position while the vehicle is still moving and press the ENGINE START/STOP button in an attempt to restart the engine.

*** NOTICE**

- If the battery is weak or the smart key does not work correctly, you can start the engine by pressing the ENGINE START/STOP button with the smart key. When you press the ENGINE START/STOP button directly with the smart key, the smart key should contact the button at a right angle.



- When the stop lamp fuse is blown, you cannot start the engine normally. Replace the fuse with a new one. If it is not possible, you can start the engine by pressing the ENGINE START/STOP button for 10 seconds while it is in the ACC position. The engine can start without pressing the brake pedal. But for your safety, always press the brake pedal before starting the engine.

⚠ CAUTION

Do not press the ENGINE START/STOP button for more than 10 seconds, except when the stop lamp fuse is blown.

Vehicle Auto Shut-off system (if equipped)

The vehicle auto shut-off system is designed to automatically shut off the vehicle after a certain time the driver sets to reduce fuel consumption and energy consumption of the vehicle and to prevent carbon monoxide (CO) poisoning.

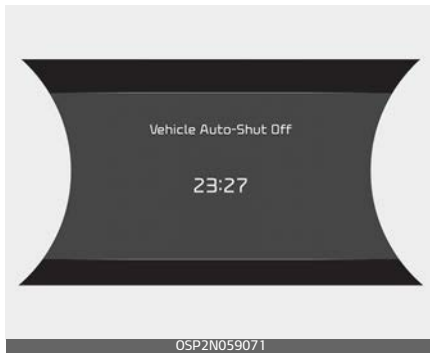

Prerequisite for activation

This system can be activated, when the following all prerequisites are satisfied.

- The ignition switch is ON.
- The transmission is in the P (Park) position.
- The vehicle stops.
- The vehicle speed is under 2 mph (3 km/h).
- The driver's seat belt is unfastened.
- The door is opened.
- The passenger's seat is not occupied.

Setting Shut-off Time

The driver can set the shut-off time on the cluster LCD display or the infotainment system screen (if equipped).

The option can be found under the following menu:

1. Press the MODE button (⏏) several times on the steering wheel until 'User Settings' menu appears on the LCD display.
2. Select 'Convenience → Vehicle Auto-Shut Off → 60 min./30 min./Disable' with the MOVE switch (↖ / ↘) and the OK button on the steering wheel.

If your vehicle is equipped with the infotainment system, the option can be found under the following menu:

1. Press 'Settings' button of the Infotainment system.
2. Select 'Vehicle Setting → Convenience → Vehicle Auto-Shut Off → 60min/30min/Off' on the infotainment system screen.

* NOTICE

- The default setting will be retained until the timer is reset.
- The timer will revert back to the previous setting at the next startup if the driver selects 'Disable' in the User Settings mode.

* NOTICE

- The default setting is 30 minutes.

Resetting the time

The system can be initialized and restarted under the following conditions:

- When pressing and releasing the brake pedal.
- When the accelerator pedal is depressed.
- When the driver manually resets the timer.
- When the driver manually press the OK button on the steering wheel.

Canceling the Vehicle Auto Shut-off system

The system will be canceled automatically when:

- The vehicle speed is over 2 mph (3 km/h).
- The vehicle is shifted to D (Drive), R (Reverse) or N (Neutral).
- The driver's seat belt is fastened.



All Wheel Drive (AWD) system (if equipped)

The All Wheel Drive (AWD) system delivers engine power to front and rear wheels for maximum traction.

AWD is useful when extra traction is required, such as when driving slippery, muddy, wet, or snow-covered roads.

If the system determines there is a need for four wheel drive, the engine's driving power will be distributed to all four wheels automatically.

⚠ WARNING

If the AWD warning light () stays on the instrument cluster, your vehicle may have a malfunction with the AWD system. When the AWD warning light () illuminates, have your vehicle checked by an authorized Kia dealer as soon as possible.

⚠ WARNING

To reduce the risk of **SERIOUS INJURY** or **DEATH**:

- Do not drive in conditions that exceed the vehicle's intended design, such as challenging off-road conditions.
- Avoid high speeds when cornering or turning.
- Do not make quick steering wheel movements, such as sharp lane changes or fast, sharp turns.
- The risk of a rollover is greatly increased if you lose control of your vehicle at highway speeds.
- Loss of control often occurs if two or more wheels drop off the roadway and the driver over steers to reenter the roadway.
- In the event your vehicle leaves the roadway, do not steer sharply. Instead, slow down before pulling back into the travel lanes.



AWD mode

AWD helps the vehicle's performance by controlling 4 wheels.



You can switch from AWD AUTO mode to AWD Lock mode by pressing AWD Lock mode switch.

AWD transfer mode selection

Transfer mode	Selection button	Indicator light	Description
AWD AUTO	-		<ul style="list-style-type: none"> • AWD AUTO is used when driving on roads in normal conditions, roads in urban areas, and on highways. • All wheels are in operation when a vehicle travels at a constant speed. Required tractions are applied on front and rear wheels vary depending on road and driving conditions, which will be automatically controlled by the computing system. • When the cluster's AWD Auto display mode is selected, the cluster displays the status of how four wheel's traction forces are distributed.
AWD LOCK			<ul style="list-style-type: none"> • The main goal of AWD Lock mode is to allow a driver to maximize the vehicle's traction under extreme driving conditions, such as unpaved off-road, sandy roads, and muddy roads. • AWD Lock mode is in operation only when a vehicle travels at 38 mph (60 km/h) or less. When traveling at 38 mph (60 km/h) or faster, the mode will switch to AWD Auto. When traveling at 38 mph (60 km/h) or less, the mode will switch back to AWD Lock. • When AWD Lock mode illuminates, the cluster does not display the front/rear wheel traction force distribution status. • Press the AWD Lock mode switch again to switch back to AWD Auto.

*** NOTICE**

Normal road conditions

- Maintain AWD Auto mode when driving on roads in normal conditions.
- When driving under normal road conditions (especially when cornering) in AWD Lock mode, a driver may find minor mechanical vibration or noise, which is an extremely normal phenomenon, not a malfunction. When AWD Lock mode is released, such noise or vibration will be immediately gone.

For safe All Wheel Drive (AWD) operation

⚠ WARNING

All Wheel Drive

The conditions of on-road or off-road that demand All Wheel Drive means all functions of your vehicle is exposed to extreme stress than under normal road conditions. Slow down and be ready for changes in the composition and traction of the surface under your tires. If you have any doubt about the safety of the conditions you are facing, stop and consider the best way to proceed.

- Do not try to drive in deep standing water or mud since such conditions can stall your engine and clog your exhaust pipes. Do not drive down steep hills since it requires extreme skill to maintain control of the vehicle.

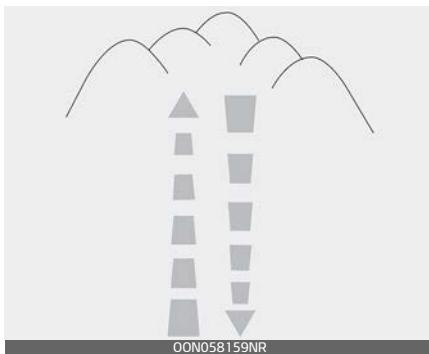

- When you are driving up or down hills drive as straight as possible. Use extreme caution in going up

or down steep hills, since you may flip your vehicle over depending on the grade, terrain and water/mud conditions.



⚠ WARNING

Hills

Driving across the contour of steep hills can be extremely dangerous. This danger can come from slight changes in the wheel angle, which can destabilize the vehicle or, even if the vehicle is maintaining stability under power, it can lose that stability if the vehicle stops its forward motion. Your vehicle may roll over without warning and without time for you to correct a mistake that could cause serious injury or death.

- You must learn how to corner in a AWD vehicle. Do not rely on your experience in conventional FWD vehicles when cornering the vehicle in AWD mode. For starters, you must drive slower in AWD.

⚠ WARNING**All Wheel Drive (AWD)**

Reduce speed when you turn corners. The center of gravity of AWD vehicles is higher than that of conventional FWD vehicles, making them more likely to roll over when you turn corners too fast.

⚠ WARNING**Steering wheel**

Do not grab the inside of the steering wheel when you are driving on unpaved roads. You may hurt your arm by a sudden steering maneuver or from steering wheel rebound due to impact with objects on the ground. You could lose control of the steering wheel.

- Always hold the steering wheel firmly when you are driving on unpaved roads.
- Make sure all passengers are wearing seat belts.

⚠ WARNING**Wind danger**

If you are driving in heavy wind, drive more slowly, as the vehicle's higher center of gravity decreases your steering control capacity.

- If you need to drive in the water, stop your vehicle, set your transfer to the AWD LOCK mode and drive at less than 5 mph (8 km/h).

⚠ WARNING**Driving through water**

Drive slowly. If you are driving too fast in water, the water can get into the engine compartment and wet the ignition system, causing your vehicle to suddenly stop. If this happens and your vehicle is in a tilted position, your vehicle may roll over.

*** NOTICE**

- Do not drive in water if the level is higher than the bottom of the vehicle.
- Check your brake condition once you are out of mud or water. Press the brake pedal several times as you move slowly until you feel normal braking forces return.
- Shorten your scheduled maintenance interval if you drive in offroad conditions, such as sand, mud or water (refer to "Maintenance Under Severe Usage Conditions – Non Turbo Models" on page 7 - 14). Always wash your vehicle thoroughly after off-road use, especially the bottom of the vehicle.

- Since the driving torque is always applied to the 4 wheels the performance of the AWD vehicle is greatly affected by the condition of the tires. Be sure to equip the vehicle with four tires of the same size and type.
- A full time All Wheel Drive vehicle cannot be towed by an ordinary tow truck. Make sure that the vehicle is placed on a flat bed truck for moving.

⚠ WARNING

All Wheel Drive (AWD) driving

- Avoid high cornering speed.
- Do not make quick steering wheel movements, such as sharp lane changes or fast, sharp turns.
- The risk of rollover is greatly increased if you lose control of your vehicle at high speed.
- In a collision, an unbelted person is significantly more likely to die compared to a person wearing a seat belt.
- Loss of control often occurs if two or more wheels drop off the roadway and the driver over-steers to re-enter the roadway. In the event your vehicle leaves the roadway, do not steer sharply. Instead, slow down before pulling back into the travel lanes.

⚠ CAUTION

Mud or snow

If one of the front or rear wheels begins to spin in mud, snow, etc. the vehicle can sometimes be driven out by engaging the accelerator pedal further; however avoid running the engine continuously at high rpm because doing so could damage the AWD system.

Driving in sand or mud

- Maintain slow and constant speed. Operate the accelerator pedal slowly to ensure safe driving (wheel-slip prevention).
- Use tire chains driving in mud if necessary.
- Keep sufficient distance between your vehicle and the vehicle in front of you.
- Reduce vehicle speed and always check the road condition.
- Avoid speeding, rapid acceleration, sudden brake applications, and sharp turns to prevent getting stuck.
- When the vehicle is stuck in snow, sand or mud, the tires may not operate.
- This is to protect the transmission and not a malfunction.

* NOTICE

Moving the car forcibly to get out of mud or sand can cause damage/overheat of the engine or damage/breakdown of the transaxle, differential or AWD system as well as damage to tires. If excessive wheel slip occurs after entering a sandy/muddy road, the vehicle may fall into the sand/mud. When this happens, put a stone or a tree branch under the tire, and then try to pull out the car, or try to get it unstuck by repeatedly moving forwards and backwards.

⚠ WARNING

Your vehicle is equipped with tires designed to provide safe riding and handling capability. Do not use tires and wheels that are different in size and type from the originally installed ones. It can affect the safety and performance of your vehicle, which could lead to steering failure or rollover and serious injury. When replacing the tires, be sure to equip all four tires with the tire and wheel of the same size, type, tread, brand and load-carrying capacity.

⚠ WARNING

Jacked vehicle

While the full-time AWD vehicle is being raised on a jack, never start the engine or cause the tires to rotate.

There is the danger that rotating tires touching the ground could cause the vehicle to go off the jack and to jump forward.

- Full-time AWD vehicles must be tested on a special four wheel chassis dynamometer.

* NOTICE

Never engage the parking brake while performing these tests.

- A full-time AWD vehicle should not be tested on a FWD roll tester. If a FWD roll tester must be used, perform the following:

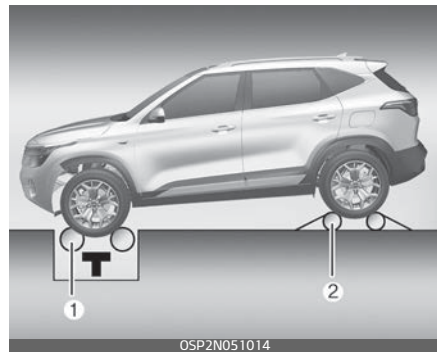

1. Place the front wheels on the roll tester (1) for a speedometer test as shown in the illustration.
2. Release the parking brake.
3. Place the rear wheels on the temporary free roller (2) as shown in the illustration.

⚠ WARNING

Dynamometer testing

Keep away from the front of the vehicle while the vehicle is in gear on the dynamometer. This is very dangerous as the vehicle can jump forward and cause serious injury or death.

⚠ CAUTION

- When lifting up the vehicle, do not operate front and rear wheels separately. All four wheels should be operated.
- If you need to operate the front wheel and rear wheels when lifting up the vehicle, you should release the parking brake.

Dual clutch transmission (DCT) (if equipped)

The dual clutch transmission has 7 forward speeds and one reverse speed.

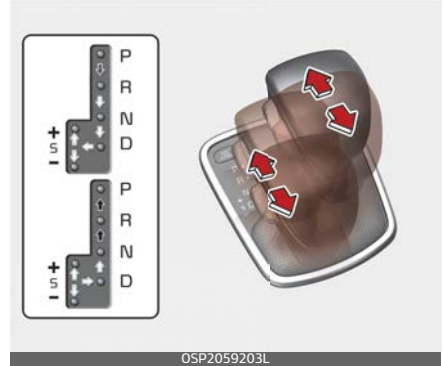

➡ Press the brake pedal and the lock release button when shifting.

➡ Press the lock release button when shifting.

⇔ The shift lever can be shifted freely.

* To move the shift lever from/to P (Parking) or between R (Reverse) and D (Drive), you must depress the brake pedal for the vehicle to stand still.

Dual clutch transmission operation

The individual speeds are selected automatically in the D (Drive) position.

WARNING

To reduce the risk of serious injury or death:

- ALWAYS check the surrounding areas near your vehicle for people, especially children, before shifting a vehicle into D (Drive) or R (Reverse).
 - Before leaving the driver's seat, always make sure the shift lever is in the P (Park) position, then set the parking brake, and place the ignition switch in the LOCK/OFF position. Unexpected and sudden vehicle movement can occur if these precautions are not followed.
 - When using Manual Shift Mode, use caution when shifting from a higher gear to a lower gear on slippery roads. This could cause the tires to slip and may result in an accident.
 - To avoid damage to your transmission, do not try to accelerate with the shift lever in R (Reverse) or any forward gear position with the brake engaged.
 - When stopped on a slope, do not hold the vehicle with accelerator pedal. Engage the service brake or the parking brake.
-
- The Dual Clutch Transmission gives the driving feel of a manual transmission, yet provides the ease of a fully automatic transmission. Unlike a traditional automatic transmission, the gear shifting can be felt (and heard) on the dual clutch transmission.
 - Think of it as an automatically shifting manual transmission.
 - Shift into Drive range and get fully automatic shifting, similar to a conventional automatic transmission.
 - Dual clutch transmission adopts dry-type dual clutch, which is different from torque converter of automatic transmission, and shows better acceleration performance during driving. But, initial launch might be little bit slower than Automatic Transmission.
 - The dry-type clutch transfers torque and provides a direct driving feeling which may feel different from a conventional automatic transmission with a torque converter. This may be more noticeable when starting from a stop or low vehicle speed.

- When rapidly accelerating at low vehicle speed, engine could rev at high rpm depending on vehicle drive condition.
- For smooth launch uphill, press down the accelerator pedal smoothly depending on the current conditions.
- If you release your foot from the accelerator pedal at low vehicle speed, you may feel strong engine brake, which is similar to manual transmission.
- When driving downhill, you may use Sports Mode to downshift to a lower gear in order to control your speed without using the brake pedal excessively.
- When you turn the engine on and off, you may hear clicking sounds as the system goes through a self test. This is a normal sound for the Dual Clutch Transmission.
- Always come to a complete stop before shifting into D (Drive) or R (Reverse).
- Do not put the shift lever in N (Neutral) while driving.

⚠ WARNING

Due to transmission failure, the vehicle may not move and the position indicator (D, R) will blink on the cluster. In this case, have the system checked by an authorized Kia dealer.

LCD display for transmission temperature and warning message

The LCD displays the transmission temperature. A warning message is displayed on the LCD when transmission is overheated or in a warning condition.

Transmission temperature gauge

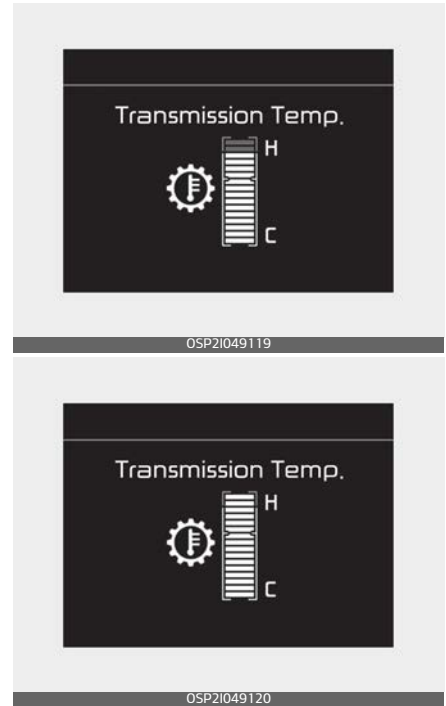

- Try to drive so that the temperature gauge do not show high/overheat. When the transmission is overheated, the warning message will display on the LCD. Follow the displayed message.

- The transmission temperature is displayed in three colors (white, orange and red) as it increases. (if equipped with the color type cluster) if equipped with the mono type cluster. temperature gauge is displayed in one color (white).
- Orange temperature gauge is displayed right before the warning message appears on the LCD display. (if equipped)

CAUTION

- Increase (high temperature) of the transmission temperature gauge usually appears on an incline when the vehicle is stopped for a long time using accelerator pedal, without depressing the brake pedal.
- To maintain the optimal transmission performance, drive so that the white gauge is not exceeded.

Normal (below marking 10)

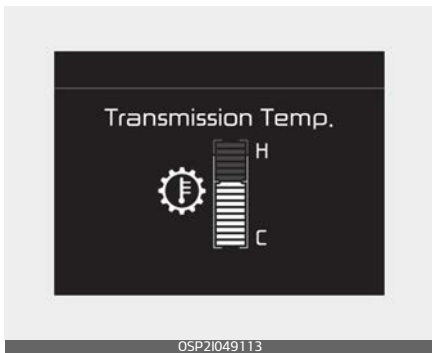

OSP21049113

- In order to maintain the optimal gear shift performance, drive so that the temperature gauge is below the point (**below marking10**).

*** NOTICE**

The temperature gauge may increase rapidly if clutch slip occurs excessively due to repeated stop-and-go driving on steep grades and when Hill Hold is maintained for a long time. In order to prevent excessive temperature increase, use the brake during low speed driving or when stopping the vehicle on a hill.

Before entering High/Overheat (from marking 10 to 14)

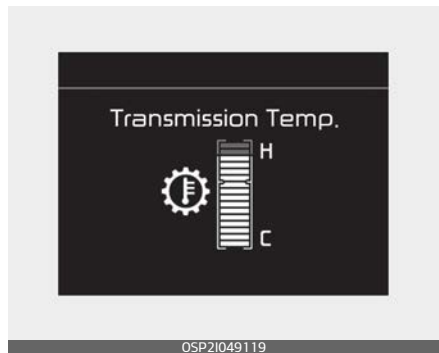

OSP21049119

- This zone shows that the dual clutch temperature of the DCT is before entering the high/overheat zone. When the clutch temperature is within this zone (from marking 10 to 14), drive minimizing the clutch slip so that the

temperature gauge is below the point (**marking 10**).

- If the dual clutch temperature continues to increase and reaches marking 14, the warning alarm sounds and the temperature gauge pops up on the cluster. The DCT warning message is not displayed.

High/Overheat (from marking 15 to 16)

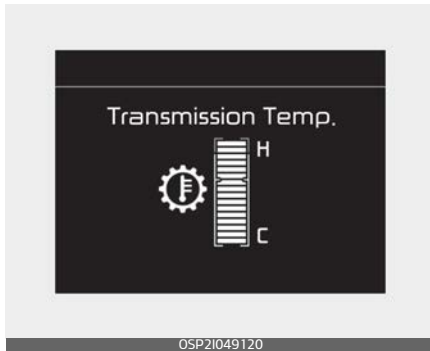

- This zone shows that the dual clutch temperature of the DCT has entered the high/overheat zone. The DCT warning alarm sounds, warning message is displayed on the cluster and the temperature gauge disappears from the cluster. **Follow the displayed warning message.**
- To check the temperature status of the dual clutch when overheated, move to the temperature gauge screen by selecting the trip computer mode. Then, you can

check the temperature status of the dual clutch.

DCT warning messages

This warning message is displayed when vehicle is driven slowly on a grade and the vehicle detects that the brake pedal is not applied.

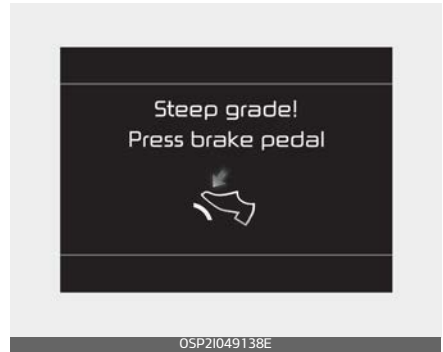

Steep grade

Driving up hills or on steep grades:

- To hold the vehicle on an incline use the foot brake or the parking brake.
- When in stop-and-go traffic on an incline, keep some distance ahead before moving the vehicle forward. Then hold the vehicle on the incline with the foot brake.
- If the vehicle is held on a hill by applying the accelerator pedal or by creeping with brake pedal disengaged, the clutch and transmission may overheat which can result in damage. At this time, a warning message will appear on the LCD display.

- Ignoring the warnings can lead to damage to the transmission.

Transmission high temperature

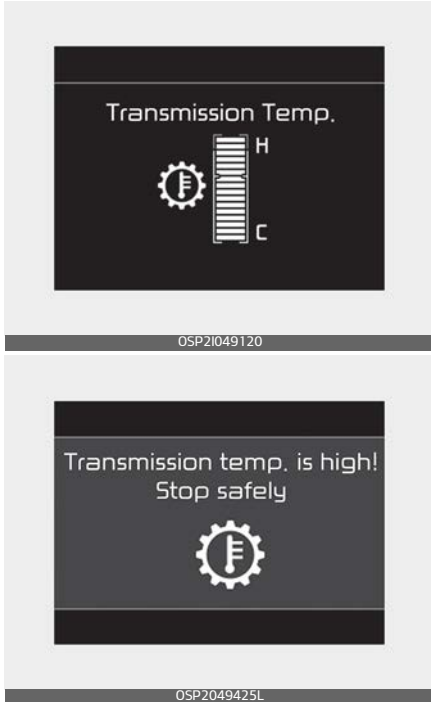

- Under certain conditions, such as repeated stop-and-go launches on steep grades, sudden take off or acceleration, or other harsh driving conditions, the transmission clutch temperatures will increase excessively. Finally, the clutch in transmission could be overheated.
- If this occurs, pull over to a safe location, stop the vehicle with the engine running, apply the brakes and shift the vehicle to P (Park),

- and allow the transmission to cool.
- If you ignore this warning, the driving condition may become worse. You may experience abrupt shifts, frequent shifts, or jerkiness. To return to the normal driving condition, stop the vehicle and apply the foot brake or shift into P (Park). Then allow the transmission to cool for a few minutes with engine on, before driving off.
- When possible, drive the vehicle smoothly.

Transmission overheated

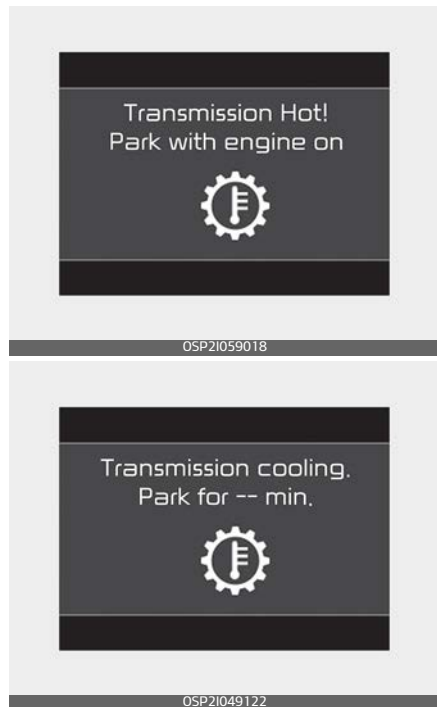

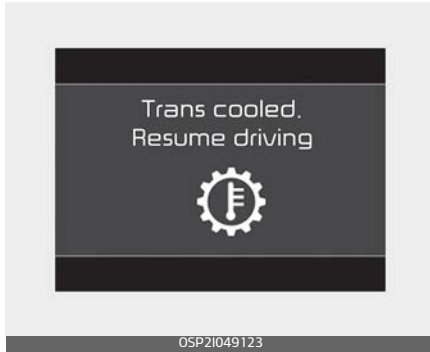

- The warning will display a time to wait for the transmission to cool.
- If this occurs, pull over to a safe location, stop the vehicle with the engine running, apply the brakes and shift the vehicle to P (Park), and allow the transmission to cool.
- When the message "Trans cooled. Resume driving." appears you can continue to drive your vehicle.
- When possible, drive the vehicle smoothly.

If any of the warning messages in the LCD display continue to blink, for your safety, you should have the system checked by an authorized Kia dealer.

Transmission ranges

The indicator in the instrument cluster displays the shift lever position when the ignition switch is in the ON position.

P (Park)

Always come to a complete stop before shifting into P (Park).

To shift from P (Park), you must depress firmly on the brake pedal and make sure your foot is off the accelerator pedal.

The shift lever must be in P (Park) before turning the engine off.

⚠ WARNING

- Shifting into P (Park) while the vehicle is in motion may cause you to lose control of the vehicle.
- After the vehicle has stopped, always make sure the shift lever is in P (Park), apply the parking brake, and turn the engine off.
- Do not use the P (Park) position in place of the parking brake.

R (Reverse)

Use this position to drive the vehicle backward.

⚠ CAUTION

Always come to a complete stop before shifting into or out of R (Reverse); you may damage the transmission if you shift into R (Reverse) while the vehicle is in motion.

N (Neutral)

The wheels and transmission are not engaged.

⚠ WARNING

Do not shift into gear unless your foot is firmly on the brake pedal. Shifting into gear when the engine is running at high speed can cause the vehicle to move very rapidly. You could lose control of the vehicle and hit people or objects.

⚠ WARNING

Do not drive with the shift lever in N (Neutral).

The engine brake will not work and may lead to an accident.

⚠ CAUTION

- Always park the vehicle in P (Park) for safety and engage the parking brake.

Parking in N (Neutral) gear

Follow the steps below when you are parking and want the vehicle to move when pushed.

1. After parking your vehicle, step on the brake pedal and move the shift lever to "P" with the ignition button in "ON" or while the engine is running.
2. If the parking brake is applied unlock the parking brake.
 - For EPB (Electronic Parking Brake) equipped vehicles, push the brake pedal with the ignition button in "ON" or while the engine is running to disengage the parking brake. If AUTO HOLD function is used while driving (if "AUTO HOLD" indicator is on in the cluster), press "AUTO HOLD" switch and "AUTO HOLD" function should be turned off.
3. While pressing the brake pedal, turn the ignition button "OFF".
 - For smart key equipped vehicles, the ignition switch can be moved to "OFF" only when the shift lever is in "P".
4. Change the gear shift lever to "N" (Neutral) while pressing the brake pedal and pushing "SHIFT LOCK RELEASE" button or inserting, pressing down a tool (e.g., flat-head screw-driver) into the "SHIFT LOCK RELEASE" access hole at the same time. Then the vehicle will move when external force is applied.

⚠ CAUTION

- With the exception of parking in neutral gear, always park the vehicle in "P" (Park) for safety and engage the parking brake.

- Before parking in "N" (Neutral) gear, first make sure the parking ground is level and flat. Do not park in "N" gear on any slopes or gradients.
If parked and left in "N", the vehicle may move and cause serious damage and injury.
- After the ignition switch has been turned off, the electronic parking brake cannot be disengaged.
- For EPB (Electronic Parking Brake) equipped vehicles with AUTO HOLD function used while driving, if the ignition button has been turned "OFF", the electronic parking brake will be engaged automatically. Therefore, AUTO HOLD function should be turned off before the ignition button is turned off.

D (Drive)

This is the normal driving position. The transmission will automatically shift through a 7 gear sequence, providing the best fuel economy and power.

For extra power when passing another vehicle or driving uphill depress the accelerator pedal further until you feel the transmission downshift to a lower gear.

To stop the vehicle during driving, please press brake pedal fully to prevent unintended movement.

Sports mode

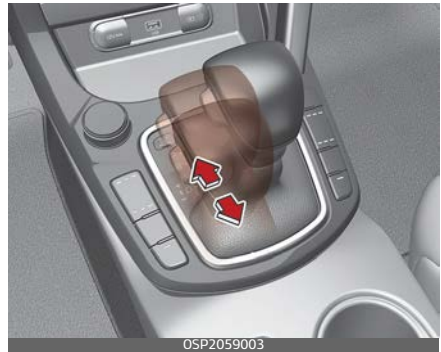

Whether the vehicle is stationary or in motion, sports mode can be selected by pushing the shift lever from the D (Drive) position into the manual gate. To return to D (Drive) range operation, push the shift lever back into the main gate.

In sports mode, moving the shift lever backwards and forwards will allow you to select the desired range of gears for the current driving conditions.

- Up (+): Push the lever forward once to shift up one gear.
- Down (-): Pull the lever backwards once to shift down one gear.

*** NOTICE**

- Only the 7 forward gears can be selected in sports mode. To reverse or park the vehicle, move the shift lever to the R (Reverse) or P (Park) position as required, and only when the vehicle is stopped and not moving.

- Downshifts are made automatically when the vehicle slows down. When the vehicle stops, 1st gear is automatically selected.
- When the engine rpm approaches the red zone the transmission will upshift automatically.
- If the driver presses the lever to + (Up) or - (Down) position, the transmission may not make the requested gear change if the next gear is outside of the allowable engine rpm range. The driver must execute upshifts in accordance with road conditions, taking care to keep the engine rpms below the red zone.

Shift lock system

For your safety, the Dual clutch transmission has a shift lock system which prevents shifting the transmission from P (Park) into R (Reverse) unless the brake pedal is depressed.

To shift the transmission from P (Park) into R (Reverse):

1. Depress and hold the brake pedal.
2. Start the engine or turn the ignition switch to the ON position.
3. Move the shift lever.

If the brake pedal is repeatedly depressed and released with the shift lever in the P (Park) position, a chattering noise & vibration near

the shift lever may be heard. This is a normal condition.

⚠ WARNING

Always fully depress the brake pedal before and while shifting out of the P (Park) position into another position to avoid inadvertent motion of the vehicle which could injure persons in or around the vehicle.

Overriding the shift lock

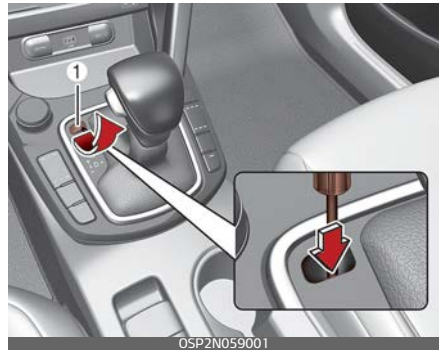

If the shift lever cannot be moved from the P (Park) position into R (Reverse) position with the brake pedal depressed, continue depressing the brake, and then do the following:

1. Place the ignition switch in the LOCK/OFF position.
2. Apply the parking brake.
3. Carefully remove the cap covering (1) the shift-lock release access hole.

4. Insert a tool (e.g., flathead screwdriver) into the access hole and press down on the tool.
 5. Move the shift lever.
 6. Remove the tool from the shift-lock override access hole then install the cap.
 7. Have your vehicle inspected by an authorized Kia dealer immediately.
- Always use the parking brake. Do not depend on placing the transmission in P (Park) to keep the car from moving.
 - Optimum vehicle performance and economy is obtained by smoothly depressing and releasing the accelerator pedal.

WARNING

Good driving practices

- Never move the shift lever from P (Park) or N (Neutral) to any other position with the accelerator pedal depressed.
 - Never move the shift lever into P (Park) when the vehicle is in motion.
 - Be sure the car is completely stopped before you attempt to shift into R (Reverse) or D (Drive).
 - Never take the car out of gear and coast down a hill. This may be extremely hazardous. Always leave the car in gear when moving.
 - Do not "ride" the brakes. This can cause them to overheat and malfunction. Instead, when you are driving down a long hill, slow down and shift to a lower gear. When you do this, engine braking will help slow the car.
 - Slow down before shifting to a lower gear. Otherwise, the lower gear may not be engaged.
- When driving uphill or downhill, always shift to D (Drive) for driving forward or shift to R (Reverse) for driving backwards, and check the gear position indicated on the cluster before driving. Driving in the opposite direction of the selected gear can lead to a dangerous situation by shutting off the engine and affecting the braking performance.
 - Always buckle-up! In a collision, an unbelted occupant is significantly more likely to be seriously injured or killed than a properly belted occupant.
 - Avoid high speeds when cornering or turning.
 - Do not make quick steering wheel movements, such as sharp lane changes or fast, sharp turns.
 - The risk of rollover is greatly increased if you lose control of your vehicle at highway speeds.
 - Loss of control often occurs if two or more wheels drop off the road-

way and the driver oversteers to reenter the roadway.

- In the event your vehicle leaves the roadway, do not steer sharply. Instead, slow down before pulling back into the travel lanes.
- Never exceed posted speed limits.

⚠ WARNING

If your vehicle becomes stuck in snow, mud, sand, etc., then you may attempt to rock the vehicle free by moving it forward and backward. Do not attempt this procedure if people or objects are anywhere near the vehicle. During the rocking operation the vehicle may suddenly move forward or backward as it becomes unstuck, causing injury or damage to nearby people or objects.

Intelligent variable transmission (IVT) (if equipped)

The Intelligent Variable Transmission (IVT) automatically shifts depending on speed, accelerate pedal position. The individual speeds are selected automatically, depending on the position of the shift lever.

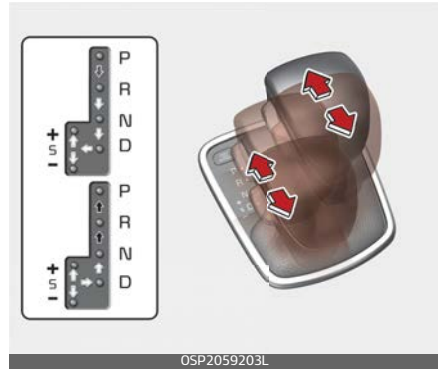

➡ Depress the brake pedal and the lock release button when shifting.

➡ Press the lock release button when shifting.

⇨ The shift lever can be shifted freely.

Intelligent Variable Transmission (IVT) operation

For smooth operation, depress the brake pedal when shifting from N (Neutral) to a forward or reverse gear.

⚠ WARNING

Intelligent Variable Transmission (IVT)

- Always check the surrounding areas near your vehicle for people, especially children, before shifting a car into D (Drive) or R (Reverse).
- Before leaving the driver's seat, always make sure the shift lever is in the P (Park) position; then set the parking brake fully and shut the engine off. Unexpected and sudden vehicle movement can occur if these precautions are not followed in the order identified.
- Do not use the engine brake (shifting from a high gear to lower gear) rapidly on slippery roads.
The vehicle may slip causing an accident.

⚠ CAUTION

- To avoid damage to your transmission, do not accelerate the engine in R (Reverse) or any forward gear position with the brakes on.
- When stopped on an incline, do not hold the vehicle stationary with engine power. Use the service brake or the parking brake.
- Do not shift from N (Neutral) or P (Park) into D (Drive) or R (Reverse) when the engine is above idle speed.

LCD display for warning message

A warning message is displayed on the LCD in a warning condition.

Transmission overheated



- When driving under severe conditions such as repeated sudden starts and sudden acceleration, the transmission may overheat, and a warning sound and a warn-

ing message appear on the instrument cluster due to the self-protection mode.

- If this occurs, pull over to a safe location, stop the vehicle with the engine running, apply brakes and shift the gear to P (Park), and allow the transmission to cool.
- If the warning message continues to appear, have the system checked by an authorized Kia dealer to prevent unexpected accidents.

Vehicle power limited



- If the transmission continues to drive overheating and reaches its maximum temperature, the above warning message appears. In this case, the vehicle limits transmission power by its self-protection mode.
- When such a situation occurs, normal driving is restricted until the transmission goes down to normal temperature, so after moving the vehicle to a safe place,

shift the gear to P (Park) with the engine running and wait several minutes until the warning on the screen disappears.

- If the warning message continues to appear, have the system checked by an authorized Kia dealer to prevent unexpected accidents.

Transmission cooled

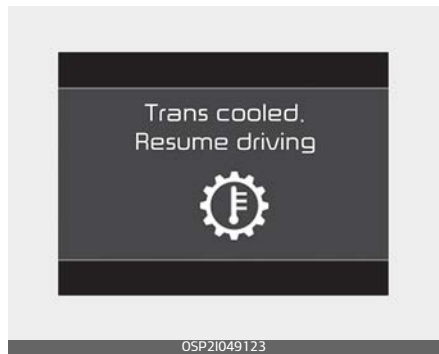

- When the message "Trans cooled. Resume driving" appears you can continue to drive your vehicle.

Transmission ranges

The indicator in the instrument cluster displays the shift lever position when the ignition switch is in the ON position.

P (Park)

Always come to a complete stop before shifting into P (Park). This position locks the transmission and

prevents the front wheels from rotating.

⚠ WARNING

- Shifting into P (Park) while the vehicle is in motion will cause the drive wheels to lock which will cause you to lose control of the vehicle.
- Do not use the P (Park) position in place of the parking brake. Always make sure the shift lever is latched in the P (Park) position and set the parking brake fully.
- Never leave a child unattended in a vehicle.

⚠ CAUTION

The transmission may be damaged if you shift into P (Park) while the vehicle is in motion.

R (Reverse)

Use this position to drive the vehicle backward.

⚠ CAUTION

Always come to a complete stop before shifting into or out of R (Reverse); you may damage the transmission if you shift into R while the vehicle is in motion, except as explained in "Rocking the vehicle" on page 5-183.

N (Neutral)

The wheels and transmission are not engaged. The vehicle will roll freely even on the slightest incline unless the parking brake or service brakes are applied.

⚠ WARNING

Do not drive with the shift lever in N (Neutral).

The engine brake will not work and may lead to an accident.

⚠ CAUTION

- Always park the vehicle in "P" (Park) for safety and engage the parking brake.

Parking in N (Neutral) gear

Follow below steps when parking and you want the vehicle to move when pushed.

1. After parking your vehicle, step on the brake pedal and move the shift lever to "P" with the ignition button in "ON" or while the engine is running.
2. If the parking brake is applied unlock the parking brake.
 - For EPB (Electronic Parking Brake) equipped vehicles, push the brake pedal with the ignition button in "ON" or while the engine is running to disengage

the parking brake. If AUTO HOLD function is used while driving (If "AUTO HOLD" indicator is on in the cluster), press "AUTO HOLD" switch and "AUTO HOLD" function should be turned off.

3. While pressing the brake pedal, turn the ignition button "OFF".
 - For smart key equipped vehicles, the ignition switch can be moved to "OFF" only when the shift lever is in "P".
4. Change the gear shift lever to "N" (Neutral) while pressing the brake pedal and pushing "SHIFT LOCK RELEASE" button or inserting, pressing down a tool (e.g., flat-head screw-driver) into the "SHIFT LOCK RELEASE" access hole at the same time. Then, the vehicle will move when external force is applied.

CAUTION

- With the exception of parking in neutral gear, always park the vehicle in "P" (Park) for safety and engage the parking brake.
- Before parking in "N" (Neutral) gear, first make sure the parking ground is level and flat. Do not park in "N" gear on any slopes or gradients.
If parked and left in "N", the vehicle may move and cause serious damage and injury.

- After the ignition switch has been turned off, the electronic parking brake cannot be disengaged.
- For EPB (Electronic Parking Brake) equipped vehicles with AUTO HOLD function used while driving, if the ignition button has been turned "OFF", the electronic parking brake will be engaged automatically. Therefore, AUTO HOLD function should be turned off before the ignition button is turned off.

D (Drive)

This is the normal forward driving position. The transmission will automatically shift, providing the best fuel economy and power.

For extra power when passing another vehicle or climbing grades, depress the accelerator fully, at which time the transmission will automatically downshift to the next lower gear.

NOTICE

Always come to a complete stop before shifting into D (Drive).

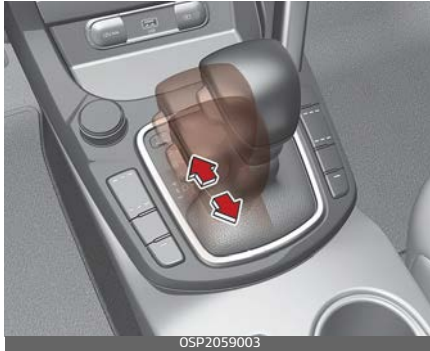
Sports mode

Whether the vehicle is stationary or in motion, sports mode can be selected by pushing the shift lever from the D (Drive) position into the manual gate. To return to D (Drive) range operation, push the shift lever back into the main gate.

SPORT mode manages the driving dynamics by automatically adjusting the steering effort, and the engine and transmission control logic for enhanced driver performance.

In sports mode, moving the shift lever backwards and forwards will allow you to select the desired range of gears for the current driving conditions.

- Up (+): Push the lever forward once to shift up one gear.
- Down (-): Pull the lever backwards once to shift down one gear.

*** NOTICE**

- In sports mode, the driver must execute upshifts in accordance with road conditions, taking care to keep the engine speed below the red zone.
- In sports mode, only the 8 forward gears can be selected. To reverse or park the vehicle, move the shift lever to the R (Reverse) or P (Park) position as required.
- In sports mode, downshifts are made automatically when the vehicle slows down. When the vehicle stops, 1st gear is automatically selected.
- In sports mode, when the engine rpm approaches the red zone shift points are varied to upshift automatically.
- To maintain the required levels of vehicle performance and safety, the system may not execute certain gearshifts when the shift lever is operated.
- When driving on a slippery road, push the shift lever forward into the + (up) position. This causes the transmission to shift into the 2nd gear which is better for smooth driving on a slippery road. Push the shift lever to the - (down) side to shift back to the 1st gear.
- When SPORT mode is activated:
 - The engine rpm will tend to remain raised over a certain

length of time even after releasing the accelerator.

- Upshifts are delayed when accelerating.
- In SPORT mode, the fuel efficiency may decrease.

Shift lock system

For your safety, the Intelligent Variable Transmission (IVT) has a shift lock system which prevents shifting the transmission from P (Park) into R (Reverse) unless the brake pedal is depressed.

To shift the transmission from P (Park) into R (Reverse):

1. Depress and hold the brake pedal.
2. Start the engine or turn the ignition switch to the ON position.
3. Move the shift lever.

If the brake pedal is repeatedly depressed and released with the shift lever in the P (Park) position, a chattering noise near the shift lever may be heard. This is a normal condition.

⚠ WARNING

Always fully depress the brake pedal before and while shifting out of the P (Park) position into another position to avoid inadvertent motion of the vehicle which could injure persons in or around the vehicle.

Overriding the shift lock

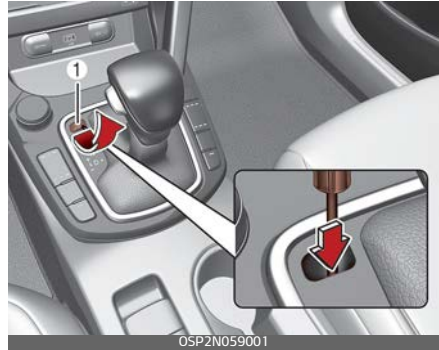

If the shift lever cannot be moved from the P (Park) position into R (Reverse) position with the brake pedal depressed, continue depressing the brake, and then do the following:

1. Place the ignition switch in the LOCK/OFF position.
2. Apply the parking brake.
3. Carefully remove the cap covering (1) the shift-lock release access hole.
4. Insert a tool (e.g., flathead screwdriver) into the access hole and press down on the tool.
5. Move the shift lever.
6. Remove the tool from the shift-lock override access hole then install the cap.
7. Have your vehicle inspected by an authorized Kia dealer immediately.

Good driving practices

- Never move the shift lever from P (Park) or N (Neutral) to any other position with the accelerator pedal depressed.
- Never move the shift lever into P (Park) when the vehicle is in motion.
- Be sure the vehicle is completely stopped before you attempt to shift into R (Reverse) or D (Drive).
- Never take the vehicle out of gear and coast down a hill. This may be extremely hazardous. Always leave the vehicle in gear when moving.
- Do not "ride" the brakes. This can cause them to overheat and malfunction. Instead, when you are driving down a long hill, slow down and shift to a lower gear. When you do this, engine braking will help slow down the vehicle.
- Always use the parking brake. Do not depend on placing the transmission in P (Park) to keep the vehicle from moving.

WARNING

Exercise extreme caution when driving on a slippery surface. Be especially careful when braking, accelerating or shifting gears. On a slippery surface, an abrupt change in vehicle speed can cause the drive

wheels to lose traction and the vehicle to go out of control.

- Optimum vehicle performance and economy is obtained by smoothly depressing and releasing the accelerator pedal.

WARNING

- When driving uphill or downhill, always shift to D (Drive) for driving forward or shift to R (Reverse) for driving backwards, and check the gear position indicated on the cluster before driving. Driving in the opposite direction of the selected gear can lead to a dangerous situation by shutting off the engine and affecting the braking performance.
- Always buckle-up! In a collision, an unbelted occupant is significantly more likely to be seriously injured or killed than a properly belted occupant.
- Avoid high speeds when cornering or turning.
- Do not make quick steering wheel movements, such as sharp lane changes or fast, sharp turns.
- The risk of a rollover is greatly increased if you lose control of your vehicle at highway speeds.
- In the event your vehicle leaves the roadway, do not steer sharply. Instead, slow down

before pulling back into the travel lanes.

- Never exceed posted speed limits.

⚠ WARNING

If your vehicle becomes stuck in snow, mud, sand, etc., then you may attempt to rock the vehicle free by moving it forward and backward. Do not attempt this procedure if people or objects are anywhere near the vehicle. During the rocking operation the vehicle may suddenly move forward or backward as it becomes unstuck, causing injury or damage to nearby people or objects.

Moving up a steep grade from a standing start

To move up a steep grade from a standing start:

1. Depress the brake pedal, shift the shift lever to D (Drive).
2. Select the appropriate gear depending on load weight and steepness of the grade, and release the parking brake.
3. Depress the accelerator gradually while releasing the service brakes.

When accelerating from a stop on a steep hill, the vehicle may have a tendency to roll backwards.

Brake system

Your vehicle has power-assisted brakes, parking brake, and various braking systems for safe driving.

Power brakes

Your vehicle has power-assisted brakes that adjust automatically through normal usage.

In the event that the power-assisted brakes lose power because of a stalled engine or some other reason, you can still stop your vehicle by applying greater force to the brake pedal than you normally would. The stopping distance, however, will be longer.

When the engine is not running, the reserve brake power is partially depleted each time the brake pedal is applied. Do not pump the brake pedal when the power assist has been interrupted.

Pump the brake pedal only when necessary to maintain steering control on slippery surfaces.

⚠ CAUTION

Brake Pedal

Do not drive with your foot resting on the brake pedal. This will create abnormally high brake temperatures which can cause excessive brake lining and pad wear.

⚠ WARNING**Steep hill braking**

Avoid continuous application of the brakes when descending a long or steep hill by shifting to a lower gear. Continuous brake application will cause the brakes to overheat and could result in a temporary loss of braking performance.

Wet brakes may impair the vehicle's ability to safely slow down; the vehicle may also pull to one side when the brakes are applied. Applying the brakes lightly will indicate whether they have been affected in this way. Always test your brakes in this fashion after driving through deep water. To dry the brakes, apply them lightly while maintaining a safe forward speed until brake performance returns to normal.

In the event of brake failure

If service brakes fail to operate while the vehicle is in motion, you can make an emergency stop with the parking brake. The stopping distance, however, will be much greater than normal.

⚠ WARNING**Parking brake**

Avoid applying the parking brake to stop the vehicle while it is moving except in an emergency situation. Applying the parking brake while the vehicle is moving at normal speeds can cause a sudden loss of control of the vehicle. If you must use the parking brake to stop the vehicle, use great caution in applying the brake.

Brake Over Accelerator

In the event the accelerator pedal becomes stuck or entrapped, apply steady and firm pressure to the brake pedal to slow the vehicle and reduce engine power.

If you experience this condition, take the following steps:

1. Apply the brakes and bring your vehicle to a safe stop.
2. Move the transmission to P (Park), switch the engine off and apply the parking brake.
3. Inspect the accelerator pedal for any interference.

If none are found and the condition persists, have your vehicle towed to an authorized Kia dealer and inspected.

Disc brakes wear indicator

When your brake pads are worn and new pads are required, you will hear a high-pitched warning sound from your front brakes or rear brakes. You may hear this sound come and go or it may occur whenever you press the brake pedal.

Please remember that some driving conditions or climates may cause a brake squeal when you first apply (or lightly apply) the brakes. This is normal and does not indicate a problem with your brakes.

Always replace the front or rear brake pads as pairs.

⚠ CAUTION**Replace brake pads**

Do not continue to drive with worn brake pads. Continuing to drive with worn brake pads can damage the braking system and result in costly brake repairs.

⚠ WARNING**Brake wear**

Do not ignore high pitched wear sounds from your brakes. If you ignore this audible warning, you will eventually lose braking performance, which could lead to a serious accident.

*** NOTICE**

Brake dust may accumulate on the wheels, even under normal driving conditions. Some dust is inevitable as the brakes wear and contribute to brake noise.

Parking Brake (Hand type) (if equipped)

After parking the vehicle, apply the parking brake to prevent the vehicle from being moved by the external force.

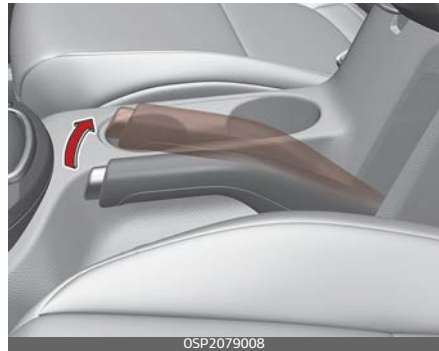
Applying the parking brake

OSP2079008

To engage the parking brake:

1. Apply the foot brake and then pull up the parking brake lever as far as possible.

In addition it is recommended that when parking the vehicle on an incline, the shift lever should be in P (park).

⚠ CAUTION

- Driving with the parking brake applied will cause excessive brake pad and brake rotor wear.
- Do not operate the parking brake while the vehicle is moving except in an emergency situation. It could damage the vehicle system and endanger driving safety.

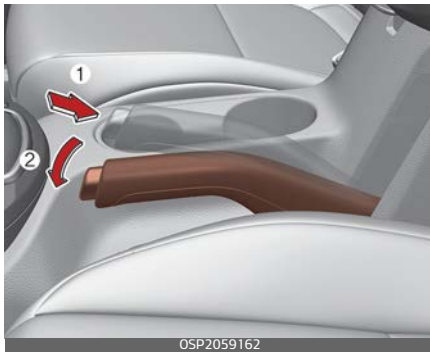
Releasing the parking brake

To release the parking brake:

1. Apply the foot brake and pull up the parking brake lever slightly.
2. Depress the release button (1) and lower the parking brake lever (2) while holding the button.

If the parking brake does not release or does not release all the way, have the system checked by an authorized Kia dealer.

- Be cautious when parking on a hill. Firmly engage the parking brake and place the shift lever in P (park). If your vehicle is facing downhill, turn the front wheels into the curb to help keep the vehicle from rolling. If your vehicle is facing uphill, turn the front wheels away from the curb to help keep the vehicle from rolling. If there is no curb or if it is required by other conditions to keep the vehicle from rolling, block the wheels.
- Under some conditions your parking brake can freeze in the engaged position. This is most likely to happen when there is an accumulation of snow or ice around or near the rear brakes or if the brakes are wet. If there is a risk that the parking brake may freeze, apply it only temporarily while you put the shift lever in P (park) and block the rear wheels so the vehicle cannot roll. Then release the parking brake.
- Do not hold the vehicle on the upgrade with the accelerator pedal. This can cause the transmission to overheat. Always use the brake pedal or parking brake.

⚠ WARNING

- Never allow a passenger to touch the parking brake. If the parking brake is released unintentionally, serious injury may occur.
- All vehicles should always have the parking brake fully engaged when parking to avoid inadvertent movement of the vehicle which can injure occupants or pedestrians.

(!) (P) BRAKE

Check the brake warning light by turning the ignition switch ON (do not start the engine). This light will be illuminated when the parking brake is applied with the ignition switch in the START or ON position.

Before driving, be sure the parking brake is fully released and the brake warning light is off.

If the brake warning light remains on after the parking brake is released while engine is running, there may be a malfunction in the brake system. Immediate attention is necessary.

If at all possible, cease driving the vehicle immediately. If that is not possible, use extreme caution while operating the vehicle and only continue to drive the vehicle until you can reach a safe location or repair shop.

Electronic Parking Brake (EPB) (if equipped)

After parking the vehicle, apply the Electronic Parking Brake (EPB) to prevent the vehicle from being moved by the external force.

Applying the EPB



1. Press the brake pedal.
2. Pull up the EPB switch.
3. Make sure the warning light comes on.

Also, the EPB is applied automatically if the Auto Hold button is on when the vehicle is turned off. In addition, if you pull up the EPB switch after the vehicle is turned off, the EPB will be applied.

⚠ WARNING

Risk of accident and injury due to children left unattended in the vehicle.

If you leave children unaccompanied in the vehicle, they may be able to set the vehicle in motion, for example by:

- Releasing the parking brake.
- Shifting the transmission out of P (Park) position.
- Starting the engine. In addition, they may operate vehicle equipment.

Never leave children and animals unattended in the vehicle.

When leaving the vehicle, always take the smart key with you and lock the vehicle.

*** NOTICE**

On a steep incline or when pulling a trailer, if the vehicle does not remain at a standstill, do as follows:

1. Apply the EPB.
2. Pull up the EPB switch for more than 3 seconds.

Do not operate the EPB while the vehicle is moving except in an emergency situation.

*** NOTICE**

A click or electric brake motor whine sound may be heard while operating or releasing the EPB.

These conditions are normal and indicate that the EPB is functioning properly.

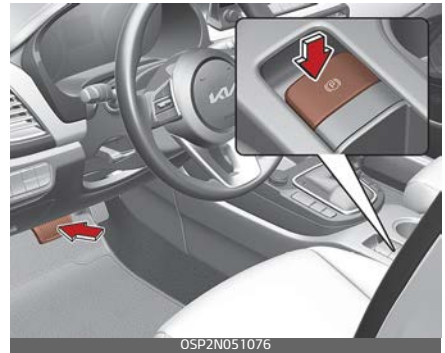
Releasing the EPB with EPB switch

Releasing the parking brake with EPB switch,

1. Have the ENGINE START/STOP button in the ON position.
2. Press the brake pedal.
3. The shift lever must be in P (Park).
4. Press the EPB switch.
5. Make sure the brake warning light goes off.

Automatic release of EPB

The EPB is released automatically under following conditions.

- Shift lever in P (Park)

With the engine running engage the brake pedal and shift out of P (Park) to R (Reverse) or D (Drive).
- Shift lever in N (Neutral)

With the engine running engage the brake pedal and shift out of N (Neutral) to R (Reverse) or D (Drive).
- Automatic transmission
 1. Start the engine.
 2. Fasten the driver's seat belt.
 3. Close the driver's door, hood and liftgate.
 4. Press the accelerator pedal while the shift lever is in R (Rear), D (Drive) or Sports mode.

Make sure the brake warning light goes off.

*** NOTICE**

- For your safety, you can engage the EPB even though the ENGINE START/STOP button is in the OFF position, but you cannot release it.
- For your safety, press the brake pedal and release the parking brake manually with the EPB switch when you drive downhill or when backing up the vehicle.

Do not follow the above procedure when driving on a flat level ground. The vehicle may suddenly move forward.

*** NOTICE**

If the parking brake warning light is still on even though the EPB has been released, have the system checked by an authorized Kia dealer.

⚠ CAUTION

Do not drive your vehicle with the EPB applied. It may cause excessive brake pad and brake rotor wear.

Automatic application of EPB

The EPB is applied automatically under following conditions.

- The EPB is overheated
- Requested by other systems

*** NOTICE**

For Electronic Parking Brake (EPB) equipped vehicles with AUTO HOLD function used while driving, if the ENGINE START/STOP button has been turned OFF, the EPB will be engaged automatically. Therefore, AUTO HOLD function should be turned off before the ENGINE START/STOP button is turned off.

EPB warning

The EPB will display a warning message with sound under certain conditions.

- If you try to drive off while engaging the accelerator pedal with the EPB applied, but the EPB doesn't release automatically, a warning will sound and a message will appear.
- If the driver's seat belt is not fastened and the vehicle hood, driver's door or liftgate is opened, a warning will sound and a message will appear.



- If there is a problem with the vehicle, a warning may sound and a message may appear.

If the above situation occurs, press the brake pedal and release EPB by pressing the EPB switch.

⚠ WARNING**Parking Brake Use**

- Never allow a passenger to touch the parking brake. If the parking brake is released unintentionally, serious injury may occur.
 - All vehicles should always have the parking brake fully engaged when parked to avoid inadvertent movement of the vehicles which can injure occupants or pedestrians.
-
- A click or electric brake motor whine sound may be heard while operating or releasing the EPB. These conditions are normal and indicate that the EPB is functioning properly.
 - When leaving your keys with a parking lot attendant or valet, make sure to inform him/her how to operate the EPB.
 - The EPB may malfunction if you drive with the EPB applied.
 - When you automatically release EPB by pressing the accelerator pedal, press it slowly.

When the conversion from Auto Hold to EPB is not working properly a warning will sound and a message will appear.

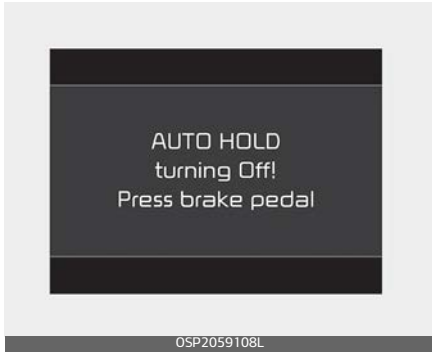

*** NOTICE**

Engage the brake pedal when the above message appears for the Auto Hold and EPB may not activate.

If the EPB is applied while Auto Hold is activated because of an Electronic Stability Control (ESC) signal, a warning will sound and a message will appear.



EPB malfunction indicator

This warning light illuminates if the ENGINE START/STOP button is changed to the ON position and goes off in approximately 3 seconds if the system is operating normally.



If the EPB malfunction indicator remains on, comes on while driving, or does not come on when the ENGINE START/STOP button is changed to the ON position, this indicates that the EPB may have malfunctioned.

If this occurs, have your vehicle checked by an authorized Kia dealer as soon as possible.

The EPB malfunction indicator may illuminate when the ESC indicator comes on to indicate that the ESC is not working properly, but it does not indicate a malfunction of the EPB.

The EPB warning light may illuminate if the EPB switch operates abnormally. Shut the engine off and turn it on again after a few minutes. The warning light will go off and the EPB switch will operate normally. However, if the EPB warning light is still on, have the system checked by an authorized Kia dealer.

If the parking brake warning light does not illuminate or blinks even though the EPB switch was pulled up, the EPB is not applied.

If the parking brake warning light blinks when the EPB warning light is on, press the EPB switch, then pull it up. Once more press it back to its original position and pull it back up. If the EPB warning does not go off, have the system checked by an authorized Kia dealer.

Emergency braking with the EPB switch

If there is a problem with the brake pedal while driving, emergency braking is possible by pulling up and holding the EPB switch.

Braking is possible only while you are holding the EPB switch.

⚠ WARNING

Do not operate the Electronic Parking Brake (EPB) while the vehicle is moving except in an emergency situation. Applying the EPB while the vehicle is moving at normal speeds can cause a sudden loss of control of the vehicle. If you must use the EPB to stop the vehicle, use great caution in applying the brake.

*** NOTICE**

During emergency braking by the EPB, the parking brake warning light will illuminate to indicate that the system is operating.

If you notice a continuous noise or burning smell when the EPB is used for emergency braking, have your vehicle checked by an authorized Kia dealer.

When the EPB is not released

If the EPB does not release normally, take your vehicle to an authorized Kia dealer by loading the vehicle on a flatbed tow truck and have the system checked.

Anti-lock Brake System (ABS)

The Anti-lock Brake System (ABS) prevents the wheels from locking. So the vehicle remains stable and can still be steered.

ABS (or ESC) will not prevent accidents due to improper or dangerous driving maneuvers. Even though vehicle control is improved during emergency braking, always maintain a safe distance between you and objects ahead. Vehicle speeds should always be reduced during extreme road conditions. The vehicle should be driven at reduced speeds in the following circumstances:

- When driving on rough, gravel or snow-covered roads
- When driving with tire chains installed
- When driving on roads where the road surface is pitted or has different surface heights.

Driving in these conditions increases the stopping distance for your vehicle.

The ABS continuously senses the speed of the wheels. If the wheels are going to lock, the ABS repeatedly modulates the hydraulic brake pressure to the wheels.

When you apply your brakes under conditions which may lock the wheels, you may hear a "tik-tik" sound from the brakes, or feel a corresponding sensation in the

brake pedal. This is normal and it means your ABS is active.

In order to obtain the maximum benefit from your ABS in an emergency situation, do not attempt to modulate your brake pressure and do not try to pump your brakes. Press your brake pedal as hard as possible to allow the ABS to control the force being delivered to the brakes.

* NOTICE

A click sound may be heard in the vehicle compartment when the vehicle begins to move after the vehicle is started. These conditions are normal and indicate that the Anti-lock Brake System is functioning properly.

Even with the Anti-lock Brake System, your vehicle still requires sufficient stopping distance. Always maintain a safe distance from the vehicle in front of you.

Always slow down when cornering. The Anti-lock Brake System cannot prevent accidents resulting from excessive speeds.

On loose or uneven road surfaces, operation of the Anti-lock Brake System may result in a longer stopping distance than for vehicles equipped with a conventional brake system.

The ABS warning light will stay on for approximately 3 seconds after the ENGINE START/STOP button is ON.



During that time, the ABS will go through self-diagnosis and the light will go off if everything is normal. If the light stays on, you may have a problem with your ABS. Contact an authorized Kia dealer as soon as possible.

When you drive on a road having poor traction, such as an icy road, and have operated your brakes continuously, the ABS will be active continuously and the ABS warning light may illuminate. Pull your vehicle over to a safe place and stop the vehicle.

Restart the vehicle. If the ABS warning light goes off, then your ABS is normal. Otherwise, you may have a problem with the ABS. Contact an authorized Kia dealer as soon as possible.

* NOTICE

When you jump start your vehicle because of a drained battery, the vehicle may not run as smoothly and the ABS warning light may turn on at the same time. This happens

because of low battery voltage. It does not mean your ABS has malfunctioned.

- Do not pump your brakes!
- Have the battery recharged before driving the vehicle.

AUTO HOLD (if equipped)

The Auto Hold is designed to maintain the vehicle in a standstill even though the brake pedal is not pressed after the driver brings the vehicle to a complete stop by pressing the brake pedal.

Applying Auto Hold function

1. Press the brake pedal and start the vehicle.
2. Press the Auto Hold button. The white AUTO HOLD indicator will come on indicating the system is in standby.

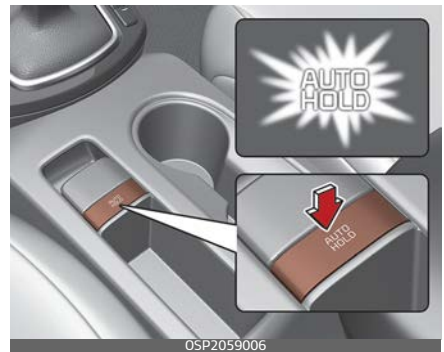

Before the Auto Hold will engage, the driver's door and engine hood must be closed.

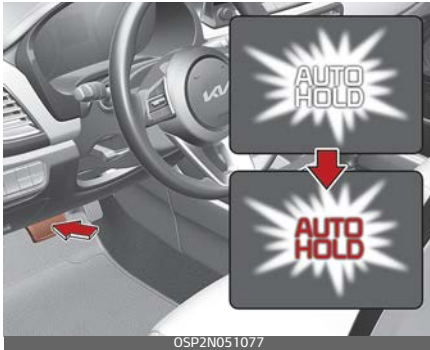

When coming to a complete stop by pressing the brake pedal, the AUTO HOLD indicator changes from white to green indicating the AUTO HOLD is engaged. The vehicle will remain at a standstill even if you release the brake pedal.

If EPB is applied, Auto Hold will be released.

If you press the accelerator pedal with the shift lever in D (Drive) or Manual mode, the Auto Hold will be released automatically and the vehicle will start to move. The indicator changes from green to white indicating the Auto Hold is in standby and the EPB is released.

When driving off from Auto Hold by pressing the accelerator pedal, always check the surrounding area near your vehicle.

Slowly press the accelerator pedal for a smooth launch.

Canceling Auto Hold function

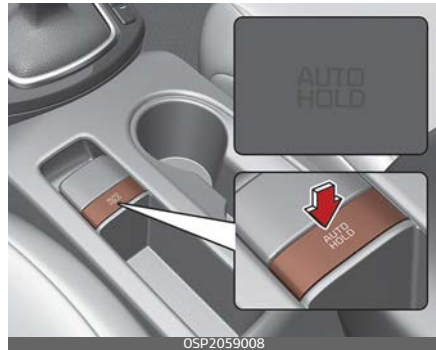

- To cancel the Auto Hold operation, press the Auto Hold switch. The AUTO HOLD indicator will go out.
- To cancel the Auto Hold operation when the vehicle is at a standstill, press the Auto Hold switch while pressing the brake pedal.

* NOTICE

- The following are conditions when the Auto Hold will not engage (Auto Hold light will not turn green and the Auto Hold system remains in stand by):
 - The driver's door is opened
 - The engine hood is opened
 - The shift lever is in P (Park) or R (Reverse)
 - The EPB is applied
- For your safety, the Auto Hold automatically switches to EPB under any of the following conditions (Auto Hold light remains white and the EPB automatically applies):
 - The driver's door is opened.

- The engine hood is opened.
- The vehicle is in a standstill for more than 10 minutes.
- The vehicle is standing on a steep slope.
- The vehicle moved for a few seconds.

In these cases, the brake warning light comes on, the AUTO HOLD indicator changes from green to white, and a warning sounds and a message will appear to inform you that EPB has been automatically engaged. Before driving off again, press foot brake pedal, check the surrounding area near your vehicle and release parking brake manually with the EPB switch.

- If the AUTO HOLD indicator lights up yellow, the Auto Hold is not working properly. Take your vehicle to an authorized Kia dealer and have the system checked.

▲ WARNING

To reduce the risk of an accident, do not activate Auto Hold while driving downhill, backing up or parking your vehicle.

If there is a malfunction with the driver's door or engine hood open detection system, the Auto Hold may not work properly.

Take your vehicle to an authorized Kia dealer and have the system checked.

*** NOTICE**

A click or electric brake motor whine sound may be heard while operating or releasing the EPB, but these conditions are normal and indicate that the EPB is functioning properly.

Warning messages

The Auto Hold function will display a warning message with sound under certain conditions.

When the EPB is applied from Auto Hold, a warning will sound and a message will appear.

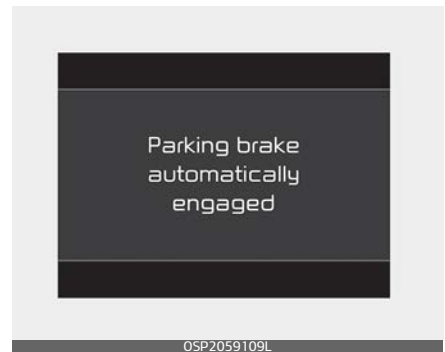

When the conversion from Auto Hold to EPB is not working properly a warning will sound and a message will appear.

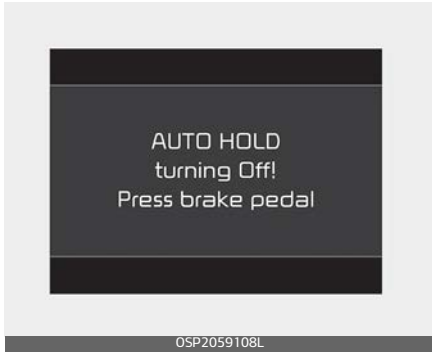

*** NOTICE**

When this message is displayed, the Auto Hold and EPB may not operate. For your safety, press the brake pedal.

If you do not apply the brake pedal when you release the Auto Hold by pressing the [AUTO HOLD] switch, a warning will sound and a message will appear.



When you press the [AUTO HOLD] switch, if the driver's door and engine hood are not closed, a warn-

ing will sound and a message will appear on the LCD display.

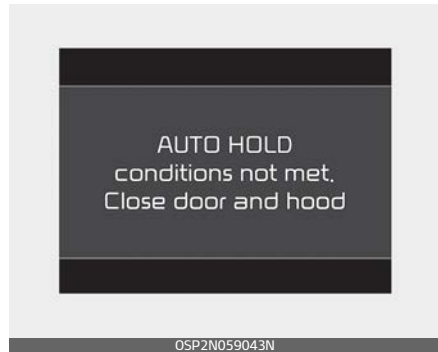

At this moment, press the [AUTO HOLD] button after closing the driver's door and engine hood.

Electronic Stability Control (ESC) system

The Electronic Stability Control (ESC) is designed to stabilize the vehicle during cornering maneuvers.



ESC applies the brakes on individual wheels and intervenes with the vehicle management system to stabilize the vehicle.

ESC will not prevent accidents. Excessive speed in turns, abrupt maneuvers and hydroplaning on wet surfaces can still result in serious accidents.

Only a safe and attentive driver can prevent accidents by avoiding maneuvers that cause the vehicle to lose traction. Even with ESC installed, always follow all the normal precautions for driving - including driving at safe speeds for the conditions.

⚠ WARNING

For maximum protection, always wear your seat belt. No system, no matter how advanced, can compensate for all driver error and/or driving conditions. Always drive responsibly.

The ESC system is an electronic system designed to help the driver maintain vehicle control under adverse conditions. It is not a substitute for safe driving practices. Factors including speed, road conditions and driver steering input can all affect whether ESC will be effective in preventing a loss of control. It is still your responsibility to drive and corner at reasonable speeds and to leave a sufficient margin of safety.

When you apply your brakes under conditions which may lock the wheels, you may hear a "tik-tik" sound from the brakes, or feel a corresponding sensation in the brake pedal. This is normal and it means your ESC is active.

*** NOTICE**

A click sound may be heard in the vehicle compartment when the vehicle begins to move after the vehicle is started. These conditions are normal and indicate that the Electronic Stability Control system is functioning properly.

ESC operation

ESC ON condition

- When the ENGINE START/STOP button is turned ON, ESC and ESC OFF indicator lights illuminate for approximately 3 seconds, then ESC is turned on.
- Press the ESC OFF button for at least half a second after turning the vehicle ON to turn ESC off. (ESC OFF indicator will illuminate). To turn the ESC on, press the ESC OFF button (ESC OFF indicator light will go off).
- When starting the vehicle, you may hear a slight ticking sound. This is the ESC performing an

automatic system self-check and does not indicate a problem.

When operating

 When the ESC is in operation, the ESC indicator light blinks.

When the Electronic Stability Control is operating properly, you can feel a slight pulsation in the vehicle. This is only the effect of brake control and indicates nothing unusual.

When moving out of the mud or driving on a slippery road, pressing the accelerator pedal may not cause the vehicle rpm (revolutions per minute) to increase.



ESC operation off

 This car has 2 kinds of ESC off states.

If the vehicle stops when ESC is off, ESC remains off. Upon restarting the vehicle, the ESC will automatically turn on again.





ESC off state 1

To turn off the traction control function and only operate the brake control function of the ESC, press the ESC OFF button (ESC OFF ) for less than 3 seconds and the ESC OFF indicator light (ESC OFF ) will illuminate.



ESC off state 2

To turn off the traction control function and the brake control function of the ESC, press the ESC OFF button (ESC OFF ) for more than 3 seconds. ESC OFF indicator light (ESC OFF ) will illuminate and ESC OFF warning chime will sound. At this state, the car stability control function does not operate any more.

Indicator light

ESC indicator light



ESC OFF indicator light



When ENGINE START/STOP button is turned to ON, the indicator light illuminates, then goes off if the ESC system is operating normally.

The ESC indicator light blinks whenever ESC is operating or illuminates when ESC fails to operate.

The ESC OFF indicator light comes on when the ESC is turned off with the button.

⚠ WARNING**Electronic Stability Control**

Drive carefully even though your vehicle has Electronic Stability Control. It can only assist you in maintaining control under certain circumstances.

ESC OFF usage**When driving**

- ESC should be turned on for daily driving whenever possible.
- To turn ESC off while driving, press the ESC OFF button while driving on a flat road surface.

⚠ WARNING**Operating ESC**

Never press the ESC OFF button while ESC is operating (ESC indicator light blinks).

If ESC is turned off while ESC is operating, the vehicle may slip out of control.

*** NOTICE**

- When operating the vehicle on a dynamometer, ensure that the ESC is turned off (ESC OFF light illuminated). If the ESC is left on, it may prevent the vehicle speed from increasing, and result in false diagnosis.
- Turning the ESC off does not affect ABS or brake system operation.

Vehicle Stability Management (VSM) system

The Vehicle Stability Management (VSM) provides further enhancements to vehicle stability and steering responses under the following condition:

- when driving on a slippery road or
- when a change in the coefficient of friction between left and right wheels is detected.

⚠ WARNING**Tire/Wheel size**

When replacing tires and wheels, make sure they are the same size as the original tires and wheels installed. Driving with varying tire or wheel sizes may diminish any supplemental safety benefits of the VSM system.

VSM operation

When the VSM is operating properly, you can feel a slight pulsation in the vehicle and/or abnormal steering responses (Electronic Power Steering (EPS)). This is only the effect of brake and EPS control and indicates nothing unusual.

The VSM does not operate when:

- Driving on a sloping road such as a gradient or incline
- Driving in reverse
- ESC OFF indicator light () remains on the instrument cluster
- EPS indicator light remains on the instrument cluster

VSM operation off

If you press the ESC OFF button to turn off the ESC, the VSM will also cancel and the ESC OFF indicator light () illuminates.

To turn on the VSM, press the button again. The ESC OFF indicator light goes out.

⚠ WARNING**Vehicle Stability Management**

Drive carefully even though your vehicle has Vehicle Stability Management. It can only assist you in maintaining control of the vehicle under certain circumstances.

Malfunction indicator

The VSM can be deactivated even if you don't cancel the VSM operation by pressing the ESC OFF button. It indicates that a malfunction has been detected somewhere in the Electric Power Steering system or VSM system. If the ESC indicator light () or EPS warning light remains on, take your vehicle to an authorized Kia dealer and have the system checked.

The VSM is not a substitute for safe driving practices but a supplementary function only. It is the responsibility of the driver to always check the speed and the distance to the vehicle ahead. Always hold the steering wheel firmly while driving.

Your vehicle is designed to activate according to the driver's intention, even with installed VSM. Always follow all the normal precautions for driving at safe speeds for the conditions – including driving in clement weather and on a slippery road.

WARNING

For maximum protection, always wear your seat belt. No system, no matter how advanced, can compensate for all driver error and/or driving conditions. Always drive responsibly.

Hill-start Assist Control (HAC)

A vehicle has the tendency to roll back on a steep hill when it starts to go after stopping. The Hill-start Assist Control (HAC) prevents the vehicle from rolling back by applying the brakes automatically for about 2 seconds.

The brakes are released when the accelerator pedal is engaged or after about 2 seconds.

The HAC is activated only for about 2 seconds, so when the vehicle is starting off always engaged the accelerator pedal.

WARNING

Maintaining Brake Pressure on Incline

HAC does not replace the need to apply brakes while stopped on an incline. While stopped, make sure you maintain brake pressure sufficient to prevent your vehicle from rolling backward and causing an accident. Don't release the brake pedal until you are ready to accelerate forward.

Downhill Brake Control (DBC)



The Downhill Brake Control (DBC) feature assists the driver to descend down a steep hill without having to depress the brake pedal.

The system automatically applies the brakes to maintain the vehicle speed 2.5 mph (4 km/h) ~ 25 mph (40 km/h) and allows the driver to concentrate on steering the vehicle down hill.

Always turn off the DBC on normal roads. The DBC might activate inadvertently from the stand by mode when driving through speed bumps or making sharp curves.





* NOTICE

The DBC defaults to the OFF position whenever the ignition switch is placed in the ON position.

Noise or vibration may occur from the brakes when the DBC is activated.

The rear stop light comes on when DBC is activated.

DBC operation

Mode	Indicator light	Description
Standby	 illuminated	Press the DBC button when vehicle speed is under 38 mph (60 km/h). The DBC system will turn ON and enter the standby mode. The system does not turn ON if vehicle speed is over 38 mph (60 km/h).
Activated	 blinks	In the standby mode, It enters the operating mode when the following conditions are met. <ul style="list-style-type: none"> • The road surface should be more than a certain angle of inclination • The accelerator pedal must not be depressed. • The vehicle speed should be within 2.5 mph (4 km/h) ~ 25 mph (40 km/h) <ul style="list-style-type: none"> - 1.5 mph (2.5 km/h) ~ 5 mph (8 km/h) in case of backward movement Within operating vehicle speed [2.5 mph (4 km/h) ~ 25 mph (40 km/h)], the driver can lower or raise the vehicle speed by stepping on the brake pedal or accelerator pedal.
Temporarily deactivated	 illuminated	In the activated mode, the DBC will temporarily deactivate under the following conditions: <ul style="list-style-type: none"> • The hill is not steep enough. • The accelerator pedal is depressed. • When the vehicle speed is in the range of 25 mph (40 km/h) ~ 38 mph (60 km/h) If the above conditions are not met, the DBC will automatically activate again.
OFF	 not illuminated	The DBC will turn OFF under the following conditions: <ul style="list-style-type: none"> • The DBC button is pressed again. • When the accelerator pedal is depressed and the vehicle speed exceeds 38 mph (60 km/h)

⚠ WARNING

If the DBC red indicator light illuminates, the system may have overheated or have malfunctioned. When the warning light illuminates even though the DBC system has cooled off, have your vehicle checked by an authorized Kia dealer as soon as possible.

*** NOTICE**

- The DBC may not deactivate on steep inclines even though the brake or accelerator pedal is depressed.
- The DBC does not operate when:
 - The shift lever is in P (Park).
 - The ESC is activated.

Good braking practices

Good braking practices help keep occupants safe and extend brake life.

- Check to be sure the parking brake is not engaged and the parking brake indicator light is out before driving away.
- Driving through water may get the brakes wet. They can also get wet when the vehicle is washed. Wet brakes can be dangerous! Your vehicle will not stop as quickly if the brakes are wet. Wet brakes may cause the vehicle to pull to one side.

To dry the brakes, apply the brakes lightly until the braking action returns to normal, taking care to keep the vehicle under control at all times. If the braking action does not return to normal, stop as soon as it is safe to do so and call an authorized Kia dealer for assistance.

- Don't coast down hills with the vehicle out of gear. This is extremely hazardous. Keep the vehicle in gear at all times, use the brakes to slow down, then shift to a lower gear so that vehicle braking will help you maintain a safe speed.
- Don't "ride" the brake pedal. Resting your foot on the brake pedal while driving can be dangerous because the brakes might overheat and lose their effectiveness. It also increases the wear of the brake components.
- If a tire goes flat while you are driving, apply the brakes gently and keep the vehicle pointed straight ahead while you slow down. When you are moving slowly enough for it to be safe to do so, pull off the road and stop in a safe place.
- Be cautious when parking on a hill. Firmly engage the parking brake and place the shifter dial in P. If your vehicle is facing downhill, turn the front wheels into the

curb to help keep the vehicle from rolling.

If your vehicle is facing uphill, turn the front wheels away from the curb to help keep the vehicle from rolling. If there is no curb or if it is required by other conditions to keep the vehicle from rolling, block the wheels.

- Under some conditions your parking brake can freeze in the engaged position. This is most likely to happen when there is an accumulation of snow or ice around or near the rear brakes or if the brakes are wet. If there is a risk that the parking brake may freeze, apply it only temporarily while you put the shifter dial in P and block the rear wheels so the vehicle cannot roll. Then release the parking brake.
- Do not hold the vehicle on an incline with the accelerator pedal. This can cause the transmission to overheat. Always use the brake pedal or parking brake.

Idle Stop and Go (ISG) system

The Idle Stop and Go (ISG) system reduces fuel consumption by automatically shutting down the engine when the vehicle is at a standstill. (For example: red light, stop sign and traffic jam)

The engine starts automatically as soon as the starting conditions are met.

The ISG is ON whenever the engine is running.

* NOTICE

When the engine automatically starts by the ISG system, some warning lights (ABS, ESC, ESC OFF, EPS or Parking brake warning light) may turn on for a few seconds.

This happens because of low battery voltage. It does not mean the system has malfunctioned.

Auto stop

If you depress the brake pedal and the vehicle comes to a stop with the ISG ON, the engine will stop automatically.

Stop the vehicle completely by pressing the brake pedal when the shift lever is in the D (Drive) or N (Neutral) position.



OSP2N059016

The engine will stop and the green AUTO STOP (A) indicator on the instrument cluster will illuminate.



OSP2N059046N

* NOTICE

If you open the engine hood in auto stop mode, the following will happen:

- The ISG system will deactivate (the light on the ISG OFF button will illuminate).
- A message will appear on the LCD display.

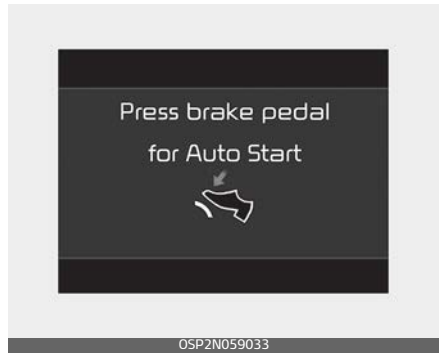

OSP2N059033

- If you move the transmission lever from N to D (Manual mode) or R without depressing the brake pedal after stopping engine automatically, the engine does not restart automatically and a warning chime alarms. When this happens, press the brake pedal for auto start.

Auto start

When the engine stops automatically by ISG, the engine will restart if one of the following driver actions occur.

- Release the brake pedal.
- Move the shift gear to the R (Reverse) position or the Manual mode while depressing the brake pedal.



The engine will start and the green AUTO STOP indicator (A) on the instrument cluster will go out.

The engine will also restart automatically without any driver actions if the following occurs:

- The brake vacuum pressure is low.
- The engine has stopped for about 5 minutes.
- The air conditioning is ON with the fan speed set to the highest position.
- The front defroster is ON.
- The battery is weak.

- The cooling and heating performance of the climate control system is unsatisfactory.
- The vehicle is shifted to P (Park) when Auto Hold is activated.
- The door is opened or the seatbelt is unfastened when Auto Hold is activated.
- The EPB switch is pressed when Auto Hold is activated.

Operating conditions

The ISG will operate under the following condition:

- The driver's seatbelt is fastened.
- The driver's door and hood are closed.
- The brake vacuum pressure is adequate.
- The battery sensor is activated and the battery is sufficiently charged.
- Outside temperature is not too low or too high.
- The vehicle is driven over a constant speed and stops.
- The climate control system satisfies the conditions.
- The vehicle is sufficiently warmed up.
- The incline is gradual.
- The steering wheel is turned less than 180 degrees and then the vehicle stops.

*** NOTICE**

- If the ISG system does not meet the operation condition, the ISG system is deactivated. The light on the ISG OFF button will illuminate and a message "Auto Stop conditions not met" will appear on the LCD display.
- If the light or warning message comes on continuously, please check the operation condition.

Deactivating the ISG



- If you wish to deactivate the ISG, press the ISG OFF button. The light on the ISG OFF button will illuminate.
- If you press the ISG OFF button again, the ISG will be activated and the light on the ISG OFF button will turn off.

ISG malfunction

The ISG may not operate when:



The ISG may not operate when an ISG related sensor or system error occurs.

The following will happen:

- The yellow AUTO STOP (A) indicator on the instrument cluster will stay on after blinking for 5 seconds.
- The light on the ISG OFF button will illuminate.

When the engine is in Idle Stop mode, it's possible to restart the engine without the driver taking any action. Before leaving the car or doing anything in the engine compartment, stop the engine by the ENGINE START/STOP button to the OFF position.

* NOTICE

If the AGM battery is reconnected or replaced, ISG function will not operate immediately. If you want to use the ISG function, the battery sensor needs to be calibrated for approximately 4 hours with the ignition off. After calibration, turn the engine on and off 2 or 3 times.

Drive mode integrated control system

The drive mode may be selected according to the driver's preference or road condition.



The Drive mode is activated by turning the knob.

The Drive mode is changes whenever the knob is turned.

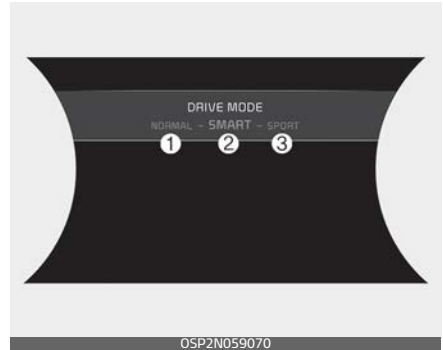

- SMART mode: SMART mode automatically adjusts the driving mode (SMART ↔ SPORT) in accordance with the driver's driving habits.

- **NORMAL mode:** NORMAL mode provides soft driving and comfortable riding.
- **SPORT mode:** SPORT mode provides sporty but firm riding.

The driving mode will be set to COMFORT mode when the engine is restarted. If it is in COMFORT/SPORT mode, COMFORT mode will be set, when the engine is restarted.

SMART mode



SMART SMART mode selects the proper driving mode among COMFORT and OFF by judging the driver's driving habits (i.e., mild or dynamic) from the brake pedal or the steering wheel operation.

- Turning the knob to activate SMART mode. When SMART mode is activated, the indicator illuminates on the instrument cluster (blue color).
- The vehicle starts in SMART mode, when the engine was turned OFF in SMART mode.
- SMART mode automatically controls the vehicle driving, such as gear shifting patterns, engine torque, in accordance with the driver's driving habits.

* NOTICE

- When you mildly drive the vehicle in SMART mode, the driving mode changes to COMFORT mode to improve fuel efficiency. However, the actual fuel efficiency may differ in accordance with your driving situations (i.e., upward/downward slope, vehicle deceleration/acceleration).
- When you dynamically drive the vehicle in SMART mode by abruptly decelerating or sharply curving, the driving mode changes

to SPORT mode. However, it may adversely affect fuel economy.

Various driving situations, which you may encounter in SMART mode

- The driving mode automatically changes to SMART COMFORT mode after a certain period of time, when you gently press the accelerator pedal (Your driving is categorized to be economical.).
- The driving mode automatically changes to SMART SPORT, when you abruptly accelerate the vehicle or repetitively operate the steering wheel (Your driving is categorized to be aggressive.). In this mode, your vehicle drives in a lower gear for abrupt accelerating/decelerating and increases the engine brake performance.
- You may still sense the engine brake performance, even when you release the accelerator pedal in SMART SPORT mode. It is because your vehicle remains to be in a lower gear over a certain period of time for next acceleration. Thus, it is a normal driving situation, not indicating any malfunction.
- The driving mode automatically changes to SMART SPORT mode only in harsh driving situations. In most of the normal driving situations, the driving mode sets to be in SMART COMFORT mode.

Limitation of SMART mode

The SMART mode may be limited in following situations. (The OFF indicator illuminates in those situations.)

- The driver manually moves the shift lever: It deactivates SMART mode. The vehicle moves, as the driver manually moves the shift lever.
- Cruise Control is activated: Cruise Control may deactivate the SMART mode. When a higher system is set by Cruise Control, it starts to control vehicle speed and deactivates SMART mode. (SMART mode is not deactivated just by activating Cruise Control.)
- The transmission oil temperature is either extremely low or extremely high: The SMART mode can be active in most of the normal driving situations. However, an extremely high/ low transmission oil temperature may temporarily deactivate the SMART mode, because the transmission condition is out of normal operation condition.

SPORT mode

SPORT SPORT mode manages the driving dynamics by automatically adjusting the steering effort, and the engine and transmission control logic for enhanced driver performance.

- When SPORT mode is selected by turning the knob, the SPORT indicator (red color) will illuminate.
- Whenever the engine is restarted, the Drive Mode will revert back to NORMAL mode. If SPORT mode is desired, re-select SPORT mode from the knob.
- When SPORT mode is activated:
 - The engine rpm will tend to remain raised over a certain length of time even after releasing the accelerator.
 - Upshifts are delayed when accelerating.

* NOTICE

In SPORT mode, the fuel efficiency may decrease.

Forward Collision-Avoidance Assist (FCA) (Front view camera only) (if equipped)

Forward Collision-Avoidance Assist is designed to detect and monitor the vehicle ahead or a pedestrian in the roadway through front view camera recognition to warn the driver that a collision is imminent, and if necessary, apply emergency braking.

⚠ WARNING

Take the following precautions when using Forward Collision-Avoidance Assist:

- This function is only a supplemental function and it is not intended to, nor does it replace the need for extreme care and attention of the driver. The sensing range and objects detectable by the sensors are limited. Pay attention to the road conditions at all times.
 - NEVER drive too fast in accordance with the road conditions or while cornering.
 - Always drive cautiously to prevent unexpected and sudden situations from occurring. Forward Collision-Avoidance Assist does not stop the vehicle completely and does not avoid all collisions due to function limitations.
-

Forward Collision-Avoidance Assist setting and activation

Forward Collision-Avoidance Assist setting



The driver can activate Forward Collision-Avoidance Assist by placing the ignition switch to the ON position and by selecting on the LCD display:

'User Settings → Driver Assistance → Forward Safety'

- If you select "Active Assist", Forward Collision-Avoidance Assist activates. Forward Collision-Avoidance Assist produces warning messages and warning alarms in accordance with the collision risk levels. Braking assist will be applied in accordance with the collision risk.
- If you select 'Warning Only', Forward Collision-Avoidance Assist activates and produces only warning alarms in accordance with the collision risk levels. Brak-

ing assist will not be applied in this setting.

- If you select 'Off', Forward Collision-Avoidance Assist deactivates.



The warning light illuminates on the LCD display, when you cancel Forward Collision-Avoidance Assist. The driver can monitor Forward Collision-Avoidance Assist ON/OFF status on the LCD display. Also, the warning light illuminates when the ESC (Electronic Stability Control) is turned off. If the warning light remains ON when Forward Collision-Avoidance Assist is activated, you should have the function checked by an authorized Kia dealer.

Warning Timing



The driver can select the initial warning activation time on the LCD display. If your vehicle is equipped with an infotainment system, you can learn how to setup on the web-

site via QR code in the infotainment quick reference guide.

Go to the 'User Settings → Driver Assistance → Warning Timing → Normal/Late'.

The options for the initial Forward Collision Warning includes the following:

- Normal: When this option is selected, the initial Forward Collision Warning is activated sensitively. If you feel the warning activates too early, set Forward Collision Warning to 'Late'. Even though, 'Normal' is selected if the front vehicle suddenly stops the initial warning activation time may not seem fast.
- Late: When this option is selected, the initial Forward Collision Warning is activated later than normal. This setting reduces the amount of distance between the vehicle ahead before the initial warning occurs. Select 'Late' when traffic is light and when driving speed is slow.

*** NOTICE**

If you change the warning timing, the warning time of other functions may change. Always be aware before changing the warning timing.

Warning Volume

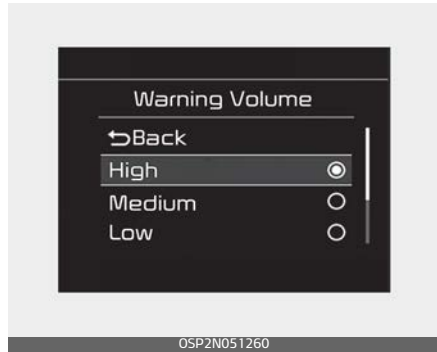

With the ignition switch or the ENGINE START/STOP button in the ON position, go to the 'User Settings' → Driver Assistance → Warning Volume' to change the Warning Volume to 'High', 'Medium', 'Low' for Forward Collision-Avoidance Assist.

If you change the warning volume, the Warning Volume of other Driver Assistance functions may change..

Prerequisite for activation

Forward Collision-Avoidance Assist gets ready to be activated, when 'Active Assist' or 'Warning Only' under Forward Safety is selected in on the LCD display, and when the following prerequisites are satisfied.

- The ESC (Electronic Stability Control) is on.
- Vehicle speed is over 6 mph (10 km/h). (Forward Collision-Avoidance Assist is only activated within a certain speed range.)

- The function detects a vehicle in front, which may collide with your vehicle. (Forward Collision-Avoidance Assist may not be activated or may sound a warning alarm in accordance with the driving situation or vehicle condition.)

⚠ WARNING

- Forward Collision-Avoidance Assist automatically activates upon placing the ignition switch or START/STOP button to the ON position. The driver can deactivate Forward Collision-Avoidance Assist by canceling the function setting on the LCD display. To avoid driver distractions, do not attempt to set or cancel Forward Collision-Avoidance Assist while driving the vehicle.
- Forward Collision-Avoidance Assist automatically deactivates upon canceling the ESC. When the ESC is canceled, Forward Collision-Avoidance Assist cannot be activated on the LCD display. In this situation, Forward Collision-Avoidance Assist warning light will illuminate, but it does not indicate a malfunction of the function.
- Set or cancel Forward Collision-Avoidance Assist with controlling switches on steering wheel after stopping the vehicle in a safe place for your safety.

Forward Collision-Avoidance Assist warning message and brake control

Forward Collision-Avoidance Assist produces warning messages, and warning alarms in accordance with the collision risk levels, such as abrupt stopping of the vehicle in front, insufficient braking distance, pedestrian detection. Also, it controls the brakes in accordance with the collision risk levels.

Collision Warning (1st warning)



This warning message appears on the LCD display with a warning chime. Additionally, some vehicle function intervention occurs by the engine management function to help decelerate the vehicle.

Your vehicle may slow down slightly.

- It will operate if the vehicle speed is greater than 6 mph (10 km/h) and less than or equal to 112 mph (180 km/h) on a forward vehicle. (Depending on the condition of the vehicle ahead and the envi-

ronment surrounding it, the possible maximum operating speed may be reduced.)

- For pedestrian the vehicle speed is greater than or equal to 6 mph (10 km/h) and less than 37 mph (60 km/h). (Depending on the condition of pedestrian and the surrounding environment the possible maximum operating speed may be reduced.)
- If you select 'Warning Only', Forward Collision-Avoidance Assist activates and produces only warning alarms in accordance with the collision risk levels. You should control the brake directly because Forward Collision-Avoidance Assist do not control the brake.

Emergency Braking (2nd warning)



This warning message appears on the LCD display with a warning chime. Additionally, some vehicle system intervention occurs by the

engine management system to help decelerate the vehicle.

The brake control is maximized just before a collision, reducing impact when it strikes a forward vehicle.

- It will operate if the vehicle speed is greater than 6 mph (10 km/h) and less than or equal to 37 mph (60 km/h) on a forward vehicle. (Depending on the condition of the vehicle ahead and the environment surrounding it, the possible maximum operating speed may be reduced.)
- For pedestrian, the vehicle speed is greater than or equal to 6 mph (10 km/h) and less than 37 mph (60 km/h). (Depending on the condition of pedestrian and the surrounding environment the possible maximum operating speed may be reduced.)
- If you select 'Warning Only', Forward Collision-Avoidance Assist activates and produces only warning alarms in accordance with the collision risk levels. You should control the brake directly because Forward Collision-Avoidance Assist do not control the brake.

Brake operation

In an urgent situation, the braking system enters into the ready status for prompt reaction against the driver's depressing the brake pedal.

Driving your vehicle

- Forward Collision-Avoidance Assist provides additional braking power for optimum braking performance, when the driver depresses the brake pedal.
- The braking control is automatically deactivated, when the driver sharply depresses the accelerator pedal, or when the driver abruptly operates the steering wheel.
- Forward Collision-Avoidance Assist brake control is automatically canceled, when risk factors disappear.

⚠ CAUTION

The driver should always use extreme caution when operating the vehicle, even though there is no warning message or warning alarm.

⚠ WARNING

Forward Collision-Avoidance Assist cannot avoid all collisions nor completely stop the vehicle before collision. The driver is responsible to safely drive and control the vehicle.

⚠ WARNING

Forward Collision-Avoidance Assist logic operates within certain parameters, such as the distance from the vehicle ahead, the speed of the vehicle ahead, and the driver's vehi-

Forward Collision-Avoidance Assist (FCA) (Front view camera only)

cle speed. Certain conditions such as inclement weather and road conditions may affect the operation of Forward Collision-Avoidance Assist. Never deliberately drive dangerously to activate the function.

Detecting sensor

Front view camera



The sensor detects vehicle or pedestrian ahead. In order for Forward Collision-Avoidance Assist to operate properly, always make sure the sensor cover or sensor is clean and free of dirt, snow, and debris.

Dirt, snow, or foreign substances may adversely affect the sensing performance of the sensor.

Warning message and warning light

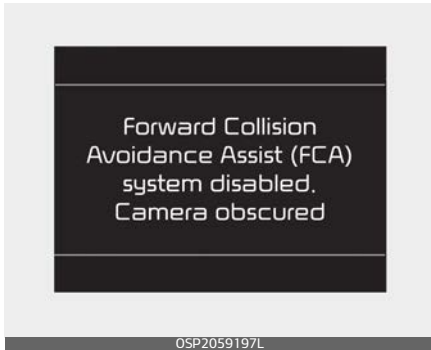

When the front view camera is blocked with dirt, snow, or debris, Forward Collision-Avoidance Assist operation may not be able to detect other vehicles.

If this occurs, a warning message will appear on the LCD display.

The function will operate normally when such dirt, snow or debris is removed.

Forward Collision-Avoidance Assist may not properly operate in an area (e.g. open terrain) where any objects or vehicles are not detected after turning on the engine.

Also, even though a warning message does not appear on the LCD display, Forward Collision-Avoidance Assist may not properly operate.

▲ WARNING

Forward Collision-Avoidance Assist may not activate without any warning messages depending on driving and road conditions.

*** NOTICE**

- Doing so may adversely affect the sensing performance of the sensor.
- Always keep the sensor clean and free of dirt and debris.
- Be careful not to apply unnecessary force on the sensor. If the sensor is forcibly moved out of proper alignment, Forward Collision-Avoidance Assist may not operate correctly. In this case, a warning message may not be displayed. In this case, take your vehicle to an authorized Kia dealer and have the function inspected.
- Use only genuine parts to repair or replace a damaged part.
- Do not tint the window or install stickers and/or accessories around the inside mirror where the front view camera is installed.
- Make sure the front view camera installation point does not get wet.
- Do not impact or arbitrarily remove any front view camera components.

Driving your vehicle

- Do not place reflective objects (white paper or mirror etc.) on the dashboard.
The function may activate unnecessarily due to reflect of the sunlight.
- Excessive audio volume may disturb the sound of the function warning alarm.
- For more precautions related to the front view camera sensor, refer to the "Lane Keeping Assist (LKA) (if equipped)" on page 5-105.

Forward Collision-Avoidance Assist malfunction

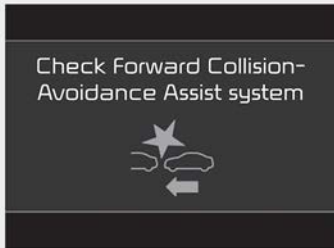

OSK3058067/NR

- When Forward Collision-Avoidance Assist is not working properly, Forward Collision-Avoidance Assist warning light (🌟) will illuminate and the warning message will appear for a few seconds. After the message disappears, the master warning light (⚠️) will illuminate. In this case, you should

Forward Collision-Avoidance Assist (FCA) (Front view camera only)

- have the vehicle inspected by an authorized Kia dealer.
- Forward Collision-Avoidance Assist warning message may appear along with the illumination of the ESC (Electronic Stability Control) warning light. Both Forward Collision-Avoidance Assist warning light and warning message will disappear once the ESC warning light issue is resolved.

⚠️ WARNING

- Forward Collision-Avoidance Assist is only a supplemental function for the driver's convenience. It is the driver's responsibility to control the vehicle operation. Do not solely depend on Forward Collision-Avoidance Assist. Rather, maintain a safe braking distance, and, if necessary, depress the brake pedal to reduce the driving speed or to stop the vehicle.
- In certain instances and under certain driving conditions, Forward Collision-Avoidance Assist may activate unintentionally. This initial warning message appears on the LCD display with a warning chime. Also, due to sensing limitations, in certain situations, the front view camera recognition function may not detect the vehicle ahead. For-

ward Collision-Avoidance Assist may not activate and the warning message may not be displayed.

- Forward Collision-Avoidance Assist may not activate if the driver applies the brake pedal before warning to avoid the risk of a collision.
- Forward Collision-Avoidance Assist does not operate when the vehicle is in reverse.
- Forward Collision-Avoidance Assist is not designed to detect other objects on the road such as animals.
- Forward Collision-Avoidance Assist does not detect vehicles in the opposite lane.
- Forward Collision-Avoidance Assist does not detect cross traffic vehicles that are approaching.
- Forward Collision-Avoidance Assist cannot detect the driver approaching the side view of a parked vehicle (for example on a dead end street).

In these cases, you must maintain a safe braking distance, and if necessary, depress the brake pedal to reduce the driving speed in order to maintain a safe distance or to stop the vehicle.

Limitations of Forward Collision-Avoidance Assist

Forward Collision-Avoidance Assist is designed to assist driver in highly

dangerous driving situation and has not responsibility to all kind of situations.

Forward Collision-Avoidance Assist detects driving situations through radar signals and front view camera recognition and Forward Collision-Avoidance Assist may not operate normally in driving situation beyond radar signals and front view camera recognition performance. The driver must pay careful attention in the following situations where the Forward Collision-Avoidance Assist operation may not be operated properly.

Detecting vehicles

The sensor may be limited when:

- Starting engine or rebooting front view camera function wouldn't operate for 15 seconds.
- The front view camera is blocked with a foreign object or debris.
- The front view camera lens is contaminated due to tinted, filmed or coated windshield, damaged glass, or stuck of foreign matter (sticker, bug, etc.) on the glass.
- Inclement weather such as heavy rain or snow obscures the field of view of the front view camera.
- There is interference by electromagnetic waves.
- The front view camera sensor recognition is limited.

Driving your vehicle

- The vehicle in front is too small to be detected. (for example bicycle etc.)
- The front view camera does not recognize the entire vehicle in front.
- The vehicle in front is an oversize vehicle or trailer that is too big to be detected by the front view camera recognition function. (for example a tractor trailer, etc.)
- The front view camera's field of view is not well illuminated. (either too dark or too much reflection or too much backlight that obscures the field of view)
- The vehicle in front does not have their rear lights properly turned ON.
- The outside brightness changes suddenly. (for example when entering or exiting a tunnel)
- Light coming from a street light or an oncoming vehicle is reflected on a wet road surface such as a puddle in the road.
- Backlight is projected in the direction of the vehicle. (including opposite vehicle headlights)
- The field of view in front is obstructed by sun glare or head light of oncoming vehicle.
- The windshield glass is fogged up; a clear view of the road is obstructed.
- The vehicle in front is driving erratically The vehicle is on unpaved or uneven rough sur-

Forward Collision-Avoidance Assist (FCA) (Front view camera only)

- faces, or road with sudden gradient changes.
- In case of a vehicle in front is special vehicle, truck and trailer, etc. that contains a irregular form of luggage.
- The vehicle is severely shaken.
- In case of front view camera sensor recognition is in a marginal state.
- In case of be towed by a trailer or other vehicle.
- In case of interference caused by other electromagnetic waves.
- In case of a vehicle in front is driving erratically.
- In case of a vehicle in front has extremely high ground clearance.
- The vehicle drives inside a building, such as a basement parking lot.
- The front view camera is damaged.
- The brightness outside is too low such as when the headlamps are not on at night or the vehicle is going through a tunnel.
- The shadow is on the road by a median strip, trees, etc..
- The vehicle drives through a toll-gate.
- The rear part of the vehicle in front is not normally visible. (the vehicle turns in other direction or the vehicle is overturned.)
- The adverse road conditions cause excessive vehicle vibrations while driving.

- The sensor recognition changes suddenly when passing over a speed bump.
- The vehicle in front is moving vertically to the driving direction.
- The vehicle in front is stopped vertically.
- The vehicle in front is driving towards your vehicle or reversing.
- You are on a roundabout and the vehicle in front circles.

Detecting pedestrian

The sensor may be limited when:

- The pedestrian is not fully detected by the front view camera recognition function, for example, if the pedestrian is leaning over or is not fully walking upright.
- The pedestrian is moving very quickly or appears abruptly in the front view camera detection area.
- The pedestrian is wearing clothing that easily blends into the background, making it difficult to be detected by the front view camera.

Recognition function

- The sensor may be limited when: The outside lighting is too bright (e.g. when driving in bright sunlight or in sun glare) or too dark (e.g. when driving on a dark rural road at night).

- It is difficult to detect and distinguish the pedestrian from other objects in the surroundings, for example, when there is a group of pedestrians or a large crowd.
- There is an item similar to a person's body structure.
- The pedestrian is small.
- The pedestrian has impaired mobility. Never try to test the operation
- When the pedestrian suddenly interrupts in front of the vehicle.

Driving on a curved road

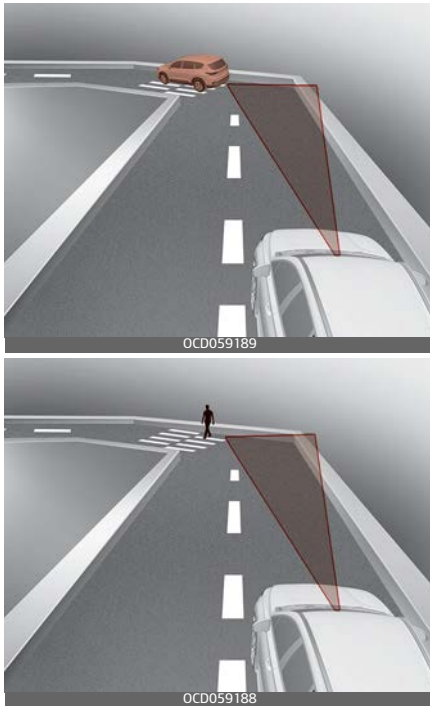

The performance of Forward Collision-Avoidance Assist may be limited when driving on a curved road.

On curved roads, the other vehicle on the same lane is not recognized and the performance of Forward Collision-Avoidance Assist may be degraded. This may result in unnecessary alarm or braking or no alarm or braking when necessary.

Also, in certain instances the front view camera recognition function may not detect the vehicle traveling on a curved road.

In these cases, the driver must maintain a safe braking distance, and if necessary, depress the brake pedal to reduce your driving speed in order to maintain a safe distance.

Forward Collision-Avoidance Assist may recognize a vehicle in the next lane when driving on a curved road.

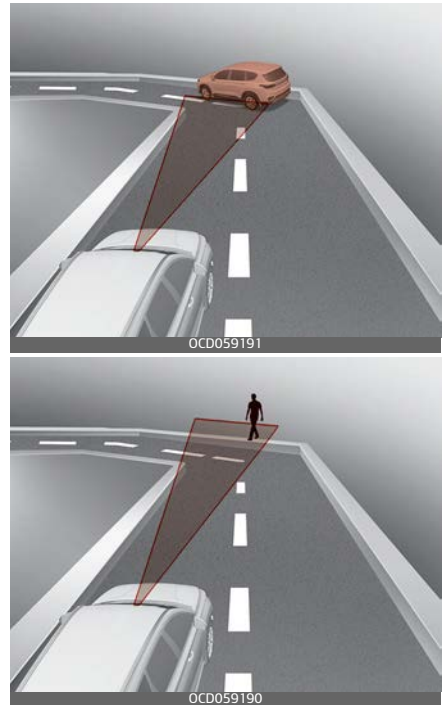

In this case, the function may unnecessarily alarm the driver and apply the brake.

Always pay attention to road and driving conditions, while driving. If necessary, depress the brake pedal to reduce your driving speed in order to maintain a safe distance.

Driving your vehicle

Also, when necessary depress the accelerator pedal to prevent the function from unnecessarily decelerating your vehicle.

Check to be sure that the road conditions permit safe operation of Forward Collision-Avoidance Assist.

Driving on a slope



The performance of Forward Collision-Avoidance Assist decreases while driving upward or downward on a slope, not recognizing the vehicle in front in the same lane. It may unnecessarily produce the warning message and the warning alarm, or

Forward Collision-Avoidance Assist (FCA) (Front view camera only)

it may not produce the warning message and the warning alarm at all.

When Forward Collision-Avoidance Assist suddenly recognizes the vehicle in front while passing over a slope, you may experience sharp deceleration.

Always keep your eyes forward while driving upward or downward on a slope, and, if necessary, depress the brake pedal to reduce your driving speed in order to maintain distance.

Changing lanes

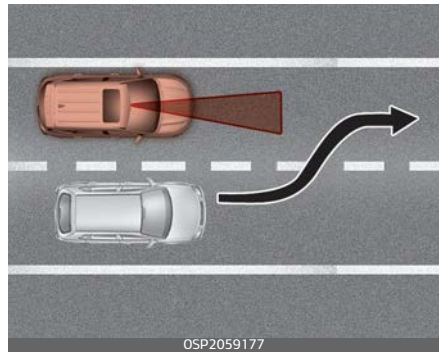

When a vehicle changes lanes in front of you, Forward Collision-Avoidance Assist may not immediately detect the vehicle, especially if the vehicle changes lanes abruptly. In this case, you must maintain a safe braking distance, and if necessary, depress the brake pedal to reduce your driving speed in order to maintain a safe distance.



When driving in stop-and-go traffic, and a stopped vehicle in front of you merges out of the lane, Forward Collision-Avoidance Assist may not immediately detect the new vehicle that is now in front of you. In this case, you must maintain a safe braking distance, and if necessary, depress the brake pedal to reduce your driving speed in order to maintain a safe distance.

Recognizing the vehicle

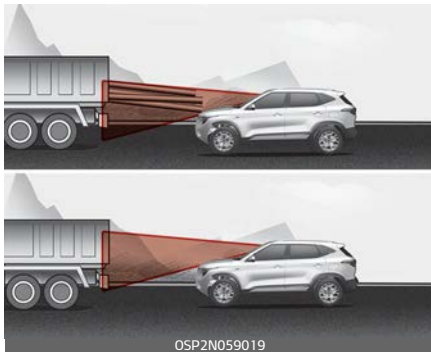

If the vehicle in front of you has cargo that extends rearward from the cab, or when the vehicle in front

of you has higher ground clearance, additional special attention is required. Forward Collision-Avoidance Assist may not be able to detect the cargo extending from the vehicle. In these instances, you must maintain a safe braking distance from the rearmost object, and if necessary, depress the brake pedal to reduce your driving speed in order to maintain distance.

⚠ WARNING

- Do not use Forward Collision-Avoidance Assist when towing a vehicle. Application of Forward Collision-Avoidance Assist while towing may adversely affect the safety of your vehicle or the towing vehicle.
- Use extreme caution when the vehicle in front of you has cargo that extends rearward from the cab, or when the vehicle in front of you has higher ground clearance.
- Forward Collision-Avoidance Assist may operate when an object, which has similar shape or characteristic to a vehicle or pedestrian, is detected.
- Forward Collision-Avoidance Assist is designed to detect and monitor the vehicle ahead in the roadway through front view camera recognition. It is not designed to detect pedestrian, bicycle,

motorcycle, or smaller wheeled objects such as luggage bags, shopping carts, or strollers.

- Never try to test the operation of Forward Collision-Avoidance Assist. Doing so may cause severe injury or death.
- If the front bumper, front glass, or front view camera have been replaced or repaired, you should have the vehicle inspected by an authorized Kia dealer.

*** NOTICE**

In some instances, Forward Collision-Avoidance Assist may be canceled when subjected to electromagnetic interference.

This device complies with Part 15 of the FCC rules.

Operation is subject to the following three conditions:

1. This device may not cause harmful interference, and
2. This device must accept any interference received, including interference that may cause undesired operation.
3. Changes or modifications not expressly approved by the party responsible for compliance could void the user's authority to operate the device.

Radio frequency radiation exposure information:

This equipment complies with FCC radiation exposure limits set forth for an uncontrolled environment.

This equipment should be installed and operated with minimum distance of 8 in (20 cm) between the radiator (antenna) and your body.

This transmitter must not be co-located or operating in conjunction with any other antenna or transmitter.

Forward Collision-Avoidance Assist (FCA) (Sensor fusion) (if equipped)

Basic function

Forward Collision-Avoidance Assist is designed to help detect and monitor the vehicle ahead or help detect a pedestrian or cyclist in the roadway and warn the driver that a collision is imminent with a warning message and an audible warning, and if necessary, apply emergency braking.

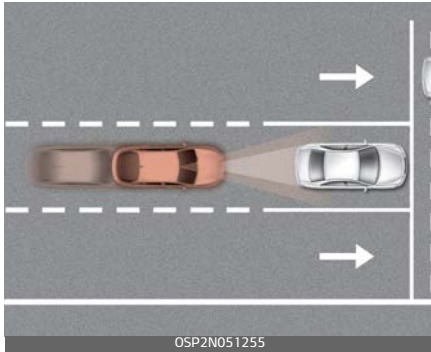

Junction Turning function (if equipped)

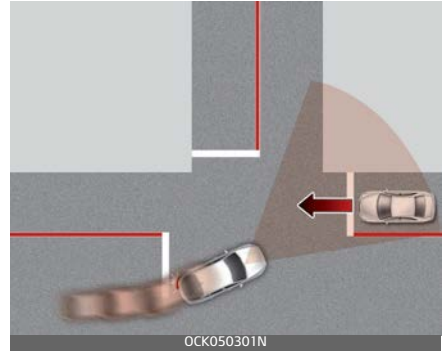

Junction Turning function will help avoid a collision with an oncoming vehicle in an adjacent lane when turning left at a crossroad with the turn signal on by applying emergency braking.

* NOTICE

FCA stands for Forward Collision-Avoidance Assist.

Detecting sensor

Front view camera



Front radar



Refer to the picture above for the detailed location of the detecting sensors.

⚠ CAUTION

Take the following precautions to maintain optimal performance of the detecting sensor:

- Never disassemble the detecting sensor or sensor assembly, or apply any impact on it.
- If the detecting sensors have been replaced or repaired, have

your vehicle inspected by an authorized Kia dealer.

- Never install any accessories or stickers on the front windshield, or tint the front windshield.
- Pay extreme caution to keep the front view camera dry.
- Never place any reflective objects (i.e. white paper, mirror) over the dashboard. Any light reflection may prevent the function from functioning properly.
- Do not apply license plate frame or objects, such as a bumper sticker, film or a bumper guard, near the front radar cover.
- Always keep the front radar and cover clean and free of dirt and debris. Use only a soft cloth to wash the vehicle. Do not spray pressurized water directly on the sensor or sensor cover.
- If unnecessary force has been applied to the radar or around the radar, Forward Collision-Avoidance Assist may not properly operate even though a warning message does not appear on the cluster. In this case, have your vehicle inspected by an authorized Kia dealer.
- Use only genuine parts to repair or replace a damaged front radar cover. Do not apply paint to the front radar cover.

Forward Collision-Avoidance Assist settings

Setting

Forward Safety



With the ignition switch or the ENGINE START/STOP button in the ON position, go to the 'User Settings → Driver Assistance → Forward Safety' from the setting menu to set whether or not to use each function.

- If 'Active Assist' is selected, the function will warn the driver with a warning message, an audible warning depending on the collision risk levels.
- If 'Warning Only' is selected, the function will warn the driver with a warning message, an audible warning depending on the collision risk levels.
- If 'Off' is selected, the function will off. The  warning light will illuminate on the cluster.

The driver can monitor Forward Collision-Avoidance Assist ON/OFF status from the Settings menu. If the  warning light remains ON when the function is ON, have the function checked by an authorized Kia dealer.

⚠ WARNING

- When the engine is restarted, Forward Collision-Avoidance Assist will always turn on.
- If 'Off' is selected from the Setting menu, the Forward Collision Assist will not operate so the driver should always be aware of the surroundings and drive safely.

⚠ CAUTION

- If 'Warning Only' is selected, braking is not assisted.
- The settings for Forward Safety function include 'Basic function' and 'Junction Turning'.

* NOTICE

Forward Collision-Avoidance Assist will turn off when ESC is turned off by pressing and holding the ESC OFF button and the  warning light will illuminate.

Warning Timing



With the ignition switch or the ENGINE START/STOP button in the ON position, go to the 'User Settings → Driver Assistance → Warning Timing' to change the initial warning activation time for Forward Collision-Avoidance Assist.

When the vehicle is first delivered, Warning Timing is set to 'Normal'. If you change the Warning Timing, the warning time of other Driver Assistance functions may change.

Warning Volume



With the ignition switch or the ENGINE START/STOP button in the ON position, go to the 'User Settings → Driver Assistance → Warning Volume' to change the Warning Volume to 'High', 'Medium', 'Low' for Forward Collision-Avoidance Assist.

If you change the warning volume, the Warning Volume of other Driver Assistance functions may change.

⚠ CAUTION

- The setting of the Warning Timing and Warning Volume applies to all functions of Forward Collision-Avoidance Assist.
- Even though 'Normal' is selected for Warning Timing, if the front vehicle suddenly stops, the initial warning activation time may not seem late.
- Select 'Late' for Warning Timing when traffic is light and when driving speed is slow.

* NOTICE

If the engine is restarted, Warning Timing and Warning Volume will maintain the last setting.

Forward Collision-Avoidance Assist operation

Basic function

Function warning and control

The basic function for Forward Collision-Avoidance Assist is to warn and control the vehicle depending on the collision level: 'Collision Warning', 'Emergency Braking', 'Emergency Braking complete'.

Collision Warning



- To warn the driver of a collision, the 'Collision Warning' warning message will appear on the cluster, an audible warning will sound.
- If a vehicle is detected in front, the function will operate when your vehicle speed is between approximately 6~110 mph (10~180 km/h).
- If a pedestrian or cyclist is detected in front, the function will operate when your vehicle speed

is between approximately 6~53 mph (10~85 km/h).

- If 'Active Assist' is selected, braking may be assisted.

Emergency Braking



- To warn the driver that emergency braking will be assisted, the 'Emergency Braking' warning message will appear on the cluster, an audible warning will sound.
- If a vehicle is detected in front, the function will operate when your vehicle speed is between approximately 6~47 mph (10~75 km/h).
- If a pedestrian or cyclist is detected in front, the function will operate when your vehicle speed is between approximately 6~40 mph (10~65 km/h).
- In emergency braking situation, braking is assisted with strong braking power by the function to help prevent collision with the vehicle, pedestrian or cyclist ahead.

Stopping vehicle and ending brake control



- When the vehicle is stopped due to emergency braking, the 'Emergency Braking complete' warning message will appear on the cluster.
- For your safety, the driver should depress the brake pedal immediately and check the surroundings.
- Brake control will end after the vehicle is stopped by emergency braking for approximately 2 seconds.

Junction Turning function

Function warning and control

Junction Turning function will warn and control the vehicle depending on the collision level: 'Collision Warning', 'Emergency Braking', 'Emergency Braking complete'.

Collision Warning



- To warn the driver of a collision, the 'Collision Warning' warning message will appear on the cluster, an audible warning will sound.
- The function will operate when your vehicle speed is between approximately 6~19 mph (10~30 km/h) and the oncoming vehicle speed is between approximately 19~44 mph (30~70 km/h).
- If 'Active Assist' is selected, braking may be assisted.

Emergency Braking



- To warn the driver that emergency braking will be assisted, the

'Emergency Braking' warning message will appear on the cluster, an audible warning will sound.

- The function will operate when your vehicle speed is between approximately 6~19 mph (10~30 km/h) and the oncoming vehicle speed is between approximately 19~44 mph (30~70 km/h).
- In emergency braking situation, braking is assisted with strong braking power by the function to help prevent collision with the oncoming vehicle.

Stopping vehicle and ending brake control



- When the vehicle is stopped due to emergency braking, the 'Emergency Braking complete' warning message will appear on the cluster.
- For your safety, the driver should depress the brake pedal immediately and check the surroundings.
- Brake control will end after the vehicle is stopped by emergency

braking for approximately 2 seconds.

⚠ WARNING

- For your safety, change the Settings after parking the vehicle at a safe location.
- With 'Active Assist' or 'Warning Only' selected, when ESC is turned off by pressing and holding the ESC OFF button, Forward Collision-Avoidance Assist will turn off automatically. In this case, the function cannot be set from the Settings menu and the warning light will illuminate on the cluster which is normal. If ESC is turned on by pressing the ESC OFF button, Forward Collision-Avoidance Assist will maintain the last setting.
- Forward Collision-Avoidance Assist does not operate in all situations or cannot avoid all collisions.
- The driver should hold the responsibility to control the vehicle. Do not solely depend on Forward Collision-Avoidance Assist. Rather, maintain a safe braking distance, and if necessary, depress the brake pedal to reduce driving speed or to stop the vehicle.
- Never deliberately operate Forward Collision-Avoidance Assist

on people, animal, objects, etc. It may cause serious injury or death.

- Forward Collision-Avoidance Assist may not operate if the driver depresses the brake pedal to avoid collision.
 - Depending on the road and driving conditions, Forward Collision-Avoidance Assist may warn the driver late or may not warn the driver.
 - During Forward Collision-Avoidance Assist operation, the vehicle may stop suddenly injuring passengers and shifting loose objects. Always have the seat belt on and keep loose objects secured.
 - If any other function's warning message is displayed or audible warning is generated, Forward Collision-Avoidance Assist warning message may not be displayed and audible warning may not be generated.
 - You may not hear the warning sound of Forward Collision-Avoidance Assist if the surrounding is noisy.
 - Forward Collision-Avoidance Assist may turn off or may not operate properly or may operate unnecessarily depending on the road conditions and the surroundings.
-

⚠ WARNING

- Even if there is a problem with Forward Collision-Avoidance Assist, the vehicle's basic braking performance will operate normally.
 - During emergency braking, braking control by the function will automatically cancel when the driver excessively depresses the accelerator pedal or sharply steers the vehicle.
-

⚠ CAUTION

- Depending on the condition of the vehicle, pedestrian and cyclist in front and the surroundings, the speed range to operate Forward Collision-Avoidance Assist may reduce. The function may only warn the driver, or the function may not operate.
 - It operates only under certain conditions by judging the danger according to a condition of the oncoming vehicle, driving direction, speed and the surrounding environment.
-

*** NOTICE**

In a situation collision is imminent, braking may be assisted by Forward Collision-Avoidance Assist when braking is insufficient by the driver.

Forward Collision-Avoidance Assist malfunction and limitations

Forward Collision-Avoidance Assist malfunction



When Forward Collision-Avoidance Assist is not working properly, the “Check Forward Collision-Avoidance Assist system” warning message will appear, and the and warning lights will illuminate on the cluster. In this case, have the vehicle inspected by an authorized Kia dealer.

Function disabled

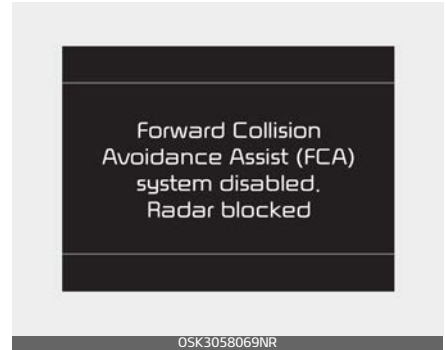
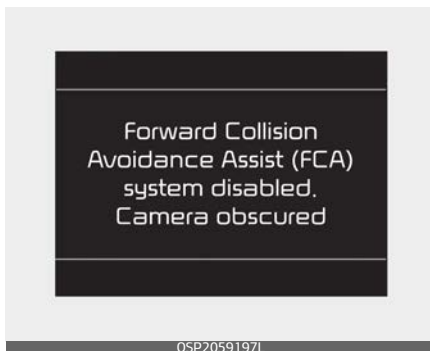

When the front windshield where the front view camera is located, front radar cover or sensor is covered with foreign material such as snow or rain, it can reduce the detecting performance and temporarily limit or disable Forward Collision-Avoidance Assist. If this occurs the ‘Forward Collision Avoidance Assist (FCA) system disabled. Radar blocked’ warning message, and the and warning lights will illuminate on the cluster.

The function will operate normally when snow, rain or foreign matter is removed. If the function does not operate normally after it is removed, have the vehicle inspected by authorized Kia dealer.

WARNING

- Even though the warning message or warning light does not appear on the cluster, Forward

Collision-Avoidance Assist may not properly operate.

- Forward Collision-Avoidance Assist may not properly operate in an area (e.g. open terrain), where any substance are not detected after turning ON the engine.
-

Limitations of Forward Collision-Avoidance Assist

Forward Collision-Avoidance Assist may not operate normally, or the function may operate unexpectedly under the following circumstances:

- The detecting sensor or the surroundings are contaminated or damaged.
- The temperature around the front view camera is high or low due to the external environment.
- The front view camera lens is contaminated due to tinted, filmed or coated windshield, damaged glass, or stuck of foreign matters (sticker, bug, etc.) on the glass.
- Moisture is not removed or frozen on the windshield.
- Washer fluid is continuously sprayed, or the wiper is on.
- Driving in heavy rain or snow, or thick fog.
- The field of view of the front view camera is obstructed by sun glare.

- Street light or light from an oncoming vehicle is reflected on the wet road surface, such as a puddle on the road.
- An object is placed on the dashboard.
- Your vehicle is being towed.
- The surrounding is very bright.
- The surrounding is very dark, such as in a tunnel, etc..
- The brightness changes suddenly, for example when entering or exiting a tunnel.
- The brightness outside is low, and the headlamps are not on or are not bright.
- Driving through steam, smoke or shadow.
- Only part of the vehicle, pedestrian or cyclist is detected.
- The vehicle in front is a bus, heavy truck, truck with a unusually shaped luggage, trailer, etc..
- The vehicle in front has no tail lights, tail lights are located unusually, etc..
- The brightness outside is low, and the tail lamps are not on or are not bright.
- The rear of the front vehicle is small or the vehicle does not look normal, such as when the vehicle is tilted, overturned, or the side of the vehicle is visible, etc..
- The front vehicle's ground clearance is low or high.
- A vehicle, pedestrian or cyclist suddenly cuts in front.

- The bumper around the front radar is impacted, damaged or the front radar is out of position.
- The temperature around the front radar is high or low.
- Driving through a tunnel or iron bridge.
- Driving in large areas where there are few vehicles or structures. (i.e. desert, meadow, suburb, etc.)
- Driving near areas containing metal substances, such as a construction zone, railroad, etc..
- A material is near that reflects very well on the front radar, such as a guardrail, nearby vehicle, etc..
- The cyclist in front is on a bicycle made of material that does not reflect on the front radar.
- The vehicle in front is detected late.
- The vehicle in front is suddenly blocked by an obstacle.
- The vehicle in front suddenly changes lane or suddenly reduces speed.
- The vehicle in front is bent out of shape.
- The front vehicle's speed is fast or slow.
- The vehicle in front steers in the opposite direction of your vehicle to avoid a collision.
- With a vehicle in front, your vehicle changes lane at low speed.
- The vehicle in front is covered with snow.
- You are departing or returning to the lane.
- You are driving unstably.
- You are on a roundabout and the vehicle in front is not detected.
- You are continuously driving in a circle.
- The vehicle in front has an unusual shape.
- The vehicle in front is driving uphill or downhill.
- The pedestrian or cyclist is not fully detected, for example, if the pedestrian is leaning over or is not fully walking upright.
- The pedestrian or cyclist is wearing clothing or equipment that makes it difficult to detect as a pedestrian or cyclist .

Following image shows the image the sensor recognizes as vehicle, pedestrian, and cyclist.



- The pedestrian or cyclist in front is moving very quickly.
- The pedestrian or cyclist in front is short or is posing a low posture.
- The pedestrian or cyclist in front has impaired mobility.

- The pedestrian or cyclist in front is moving intersected with the driving direction.
- There is a group of pedestrians, cyclists or a large crowd in front.
- The pedestrian or cyclist is wearing clothing that easily blends into the background, making it difficult to detect.
- The pedestrian or cyclist is difficult to distinguish from the similar shaped structure in the surroundings.
- You are driving by a pedestrian, cyclist traffic signs, structures, etc. near the intersection.
- Driving in a parking lot.
- Driving through a tollgate, construction area, unpaved road, partial paved road, uneven road, speed bumps, etc..
- Driving on an incline road, curved road, etc..
- Driving through a roadside with trees or streetlights.
- The adverse road conditions cause excessive vehicle vibrations while driving.
- Your vehicle height is low or high due to heavy loads, abnormal tire pressure, etc..
- Driving through a narrow road where trees or grass or overgrown.
- There is interference by electromagnetic waves, such as driving in an area with strong radio waves or electrical noise.

⚠ WARNING

• *Driving on a curved road*

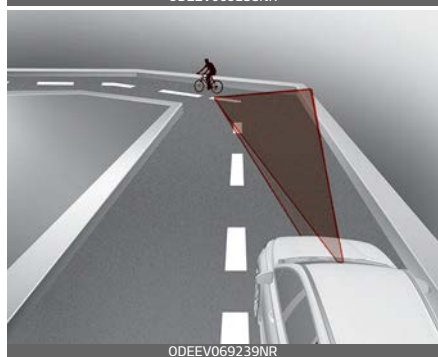
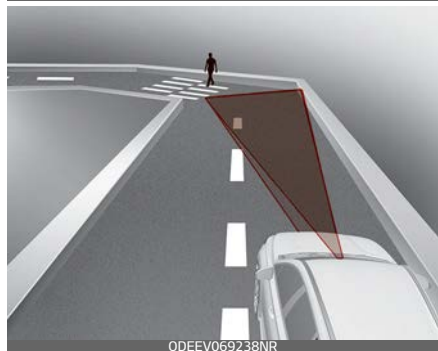

The front view camera or radar sensor recognition function may not detect the vehicle, pedestrian or

cyclist traveling in front on a curved road.

Always pay attention to road and driving conditions, and if necessary, depress the brake pedal to reduce your driving speed in order to maintain a safe distance.

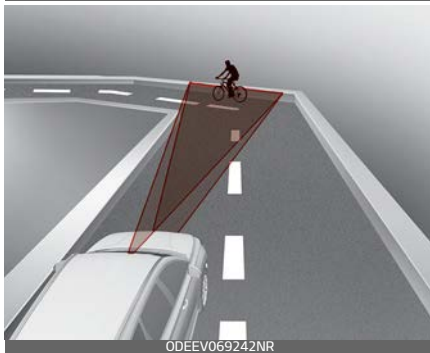
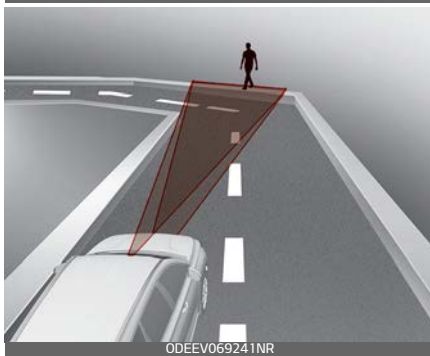
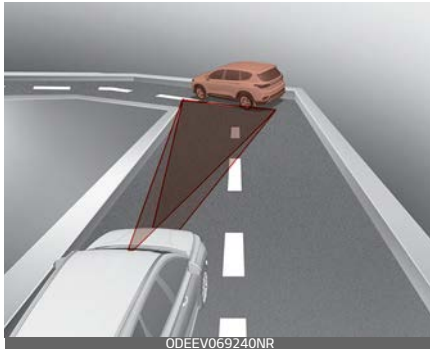

Forward Collision-Avoidance Assist may detect a vehicle or pedestrian in the next lane or outside the lane when driving on a curved road. If this occurs, the unnecessarily alarm the driver and apply the brake. Always check the traffic conditions around the vehicle.

• *Driving on a slope*





Forward Collision-Avoidance Assist may not detect other vehicle, pedestrian or cyclist in front while driving uphill or downhill and this may result in no warning, braking assist or steering assist when necessary.

When the function suddenly recognizes the vehicle, pedestrian or cyclist in front while passing over a slope, you may experience sharp deceleration.

Always keep your eyes forward while driving upward or downward on a slope, and, if necessary, depress the brake pedal to reduce your driving speed in order to maintain distance.

• *Changing lanes*

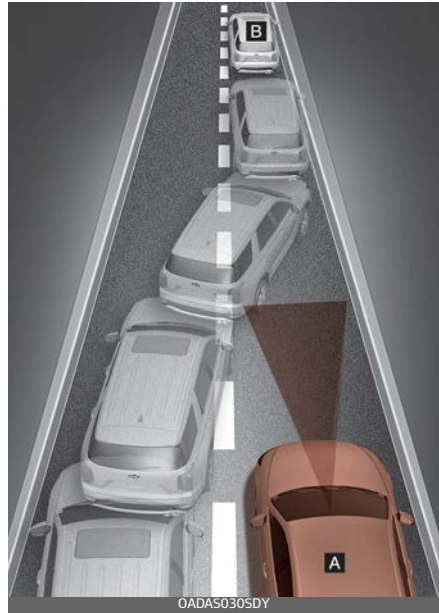

[A]: Your vehicle, [B]: Lane changing vehicle

When a vehicle changes lanes in front of you, Forward Collision-Avoidance Assist may not immediately detect the vehicle, especially if the vehicle changes lanes abruptly. In this case, you must maintain a safe braking distance, and if necessary, depress the brake pedal to reduce your driving speed in order to maintain a safe distance.

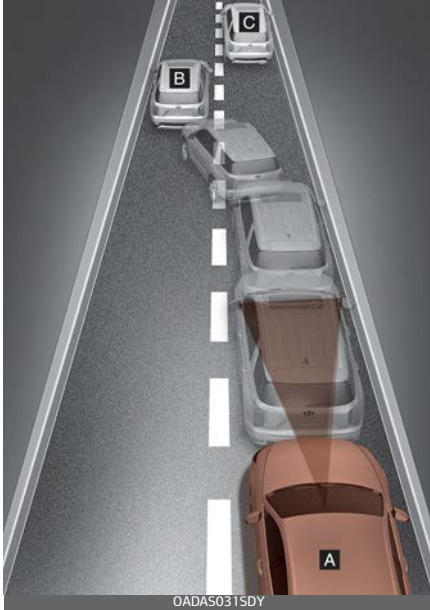

[A]: Your vehicle, [B]: Lane changing vehicle, [C]: Same lane vehicle

When driving in stop-and-go traffic, and a stopped vehicle in front of you merges out of the lane, Forward Collision-Avoidance Assist may not immediately detect the new vehicle that is now in front of you. In this case, you must maintain a safe braking distance, and if necessary, depress the brake pedal to reduce your driving speed in order to maintain a safe distance.

• **Recognizing the vehicle**

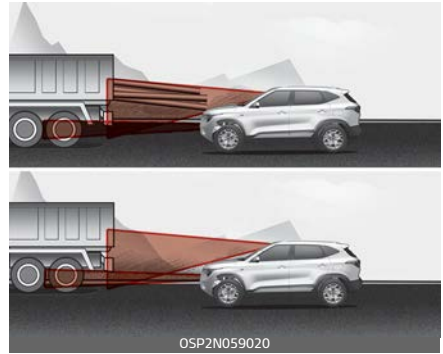

When the vehicle in front has heavy loading extended rearward, or when the vehicle in front has higher ground clearance, it may induce a hazardous situation. Always pay attention to road and driving conditions, while driving and, if necessary, depress the brake pedal to reduce your driving speed in order to maintain distance.

⚠ WARNING

- When you are towing a trailer or another vehicle, we recommend that Forward Collision-Avoidance Assist is turned off due to safety reasons.
- Forward Collision-Avoidance Assist may operate if objects that are similar in shape or characteristics to vehicles, pedestrian or cyclist are detected.

- Forward Collision–Avoidance Assist does not operate on bicycles, motorcycles, or smaller wheeled objects, such as luggage bags, shopping carts, or strollers that are dragged by a pedestrian or a cyclist.
 - Forward Collision–Avoidance Assist may not operate normally if interfered by strong electromagnetic waves.
 - Forward Collision–Avoidance Assist may not operate for 15 seconds after the vehicle is started, or the front view camera is initialized.
-

This device complies with Part 15 of the FCC rules.

Operation is subject to the following two conditions:

1. This device may not cause harmful interference, and
2. This device must accept any interference received, including interference that may cause undesired operation.

CAUTION TO USERS

Changes or modifications not expressly approved by the party responsible for compliance could void the user's authority to operate the equipment.

Radio frequency radiation exposure information:

This equipment complies with FCC radiation exposure limits set forth for an uncontrolled environment. This equipment should be installed and operated with minimum distance of 8 in (20 cm) between the radiator (antenna) and your body.

This transmitter must not be co-located or operating in conjunction with any other antenna or transmitter.

Lane Keeping Assist (LKA) (if equipped)

Lane Keeping Assist detects the lane markers on the road with a front view camera at the front windshield, and assists the driver's steering to help keep the vehicle in the lanes.

* NOTICE

LKA stands for Lane Keeping Assist.



When the function detects the vehicle straying from its lane, it warns the driver with a visual and audible warning, while applying a counter-steering torque, trying to prevent the vehicle from moving out of its lane.

⚠ WARNING

- Driver is responsible for being aware of surroundings and steering the vehicle for safe driving practices.

- Do not turn the steering wheel suddenly when the steering wheel is being assisted by the function.
- Lane Keeping Assist helps prevent the driver from moving out of the lane unintentionally by assisting the driver's steering. However, the function is just a convenience function and the steering wheel is not always controlled. While driving, the driver should pay attention to the steering wheel.
- The operation of Lane Keeping Assist can be cancelled or not work properly according to road condition and surroundings. Always be cautious when driving.

* NOTICE

- Do not disassemble a front view camera temporarily for window tinting or for attaching any types of coatings and accessories. If you disassemble the camera and assemble it again, take your vehicle to an authorized Kia dealer and have the function checked to see if it needs a calibration.
- When you replace the windshield glass, front view camera or related parts of the steering, take your vehicle to an authorized Kia dealer and have the function checked to see if it needs a calibration.

- The function detects lane markers and controls the steering wheel by a front view camera. Therefore, if the lane markers are hard to detect, the function may not work properly. Always be cautious when using the function.
- When the lane markers are hard to detect, please refer to "Limitations of Lane Keeping Assist" on page 5-111.
- Do not remove or damage parts of Lane Keeping Assist.
- Do not place objects on the dashboard that reflects light, such as mirrors, white paper, etc. It may cause the malfunctioning of Lane Keeping Assist if sunlight is reflected.
- You may not hear warning sounds of Lane Keeping Assist because of excessive audio sound.
- While other beeps, such as the seat belt warning sound, are in operation and override Lane Keeping Assist alarming function, Lane Keeping Assist beeps may not occur.
- If the vehicle speed is high, steering torque for assistance may not be enough to keep your vehicle within the lane. If so, the vehicle may move out of its lane. Obey speed limit when using Lane Keeping Assist.
- If you attach objects to the steering wheel, the function may not assist steering.

- If you attach objects to the steering wheel, hands off alarm may not work properly.

Lane Keeping Assist operation

To activate/deactivate Lane Keeping Assist:



With the ignition switch in the ON position, Lane Keeping Assist turns on automatically. The indicator () in the cluster display will initially illuminate white. This indicates Lane Keeping Assist is in the READY but NOT ENABLED state.

If you press the Lane Safety button located on the instrument panel on the lower left hand side of the driver, Lane Keeping Assist will be turned off and the indicator on the cluster display will go off.

The color of the indicator will change depending on the condition of Lane Keeping Assist.

- White: Sensor does not detect the lane marker or vehicle speed is less than 40 mph (64 km/h).
- Green: Sensor detects the lane marker and function is able to control the steering.

Lane Keeping Assist change



The driver can change Lane Keeping Assist to Lane Departure Warning or change Lane Keeping Assist mode from the LCD display or infotainment system display. Go to the 'User Settings → Driver Assistance → Lane Safety → Lane Keeping Assist/Lane Departure Warning/Off'.

If your vehicle is equipped with an infotainment system, you can learn how to setup on the website via QR code in the infotainment quick reference guide.

Lane Keeping Assist

This mode guides the driver to help keep the vehicle within the lanes. It rarely controls the steering wheel, when the vehicle drives well inside the lanes. However, it starts to control the steering wheel, when the vehicle is about to deviate out of the lane.

Lane Departure Warning

Lane Departure Warning warns the driver with a visual warning and a warning alarm when the function detects the vehicle departing the lane. The steering wheel will not be controlled.

Off

If you select 'Off', Lane Keeping Assist is deactivated.



Note that the vehicle speed must be at least approximately 40 mph (64 km/h) to ENABLE Lane Keeping Assist. The indicator in the cluster will illuminate green.

The color of indicator will change depending on the condition of Lane Keeping Assist.

- White: Sensor does not detect lane markers or vehicle speed is under 40 mph (64 km/h).

- Green: Sensor detects lane markers and the function is able to control vehicle steering.

*** NOTICE**

If the indicator (white) is activated from the previous ignition cycle, the function will turn ON without any additional control. If you press the Lane Safety button again, the indicator on the cluster goes off.

LKA operation



- To see Lane Keeping Assist screen on the LCD display in the cluster, select Driving Assist mode (). For more details, refer to "LCD Display Modes" on page 4-59. After Lane Keeping Assist is activated, if the lane markers are detected, vehicle speed is over 40 mph (64 km/h) and all the activation conditions are satisfied, a green steering wheel indicator will

illuminate and the steering wheel will be controlled.

⚠ WARNING

Lane Keeping Assist is a function to help prevent the driver from leaving the lane. However, the driver should not solely rely on the function but always check the road conditions and surroundings when driving.

Lane marker undetected



Lane marker detected



- If vehicle speed is over 40 mph (64 km/h) and the function detects

lane markers, the color of lanes changes from gray to white.

- Both lane markers must be detected for the function to fully activate.
- If your vehicle departs from the projected lane in front of you, Lane Keeping Assist operates as follows:



OSP2059129L



OSP2059130L

1. A visual warning appears on the cluster LCD display. Either the left lane marker or the right lane marker in the cluster LCD display will blink depending on which direction the vehicle is veering. Also, a warning sound will be heard.

2. Lane Keeping Assist will control the vehicle's steering to prevent the vehicle from crossing the lane marker in below conditions.

- Vehicle speed is over 40 mph (64 km/h)
- The function detects both lanes
- When driving, the vehicle is located between both lanes normally.
- The steering wheel is not turned suddenly.

When both lane markers are detected and all the conditions to activate Lane Keeping Assist are satisfied, a Lane Keeping Assist indicator light will change from white to green. This indicates that Lane Keeping Assist is in the ENABLED state and the steering wheel will be controlled.

Warning light and message

Keep hands on steering wheel



OSP2N051254L

If the driver takes their hands off the steering wheel for several seconds while Lane Keeping Assist is activated, the function will warn the driver.

⚠ WARNING

- The warning message may appear late according to road conditions. Therefore, always have your hands on the steering wheel while driving.
- If you hold the steering wheel lightly, the function may generate hands off warning.

⚠ WARNING

- The driver is responsible for accurate steering.
- Even though the steering is assisted by the function, the driver may control the steering wheel.
- Turn off the function and drive the vehicle in below situations.
 - In bad weather
 - In bad road condition
 - When the steering wheel needs to be controlled by the driver frequently.
 - When towing a vehicle or trailer.
- The steering wheel may feel heavier when the steering wheel is assisted by the function than when it is not.

Check Lane Keeping Assist (LKA) system



If there is a problem with the function, a message will appear for a few seconds. If the problem continues Lane Keeping Assist failure indicator will illuminate.

Lane Keeping Assist indicator

 Lane Keeping Assist indicator (yellow) will illuminate if Lane Keeping Assist is not working properly. You should have the vehicle inspected by an authorized Kia dealer.

When there is a problem with the function do one of the following:

- Turn the function on after turning the engine off and on again.
- Check if the ignition switch is in the ON position.
- Check if the function is affected by the weather. (e.g. fog, heavy rain, etc.)

- Check if there is foreign matter on the camera lens.

If the problem is not solved, you should have the vehicle inspected by an authorized Kia dealer.

Lane Keeping Assist will not be in the ENABLED state and/or the steering wheel will not be assisted when:

- The turn signal is turned on before changing a lane. If you change lanes without the turn signal on, the steering wheel might be controlled.
- The vehicle is not driven in the middle of the lane when the function is turned on or right after changing a lane.
- ESC (Electronic Stability Control) or VSM (Vehicle Stability Management) is activated.
- The vehicle is driven on a sharp curve.
- The steering will not be assisted when vehicle speed is below 40 mph (64 km/h). Always obey all traffic laws and drive safely.
- The steering will not be assisted when you change lanes quickly.
- The steering will not be assisted when you brake suddenly.
- The steering will not be assisted when the lane is very wide or narrow.
- There are more than two lane markers such as a construction area.

- Radius of a curve is too small.
- When you turn the steering wheel suddenly, Lane Keeping Assist will be disabled temporarily.
- Driving on a steep slope or hill.
- Starting the engine or initializing (or rebooting) the Front View Camera for about 15 seconds.

Limitations of Lane Keeping Assist

Lane Keeping Assist may operate prematurely even if the vehicle does not depart from the intended lane or, Lane Keeping Assist may not assist your steering or warn you if the vehicle leaves the intended lane under the following circumstances:

When the lane and road conditions are poor

- It is difficult to distinguish the lane marker from road when the lane marker is covered with dust or sand.
- It is difficult to distinguish the lane marking from the road surface or the lane marking is faded or not clearly marked.
- It is difficult to distinguish the color of the lane marker from the road.
- There are markings on the road surface that look like a lane marker that is inadvertently being detected by the camera.
- The lane marker is indistinct or damaged.

- The lane marker is merged or divided (e.g. tollgate).
- The lane number increases or decreases or the lane marker are crossing complicatedly.
- There are more than two lane markers on the road in front of you.
- The lane marker is very thick or thin.
- The lane is very wide or narrow.
- The lanes ahead are not visible due to rain, snow, water on the road, damaged or stained road surface, or other factors.
- The shadow is on the lane marker by a median strip, trees, guardrail, noise barriers, etc.
- The lane markers are complicated or a structure substitutes for the lines such as a construction area.
- There are crosswalk signs or other symbols on the road.
- The lane marker in a tunnel is stained with oil, etc.
- The lane suddenly disappears such as at the intersection.
- There is a boundary structure in the roadway such as a concrete barrier, guardrail and reflector post that is inadvertently being detected by the front view camera.
- When light coming from a street light or an oncoming vehicle is reflected on a wet road surface such as a puddle in the road.
- Road surface is not evenness.
- The distance from the vehicle ahead is very short or the vehicle ahead drives hiding the lane line.
- The field of view in front is obstructed by sun glare.
- There is not enough distance between you and the vehicle in front to be able to detect the lane marker or the vehicle ahead is driving on the lane marker.
- Driving on a steep grade, over a hill, or when driving on a curved road.
- The adverse road conditions cause excessive vehicle vibrations while driving.
- The surrounding of the inside rear view mirror temperature is high due to direct sunlight, etc.

When external condition is intervened

- The brightness outside changes suddenly such as when entering or exiting a tunnel, or when passing under a bridge.
- The brightness outside is too low such as when the headlamps are not on at night or the vehicle is going through a tunnel.

When front visibility is poor

- The windshield or the camera lens is covered by strange materials.
- The windshield glass is fogged up; a clear view of the road is obstructed.
- Placing objects on the dashboard, etc.
- The front view camera cannot detect the lane because of fog, heavy rain or snow.

⚠ WARNING

Lane Keeping Assist is a function designed to help prevent the driver from leaving the lane. However, the driver should not solely rely on the function but always take the necessary actions for safe driving practices.

Blind-Spot Collision-Avoidance Assist (BCA) (if equipped)

Blind-Spot Collision-Avoidance Assist detects approaching vehicles in the blind-spot and warns the driver.

Blind-Spot Collision-Avoidance Assist description***Blind-Spot Collision Warning***

Blind-Spot Collision Warning uses radar sensors in the rear bumper to monitor and warn the driver of an approaching vehicle in the driver's blind spot area.

1. Blind-Spot area

The blind spot detection range varies relative to vehicle speed. Note that if your vehicle is traveling much faster than the vehicles around you, the warning will not occur.

Closing at high speed



Blind-Spot Collision Warning will warn you when it detects a vehicle is approaching in an adjacent lane at a high rate of speed.

If the driver activates the turn signal when the function detects an oncoming vehicle, the function sounds an audible warning.

Blind-Spot Collision-Avoidance Assist

Blind-Spot Collision-Avoidance Assist detects the front lane through the front view camera installed on the upper front windshield and detects the side/rear areas through rear corner radars.

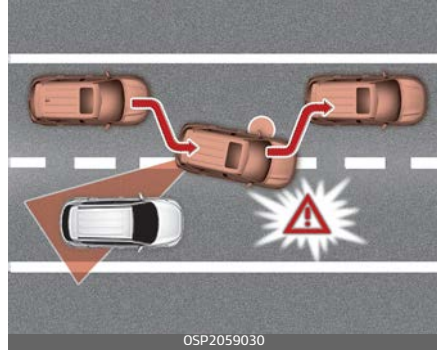

Blind-Spot Collision-Avoidance Assist may activate the differential braking. In accordance with a colliding possibility with an approaching vehicle while changing lanes. It is to lower the colliding risk or mitigate the colliding damage.

WARNING

- Always be aware of road conditions while driving and be alert for unexpected situations even though Blind-Spot Collision-Avoidance Assist is operating.
- Blind-Spot Collision-Avoidance Assist are supplemental functions to assist you. Do not rely entirely on the functions. Always pay attention, while driving, for your safety.
- Blind-Spot Collision-Avoidance Assist are not substitutes for proper and safe driving. Always drive safely and use caution when changing lanes or backing up the vehicle.

Blind-Spot Collision-Avoidance Assist may not detect every object alongside the vehicle.

Blind-Spot Collision-Avoidance Assist setting and activation

Blind-Spot Collision-Avoidance Assist setting



The driver can activate the function by placing the ignition switch to the ON position and by selecting 'User Settings → Driver Assistance → Blind-Spot Safety'. If your vehicle is equipped with an infotainment system, you can learn how to setup on the website via QR code in the infotainment quick reference guide.

- If 'Active Assist' is selected, the function will warn the driver with a warning message, an audible warning and braking assist will be applied depending on the collision risk levels.
- If 'Warning Only' is selected, the function will warn the driver with

a warning message, an audible warning depending on the collision risk levels. Braking will not be assisted.

- If you select "Off", Blind-Spot Collision-Avoidance Assist deactivates.

If the engine is turned off then on again, the function maintains the previous state.

Warning Timing



The driver can select the initial warning activation time in the User Settings in the LCD display or infotainment system display by selecting 'User Settings → Driver Assistance → Warning Timing'.

The options for the initial Blind-Spot Collision Warning includes the following:

- Normal: When this condition is selected, the initial Blind-Spot Collision Warning is activated normally. If this setting feels sensitive change the option to 'Late'.

The warning activation time may feel late if a vehicle at the side or rear abruptly accelerates.

- Late: Select this warning activation time when the traffic is light and you are driving in a low speed.

*** NOTICE**

If you change the warning timing, the warning time of other functions may change. Always be aware before changing the warning timing.

Warning Volume

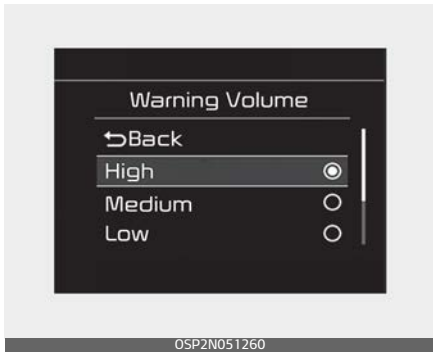

The driver can select the warning volume of Blind-Spot Collision-Avoidance Assist in the User Settings in the LCD display or infotainment system display by selecting 'User Settings → Driver Assistance → Warning Volume → High/Medium/Low'.

*** NOTICE**

If you change the warning volume, the warning volume of other functions may change. Always be aware before changing the warning volume.

Operating Conditions

The function enters the ready status, when 'Active Assist' or 'Warning Only' is selected and the following conditions are satisfied:

Active Assist

1. Collision-Avoidance Assist will activate when:
 - Vehicle speed is between 40 ~ 110 mph (60~180 km/h).
 - The function detects both of the lane lines.
 - An approaching vehicle is detected next to or behind your vehicle.
2. Collision Warning will activate when:
 - The vehicle speed is above about 20 mph (30 km/h).

Warning Only

1. Collision Warning will activate when:
 - The vehicle speed is above 20 mph (30 km/h).

* If 'Warning Only' is selected, braking is not assisted.

Warning and Blind-Spot Collision-Avoidance Assist control

Collision Warning

1st stage



If a vehicle is detected within the boundary of the function, a warning light will illuminate on the outside rear view mirror.

Once the detected vehicle is no longer within the blind spot area, the warning will turn off according to the driving conditions of the vehicle.

2nd stage



[A]: Warning sound

A warning chime to warn the driver will activate when:

1. A vehicle has been detected in the blind spot area by the radar AND.
2. The turn signal is applied (same side as where the vehicle is being detected).

When this warning is activated, the warning light on the outside rear view mirror will blink. And a warning chime will sound.

If you turn off the turn signal indicator, the second stage warning will be deactivated.

Once the detected vehicle is no longer within the blind spot area, the warning will turn off according to the driving conditions of the vehicle.

⚠ WARNING

- The warning light on the outside rearview mirror will illuminate whenever a vehicle is detected at the rear side by the function.

To avoid accidents, do not focus only on the warning light and neglect to see the surrounding of the vehicle.

- Drive safely even though the vehicle is equipped with Blind-Spot Collision-Avoidance Assist. Do not rely solely on the function but check your surroundings before changing lanes or backing the vehicle up.
- The function may not warn the driver in some conditions so always check your surroundings while driving.
- The driver should always use extreme caution while operating the vehicle, whether or not the warning light on the outside rear-view mirror illuminates or there is a warning alarm.

⚠ CAUTION

- Playing the vehicle audio system at high volume may offset Blind-Spot Collision-Avoidance Assist warning sounds.
- The warning of Blind-Spot Collision-Avoidance Assist may not sound while other function's warning sounds are in use.

Collision-Avoidance Assist

Blind-Spot Collision-Avoidance Assist may apply braking power,

when an approaching vehicle is detected within a certain distance next to or behind your vehicle.

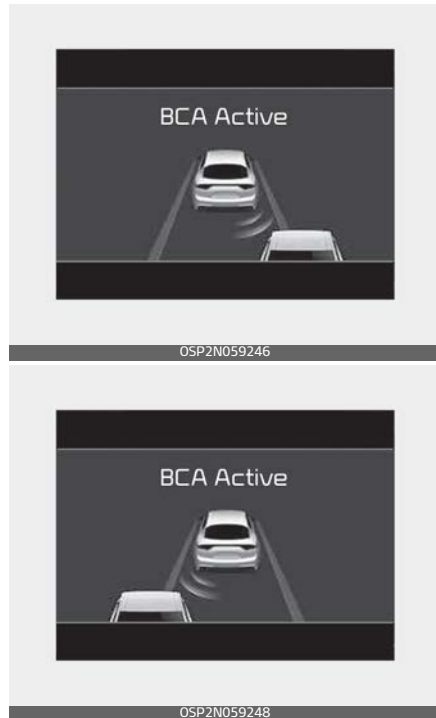

Blind-Spot Collision-Avoidance Assist gently applies braking power on the tire that is located in the opposite side of the possibly-colliding point. The instrument cluster will inform the driver of the Blind-Spot Collision-Avoidance Assist activation.

Blind-Spot Collision-Avoidance Assist is automatically deactivated when:

- The vehicle drives a certain distance away.

- The vehicle direction is changed against the possible-colliding point.
- The steering wheel is abruptly moved.
- The brake pedal is depressed.
- After a certain period of time.

The driver should drive the vehicle in the middle of the vehicle lanes to keep the function in the ready status. When the vehicle drives too close to one side of the vehicle lanes, the function may not properly operate.

In addition, the function may not properly control your vehicle in accordance with driving situations. Thus, always pay close attention to road situations.

⚠ WARNING

- The driver is responsible for safe driving.
- Do not unnecessarily operate the steering wheel, when Blind-Spot Collision-Avoidance Assist is in operation.
- Always pay special attention while driving. Blind-Spot Collision-Avoidance Assist may not operate or unnecessarily operate depending on road and traffic conditions.
- Blind-Spot Collision-Avoidance Assist is not a substitute for safe driving practices, but a convenience function only. It is the

responsibility of the driver to always drive cautiously to prevent unexpected and sudden situations from occurring. Pay attention to the road conditions and surroundings at all times.

Detecting sensors

Front view camera



The front view camera is a sensor detecting the lane. If the sensors are covered with snow, rain or foreign substance, the function may temporarily be canceled and not work properly. The function may also be canceled due to the degradation of the sensor's detection performance. Always keep the sensor clean.

Refer to "Lane Keeping Assist (LKA) (if equipped)" on page 5-105 for cautions for the front view camera.

Rear corner radar



The rear corner radars are the sensors inside the rear bumper for detecting the side and rear areas. Always keep the rear bumper clean for proper operation of the function.

⚠ CAUTION

- The function may not work properly when the bumper has been damaged, or if the rear bumper has been replaced or repaired.
- The sensing range differs somewhat according to the width of the road. When the road is narrow, the function may detect other vehicles in the next lane.
- The function may turn off due to strong electromagnetic waves.
- Always keep the sensors clean.
- NEVER disassemble the sensor component nor apply any impact on the sensor component.
- Be careful not to apply unnecessary force on the radar sensor or sensor cover. If the sensor is forc-

ibly moved out of proper alignment, the function may not operate correctly. In this case, a warning message may not be displayed.

Have the vehicle inspected by an authorized Kia dealer.

- Do not apply foreign objects such as a bumper sticker or a bumper guard near the radar sensor or apply paint to the sensor area. Doing so may adversely affect the performance of the sensor.
- NEVER install any accessories or stickers on the front windshield, nor tint the front windshield.
- Pay special attention to keep the camera sensor out of water.
- NEVER place any reflective objects (i.e., white paper, mirror) over the crash pad. Any light reflection may cause a malfunction of the function.

Warning message**Blind-Spot Collision Warning (BCW) system disabled. Radar blocked**

This warning message may appear when:

- One or both of the sensors on the rear bumper is blocked by dirt or snow or a foreign object.
- Driving in rural areas where the sensor does not detect another vehicle for an extended period of time.
- When there is inclement weather such as heavy snow or rain.

If any of these conditions occur, the function will turn off automatically.

When BCW canceled warning message is displayed in the cluster, check to make sure that the rear bumper is free from any dirt or snow in the areas where the radar sensors are located. Remove any dirt, snow, or foreign material that could interfere with the radar sensors.

After any dirt or debris is removed, the function should operate normally after about 10 minutes of driving the vehicle.

If Blind-Spot Collision-Avoidance Assist still does not operate normally, have your vehicle inspected by an authorized Kia dealer.

*** NOTICE**

Turn off Blind-Spot Collision-Avoidance Assist and Rear Cross-Traffic Collision-Avoidance Assist when a trailer or carrier is installed.

- Deactivate the Blind-Spot Collision-Avoidance Assist by selecting "User Settings → Driver Assistance → Blind-Spot Safety → Off".
- Deactivate Rear Cross-Traffic Collision-Avoidance Assist by deselecting "User Settings → Driver Assistance → Parking safety → Rear Cross-Traffic Safety".

If your vehicle is equipped with an infotainment system, you can learn how to setup on the website via QR code in the infotainment quick reference guide.

Check Blind-Spot Collision Warning system

Type A



OSP2041144L

Type B

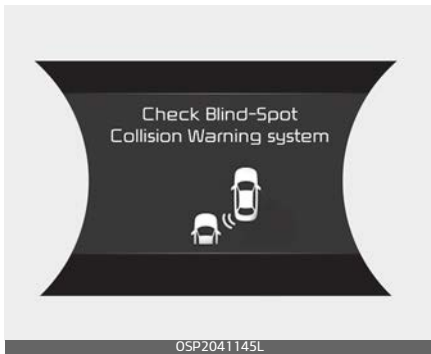

OSP2041145L

If there is a problem with BCW, a warning message will appear. The function will turn off automatically. BCA will not operate also if BCW turns off due to malfunction. You should have the vehicle inspected by an authorized Kia dealer.

Check Blind-Spot Collision-Avoidance Assist (BCA)

Type A

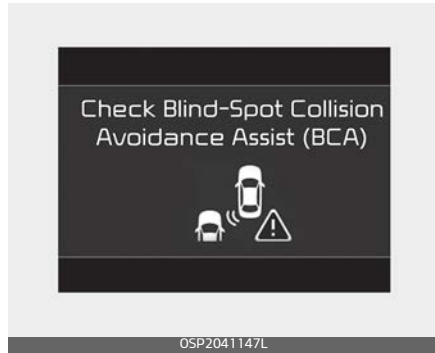

OSP2041147L

Type B



OSP2041146L

If there is a problem with BCA, a warning message will appear. The function will turn off automatically. You should have the vehicle inspected by an authorized Kia dealer.

Limitations of the Blind-Spot Collision-Avoidance Assist

The driver must be cautious in the below situations, because the func-

tion may not detect other vehicles or objects in certain circumstances.

- The function may not work around 15 seconds after starting the vehicle or the initialization or rebooting of the front view camera.
- When a trailer or carrier is installed.
- The vehicle drives in inclement weather such as heavy rain or snow.
- The sensors are polluted with rain, snow, mud, etc.
- The rear bumper where the sensors are located is covered with a foreign object such as a bumper sticker, a bumper guard, a bike rack, etc.
- The rear bumper is damaged, or the sensors are out of the original default position.
- The vehicle height gets lower or higher due to heavy loading in a liftgate, abnormal tire pressure, etc.
- When the temperature of the rear bumper is high.
- When the sensors are blocked by other vehicles, walls or parking-lot pillars.
- The vehicle drives on a curved road.
- The vehicle drives through a toll-gate.
- The road pavement (or the peripheral ground) abnormally contains metallic components (i.e. possibly due to subway construction).
- There is a fixed object near the vehicle, such as a guardrail, pedestrian, animals or tunnel, etc.
- While going down or up a steep road where the height of the lane is different.
- Driving on a narrow road where trees or grass or overgrown.
- Driving in rural areas where the sensor does not detect another vehicle or structure for an extended period of time.
- Driving on a wet road.
- Driving on a road where the guardrail or wall is in double structure.
- A big vehicle is near such as a bus or truck.
- When the other vehicle approaches very close.
- When the other vehicle passes at a very fast speed.
- While changing lanes.
- If the vehicle has started at the same time as the vehicle next to you and has accelerated.
- When the vehicle in the next lane moves two lanes away from you OR when the vehicle two lanes away moves to the next lane from you.
- A motorcycle or bicycle is near.
- A flat trailer is near.
- If there are small objects in the detecting area such as a shopping cart or a baby stroller.

- If there is a low height vehicle such as a sports car.
- The brake pedal is depressed.
- ESC (Electronic Stability Control) is activated.
- ESC (Electronic Stability Control) malfunctions.
- The tire pressure is low or a tire is damaged.
- The brake is reworked.
- The vehicle abruptly changes driving direction.
- The vehicle makes sharp lane changes.
- The vehicle sharply stops.
- Temperature is extremely low around the vehicle.
- The vehicle severely vibrates while driving over a bumpy road, uneven/bumpy road, or concrete patch.
- The vehicle drives on a slippery surface due to snow, water puddle, or ice.
- Lane Keeping Assist does not operate normally. (if equipped)
- For more details, refer to "Lane Keeping Assist (LKA) (if equipped)" on page 5-105.

Driving on a curved road



BCA may not operate properly when driving on a curved road. In certain instances, the function may not detect the vehicle in the next lane.

Always pay attention to road and driving conditions, while driving.

BCA may not operate properly when driving on a curved road. In certain instances, the function may recognize a vehicle in the same lane.



Always pay attention to road and driving conditions, while driving.

Driving where the road is merging/dividing

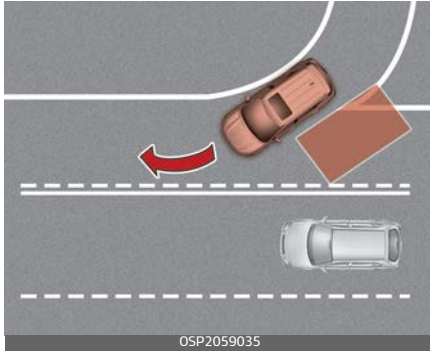

BCA may not operate properly when driving where the road is merging/dividing. In certain instances, the function may not detect the vehicle in the next lane.

Always pay attention to the road and driving conditions, while driving.

Driving on a slope

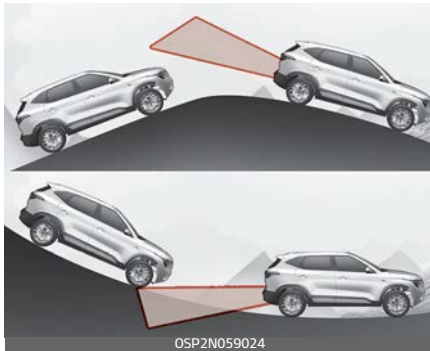

BCA may not operate properly when driving on a slope. In certain instances the function may not detect the vehicle in the next lane.

Also, in certain instances, the function may wrongly recognize the ground or structures.

Always pay attention to the road and driving conditions, while driving.

Driving where the heights of the lanes are different



BCA may not operate properly when driving where the heights of the lanes are different.

In certain instances, the function may not detect the vehicle on a road with different lane heights (i.e. underpass joining section, grade separated intersections, etc.).

Always pay attention to the road and driving conditions, while driving.

Driving where there is a structure beside the road



[A] : Noise barrier, [B] : Guardrail

BCA may not operate properly when driving where there is structure beside the road.

In certain instances, the function may wrongly recognize the structures (i.e. noise barriers, guardrail, double guardrail, median strip, bollard, street light, road sign, tunnel wall, etc.) beside the road.

Always pay attention to the road and driving conditions, while driving.

This device complies with Part 15 of the FCC rules.

Operation is subject to the following two conditions:

1. This device may not cause harmful interference, and
2. This device must accept any interference received, including interference that may cause undesired operation.

Driver Attention Warning (DAW) (if equipped)

Driver Attention Warning displays the level of the driver's fatigue and inattention, considering the driving pattern, etc.

Driver Attention Warning setting and operation

Driver Attention Warning setting



- To turn ON Driver Attention Warning, turn on the engine, and then select "User Settings → Driver Assistance → Driver Attention Warning → Inattentive Driving Warning" on the LCD display or infotainment system display. If your vehicle is equipped with an infotainment system, you can learn how to setup on the website via QR code in the infotainment quick reference guide.
- The set-up of Driver Attention Warning will be maintained, as

selected, when the engine is re-started.

Warning Timing



The driver can select the initial warning activation time in the User Settings in the LCD display or infotainment system display by selecting 'User Settings → Driver Assistance → Warning Timing'. The options for the initial Inattentive Warning Timing includes the following:

- Late: Driver Attention Warning helps warn the driver of his/her fatigue level or inattentive driving practices later than Normal mode.

*** NOTICE**

Other driver assistance functions like Forward Collision-Avoidance Assist, etc. can be changed when warning time setting is changed.

Display of the driver's attention level

Off

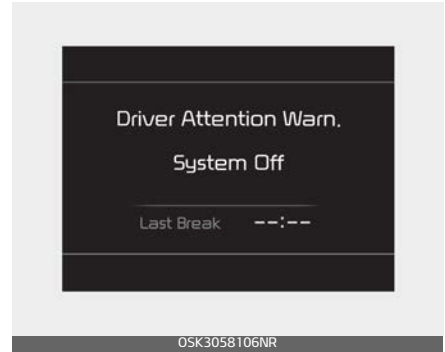

Attentive driving



Inattentive driving



- The driver can monitor his/her driving conditions on the cluster LCD display.
Driver Attention Warning screen will appear when you select the Driving Assist mode tab () on the LCD display if the function is activated. For more details, refer to "LCD Display Modes" on page 4-59.
- The driver's attention level is displayed on the scale of 1 to 5. The lower the level is, the more inattentive the driver is.
- The level decreases when the driver does not take a break for a certain period of time.
- The level increases when the driver attentively drives for a certain period of time.
- When the driver turns on the function while driving, it displays 'Last Break time' and level.

Taking a break

The "Consider taking a break" message appears on the LCD display and a warning sounds to suggest that the driver take a break when the driver's attention level is below 1.



Driver Attention Warning will not suggest a break when the total driving time is shorter than 10 minutes.

CAUTION

While other beeps, such as the seat belt warning sound, are in operation and override Driver Attention Warning alarming function, Driver Attention Warning beeps may not occur.

Resetting Driver Attention Warning

The last break time is set to 00:00 and the driver's attention level is set to 5 (very attentive) when the driver resets Driver Attention Warning.

Driver Attention Warning resets in the following situations.

- The engine is turned OFF.
- The driver unfastens the seat belt and then opens the driver's door.
- Stop lasting more than 10 minutes.

Driver Attention Warning operates again, when the driver restarts driving.

Driver Attention Warning standby



Driver Attention Warning enters the ready status and displays the 'Standby' screen in the following situations.

- The camera sensor is unable to detect the lanes.
- Driving speed remains over 110 mph (180 km/h).

Driver Attention Warning malfunction

When the "Check Driver Attention Warning (DAW) system" warning message appears, Driver Attention Warning is not working properly.

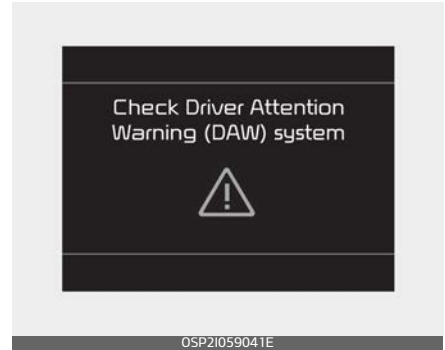

In this case, take your vehicle to an authorized Kia dealer and have the function checked.

⚠ WARNING

- Driver Attention Warning is not a substitute for safe driving practices. It is the responsibility of the driver to always drive cautiously to prevent unexpected and sudden situations from occurring. Pay attention to the road conditions and surroundings at all times.
- The function may suggest a break according to the driver's driving pattern or habits, even if the driver doesn't feel fatigued.
- A driver, who feels fatigued, should take a break, even though there is no break suggestion by Driver Attention Warning.

*** NOTICE**

- Driver Attention Warning utilizes the camera sensor on the front windshield for its operation.
 - To keep the camera sensor in the best condition, you should observe the followings:
 - Do not disassemble camera temporarily for tinting windows or for attaching any types of coatings and accessories. If you disassemble a camera and assemble it again, take your vehicle to an authorized Kia dealer and have the function checked to see if it needs a calibration.
 - Do not place any reflective objects (i.e., white paper, mirror) over the dashboard. Any light reflection may prevent Driver Attention Warning from functioning properly.
 - Use extreme caution to keep the camera sensor out of water.
 - Do not disassemble the camera assembly, or apply any impact on the camera assembly.
 - Playing the vehicle audio system at high volume may offset Driver Attention Warning warning sounds.
-

⚠ CAUTION

Driver Attention Warning may not provide warning in the following situations:

- Not properly recognize lane. (For more information, refer to "Lane Keeping Assist (LKA) (if equipped)" on page 5-105.)
 - Rough or intentionally evasive driving (road construction, nearby vehicles, falling object, bump in the road, etc.).
 - When the driving performance of the vehicle deteriorates (Large tire pressure deviation, uneven wear, poor wheel alignment, etc.).
 - Severe winding road.
 - Uneven road surface condition.
 - Windy road.
 - The vehicle drives through a windy area.
 - The vehicle is controlled by the following driver assistance functions:
 - Forward Collision-Avoidance Assist.
 - Lane Keeping Assist
 - Blind-Spot Collision-Avoidance Assist
 - Smart Cruise Control
 - Lane Following Assist
 - Highway Driving Assist
-

Leading Vehicle Departure Alert

Leading vehicle departure alert function warns the driver of the departure of the vehicle in front when the vehicle is stopped.

Function setting

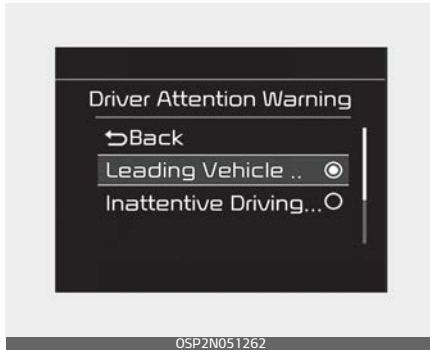

With the engine ON, Leading Vehicle Departure Alert turns on and gets ready to be activated when the 'User Settings → Driver Assistance → Driver Attention Warning → Leading vehicle departure alert' is selected on the cluster. If your vehicle is equipped with an infotainment system, you can learn how to setup on the website via QR code in the infotainment quick reference guide. The function stops operation when the setting is deactivated. However, if the engine is turned off then on again, the function maintains the previous state.

Operating conditions



After the vehicle in front departs, the message is displayed on the cluster with the alarm.

⚠ WARNING

- Leading vehicle departure alert function is assist equipment for the driver, and the function may not sound the alarm even the vehicle in front departs.
- Even though the function allows the driver recognize the departure of the vehicle in front, the driver should always be aware of the surroundings and operate the vehicle with the driver's own decisions.

⚠ CAUTION

- Leading vehicle departure alert function uses the front view camera. To optimize the function of the front view camera, the driver should manage it carefully. For

detailed information, please refer to the warning statements in "Lane Keeping Assist (LKA) (if equipped)" on page 5-105.

- Leading Vehicle Departure Alert will not be in the ENABLED state when:
 - There is a passenger or a bicycle in front of the vehicle.
 - A vehicle moves into your lane from an adjacent lane.
 - The vehicle in front departs suddenly or makes a U-turn.
 - The vehicle stops on a speed bump or on a slope.
 - The vehicle stops during turning right or driving on a curve.
 - The traffic condition is complicate such as a lane drop section.
 - The vehicle stops on the shoulder, rest area or parking lots.
 - The function may not work around 15 seconds after starting the vehicle or the initialization or rebooting of the front view camera.

WARNING

Always check the front of the vehicle and road conditions before departure.

Cruise Control (CC) (if equipped)

Cruise Control allows you to program the vehicle to maintain a constant speed without pressing the accelerator pedal.

This function is designed to function above approximately 20 mph (30 km/h).

- If Cruise Control is left on, (CRUISE indicator light in the instrument cluster illuminated) Cruise Control can be switched on accidentally. Keep Cruise Control off (CRUISE indicator light OFF) when Cruise Control is not in use, to avoid inadvertently setting a speed.
- Use Cruise Control only when traveling on open highways in good weather.
- Do not use Cruise Control when it may not be safe to keep the car at a constant speed, for instance, driving in heavy or varying traffic, or on slippery (rainy, icy or snow-covered) or winding roads or over 6% uphill or down-hill roads.
- Pay particular attention to the driving conditions whenever using Cruise Control.

* NOTICE

During normal Cruise Control operation, when the SET switch is activated or reactivated after applying the brakes, Cruise Control will energize after approximately 3 seconds. This delay is normal.

* NOTICE

To activate Cruise Control, depress the brake pedal at least once after turning the ignition switch to the ON position or starting the engine.

⚠ WARNING

Misuse of Cruise Control

Do not use Cruise Control if the traffic situation does not allow you to drive safely at a constant speed and with sufficient distance to the vehicle in front.

Driving Assist button

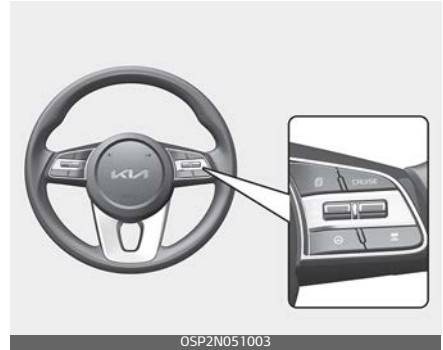

- CANCEL: Cancels Cruise Control operation.
- CRUISE: Turns Cruise Control on or off.
- RES+: Resumes or increases Cruise Control speed.
- SET-: Sets or decreases Cruise Control speed.

Setting Cruise Control speed

1. Press the Driving Assist button on the steering wheel, to turn the function on. The cruise status on the LCD screen will appear.

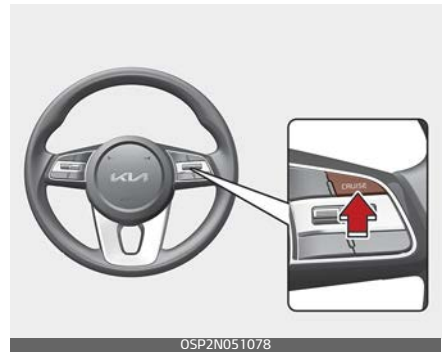

2. Accelerate to the desired speed, which must be more than 20 mph (30 km/h).
3. Move the switch down (to SET-), and release it at the desired speed. The cruise status on the LCD screen will appear. Release the accelerator pedal at the same time. The desired speed will automatically be maintained.
On a steep grade, the vehicle may slow down or speed up slightly while going downhill.

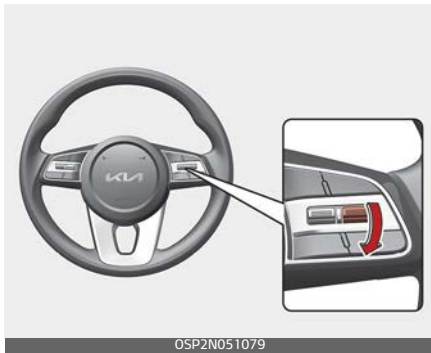

Increasing Cruise Control set speed

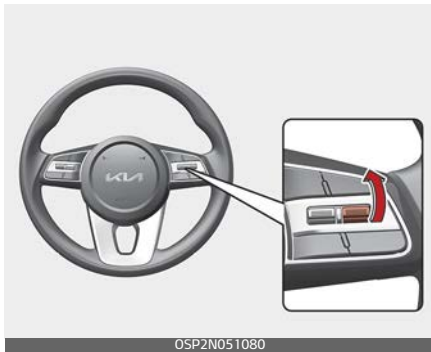

- Follow either of these procedures:
- Move the switch up (to RES+) and hold it. Your vehicle set speed will

- increase by 6.2 mph (10 km/h). Release the switch at the speed you want.
- Move the switch up (to RES+) and release it immediately. The cruising speed will increase by 1.2 mph (2.0 km/h) each time you move the switch up (to RES+) in this manner.

Accelerating temporarily with Cruise Control on

- If you want to speed up temporarily when Cruise Control is on, depress the accelerator pedal. Increased speed will not interfere with Cruise Control operation or change the set speed.
- To return to the set speed, take your foot off the accelerator pedal.

Canceling Cruise Control

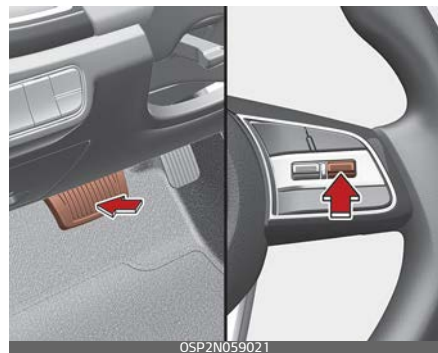

- Follow either of these procedures:
- Depress the brake pedal.
 - Push the CANCEL switch located on the steering wheel.

- Decrease the vehicle speed lower than the memory speed by 20 mph (30 km/h).
- Decrease the vehicle speed to less than approximately 20 mph (30 km/h).

Each of these actions will cancel Cruise Control operation (the cruise set speed will disappear), but it will not turn the function off. If you wish to resume Cruise Control operation, move up the switch (to RES+) located on your steering wheel. You will return to your previously preset speed.

Resuming cruising speed at more than approximately 20 mph (30 km/h)

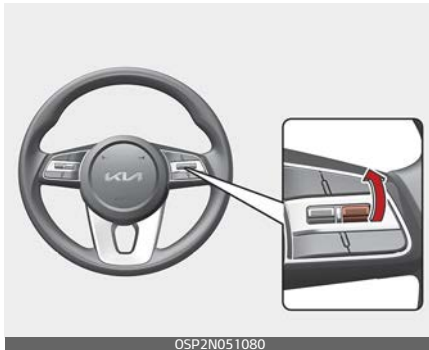

If any method other than the Driving Assist button was used to cancel cruising speed and the function is still activated, the most recent set speed will automatically resume when you move the switch up (to RES+).

It will not resume, however, if the vehicle speed has dropped below approximately 20 mph (30 km/h).

Turning Cruise Control off

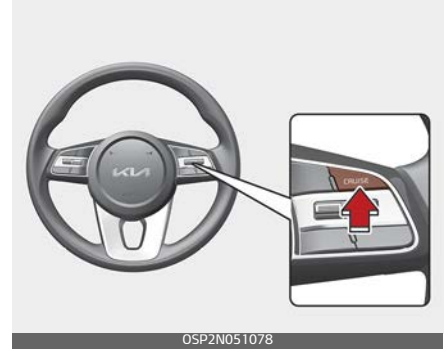

Follow either of these procedures:

- Press the Driving Assist button (The cruise status on the LCD screen will disappear).
- Turn the ignition off.

Both of these actions cancel Cruise Control operation. If you want to resume Cruise Control operation, repeat the steps provided in "Setting Cruise Control speed" on page 5-133.

Smart Cruise Control (SCC) (if equipped)

Smart Cruise Control is designed to allow you to program the vehicle to maintain a constant speed and a predetermined distance to the vehicle ahead without depressing the accelerator or brake pedal depending on road and traffic conditions.

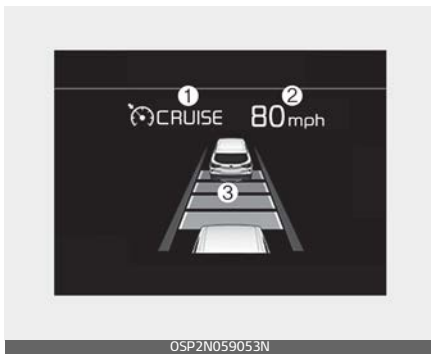

1. Cruise indicator
2. Set speed
3. Vehicle distance

To see Smart Cruise Control screen on the LCD display on the cluster, select Driving Assist mode (). For more details, refer to "LCD Display Modes" on page 4-59.

To see the Smart Cruise Control screen on the LCD display on the cluster, select Assist mode. For more information, refer to "LCD display" on page 4-58.

⚠ WARNING

For your safety, please read the owner's manual before using Smart Cruise Control.

⚠ WARNING

Smart Cruise Control Limitations

Smart Cruise Control is not a substitute for safe driving practices, but a convenience function only.

It is the responsibility of the driver to always check the speed and distance to the vehicle ahead.

⚠ WARNING

Take the following precautions:

- Always set the vehicle speed under the speed limit in your country.
- If Smart Cruise Control is left on, (cruise indicator in the instrument cluster illuminated) Smart Cruise Control can be activated unintentionally. Keep Smart Cruise Control off (cruise indicator off) when Smart Cruise Control is not in use, to avoid inadvertently setting a speed.
- Use Smart Cruise Control only when traveling on open highways in good weather.
- Do not use Smart Cruise Control when it may not be safe to keep

the car at a constant speed. For instance.

- When driving in heavy traffic or when traffic conditions make it difficult to drive at a constant speed.
 - When driving on rainy, icy, or snow-covered roads.
 - When driving on a steep downhill or uphill.
 - When driving in windy areas.
 - When driving in parking lots.
 - When driving near crash barriers.
 - When driving on a sharp curve.
 - When driving with limited view. (possibly due to bad weather, such as fog, snow, rain or sand-storm)
 - When the vehicle sensing ability decreases due to vehicle modification resulting level difference of the vehicle's front and rear.
- Unexpected situations may lead to possible accidents. Pay attention continuously to road conditions and driving even when Smart Cruise Control is being operated.
 - Pay particular attention to the driving conditions whenever using Smart Cruise Control.
 - Be careful when driving downhill using Smart Cruise Control.
 - Cruise function should not be used when the vehicle is being towed to prevent any damage.
- Always set the vehicle speed under the speed limit in your country.
 - Always pay continuous attention to road and driving conditions even when Smart Cruise Control is being operated.

Driving Assist Button

Driving Assist Button has the following functions.

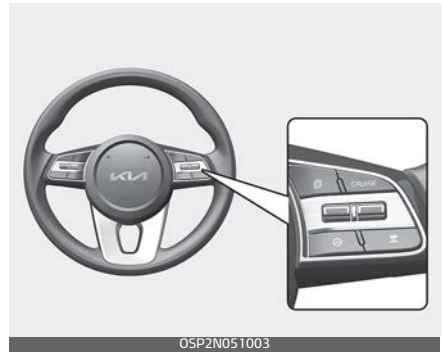

- CRUISE: Turns Smart Cruise Control on or off.
- RES+ : Resumes or increases cruise control speed.
- SET- : Sets or decreases cruise control speed.
-  : Sets vehicle distance.
- CANCEL: Cancels Cruise Control operation.

Smart Cruise Control speed

To set Smart Cruise Control speed

1. Push the Driving Assist button on the steering wheel to turn the function on. The cruise indicator will illuminate.

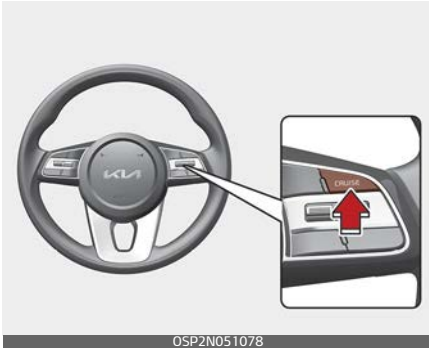

2. Accelerate to the desired speed. Smart Cruise Control speed can be set as follows:
 - 5 mph (10 km/h) ~ 110 mph (180 km/h): when there is no vehicle in front
 - 0 mph (0 km/h) ~ 110 mph (180 km/h): when there is a vehicle in front
3. Move the switch down (to SET-), and release it at the desired speed. The set speed and Vehicle Distance on the LCD screen will illuminate.
4. Release the accelerator pedal. The desired speed will automatically be maintained.

If there is a vehicle in front of you, the speed may decrease to maintain the distance to the vehicle ahead.

On a steep grade, the vehicle may slow down or speed up slightly while going uphill or downhill.

* NOTICE

Vehicle speed may decrease on an upward slope and increase on a downward slope.

⚠ CAUTION

- When vehicle speed is under 6 mph (10 km/h), Smart Cruise Control is canceled. The driver must adjust the vehicle speed by depressing the accelerator or brake pedal according to the road condition ahead and driving condition.
- The speed is set to 20 mph (30 km/h) when there is a preceding car in the front direction, and when it is set in the situation where the car is 0 ~20 mph (0~30 km/h).

To increase Smart Cruise Control set speed

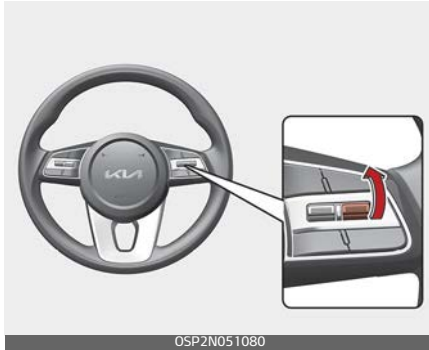

Follow either of these procedures:

- Push the switch up (RES+), and release it immediately. The cruising speed will increase by 1.0 mph (1.0 km/h) each time you move the switch up in this manner.
- Push the switch up (RES+), and hold it. Your vehicle set speed will increase by 5 mph (10 km/h). Release the switch at the speed you want.
- You can set the speed to 110 mph (180 km/h).

CAUTION

Check the traffic and driving conditions before using the switch. Driving speed may sharply increase, when you push up and hold the switch.

To decrease Smart Cruise Control set speed

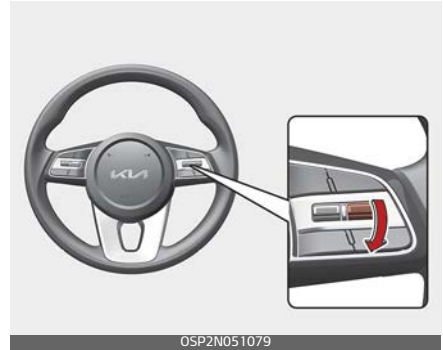

Follow either of these procedures:

- Push the switch down (SET-), and release it immediately. The cruising speed will decrease by 1.0 mph (1.0 km/h) each time you move the switch down in this manner.
- Push the switch down (SET-), and hold it. Your vehicle set speed will decrease by 5 mph (10 km/h). Release the switch at the speed you want.
- You can set the speed to 20 mph (30 km/h).

To temporarily accelerate with Smart Cruise Control on

If you want to speed up temporarily when Smart Cruise Control is on, depress the accelerator pedal. Increased speed will not interfere with Smart Cruise Control operation or change the set speed.

To return to the set speed, take your foot off the accelerator pedal.

If you push the switch down (SET-) at increased speed, the set speed is updated.

* NOTICE

Be careful when accelerating temporarily, because the speed is not controlled automatically at this time even if there is a vehicle in front of you.

Smart Cruise Control will be canceled when:

Canceled manually



Depressing the brake pedal.

Pushing the CANCEL switch located on the steering wheel.

Smart Cruise Control turns off temporarily when the Set Speed and Vehicle-to-Vehicle Distance indicator on the LCD display turns off.

The cruise indicator is illuminated continuously.

Canceled automatically

- The driver's door is opened.
- The shift lever is shifted to N (Neutral), R (Reverse) or P (Park).
- The parking brake is applied.
- The vehicle speed is over 110 mph (170 km/h).
- The ESC (Electronic Stability Control), TCS (Traction Control System) or ABS is operating.
- The ESC is turned off.
- The sensor or the cover is dirty or blocked with foreign matter.
- The vehicle is stopped for a certain period of time.
- The vehicle is stopped for more than 5 minutes.
- The vehicle stops and goes repeatedly for a long period of time.
- The accelerator pedal is continuously depressed for a long period of time.
- The accelerator pedal is continuously depressed for more than one minute.
- The engine performance is abnormal.
- Engine rpm is in the red zone.
- The driver starts driving by pushing the switch up (RES+)/down (SET-) or depressing the accelerator pedal, after the vehicle is

stopped by Smart Cruise Control with no other vehicle ahead.

- Forward Collision-Avoidance Assist is activated.
- The engine speed is in dangerous range.
- When the braking control is operated for FCA (Forward Collision-Avoidance Assist).
- The engine speed is in dangerous range.

Each of these actions will cancel Smart Cruise Control operation. The Set Speed and Vehicle-to-Vehicle Distance on the LCD display will go off.

In a condition Smart Cruise Control is canceled automatically, Smart Cruise Control will not resume even though the RES+ or SET- switch is pushed.

* NOTICE

If Smart Cruise Control is canceled in a situation not described above, take your vehicle to an authorized Kia dealer and have the function checked.

Smart Cruise Control canceled



If the function is canceled, the warning chime will sound and a message will appear for a few seconds.

You must adjust the vehicle speed by depressing the accelerator or brake pedal according to the road condition ahead and driving condition.

Always check the road conditions. Do not rely on the warning chime.

Resuming Smart Cruise Control set speed

If any method other than the cruise switch was used to cancel cruising speed and the function is still activated, the cruising speed will automatically resume when you push the switch up (RES+) or down (SET).

If you push the switch up (RES+), the speed will resume to the recently set speed. However, if vehicle speed drops below 5 mph (10

km/h), it will resume when there is a vehicle in front of your vehicle.

*** NOTICE**

Always check the road conditions when you push the switch up (RES+) to resume speed.

To turn Cruise Control off

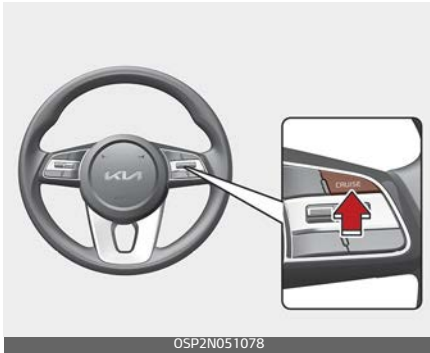

Pushing the Driving Assist button. The cruise indicator will go off.

If you wish not to use Cruise Control, always turn the function off by pushing the Driving Assist button.

To adjust the sensitivity of Smart Cruise Control

The sensitivity of vehicle speed when following the front vehicle to maintain the set distance can be adjusted. The rate of acceleration (sensitivity) along the front vehicle is set in conjunction with the 'DRIVE MODE' switch.

• **SCC responsiveness is not tied to the person**

- Normal: Vehicle speed following the front vehicle to maintain the set distance is normal.
 - Fast: Vehicle speed following the front vehicle to maintain the set distance is faster than normal speed.
- DRIVE MODE switch
Smart Cruise Control sensitivity changes when the 'DRIVE MODE' switch is operated.

Drive Mode	The sensitivity of Smart Cruise Control
NORMAL	Normal
COMFORT	Normal
SPORT	Fast

Setting vehicle distance

You can program the vehicle to maintain a predetermined distance to the vehicle ahead without depressing the accelerator pedal or brake pedal.

The Vehicle Distance will automatically activate when Smart Cruise Control is on.



OSP2N051081

- Select the appropriate distance according to road conditions and vehicle speed. Each time the button is pressed, the Vehicle Distance changes as follows:

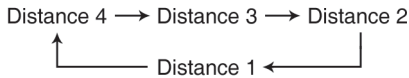

For example, if you drive at 56 mph (90 km/h), the distance maintain as follows;

- Distance 4 - approximately 172 ft (52.5 m)
- Distance 3 - approximately 131 ft (40 m)
- Distance 2 - approximately 107 ft (32.5 m)
- Distance 1 - approximately 82 ft (25 m)

*** NOTICE**

The distance is set to the last set distance when the function was previously used after having started the vehicle.

When the lane ahead is clear:



OSP2N059172

The vehicle speed will maintain the set speed.

When there is a vehicle ahead of you in your lane:

Distance 1

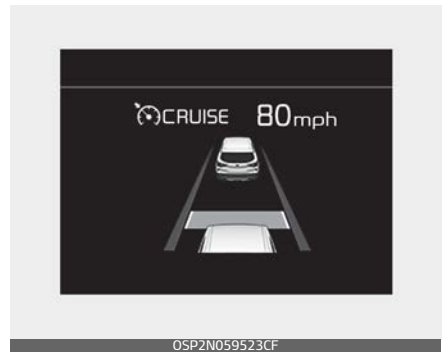

OSP2N059523CF

Distance 2

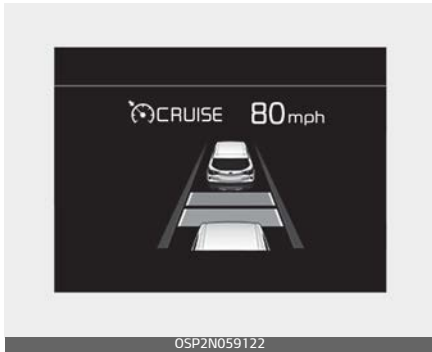

Distance 3



Distance 4



Your vehicle speed will slow down or speed up to maintain the selected distance. (A vehicle will appear in

front of your vehicle in the LCD display only when there is an actual vehicle in front of you.)

If the vehicle ahead speeds up, your vehicle will travel at a steady cruising speed after accelerating to the set speed.

⚠ WARNING

When using Smart Cruise Control:



- The warning message appears and warning chime sounds if the vehicle is unable to maintain a safe distance at the set cruise control speed.
- If the warning message appears and warning chime sounds, depress the brake pedal to actively adjust the vehicle speed and the distance to the vehicle ahead.
- Even if the warning message does not appear and warning chime does not sound, always pay attention to the driving conditions

to prevent dangerous situations from occurring.



If the vehicle ahead (vehicle speed: less than 20 mph (30 km/h) moves to the next lane, the warning chime will sound and a message will appear. Adjust your vehicle speed for vehicles or objects that can suddenly appear in front of you by depressing the brake pedal according to the road and driving conditions.

In traffic situation



Use switch or pedal to accelerate

- In traffic, your vehicle will stop if the vehicle ahead of you stops. Also, if the vehicle ahead of you starts moving, your vehicle will start as well. However, if the vehicle stops for more than 3 seconds, you must depress the accelerator pedal or push up the toggle switch (RES+) or push down the toggle switch (SET-) to start driving.
- If you push switch (RES+ or SET-) while Auto Hold and Smart Cruise Control is operating the Auto Hold will be released regardless of accelerator pedal operation and the vehicle will start to move. The AUTO HOLD indicator changes from green to white.

5

Radar to detect distance to the vehicle ahead



The sensor detects the distance to the vehicle ahead.

If the sensor is covered with dirt or other foreign matter, the Vehicle

Distance control may not operate correctly.

Always keep the area in front of the sensor clean.

Warning message

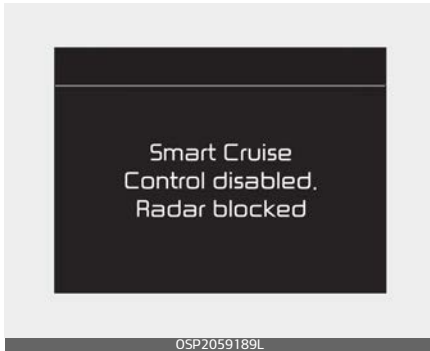

When the sensor lens cover is covered with dirt, snow, or debris, Smart Cruise Control operation may stop temporarily. If this occurs, a warning message will appear on the LCD display. Remove any dirt, snow, or debris and clean the radar sensor lens cover before operating Smart Cruise Control.

Smart Cruise Control may not properly activate, if the radar is totally covered, or if any vehicles are not detected after turning ON the vehicle (e.g. in an open terrain).

Smart Cruise Control malfunction message



The message will appear when the Vehicle Distance control function is not functioning normally.

In this case, take your vehicle to an authorized Kia dealer and have the function checked.

⚠ CAUTION

- Do not apply foreign objects such as a bumper sticker or a bumper guard near the radar sensor. Doing so may adversely affect the sensing performance of the radar.
- Always keep the radar sensor and lens cover clean and free of dirt and debris.
- Use only a soft cloth to wash the vehicle. Do not spray pressurized water directly on the sensor or sensor cover.
- Be careful not to apply unnecessary force on the radar sensor or sensor cover. If the sensor is forcibly moved out of proper align-

ment, Smart Cruise Control may not operate correctly. In this case, a warning message may not be displayed.

Have the vehicle inspected by an authorized Kia dealer.

- If the front bumper becomes damaged in the area around the radar sensor, Smart Cruise Control may not operate properly. If this occurs, take your vehicle to an authorized Kia dealer and have the function checked.
- Use only a genuine Kia sensor cover for your vehicle. Do not paint anything on the sensor cover.

Limitations of Smart Cruise Control

Smart Cruise Control may have limits to its ability to detect distance to the vehicle ahead due to road and traffic conditions.

Driving on a curve

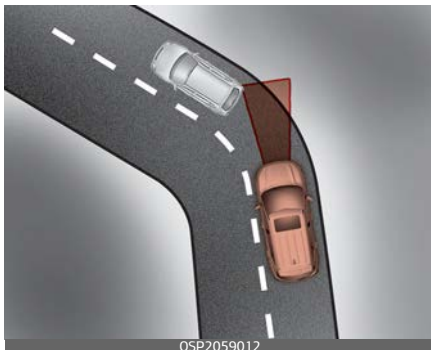

- Smart Cruise Control may not detect a moving vehicle in your lane, and then your vehicle could accelerate to the set speed. Also, the vehicle speed will decrease when the vehicle ahead is recognized suddenly.
- Select the appropriate set speed on curves and apply the brakes or accelerator pedal if necessary.

Your vehicle speed can be reduced due to a vehicle in the adjacent lane.



Apply the accelerator pedal and select the appropriate set speed. Check to be sure that the road conditions permit safe operation of Smart Cruise Control.

Driving on a slope



- During uphill or downhill driving, Smart Cruise Control may not detect a moving vehicle in your lane, and cause your vehicle to accelerate to the set speed. Also, the vehicle speed will rapidly decrease when the vehicle ahead is recognized suddenly.
- Select the appropriate set speed on inclines and apply the brake or accelerator pedal if necessary.

Changing lanes

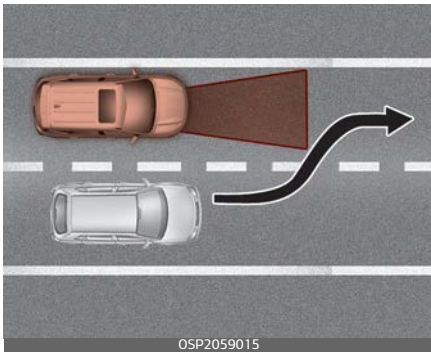

- A vehicle which moves into your lane from an adjacent lane cannot

be recognized by the sensor until it is in the sensor's detection range.

- The radar may not detect immediately when a vehicle cuts in suddenly. Always pay attention to the traffic, road and driving conditions.
- If a slower vehicle moves into your lane, your speed may decrease to maintain the distance to the vehicle ahead.
- If a faster vehicle which moves into your lane, your vehicle will accelerate to the set speed.

Recognizing the vehicle



Some vehicles in your lane cannot be recognized by the sensor:

- Narrow vehicles such as motorcycles or bicycles
- Vehicles offset to one side
- Slow-moving vehicles or sudden-decelerating vehicles
- Stopped vehicles
- Vehicles with small rear profile such as trailers with no loads

A vehicle ahead cannot be recognized correctly by the sensor if any of following occurs:

- When the vehicle is pointing upwards due to overloading in the luggage compartment.
- While the steering wheel is operating.
- When driving to one side of the lane.
- When driving on narrow lanes or on curves.

Apply the brake or accelerator pedal if necessary.



- Your vehicle may accelerate when a vehicle ahead of you disappears.
- When you are warned that the vehicle ahead of you is not detected, drive with caution.
- When driving in stop-and-go traffic, and a stopped vehicle in front of you merges out of the lane, the function may not immediately detect the new vehicle that is now in front of you. In this case, you must maintain a safe braking distance, and if necessary, depress

the brake pedal to reduce your driving speed in order to maintain a safe distance.

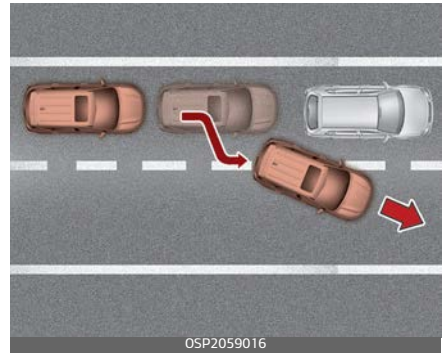

- Always look out for pedestrians when your vehicle is maintaining a distance with the vehicle ahead.



- Always be cautious for vehicles with higher height or vehicles carrying loads that sticks out from the back of the vehicle.

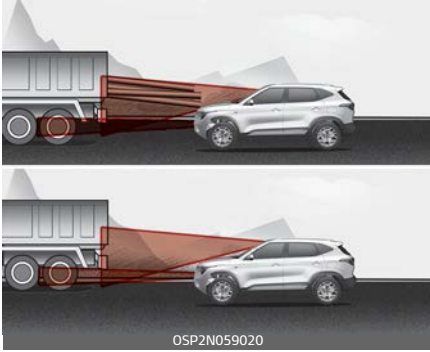

⚠ WARNING

When using Smart Cruise Control take the following precautions:

- If an emergency stop is necessary, you must apply the brakes. Smart Cruise Control may not be able to completely stop the vehicle or avoid a collision in every situation.
- Keep a safe distance according to road conditions and vehicle speed. If the Vehicle Distance is too close during a high-speed driving, a serious collision may result.
- Always maintain sufficient braking distance and decelerate your vehicle by applying the brakes if necessary.
- Smart Cruise Control cannot recognize a stopped vehicle, pedestrians or an oncoming vehicle. Always look ahead cautiously to prevent unexpected and sudden situations from occurring.
- Vehicles moving in front of you with a frequent lane change may cause a delay in the function's

reaction or may cause the function to react to a vehicle actually in an adjacent lane. Always drive cautiously to prevent unexpected and sudden situations from occurring.

- Always be aware of the selected speed and Vehicle Distance. The driver should not solely rely on the function but always pay attention to driving conditions and control your vehicle speed.
- Smart Cruise Control may not recognize complex driving situations so always pay attention to driving conditions and control your vehicle speed.
- For safe operation, carefully read and follow the instructions in this manual before use.
- Do not use Smart Cruise Control on steep inclines or when towing another vehicle or trailer since such extreme loading can interfere with your vehicle's ability to maintain the selected speed.
- Do not use Smart Cruise Control when the vehicle is towed.

*** NOTICE**

Smart Cruise Control may not operate temporarily due to:

- Electrical interference
- Modifying the suspension
- Differences of tire abrasion or tire pressure
- Installing different type of tires

This device complies with Part 15 of the FCC rules.

Operation is subject to the following three conditions:

1. This device may not cause harmful interference, and
2. This device must accept any interference received, including interference that may cause undesired operation.
3. Changes or modifications not expressly approved by the party responsible for compliance could void the user's authority to operate the device.

Radio frequency radiation exposure information:

This equipment complies with FCC radiation exposure limits set forth for an uncontrolled environment. This equipment should be installed and operated with minimum distance of 8 in (20 cm) between the radiator (antenna) and your body.

This transmitter must not be co-located or operating in conjunction with any other antenna or transmitter.

Navigation-based Smart Cruise Control (NSCC) (if equipped)

Navigation-based Smart Cruise Control is designed to assist drivers by receiving information from the Infotainment System about highway curves in advance from the Infotainment System when Smart Cruise Control is in operation and temporarily decelerating or limiting acceleration.

Navigation-based Smart Cruise Control setting

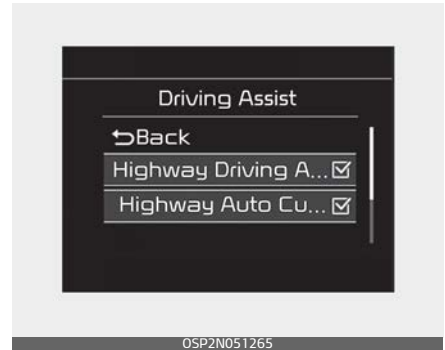

With the engine ON, Navigation-based Smart Cruise Control turns on and gets ready to be activated when you press SETUP button of the infotainment system and select 'Driver Assistance → Driving Assist → Highway Auto Curve Slowdown' in the infotainment system display. You can turn off the function by deselecting it. The set-up of Navigation-based Smart Cruise Control will be

maintained, as selected, when the engine is re-started.

Operating conditions

The function enters the ready status and the indicator light (AUTO) turns on when 'Highway Auto Curve Slowdown' is selected in the infotainment system display and the following conditions are met:

- Smart Cruise Control is on.
- The vehicle is driving on controlled access roads of certain highways.

Navigation-based Smart Cruise Control operation

- Navigation-based Smart Cruise Control operates only on controlled access roads of certain highways and does not work on curved sections at interchanges/junctions.
- When the function is activated, the vehicle decelerates automatically before reaching the curve according to its curvature, and the driving speed returns to the speed set by Smart Cruise Control after passing the curved section.
- The faster the vehicle speed, the earlier the deceleration starts.
- Navigation-based Smart Cruise Control basically operates based on the information about the curvature of roads in the driving path set by the Infotainment System. When the route is not set, it oper-

ates according to the curvature of roads that the vehicle is expected to enter.

Displaying the operating conditions

When Navigation-based Smart Cruise Control is activated, it is displayed in the cluster according to operating conditions:

Standby mode

If You activate NSCC in the infotainment system and the operating conditions are met, NSCC will be ready to operate and the indicator light (AUTO) will turn white in the cluster.



In operation

When the vehicle enters the curved section and the speed control function is activated, the indicator light (AUTO) turns green and illuminates until the vehicle is out of the curved section.



Drive carefully.

- When Navigation-based Smart Cruise Control cannot be activated, it is automatically deselected in the cluster and the indicator light (**AUTO**) turns off. However, if Highway Driving Assist is activated, the indicator light (**AUTO**) may turn on.
- Navigation-based Smart Cruise Control operates regardless of warnings/settings about road curves in the navigation function. So the start and end of Navigation-based Smart Cruise Control's operation may not match information provided by the Infotainment System.
- The function is not designed to work on national highways and public roads and available only on curved sections of controlled access roads of certain highways.
- Navigation-based Smart Cruise Control is automatically turned off at interchanges/junctions or on national highways or public roads.
- Navigation-based Smart Cruise Control will not operate when the vehicle moves away from main roads of the highways and enters curves sections at interchanges or junctions even though the roads may seem like part of the main roads.
- When the vehicle is not decelerated enough before entering the curve, 'Drive carefully' will be displayed in the instrument cluster.
- In all situations, the driver's behavior/judgment has the priority.
- Navigation-based Smart Cruise Control may not work, depending on the presence and driving status of the vehicle ahead.
- When the vehicle moves from the main roads of the highways and enters interchanges/junctions, national highways, or public roads, Navigation-based Smart Cruise Control will be automatically turned off.
- Navigation-based Smart Cruise Control may not function properly in the following situations:
 - The navigation is not working properly
 - The navigation is not updated to include the latest information about road curvature and changes.

- The real-time GPS or map information provided has differences with the actual road.
 - The navigation is overloaded by performing functions such as route search, video play-back, voice recognition, etc. simultaneously.
 - GPS signals are blocked in areas such as a tunnel.
 - The driver goes off the route, cancels the route to the set a new destination, or searches a route to the destination again.
 - The vehicle enters a service station or resting area.
 - Some road sections of the highway have been changed.
 - Android Auto, Car Play, or other navigation/smartphone-based technologies are in operation.
 - The navigation cannot detect the current vehicle position (ex: elevated roads including overpass adjacent to general roads or nearby roads exist in a parallel way).
 - The navigation is being updated while driving.
 - The navigation is being reset while driving.
 - The road is slippery due to bad weather such as rain or snow.
 - The road section is under construction.
 - The access to the road is limited according to some reasons.
- The curvature of the road is very sharp.
 - When the vehicle passes a tollgate on the main road of the highway, Navigation-based Smart Cruise Control decelerates based on the presumption that the vehicle is on the 1st lane. So, if the vehicle is not on the 1st lane, the deceleration speed may not be appropriate.
 - When the driver presses down the accelerator pedal while Navigation-based Smart Cruise Control decelerates vehicle, the vehicle may not be decelerated enough.
 - When the driver takes off his foot after pressing down the accelerator pedal for a while, the vehicle may be decelerated rapidly to drop the speed to safe levels.
 - The Infotainment System provides curvature that falls within the allowed speed range, so the vehicle may not decelerate if the driving speed is over the range.
 - Navigation-based Smart Cruise Control may not work properly when the road is narrow or its surface is uneven.
 - We do not recommend using Navigation-based Smart Cruise Control when the vehicle tows another vehicle or a trailer.
 - For your safety, please read the owner's manual before using the function.

- Navigation-based Smart Cruise Control reduces the driving speed based on the information about the curvature of the road provided by the Infotainment System and it may exceed the speed limit of the road. Navigation-based Smart Cruise Control is not a substitute for safe driving practices, but a supplementary function. It is the responsibility of the driver to comply with traffic laws and drive safely.
- Navigation-based Smart Cruise Control relies entirely on the road information provided by the Infotainment System, and Kia is not responsible for the driver's violation of traffic laws or accidents.

Lane Following Assist (LFA) (if equipped)

Lane Following Assist helps detect lane markers on the road with a front view camera at the front windshield, and assists the driver's steering to help keep the vehicle between lanes.

WARNING

- It is the driver's responsibility to operate the steering wheel for safe driving.
- Do not turn the steering wheel hastily if Lane Following Assist is activated.
- Lane Following Assist is designed to provide steering inputs so that the vehicle can stay in the center of the detected lane. Lane Following Assist does not automatically control the steering wheel at all times, which means the driver must have hands on the wheel at all times while driving.

- When using Lane Following Assist, always be aware of your surroundings and road conditions that may interrupt or stop Lane Following Assist.

⚠ CAUTION

- Do not attach glass tinting, stickers, accessories to the windshield near the front view camera near where the indoor mirror is placed.
- Inspection or modification may be required when replacing parts related to the windshield or front view camera. Have the function be inspected by an authorized Kia dealer.
- Depending on your surroundings and road conditions, Lane Following Assist could fail to recognize the lane and stop working. As such, extra caution is required while driving with Lane Following Assist on.
- Be sure to check the non-operating conditions and cautions for the driver before using Lane Following Assist.
- Do not place reflective materials, such as white paper or mirror, on the dashboard. Sunlight reflections can cause Lane Following Assist to not function properly.
- Loud audio volumes can prevent the occupants from hearing the alarm sounds from Lane Following Assist.

- Keeping your hands off the wheel while driving will trigger the hands-off warning and deactivate the steering-assist function.
- When driving at a high speed, the steering assist force can become weak and the vehicle can drive out of its lane, requiring extra caution. Comply with the speed limit.
- Attaching an object to the steering wheel could deter steering assistance.
- Attaching an object to the steering wheel could deter the hands-off alarming function.

Lane Following Assist operation

With the ENGINE START/STOP button in the ON or START position, Lane Following Assist can be activated by pressing the Lane Driving Assist button (🚗) on the steering wheel.

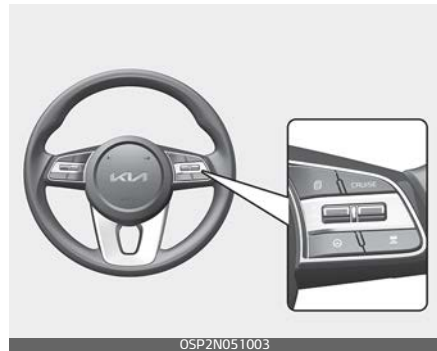

Operating conditions

When the function is activated, the indicator () on the cluster will illuminate. The color of the indicator will change depending on the condition of Lane Following Assist.

- Green: The function is in the enable state.
- White: The function is in the ready state.

Lane Following Assist activation

- After Lane Following Assist is activated, if the vehicle is within the lane and both lane markers are detected (lane color changes grey to white) and there is no abrupt steering by the driver, indicator light will change from white to green. This indicates that Lane Following Assist is in the ENABLED state and the steering wheel will be able to be controlled.
- The indicator light changes from green to white when the control is temporarily canceled.
- When the function does not recognize the lane or depending on the vehicle condition in front (presence of the vehicle, driving status, etc.). the steering wheel is controlled restrictively.

When the control of the steering wheel is stopped temporarily the activation indicator blinks in green and then changes to white.

Steering assist

If the vehicle is inside the lane with both lanes detected by Lane Following Assist, and there is no steep steering made by the driver, Lane Following Assist changes into steering assist mode.

The indicator light will come on green, and Lane Following Assist helps the vehicle stay in line by providing steering inputs.

When steering inputs are not being provided, the indicator light will flash green and changes to white.

Once Lane Following Assist recognizes the lanes, the color of the lane on the screen will change from gray to white.

⚠ WARNING

Lane Following Assist is designed to help the vehicle stay in its detected lane. It is a supplemental function only and is not a substitute for safe driving. Never rely solely on your Lane Following Assist.

Warning message



If you keep your hands off the wheel while driving with Lane Following Assist is in steering assist mode, the hands-off warning will be triggered.



If the driver keeps hands off the wheel even with the hands-off warning on, the steering assist is temporarily deactivated automatically.

If you activate Smart Cruise Control with Lane Following Assist released, the steering assist will re-start.

CAUTION

- Hands-off warnings may be delayed depending on road conditions. Always keep your hands on the steering wheel while driving.
- Hold the steering wheel tight. Otherwise, Lane Following Assist could misjudge that the driver's hands are off the wheel, and a hands-off warning may occur.

Lane Following Assist malfunction

This warning message means there is a problem with Lane Following Assist.



In this case, have the function checked by an authorized Kia dealer.

CAUTION

- It is the driver's responsibility to operate the steering wheel while driving.
- With Lane Following Assist on, the driver can still steer the vehicle by operating the wheel on his own.

- We recommend that the driver turn off Lane Following Assist and operate the steering wheel by himself in the following situations:
 - bad weather
 - bad road conditions
 - when frequent operation of the steering wheel is required
 - When towing other vehicle or trailers
- The steering wheel can feel heavy or light if Lane Following Assist is assisting the steering.

Limitations of Lane Following Assist

Lane Following Assist has the following limitations, so always pay attention to your driving and do not rely solely on Lane Following Assist.

- If the driver turns on the turn signal light or the emergency warning light to change the lane
 - Operate the turn signal light switch before changing the lane
 - If you change the lane without operating the turn signal lights, steering reaction force of the wheel may occur.
- Once Lane Following Assist is turned on or the lane is changed, the vehicle should be in the center of the road to switch to the steering assist mode. If the driver keeps driving along the lane, Lane Following Assist will not assist the steering.

- Electronic Stability Control (ESC) or Vehicle Stability Management (VSM) is activated.
- When driving on a curved road at a high speed, steering assist mode may not work.
- When sudden steering is made, Lane Following Assist could be temporarily deactivated.
- If you change the lane in a hurry, Lane Following Assist does not assist the steering.
- If the vehicle suddenly stops, Lane Following Assist does not assist the steering.
- If the lane is too narrow or too wide, steering is not assisted.
- If either of the lanes is not recognized, the steering is not assisted
- If the radius is too small for the curve

Caution for the driver

If lane recognition is difficult or limited for Lane Following Assist as shown below, the driver may need to be more careful because the function may not operate or may cause unnecessary operation.

Roads or lane markings in bad condition

- When the lane is tainted or invisible.
- When the driver cannot see the lane due to rain, snow, dust, sand, oil, puddles, etc.

- When roads are set or the colors of the lane and road are not distinctive.
- If there is a sign other than the lane near the lane or a mark similar to the lane.
- When the lane is not clear or damaged.
- If the road is covered in the shadows of objects around the road, such as medians, guard rails, noise walls, and trees.
- If the number of lanes increases or decreases, or if the lanes intersect with each other more intensely. (tollgate entry section, road section / joining section, etc.)
- When there are two or more lane markings such as a construction section, a designated lane, etc.
- When the lane is crowded such as the construction section or the lane is replaced by some structures.
- If there is a road marking such as a zigzag lane, crosswalk mark, or road surface milestone.
- When a lane suddenly becomes invisible or disappears from an intersection.
- If the vehicle's headlights are not used at night or in the tunnel, or the brightness of the headlights is too weak.
- If there are boundary structures such as tollgate booths and sidewalk blocks.
- If it is difficult to distinguish lanes due to the reflection on the wet road made by sunlight, street-light, and oncoming traffic.
- When the backlight is strongly reflected in the direction of the vehicle.
- When Driving to the left or right lane by bus lane or on the bus lane.
- If there is not enough distance between the front car or if the lane is covered by the car ahead of me.
- If the vehicle moves beyond the marked lanes while changing lanes on a curve road, such as a steep curve or a continuous curve.
- When passing through speed bump or there is sudden movement in any direction.
- If the vehicle is severely shaken.
- When the temperature around the rearview mirror is very high due to direct sunlight.

External environmental conditions affecting Lane Following Assist

- If the outside brightness of the vehicle suddenly changes, such as when entering or exiting the tunnel or passing under the bridge.

When the front view camera has poor visibility

- If the windshield of the vehicle and the camera lens are covered with dust, fingerprints, or tinting.

- If the camera has poor visibility due to bad weather such as fog, heavy rain, heavy snow.
- If moisture is not completely removed from the windscreen.
- When placing objects on the dashboard, etc.

Highway Driving Assist (HDA) (if equipped)

Highway Driving Assist is designed to control the vehicle distance and speed when driving on the highway. The function assists drivers by receiving information about speed limit of the highway that the vehicle is on and automatically changing the set speed of Smart Cruise Control when it is needed.

WARNING

- Highway Driving Assist is not a substitute for safe driving practices, but a convenience function. It is the responsibility of the driver to always be aware of the surroundings and drive safely.
- Highway Driving Assist relies entirely on the road information provided by the Infotainment System. It is the responsibility of the driver to follow traffic laws and avoid accidents.
- For your safety, please read the owner's manual before using the function.

Detecting sensor

Front view camera



OSP2N051011

Front radar



OSP2N051012

Refer to the picture above for the detailed location of the detecting sensors.

CAUTION

For more details on the precautions of the detecting sensors, refer to "Detecting sensor" on page 5-90.

* NOTICE

- Highway Driving Assist is available only on controlled access road of certain highways.
 - * Controlled access road indicates roads with limited entrances and exits that allow uninterrupted high speed traffic flow. Only passenger cars, truck and motorcycles are allowed on controlled access roads.

Available highway

USA, CANADA	Controlled access road
-------------	------------------------

- Additional highways may be expanded by future navigation updates.

Highway Driving Assist Setting and activation

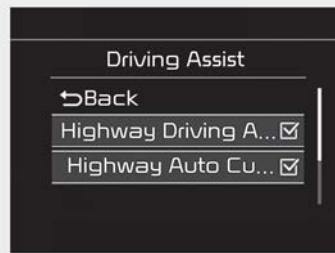

OSP2N051265

1. With the engine on, press the MODE button (⏏) several times on the steering wheel until 'User Settings' menu appears on the LCD.

2. Select 'Driver Assistance → Driving Assist → Highway Driving Assist' with the MOVE switch (∧ / ∨) and the OK button on the steering wheel. HDA will be ready to be used.

If your vehicle is equipped with an infotainment system, you can learn how to setup on the website via QR code in the infotainment quick reference guide.

The set-up of Highway Driving Assist will be maintained, as selected, when the engine is re-started.

Operating conditions

If you activate Highway Driving Assist in the instrument cluster and the following conditions are met, Highway Driving Assist will be ready to operate, and the indicator light  **HDA** will come on green in the cluster.

- When driving on the highway main line.
- When Smart Cruise Control is in operation (Vehicle deceleration and acceleration control)
 - Refer to "Smart Cruise Control (SCC) (if equipped)" on page 5-136.
 - If Smart Cruise Control is in standby mode (Smart Cruise Control is on but speed is not set), Highway Driving Assist will be in the same mode. The white

indicator  **HDA** light will be turned on.

- When the vehicle speed is below 95 mph (153 km/h)

Highway Driving Assist operation

The speed is automatically set in accordance with the steering control and the highway speed limit when all the operating conditions are met.

Steering control

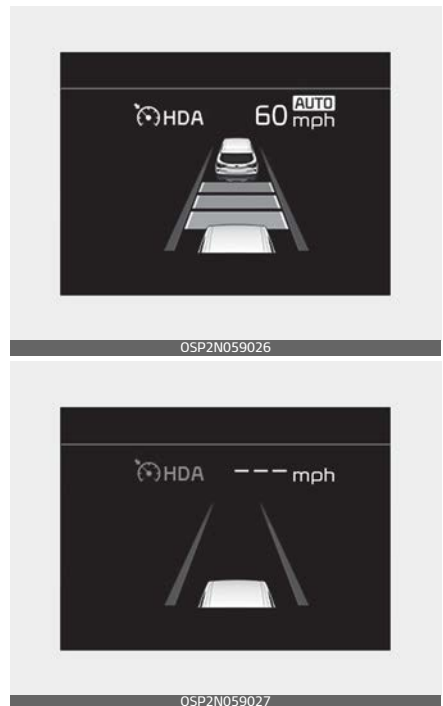

If both lanes are recognized properly (lane color: white), the steering

wheel indicator (🚗) lights up in green and then the steering control is initiated. When the function cannot provide temporary steering inputs, the indicator flashes green and then changes to white. Even when Highway Driving Assist cannot provide temporary steering inputs, it still controls the distance from other vehicles. (For information on non-operating conditions of steering wheel control, please refer to "Limitations of Lane Following Assist" on page 5-159.)

Warning related to steering wheel



The hands-off warning appears when the function detects that the driver's hands are not on the steering wheel while Highway Driving Assist is in work. (First warning: warning message, Second warning: warning message with warning sound)

⚠ CAUTION

- The hands-off warning may be delayed depending on road conditions. Always keep your hands on the steering wheel while driving.
- If you hold the steering wheel lightly, it may be perceived that the steering wheel is not held at all and trigger the hands-off warning.

When the hands-off warning lasts for a certain period of time



If you keep your hands off the steering wheel even with the hands-off warning on, the steering assist and Smart Cruise Control will be temporarily released automatically.

If you activate Smart Cruise Control with Highway Driving Assist released, the steering assist will restart.

Automatic speed setting

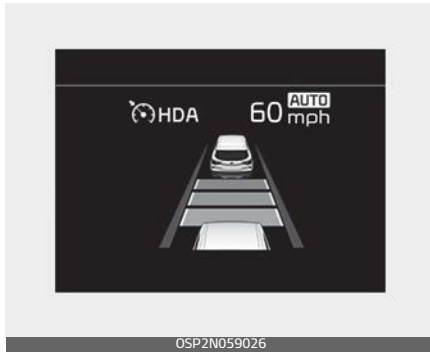

In the automatic speed setting mode, the set speed is automatically adjusted to the changing speed limits of highway sections.



If the driver directly changes the speed, it enters the manual speed setting mode and the set speed is displayed in white and the "AUTO" symbol will disappear.

HDA malfunction

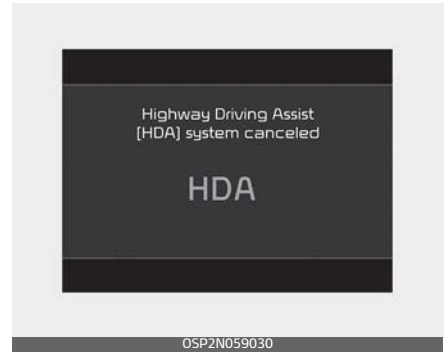

This message shows that there is a problem with Highway Driving Assist, so have your vehicle inspected by an authorized Kia dealer.

⚠ CAUTION

- In all situations, the driver's behavior/judgment has the priority.
- Highway Driving Assist operates only when the driver has set it through the user settings in the instrument cluster.

If your vehicle is equipped with an infotainment system, you can learn how to setup on the website via QR code in the infotainment quick reference guide.

- Highway Driving Assist is limited in other countries.
- Highway Driving Assist only operates based on the speed limits of the highway but it does not work with the speed cameras.

- The time gap could occur between the navigation speed warning and function operation.
- If the speed limits of speed cameras exceed the highway speed limits during the automatic speed setting mode, the navigation displays its own warning.
- The function is not designed to work on expressways, national highways and public roads. The function automatically cancels when you leave the highway.
- Highway Driving Assist is deactivated on the user settings in the instrument cluster when it is not in operable condition.
- When the vehicle is at resting area or interchanges or junctions away from the main line of the highway, Highway Driving Assist is automatically turned off so it requires caution to the driver.
- When you are 0.3 mile (500 m) before/after an open-type toll gate while driving on the highway, Highway Driving Assist is automatically turned off so it requires caution to the driver. It automatically switches to Smart Cruise Control and a pop-up window will appear to inform you of the change.
- When the automatic speed setting is in operation, the set speed may automatically change on the highway in accordance with changes in speed limit, leading to

automatic acceleration/deceleration of the vehicle.

WARNING

- Regardless of whether Highway Driving Assist is on or off, you must keep eyes on the road while driving and must obey all traffic laws.
- Highway Driving Assist depends entirely on road information provided by the Infotainment System, and the car manufacturer is not responsible for the driver's violation of road traffic laws or accidents.

WARNING

Highway Driving Assist may not function properly in the following situations:

- The navigation is not working properly.
- The navigation is not updated.
- The real-time GPS or map information provided has errors.
- The navigation is overloaded by performing functions, such as route search, video play-back, voice recognition, etc, that are performing simultaneously.
- GPS signals are blocked in areas such as a tunnel.
- The driver goes off course or the route to the destination is

- changed or canceled by resetting the navigation.
- The vehicle enters a service station or resting area.
 - Android Auto or Car Play is operating.
 - The navigation cannot detect the current vehicle position (ex: elevated roads including overpass adjacent to general roads or nearby roads exist in a parallel way).
 - The navigation is being updated while driving.
 - The navigation is being reset while driving.
 - The road is slippery due to bad weather such as rain or snow.

* Refer to "Smart Cruise Control (SCC) (if equipped)" on page 5-136 for cautions and warnings about Vehicle Distance control and front radar.

* Refer to "Lane Keeping Assist (LKA) (if equipped)" on page 5-105 for cautions and warnings about steering control and front view camera.

This device complies with Part 15 of the FCC rules.

Operation is subject to the following three conditions:

1. This device may not cause harmful interference, and

2. This device must accept any interference received, including interference that may cause undesired operation.
3. Changes or modifications not expressly approved by the party responsible for compliance could void the user's authority to operate the device.

Radio frequency radiation exposure information:

This equipment complies with FCC radiation exposure limits set forth for an uncontrolled environment. This equipment should be installed and operated with minimum distance of 8 in (20 cm) between the radiator (antenna) and your body.

This transmitter must not be co-located or operating in conjunction with any other antenna or transmitter.

Rear Cross-Traffic Collision-Avoidance Assist (RCCA) (if equipped)

Rear Cross-Traffic Collision-Avoidance Assist description

Rear Cross-Traffic Collision Warning

Rear Cross-Traffic Collision Warning uses radar sensors to monitor the approaching cross traffic from the left and right side of the vehicle when your vehicle is in reverse.



The blind spot detection range varies relative to the approaching vehicle speed.

Rear Cross-Traffic Collision-Avoidance Assist

Rear Cross-Traffic Collision-Avoidance Assist monitors approaching cross traffic from the left and right side of the vehicle when your vehicle is approaching.

Rear Cross-Traffic Collision-Avoidance Assist may activate the Electronic Stability Control (ESC) in accordance with a colliding possibility with an approaching vehicle. It is to lower the colliding risk or mitigate the colliding damage.

⚠ WARNING

- Always be aware of road conditions while driving and be alert for unexpected situations even though Rear Cross-Traffic Collision-Avoidance Assist is operating.
- Rear Cross-Traffic Collision-Avoidance Assist is supplemental functions to assist you. Do not rely entirely on the functions. Always pay attention, while driving, for your safety.
- Rear Cross-Traffic Collision-Avoidance Assist is not substitutes for proper and safe driving. Always drive safely and use caution when backing up the vehicle.

Detecting sensor

Front view camera



Front radar



Refer to the picture above for the detailed location of the detecting sensors.

CAUTION

For more details on the precautions of the detecting sensors, refer to "Detecting sensor" on page 5-90.

Rear Cross-Traffic Collision setting and activation

Rear Cross-Traffic Collision setting



- The driver can activate the functions by placing the ignition switch to the ON position and by selecting "User Settings → Driver Assistance → Parking Safety → Rear Cross-Traffic Safety". RCCA turns on and get ready to be activated when 'Rear Cross-Traffic safety' is selected.

If your vehicle is equipped with an infotainment system, you can learn how to setup on the website via QR code in the infotainment quick reference guide.

- When the engine is turned off then on again, the functions are always ready to be activated.
- When the function is initially turned on and when the engine is turned off then on again, the warning light will illuminate for 3 seconds on the outside rear view mirror.

Warning Timing



The driver can select the initial warning activation time in the User Settings in the LCD display or infotainment system display by selecting 'User Settings → Driver Assistance → Warning Timing'.

The options for the initial Rear Cross-Traffic Collision Warning includes the following:

- Normal: When this condition is selected, the initial Rear Cross-Traffic Collision Warning is activated normally. If this setting feels sensitive, change the option to 'Late'.
- The warning activation time may feel late if the a vehicle at the side or rear abruptly accelerates.
- Late: Select this warning activation time when the traffic is light and you are driving in a low speed.

⚠ CAUTION

If you change the warning timing, the warning time of other functions

may change. Always be aware before changing the warning timing.

Warning Volume

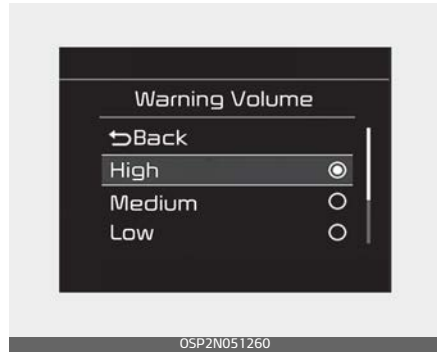

The driver can select the warning volume of Rear Cross-Traffic Collision Warning by selecting 'User Settings → Driver Assistance → Warning Volume → High/Medium/Low'.

* NOTICE

If you change the warning volume, the warning volume of other functions may change. Always be aware before changing the warning volume.

Operating conditions

To operate:



Go to the "User Settings → Driver Assistance → Parking Safety → Rear Cross-Traffic Safety" on the LCD display or infotainment system display. The function will turn on and standby to activate.

The function will activate when vehicle speed is below 7 mph (10 km/h) and with the shift button in R (Reverse).

* The function will not activate when the vehicle speed exceeds 7 mph (10 km/h). The function will activate again when the speed is below 5 mph (8 km/h).

The function's detecting range is approximately 1~65 ft (0.5~20 m). An approaching vehicle will be detected if their vehicle speed is within 5~22.5 mph (8~36 km/h).

Note that the detecting range and operating speed may vary under certain conditions. As always, use

caution and pay close attention to your surroundings when backing up your vehicle.

Warning and function control

Rear Cross-Traffic Collision Warning



[A]: Warning sound



Driving your vehicle

Right



[A]: Warning sound

Right



If the vehicle detected by the sensors approaches from the rear left/right side of your vehicle, the warning chime will sound, the warning light on the outside rear view mirror will blink and a message will appear on the LCD display. If the rear view monitor is in activation, a message will also appear on the infotainment system screen.

The warning will stop when:

- The detected vehicle moves out of the sensing area or

Rear Cross-Traffic Collision-Avoidance Assist (RCCA)

- when the vehicle is right behind your vehicle or
- when the vehicle is not approaching your vehicle or
- when the other vehicle slows down or
- The vehicle's approaching speed is decreased.

Rear Cross-Traffic Collision-Avoidance Assist

Left

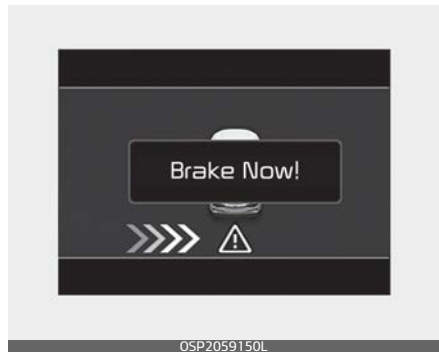

Left



Right



Right



If the risk of collision is detected while Rear Cross-Traffic Collision-Avoidance Assist is generated, brake is controlled. The instrument cluster will inform the driver of the brake control. If the rear view monitor is in activation, a message will also appear on the infotainment system screen.

After the brake control, the driver must immediately depress the brake pedal and check the surroundings.

- The brake activation by the function lasts for about 2 seconds. The driver must pay attention as the brake is disengaged after 2 seconds.
- The brake control by the function is canceled if the driver depresses the brake pedal with sufficient power.
- Brake control is activated once for each right/left approach after shifting the shift button to R (Reverse).

The brake control may not operate properly according to the status of the ESC (Electronic Stability Control). The same warning message is displayed on the instrument cluster for this case also.

- When the ESC (Electronic Stability Control) warning light is on.
- When the ESC (Electronic Stability Control) is engaged in a different function.

⚠ CAUTION

- When the operation condition of the Rear Cross-Traffic Collision-Avoidance Assist is met, the warning will occur every time a vehicle approaches the side or rear of your stopped (0 mph (0 km/h) vehicle speed) vehicle.
 - The function's warning or brake may not operate properly if the left or right of your vehicle's rear bumper is blocked by a vehicle or obstacle.
 - The driver should always use extreme caution while operating the vehicle, whether or not the warning light on the outer side view mirror illuminates or there is a warning alarm.
 - Playing the vehicle audio system at high volume may prevent occupants from hearing the function's warning sounds.
 - If any other warning sound such as seat belt warning chime is already generated, the Rear Cross-Traffic Collision-Avoidance Assist warning may not sound.
-

⚠ WARNING

- Drive safely even though the vehicle is equipped with a Rear Cross-Traffic Collision-Avoidance Assist. Do not rely solely on the function but check your surrounding when backing up the vehicle.
 - The driver is responsible for accurate brake control.
 - Always use extreme caution while driving. Rear Cross-Traffic Collision-Avoidance Assist may not operate properly or unnecessarily operate in accordance with your driving situations.
 - Rear Cross-Traffic Collision-Avoidance Assist is not a substitute for safe driving practices, but a convenience function only. It is the responsibility of the driver to always drive cautiously to prevent unexpected and sudden situations from occurring. Pay attention to the road conditions and surroundings at all times.
-

Detecting sensors



The rear corner radars are the sensors inside the rear bumper for detecting the side and rear areas. Always keep the rear bumper clean for proper operation of the function.

⚠ CAUTION

- The function may not work properly when the bumper has been damaged, or if the rear bumper has been replaced or repaired.
- The function may turn off if interfered by electromagnetic waves.
- Always keep the sensors clean.
- NEVER disassemble the sensor component or apply any impact on the sensor component.
- Be careful not to apply unnecessary force on the radar sensor or sensor cover. If the sensor is forcibly moved out of proper alignment, the function may not operate correctly. In this case, a warning message may not be dis-

played. Have the vehicle inspected by an authorized Kia dealer.

- Do not apply foreign objects such as a bumper sticker or a bumper guard near the radar sensor or apply paint to the sensor area. Doing so may adversely affect the performance of the sensor.

Warning message

Blind-Spot Collision Warning (BCW) system disabled. Radar blocked



This warning message may appear when:

- One or both of the sensors on the rear bumper is blocked by dirt or snow or a foreign object.
- A trailer or carrier is installed.
- Driving in rural areas where the sensor does not detect another vehicle for an extended period of time.
- When there is inclement weather such as heavy snow or rain.

If any of these conditions occur, the function will turn off automatically.

When Blind-Spot Collision Warning canceled warning message is displayed in the cluster, check to make sure that the rear bumper is free from any dirt or snow in the areas where the sensor is located.

Remove any dirt, snow, or foreign material that could interfere with the radar sensors.

After any dirt or debris is removed, the function should operate normally after about 10 minutes of driving the vehicle.

If the function still does not operate normally, have your vehicle inspected by an authorized Kia dealer.

*** NOTICE**

Turn off Blind-Spot Collision-Avoidance Assist and Rear Cross-Traffic Collision-Avoidance Assist when a trailer or carrier is installed.

- Deactivate Blind-Spot Collision-Avoidance Assist by selecting "User Settings → Driver Assistance → Blind-Spot Safety → Off" in the cluster or infotainment system.
- Deactivate Rear Cross-Traffic Collision-Avoidance Assist by deselecting "User settings → Driver Assistance → Parking Safety → Rear Cross Traffic

Safety" in the cluster or infotainment system.

If your vehicle is equipped with an infotainment system, you can learn how to setup on the website via QR code in the infotainment quick reference guide.

Check Blind-Spot Collision Warning system

Type A



Type B



If there is a problem with Blind-Spot Collision Warning, a warning message will appear. The function will turn off automatically. Rear Cross-

Traffic Collision-Avoidance Assist will not operate also if Blind-Spot Collision Warning turns off due to malfunction. You should have the vehicle inspected by an authorized Kia dealer.

Limitations of Rear Cross-Traffic Collision

The driver must be cautious in the below situations, because the function may not detect other vehicles or objects in certain circumstances.

- When a trailer or carrier is installed.
- The vehicle drives in inclement weather such as heavy rain or snow.
- The radar sensor is polluted with rain, snow, mud, etc.
- The rear bumper is damaged, or the sensor is out of the original default position.
- The vehicle height gets lower or higher due to heavy loading in a liftgate, abnormal tire pressure, etc.
- When the temperature of the rear bumper is high.
- When the sensors are blocked by other vehicles, walls or parking-lot pillars.
- The vehicle drives on a curved road.
- The road pavement (or the peripheral ground) abnormally contains metallic components (i.e.

possibly due to subway construction).

- There is a fixed object near the vehicle, such as a guardrail.
- While going down or up a steep road where the height of the lane is different.
- Driving on a narrow road where trees or grass or overgrown.
- Driving in rural areas where the sensor does not detect another vehicle for an extended period of time.
- Driving on a wet road.
- Driving on a road where the guardrail or wall is in double structure.
- A big vehicle is near such as a bus or truck.
- When the other vehicle approaches or passes very close.
- When the other vehicle passes at a very fast speed.
- While changing lanes.
- If the vehicle has started at the same time as the vehicle next to you and has accelerated.
- When the vehicle in the next lane moves two lanes away from you or when the vehicle two lanes away moves to the next lane from you.
- A motorcycle or bicycle is near.
- A flat trailer is near.
- If there are small objects in the detecting area such as a shopping cart or a baby stroller.

- If there is a low height vehicle such as a sports car.
- The brake pedal is depressed.
- ESC (Electronic Stability Control) is activated.
- ESC (Electronic Stability Control) malfunctions.
- The tire pressure is low or a tire is damaged.
- The brake is reworked.
- The vehicle sharply stops.
- Temperature is extremely low around the vehicle.
- The vehicle drives on a slippery surface due to snow, water puddle, or ice.
- If the vehicle moves backward after the vehicle is parked with a diagonal line

Driving where there is a vehicle or structure near

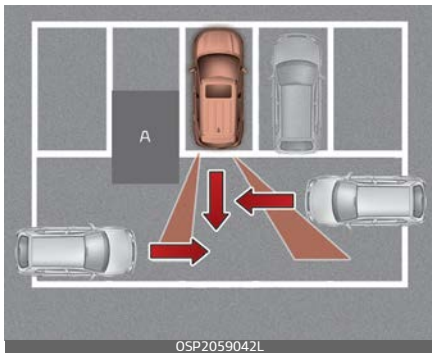

[A] : Structure

The function may not operate properly when driving where there is a vehicle or structure near.

In certain instances, the function may not detect the vehicle approaching from behind and the warning or brake may not operate properly.

Always pay attention to your surroundings while driving.

When the vehicle is in a complex parking environment



Rear Cross-Traffic Collision-Avoidance Assist may not operate properly when the vehicle is in a complex parking environment.

In certain instances, Rear Cross-Traffic Collision-Avoidance Assist may not be able to exactly determine the risk of collision for the vehicles which are parking or pulling out near your vehicle (e.g., a vehicle escaping beside your vehicle, a vehicle parking or pulling out in the rear area, a vehicle approaching your vehicle making a turn, etc.).

If this occurs, the warning or brake may not operate properly.

When the vehicle is parked diagonally

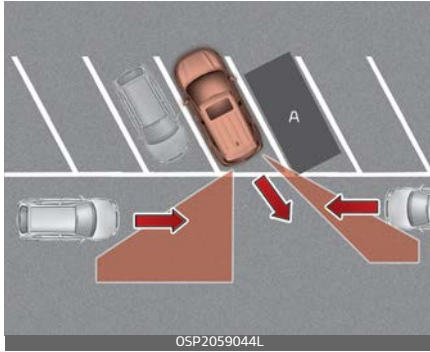

[A]: Vehicle

Rear Cross-Traffic Collision-Avoidance Assist may not operate properly when the vehicle is parked diagonally.

In certain instances, when the diagonally parked vehicle is pulled out of the parking space, Rear Cross-Traffic Collision-Avoidance Assist may not detect the vehicle approaching from the rear left/right of your vehicle. In this case, the warning or brake may not operate properly.

Always pay attention to your surroundings while backing up.

When the vehicle is on/near a slope

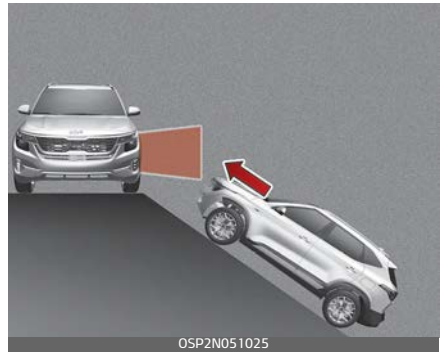

Rear Cross-Traffic Collision-Avoidance Assist may not operate properly when the vehicle is on/near a slope.

In certain instances, Rear Cross-Traffic Collision-Avoidance Assist may not detect the vehicle approaching from the rear left/right and the warning or brake may not operate properly.

Always pay attention to your surroundings while backing up.

Pulling into the parking space where there is a structure

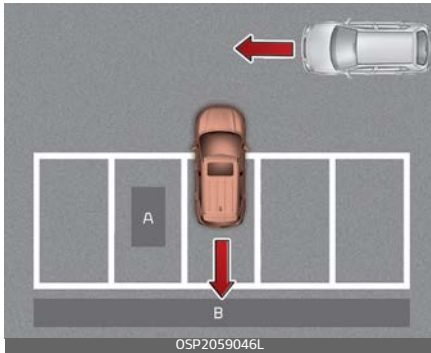

[A]: Structure, [B]: Wall

The function may not operate properly when pulling in the vehicle to the parking space where there is a structure at the back or side of your vehicle.

In certain instances, when backing into the parking space, the function may not detect the vehicle moving in front of your vehicle. In this case, the warning or brake may not operate properly.

Always pay attention to your surroundings while driving.

When the vehicle is parked rearward



If the vehicle is parked rearward and the radar sensor detects the another vehicle in the rear area of the parking space, the function can warn or control braking. Always pay attention to your surroundings while driving.

This device complies with Part 15 of the FCC rules.

Operation is subject to the following two conditions:

1. This device may not cause harmful interference, and
2. This device must accept any interference received, including interference that may cause undesired operation.

Economical operation

Your vehicle's fuel economy depends mainly on your style of driving, where you drive and when you drive.

Each of these factors affects how many miles (kilometers) you can get from a gallon (liter) of fuel. To operate your vehicle as economically as possible, use the following driving suggestions to help save money in both fuel and repairs:

- Drive smoothly. Accelerate at a moderate rate. Don't make "jack-rabbit" starts or full-throttle shifts and maintain a steady cruising speed. Don't race between stoplights. Try to adjust your speed to the traffic so you don't have to change speeds unnecessarily. Avoid heavy traffic whenever possible. Always maintain a safe distance from other vehicles so you can avoid unnecessary braking. This also reduces brake wear.
 - Drive at a moderate speed. The faster you drive, the more fuel your vehicle uses. Driving at a moderate speed, especially on the highway, is one of the most effective ways to reduce fuel consumption.
 - Take care of your tires. Keep them inflated to the recommended pressure. Incorrect inflation, either too much or too little, results in unnecessary tire wear.
- Check the tire pressures at least once a month.
- Be sure that the wheels are aligned correctly. Improper alignment can result from hitting curbs or driving too fast over irregular surfaces. Poor alignment causes faster tire wear and may also result in other problems as well as greater fuel consumption.
 - Keep your car in good condition. For better fuel economy and reduced maintenance costs, maintain your car in accordance with the maintenance schedule in "Scheduled maintenance service" on page 7-10. If you drive your car in severe conditions, more frequent maintenance is required (Refer to "Maintenance Under Severe Usage Conditions - Non Turbo Models" on page 7-14 for details).
 - Travel lightly. Don't carry unnecessary weight in your car. Weight reduces fuel economy.
 - Don't let the engine idle longer than necessary. If you are waiting (and not in traffic), turn off your engine and restart only when you're ready to go.
 - Don't "lug" or "over-rev" the engine. Lugging is driving too slowly in too high a gear resulting in the engine bucking. If this happens, shift to a lower gear. Over-revving is racing the engine beyond its safe limit. This can be

avoided by shifting at the recommended speeds.

- Open windows at high speeds can reduce fuel economy.
- Fuel economy is less in crosswinds and headwinds. To help offset some of this loss, slow down when driving in these conditions.

Keeping a vehicle in good operating condition is important both for economy and safety.

Therefore, have an authorized Kia dealer perform scheduled inspections and maintenance.

WARNING

Engine off during motion

Never turn the engine off to coast down hills or anytime the vehicle is in motion. The power steering and power brakes will not function properly without the engine running. In addition, turning off the ignition while driving could engage the steering wheel lock resulting in loss of vehicle steering. Keep the engine on and downshift to an appropriate gear for engine braking effect.

Special driving conditions

If driving conditions deteriorate due to poor weather or road conditions, you should pay even more attention than usual to your driving.

Hazardous driving conditions

When hazardous driving conditions are encountered such as water, snow, ice, mud, sand, or similar hazards, follow these suggestions:

- Drive cautiously and allow extra distance for braking.
- Avoid sudden braking or steering.
- When braking with non-ABS brakes pump the brake pedal with a light up-and-down motion until the vehicle is stopped.
- Do not pump the brake pedal on a vehicle equipped with ABS.
- If stalled in snow, mud, or sand, use the second gear. Accelerate slowly to avoid spinning the drive wheels.
- Use sand, rock salt, or other non-slip material under the drive wheels to provide traction when stalled in ice, snow, or mud.

Reducing the risk of a rollover

This multi-purpose passenger vehicle is defined as a Sports Utility Vehicle (SUV).

SUV's have higher ground clearance and a narrower track to make them capable of performing in a wide

variety of road applications. Specific design characteristics give them a higher center of gravity than ordinary vehicles. An advantage of the higher ground clearance is a better view of the road, which allows you to anticipate problems. They are not designed for cornering at the same speeds as conventional passenger vehicles. Due to this risk, driver and passengers are strongly recommended to buckle their seat belts. In a rollover crash, an unbelted person is more likely to die than a person wearing a seat belt. There are steps that a driver can make to reduce the risk of a rollover. If at all possible, avoid sharp turns or abrupt maneuvers, do not load your roof rack with heavy cargo, and never modify your vehicle in any way.

WARNING

Rollover

As with other Sports Utility Vehicle (SUV), failure to operate this vehicle correctly may result in loss of control, an accident or vehicle rollover.

- Utility vehicles have a significantly higher rollover rate than other types of vehicles.
- Specific design characteristics (higher ground clearance, narrower track, etc.) give this vehicle a higher center of gravity than ordinary vehicles.

- A SUV is not designed for cornering at the same speeds as conventional vehicles.
- Avoid sharp turns or abrupt maneuvers.
- In a rollover crash, an unbelted person is significantly more likely to die than a person wearing a seat belt. Make sure everyone in the vehicle is properly buckled up.

WARNING

Your vehicle is equipped with tires designed to provide safe riding and handling capability. Do not use tires and wheels that are different in size and type from the originally installed ones. It can affect the safety and performance of your vehicle, which could lead to steering failure or rollover and serious injury. When replacing the tires, be sure to equip all four tires with the tire and wheel of the same size, type, tread, brand and load-carrying capacity.

Rocking the vehicle

If it is necessary to rock the vehicle to free it from snow, sand, or mud, first turn the steering wheel right and left to clear the area around your front wheels. Then, shift back and forth between R (Reverse) and any forward gear.

Do not race the engine, and spin the wheels as little as possible. If you are still stuck after a few tries, have the vehicle pulled out by a tow vehicle to avoid engine overheating and possible damage to the transmission.

WARNING

Sudden Vehicle Movement

Do not attempt to rock the vehicle if people or objects are nearby. The vehicle may suddenly move forward or backwards as it becomes unstuck.

CAUTION

Vehicle rocking

Prolonged rocking may cause vehicle overheating, reduction gear damage or failure, and tire damage.

CAUTION

Spinning tires

Do not spin the wheels, especially at speeds more than 35 mph (56 km/h). Spinning the wheels at high speeds when the vehicle is stationary could overheat and damage tires, and the rotating wheels may fly away and injure bystanders.

The Electronic Stability Control (ESC) should be turned OFF prior to rocking the vehicle.

Smooth cornering

Avoid braking or gear changing in corners, especially when roads are wet. Ideally, corners should always be taken under gentle acceleration. If you follow these suggestions, tire wear will be held to a minimum.

Driving at night

Because night driving presents more hazards than driving in the daylight, here are some important tips to remember:

- Slow down and keep more distance between you and other vehicles, as it may be more difficult to see at night, especially in areas where there may not be any street lights.
- Adjust your mirrors to reduce the glare from other driver's headlights.
- Keep your headlights clean and properly aimed. (On vehicles not equipped with the automatic headlight aiming feature.) Dirty or improperly aimed headlights will make it much more difficult to see at night.
- Avoid staring directly at the headlights of oncoming vehicles. You could be temporarily blinded, and it will take several seconds for

your eyes to readjust to the darkness.

Driving in the rain

Rain and wet roads can make driving dangerous, especially if you're not prepared for the slick pavement.

Here are a few things to consider when driving in the rain:

- A heavy rainfall will make it harder to see and will increase the distance needed to stop your vehicle, so slow down.
- Keep your windshield wiping equipment in good shape. Replace your windshield wiper blades when they show signs of streaking or missing areas on the windshield.
- If your tires are not in good condition, making a quick stop on wet pavement can cause a skid and possibly lead to an accident. Be sure your tires are in good shape.
- Turn on your headlights to make it easier for others to see you.
- Driving too fast through large puddles can affect your brakes. If you must go through puddles, try to drive through them slowly.
- If you believe you may have gotten your brakes wet, apply them lightly while driving until normal braking operation returns.

Driving in flooded areas

Avoid driving through flooded areas unless you are sure the water is no higher than the bottom of the wheel hub. Drive through any water slowly. Allow adequate stopping distance because brake performance may be affected.

After driving through water, dry the brakes by gently applying them several times while the vehicle is moving slowly.

Driving on unpaved roads

Drive carefully on unpaved roads because your vehicle may be damaged by rocks or roots of trees. Become familiar with the on unpaved roads conditions where you are going to drive before you begin driving.

Highway driving

Tires

Adjust the tire inflation pressures to specification. Low tire inflation pressures will result in overheating and possible failure of the tires.

Avoid using worn or damaged tires which may result in reduced traction or tire failure.

Never exceed the maximum tire inflation pressure shown on the tires.

⚠ WARNING**Under/over inflated tires**

Always check the tires for proper inflation before driving. Underinflated or overinflated tires can cause poor handling, loss of vehicle control, and sudden tire failure, leading to accidents, injuries, and even death. For proper tire pressures, refer to "Tires and wheels" on page 8-6.

⚠ WARNING**Tire tread**

Always check the tire tread before driving your vehicle. Worn-out tires can result in loss of vehicle control. Worn-out tires should be replaced as soon as possible. For further information and tread limits, refer to "Tires and wheels" on page 8-6.

Fuel, engine coolant and engine oil

High speed travel consumes more fuel than urban motoring. Do not forget to check both the engine coolant and engine oil.

Drive belt

A loose or damaged drive belt may result in overheating of the engine.

Winter driving

Severe weather conditions in the winter result in greater wear and other problems.

To minimize the problems of winter driving, you should follow these suggestions:

Snowy or icy conditions

To drive your vehicle in deep snow, it may be necessary to use snow tires or to install tire chains on your tires.

If snow tires are needed, it is necessary to select tires equivalent in size and type of the original equipment tires. Failure to do so may adversely affect the safety and handling of your vehicle. Furthermore, speeding, rapid acceleration, sudden brake applications, and sharp turns are potentially very hazardous practices.

During deceleration, use vehicle braking to the fullest extent. Sudden brake applications on snowy or icy roads may cause skids to occur. You need to keep sufficient distance between the vehicle in operation in front of your vehicle. Also, apply the brake gently. It should be noted that installing tire chains on the tire will provide a greater driving force, but will not prevent side skids.

Tire chains are not legal in all states. Check state laws before fitting tire chains.

Snow tires

If you mount snow tires on your vehicle, make sure they are radial tires of the same size and load range as the original tires. Mount snow tires on all four wheels to balance your vehicle's handling in all weather conditions. Keep in mind that the traction provided by snow tires on dry roads may not be as high as your vehicle's original equipment tires. You should drive cautiously even when the roads are clear. Check with the tire dealer for maximum speed recommendations.

Do not install studded tires without first checking local, state and municipal regulations for possible restrictions against their use.

⚠ WARNING

Snow tire size

Snow tires should be equivalent in size and type to the vehicle's standard tires. Otherwise, the safety and handling of your vehicle may be adversely affected.

Tire chains



Since the sidewalls of radial tires are thinner, they can be damaged by mounting some types of snow chains on them. Therefore, the use of snow tires is recommended instead of snow chains. Do not mount tire chains on vehicles equipped with aluminum wheels; snow chains may cause damage to the wheels. If snow chains must be used, use fabric-type chains or wire-type chains with a thickness of less than 0.47 in (12 mm).

Damage to your vehicle caused by improper tire chain use is not covered by your vehicle manufacturer's warranty.

When using tire chains, attach them to the drive wheels as follows.

- * FWD/AWD: Front Wheel Drive
 - Front wheel drive vehicle moves the front wheel as a power source. Thus, snow chains must be mounted to front tires.
 - All wheel drive vehicle must mount snow chains to front tires only. In this case, minimize the driving distance in order to prevent damage to the all wheel drive system.
 - After mounting snow chains, drive slowly. If you hear noise caused by chains contacting the body, slow down until the noise stops and remove the chain as soon as you begin driving on cleared roads to prevent damage.
 - Wrong size chains or improperly installed chains can damage your vehicle's brake lines, suspension, body and wheels. Therefore, when installing snow chain, follow the manufacturer's instructions and mount them as tightly possible. Drive slowly (less than 20 mph (30 km/h)) with chains installed.

CAUTION

- Make sure the snow chains are the correct size and type for your tires. Incorrect snow chains can cause damage to the vehicle body and suspension and may not be covered by your vehicle manufacturer warranty. Also, the snow chain connecting hooks may be damaged from contacting vehicle components causing the snow chains to come loose from the tire. Make sure the snow chains are SAE class "S" certified.
- Always check chain installation for proper mounting after driving approximately 0.3 to 0.6 miles (0.5 to 1 km) to ensure safe mounting. Retighten or remount the chains if they are loose.

Use high quality ethylene glycol coolant

Your vehicle is delivered with high quality ethylene glycol coolant in the cooling system. It is the only type of coolant that should be used because it helps prevent corrosion in the cooling system, lubricates the water pump and prevents freezing. Be sure to replace or replenish your coolant refer to "Normal maintenance schedule – Non Turbo Models" on page 7-12. Before winter, have your coolant tested to assure that its freezing point is sufficient for

the temperatures anticipated during the winter.

Check battery and cables

Winter puts additional burdens on the battery system. Visually inspect the battery and cables (refer to "For best battery service" on page 7-39). The level of charge in your battery can be checked by an authorized Kia dealer or a service station.

Change to "winter weight" oil if necessary

In some climates it is recommended that a lower viscosity "winter weight" oil be used during cold weather. Refer to "Recommended lubricants and capacities" on page 8-7 for recommendations. If you aren't sure what weight oil you should use, consult an authorized Kia dealer.

Check spark plugs and ignition system

Inspect your spark plugs as described in "Scheduled maintenance service" on page 7-10 and replace them if necessary. Also, check all ignition wiring and components to be sure they are not cracked, worn or damaged in any way.

To keep locks from freezing

To keep the locks from freezing, squirt an approved de-icer fluid or glycerine into the key opening. If a lock is covered with ice, squirt it with an approved de-icing fluid to remove the ice. If the lock is frozen internally, you may be able to thaw it out by using a heated key. Handle the heated key with care to avoid injury.

Use approved window washer anti-freeze in system

To keep the water in the window washer system from freezing, add an approved window washer anti-freeze solution in accordance with instructions on the container. Window washer anti-freeze is available from an authorized Kia dealer and most auto parts outlets. Do not use vehicle coolant or other types of anti-freeze as these may damage the paint finish.

Don't let your parking brake freeze

Under some conditions your parking brake can freeze in the engaged position. This is most likely to happen when there is an accumulation of snow or ice around or near the rear brakes or if the brakes are wet. If there is a risk the parking brake may freeze, apply it only temporarily while you put the gear shift dial in P (Park) and block the rear wheels

so the vehicle cannot roll. Then release the parking brake.

Don't let ice and snow accumulate underneath

Under some conditions, snow and ice can build up under the fenders and interfere with the steering. In severe winter conditions you should periodically check underneath the vehicle to be sure the movement of the front wheels and the steering components are not obstructed.

Carry emergency equipment

Depending on the severity of the weather, you should carry appropriate emergency equipment. Some of the items you may want to carry include tow straps or chains, flashlight, emergency flares, sand, shovel, jumper cables, window scraper, gloves, ground cloth, coveralls, blanket, etc.

Trailer towing

We do not recommend using this vehicle for trailer towing.

Vehicle load limit

The vehicle load limit is displayed on the tire and loading information label on the driver's door.

Tire and loading information label

The label located on the driver's door sill gives the original tire size, cold tire pressures recommended for your vehicle, the number of people that can be in your vehicle and vehicle capacity weight.



Vehicle capacity weight:

860 lbs. (390 kg)

Vehicle capacity weight is the maximum combined weight of occupants and cargo. If your vehicle is equipped with a trailer, the combined weight includes the tongue load.

Seating capacity:

Total: 5 persons (Front seat: 2 persons, Rear seat: 3 persons)

Seating capacity is the maximum number of occupants including a driver, your vehicle may carry. However, the seating capacity may be reduced based upon the weight of all of the occupants, and the weight of the cargo being carried or towed.

Do not overload the vehicle as there is a limit to the total weight, or load limit including occupants and cargo, the vehicle can carry.

Towing capacity:

We do not recommend using this vehicle for trailer towing.

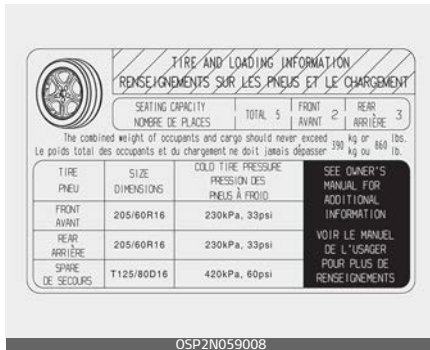

Cargo capacity:

The cargo capacity of your vehicle will increase or decrease depending on the weight and the number of occupants.

Steps For Determining Correct Load Limit -

1. Locate the statement "The combined weight of occupants and cargo should never exceed XXX kg or XXX lbs" on your vehicle's placard.
2. Determine the combined weight of the driver and passengers that will be riding in your vehicle.
3. Subtract the combined weight of the driver and passengers from XXX kg or XXX lbs.
4. The resulting figure equals the available amount of cargo and luggage load capacity. For example, if the "XXX" amount equals 1400 lbs. and there will be five 150 lbs. passengers in your vehicle, the amount of available cargo and luggage load capacity is 650 lbs. (1400-750 (5 × 150) = 650 lbs.)
5. Determine the combined weight of luggage and cargo being loaded on the vehicle. That weight may not safely exceed the available cargo and luggage load capacity calculated in Step 4.
6. If your vehicle will be towing a trailer, load from your trailer will be transferred to your vehicle. Consult this manual to determine how this reduces the available

cargo and luggage load capacity of your vehicle.

⚠ WARNING

Loose cargo

Do not travel with unsecured blunt objects in the passenger compartment of your vehicle (e.g. suit cases or unsecured child seats). These items may strike occupant during a sudden stop or crash.

Example 1

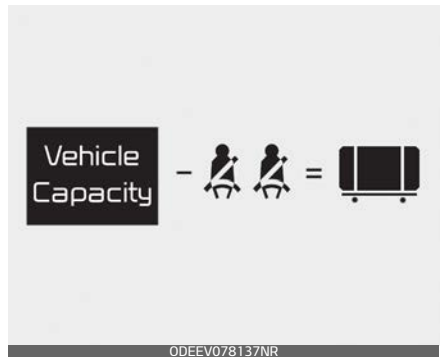

Item	Description	Total
A	Vehicle Capacity Weight	849 lbs. (385 kg)
B	Subtract Occupant Weight 150 lbs. (68 kg)×2	300 lbs. (136 kg)
C	Available Cargo and Luggage weight	549 lbs. (249 kg)

Example 2

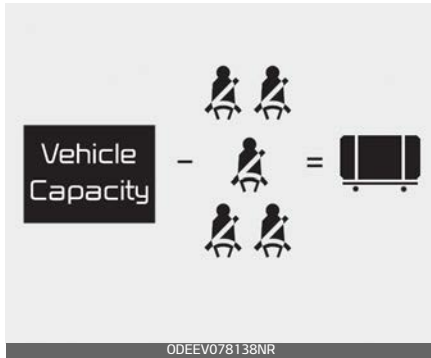

Item	Description	Total
A	Vehicle Capacity Weight	849 lbs. (385 kg)
B	Subtract Occupant Weight 150 lbs. (68 kg)×5	750 lbs. (340 kg)
C	Available Cargo and Luggage weight	99 lbs. (45 kg)

Example 3

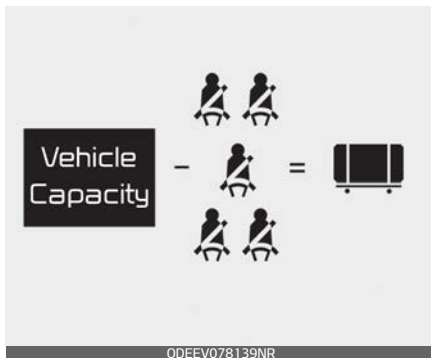

Item	Description	Total
A	Vehicle Capacity Weight	849 lbs. (385 kg)

Item	Description	Total
B	Subtract Occupant Weight 161 lbs. (73 kg)×5	805 lbs. (365 kg)
C	Available Cargo and Luggage weight	44 lbs. (20 kg)

Refer to your vehicle's tire and loading information label for specific information about your vehicle's capacity weight and seating positions. The combined weight of the driver, passengers and cargo should never exceed your vehicle's capacity weight.

Certification label

The certification label is located on the driver's door sill at the center pillar.



This label shows the maximum allowable weight of the fully loaded vehicle. This is called the GVWR (Gross Vehicle Weight Rating). The GVWR includes the weight of the vehicle, all occupants and cargo.

This label also tells you the maximum weight that can be supported by the front and rear axles, called Gross Axle Weight Rating (GAWR).

To find out the actual loads on your front and rear axles, you need to go to a weigh station and weigh your vehicle. Your dealer can help you with this. Be sure to spread out your load equally on both sides of the centerline.

WARNING

Over loading

Never exceed the GVWR for your vehicle, the GAWR for either the front or rear axle and vehicle capacity weight. Exceeding these ratings can affect your vehicle's handling and braking ability.

The label will help you decide how much cargo and installed equipment your vehicle can carry.

If you carry items inside your vehicle – like suitcases, tools, packages, or anything else – they are moving as fast as the vehicle. If you have to stop or turn quickly, or if there is a crash, the items will keep going and can cause an injury if they strike the driver or a passenger.

WARNING

Over loading

Do not overload your vehicle. Overloading your vehicle can cause heat buildup in your vehicle's tires and possible tire failure, increased stopping distances and poor vehicle handling—all of which may result in a crash.

NOTICE

Overloading your vehicle may cause damage. Repairs would not be covered by your warranty. Do not overload your vehicle.

Vehicle weight

This chapter will guide you in the proper loading of your vehicle and/or trailer, to keep your loaded vehicle weight within its design rating capability, with or without a trailer.

Properly loading your vehicle will provide maximum return of the vehicle design performance. Before loading your vehicle, familiarize yourself with the following terms for determining your vehicle's weight ratings, with or without a trailer, from the vehicle's specifications and the compliance label:

Base curb weight This is the weight of the vehicle including a full tank of fuel and all standard equipment. It does not include passengers, cargo, or optional equipment.

Vehicle curb weight This is the weight of your new vehicle when you picked it up from your dealer plus any aftermarket equipment.

Cargo weight This figure includes all weight added to the Base Curb Weight, including cargo and optional equipment.

GAW (Gross Axle Weight) This is the total weight placed on each axle (front and rear) - including vehicle curb weight and all payload.

GAWR (Gross Axle Weight Rating)

This is the maximum allowable weight that can be carried by a single axle (front or rear). These numbers are shown on the compliance label. The total load on each axle must never exceed its GAWR.

GVW (Gross Vehicle Weight) This is the Base Curb Weight plus actual Cargo Weight plus passengers.

GVWR (Gross Vehicle Weight Rating)

This is the maximum allowable weight of the fully loaded vehicle (including all options, equipment, passengers and cargo). The GVWR is shown on the certification label located on the driver's door sill.

CAUTION

Do not use replacement tires with lower load carrying capacities than the original tires because they may lower your vehicle's GVWR and GAWR limitations. Replacement tires with a higher limit than the original tires do not increase the GVWR and GAWR limitations.

Road warning	6-3
• Hazard warning flasher	6-3
In case of an emergency while driving	6-4
• If the vehicle stalls while driving.....	6-4
• If the engine stalls at a crossroad or crossing	6-4
• If you have a flat tire while driving.....	6-4
If the engine will not start	6-5
• If engine doesn't turn over or turns over slowly	6-5
• If engine turns over normally but does not start.....	6-5
Emergency starting	6-6
• Jump-starting	6-6
• Push-starting.....	6-7
If the engine overheats	6-8
Tire Pressure Monitoring System (TPMS)	6-10
• Effective use of the TPMS.....	6-11
• Low tire pressure telltale	6-12
• TPMS malfunction indicator	6-13
• Tire replacement with TPMS.....	6-14
• This device complies with Part 15 of the FCC rules.	6-15
If you have a flat tire (with spare tire)	6-16
• Jack and tools.....	6-16
• Changing tires	6-18
• Important - use of compact spare tire	6-23
• Jack label	6-25
Towing	6-26
• Towing without wheel dollies when using a towing service	6-27
• Using removable towing hook	6-28

6 What to do in an emergency

- Emergency towing6-28

WHAT TO DO IN AN EMERGENCY

Road warning

When in an emergency situation occurs while driving or when you park by the edge of the roadway, you must alert approaching or passing vehicles to be careful as they pass. For this, you should use the hazard warning flasher.

Hazard warning flasher

The hazard warning flasher serves as a warning to other drivers to exercise extreme caution when approaching, overtaking, or passing your vehicle.

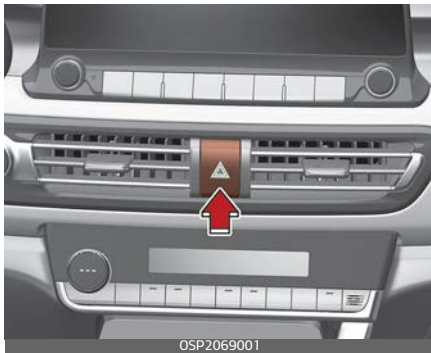

It should be used whenever emergency repairs are being made or when the vehicle is stopped near the edge of a roadway.

Depress the flasher switch with the ENGINE START/STOP button in any position. The flasher switch is located in the center fascia panel. All turn signal lights will flash simultaneously.

- The hazard warning flasher operates whether your vehicle is running or not.
- The turn signals do not work when the hazard flasher is on.
- Care must be taken when using the hazard warning flasher while the vehicle is being towed.

In case of an emergency while driving

If an emergency situation occurs while driving, stay calm and take the following steps.

If the vehicle stalls while driving

1. Reduce your speed gradually, keeping a straight line.
2. Move cautiously off the road to a safe place.
3. Turn on your hazard warning flasher.
4. Try to start the vehicle again. If your vehicle will not start, contact an authorized Kia dealer or seek other qualified assistance.

If the engine stalls at a crossroad or crossing

- If the engine stalls at a crossroad or crossing, set the shift lever in the N (Neutral) position and then push the vehicle to a safe place.
- If your vehicle has a manual transmission not equipped with a ignition lock switch, the vehicle can move forward by shifting to the 2 (second) or 3 (third) gear and then turning the starter without depressing the brake pedal.

If you have a flat tire while driving

1. Take your foot off the accelerator pedal and let the vehicle slow down while driving straight ahead. Do not apply the brakes immediately or attempt to pull off the road as this may cause a loss of control.
2. When the vehicle has slowed to such a speed that it is safe to do so, brake carefully and pull off the road.
3. Drive off the road as far as possible and park on firm level ground. If you are on a divided highway, do not park in the median area between the two traffic lanes.
4. When the vehicle is stopped, turn on your emergency hazard flashers, set the parking brake and put the transmission in P.
5. Have all passengers get out of the vehicle. Be sure they all get out on the side of the vehicle that is away from traffic.
6. When changing a flat tire, follow the instruction provided later in this section.

If the engine will not start

When the engine doesn't start, first check to see how much fuel there is and whether the battery is discharged.

If engine doesn't turn over or turns over slowly

1. Be sure the shift lever is in N (Neutral) or P (Park) and the emergency brake is set.
2. Check the battery connections to be sure they are clean and tight.
3. Turn on the interior light. If the light dims or goes out when you operate the starter, the battery is discharged.
4. Check the starter connections to be sure they are securely tightened.

Do not push or pull the vehicle to start it. This could cause damage to your vehicle. Refer to "Jump-starting" on page 6-6.

WARNING

Push/pull start

Do not push or pull the vehicle to start it. Push or pull starting may cause the catalytic converter to overload and create a fire hazard.

If engine turns over normally but does not start

1. Check the fuel level.
2. With the ENGINE START/STOP button in the OFF position, check all connectors at the ignition coils and spark plugs. Reconnect any that may be disconnected or loose.
3. Check the fuel line in the engine compartment.
4. If the engine still does not start, call an authorized Kia dealer or seek other qualified assistance.

Emergency starting

When the vehicle will not start because of low battery power, you may need to jump start the vehicle.

Jump-starting

Connect cables in numerical order and disconnect in reverse order.

(Gasoline) 1.6 T-GDi

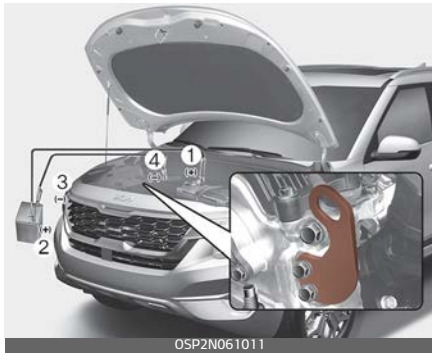

(Gasoline) 2.0 MPI

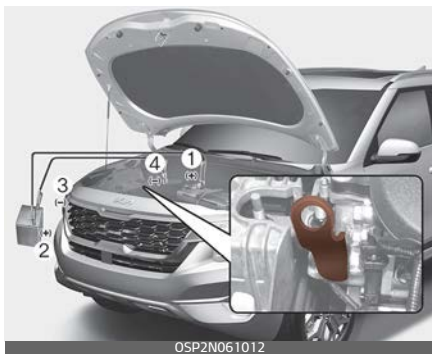

Jump-starting can be dangerous if done incorrectly. Therefore, to avoid harm to yourself or damage to your vehicle or battery, follow these jump-starting procedures. If in

doubt, we strongly recommend that you have a competent technician or towing service jump-start your vehicle.

⚠ WARNING

Battery

Never attempt to check the electrolyte level of the battery, as this may cause the battery to rupture or explode.

⚠ WARNING

Frozen batteries

Do not attempt to jump start the vehicle if the discharged battery is frozen, as the battery may rupture or explode.

⚠ WARNING

Battery

Keep all flames or sparks away from the battery. The battery produces hydrogen gas, which will explode if exposed to flame or sparks.

⚠ WARNING

Battery cables

Do not connect the jumper cable from the negative terminal of the booster battery to the negative terminal of the discharged battery, directly. This can cause the dis-

charged battery to overheat and crack or degrade.

Make sure to connect one end of the jumper cable to the negative terminal of the booster battery, and the other end to a metallic point, far away from the battery.

WARNING

Sulfuric acid risk

Automobile batteries contain sulfuric acid. When jump starting your vehicle, be careful not to get sulfuric acid on yourself, your clothing, or on the vehicle. This acid is poisonous and highly corrosive.

Jump-starting

1. Make sure the booster battery is 12-volt and that its negative terminal is grounded.
If the booster battery is in another vehicle, do not allow the vehicles to come in contact.
2. Turn off all unnecessary electrical loads.
3. Connect the jumper cables in the exact sequence shown in the illustration.
 - 1) Connect one end of a jumper cable to the positive terminal of the discharged battery (1).
 - 2) Connect the other end to the positive terminal of the booster battery (2).
 - 3) Proceed to connect one end of the other jumper cable to the

negative terminal of the booster battery (3), then the other end to a solid, stationary, metallic point away from the battery (4).

Do not allow the jumper cables to contact anything except the correct battery terminals or the correct ground. Do not lean over the battery when making connections.

4. Start vehicle with the booster battery and let it run at 2,000 rpm, then start the vehicle with the discharged battery.

If the cause of your battery discharging is not apparent, you should have your vehicle checked by an authorized Kia dealer.

NOTICE

Make sure to connect one end of the jumper cable to the negative terminal of the booster battery, and the other end to a metallic point, far away from the battery.

Push-starting

Vehicles equipped with automatic transmission cannot be push-started, and only jump starting can be applied. Follow the directions in this section for "Jump-starting" on page 6-6.

WARNING
Tow starting vehicle

Never tow a vehicle to start it.

When the engine starts, the vehicle can suddenly surge forward and could cause a collision with the tow vehicle.

If the engine overheats

If your temperature gauge indicates overheating, you experience a loss of power, or hear a loud pinging or knocking, the engine will probably be too hot.

If this happens, you should:

1. Pull off the road and stop as soon as it is safe to do so.
2. Place the shift lever in P and set the parking brake.
3. If the air conditioning is on, turn it off.
4. If engine coolant is running out under the vehicle or steam is coming out from underneath the hood, stop the engine. Do not open the hood until the coolant has stopped running or the steaming has stopped.
5. If there is no visible loss of engine coolant and no steam, leave the engine running and check to be sure the engine cooling fan is operating.
 - 1) If the fan is not running, turn the engine off.
6. Check to see if the water pump drive belt is missing.
 - 1) If it is not missing, check to see that it is tight.
 - 2) If the drive belt seems to be satisfactory, check for coolant leaking from the radiator, hoses or under the vehicle. (If the air conditioning had been in use, it is normal for cold water to be draining from it when you stop).

⚠ WARNING**Under the hood**

While the engine is running, keep hair, hands and clothing away from moving parts, such as the fan and drive belts, to prevent injury.

7. If the water pump drive belt is broken or engine coolant is leaking out, stop the engine immediately and call the nearest authorized Kia dealer for assistance.
8. If you cannot find the cause of the overheating, wait until the engine temperature has returned to normal. If coolant has been lost, carefully add coolant to the reservoir to bring the fluid level in the reservoir up to the halfway mark.
9. Proceed with caution, keeping alert for further signs of overheating. If overheating happens again, call an authorized Kia dealer for assistance.

⚠ WARNING**Radiator cap**

Do not remove the radiator cap when the engine is hot. This may result in coolant being blown out of the opening and cause serious burns.

*** NOTICE**

- Serious loss of coolant indicates there is a leak in the cooling system and this should be checked as soon as possible by an authorized Kia dealer.
- When the engine overheats from low engine coolant, suddenly adding engine coolant may cause cracks in the engine. To prevent damage, add engine coolant slowly in small quantities.

Tire Pressure Monitoring System (TPMS)

The Tire Pressure Monitoring System (TPMS) detects the pressure of vehicle's tires and displays it on the LCD display.



OSP2N061001



OSP2N049102

1. Low tire pressure telltale / TPMS malfunction indicator
2. Low tire pressure position telltale (Shown on the LCD display)

Tire Pressure Indicator

- You can check the tire pressure in the assist mode on the cluster.
 - Refer to "Driving Assist mode" on page 4-60.
- Tire pressure is displayed 1~2 minutes later after driving.
- If tire pressure is not displayed when the vehicle is stopped, "Drive to display" message displays. After driving, check the tire pressure.
- You can change the tire pressure unit in the user settings mode on the cluster.
 - psi, kPa, bar (Refer to "User Settings mode" on page 4-61).

* NOTICE

- The tire pressure may change due to factors such as parking condition, driving style, and altitude above sea level.
- The tire pressure shown on the dashboard may differ from the tire pressure measured by tire pressure gauge.

Effective use of the TPMS

WARNING

Over-inflation or under-inflation can reduce tire life, adversely affect vehicle handling, and lead to sudden tire failure that may cause loss of vehicle control resulting in an accident

Each tire, including the spare (if provided), should be checked monthly when cold and inflated to the inflation pressure recommended by the vehicle manufacturer on the vehicle placard or tire inflation pressure label.

(If your vehicle has tires of a different size than the size indicated on the vehicle placard or tire inflation pressure label, you should determine the proper tire inflation pressure for those tires.)

As an added safety feature, your vehicle has been equipped with a tire pressure monitoring system (TPMS) that illuminates a low tire pressure telltale when one or more of your tires is significantly under-inflated. Accordingly, when the low tire pressure telltale illuminates, you should stop and check your tires as soon as possible, and inflate them to the proper pressure. Driving on a significantly under-inflated tire causes the tire to overheat and can

lead to tire failure. Under-inflation also reduces fuel efficiency and tire tread life, and may affect the vehicle's handling and stopping ability.

Please note that the TPMS is not a substitute for proper tire maintenance, and it is the driver's responsibility to maintain correct tire pressure, even if under-inflation has not reached the level to trigger illumination of the TPMS low tire pressure telltale.

Your vehicle has also been equipped with a TPMS malfunction indicator to indicate when the system is not operating properly. The TPMS malfunction indicator is combined with the low tire pressure telltale. When the system detects a malfunction, the telltale will flash for approximately one minute and then remain continuously illuminated. This sequence will continue upon subsequent vehicle start-ups as long as the malfunction exists. When the malfunction indicator is illuminated, the system may not be able to detect or signal low tire pressure as intended. TPMS malfunctions may occur for a variety of reasons, including the installation of replacement or alternate tires or wheels on the vehicle that prevent the TPMS from functioning properly.

Always check the TPMS malfunction telltale after replacing one or more tires or wheels on your vehicle to ensure that the replacement or alternate tires and wheels allow the TPMS to continue to function properly.

*** NOTICE**

If any of the below happens, have the system checked by an authorized Kia dealer.

1. The low tire pressure telltale/ TPMS malfunction indicator does not illuminate for 3 seconds when the ENGINE START/STOP button is turned to the ON position or engine is running.
2. The TPMS malfunction indicator remains illuminated after blinking for approximately 1 minute.
3. The Low tire pressure position telltale remains illuminated.

Low tire pressure telltale (!)

Low tire pressure position telltale

When the TPMS warning indicators are illuminated, one or more of your tires is significantly under-inflated.



If the telltale illuminates, immediately reduce your speed, avoid hard cornering and anticipate increased stopping distances. You should stop and check your tires as soon as possible.

Inflate the tires to the proper pressure as indicated on the vehicle's placard or tire inflation pressure label located on the driver's side center pillar outer panel. If you cannot reach a service station or if the tire cannot hold the newly added air, replace the low pressure tire with the spare tire.

Then the TPMS malfunction indicator and the Low Tire Pressure telltale may turn on and illuminate after restarting and about 20 minutes of continuous driving before you have the low pressure tire repaired and replaced on the vehicle.

In winter or cold weather, the low tire pressure telltale may be illuminated if the tire pressure was adjusted to the recommended tire

inflation pressure in warm weather. It does not mean your TPMS is malfunctioning because the decreased temperature leads to a proportional lowering of tire pressure.

You should check the tire inflation pressure and adjust the tires to the recommended tire inflation pressure when driving your vehicle in the following conditions.

- from a warm area to a cold area
- from a cold area to a warm area
- the outside temperature is extremely high or low

When filling tires with more air, conditions to turn off the low tire pressure telltale may not be met. This is because a tire inflator has a margin of error in performance. The low tire pressure telltale will be turned off if the tire pressure is above the recommended tire inflation pressure.

WARNING

Low pressure damage

Do not drive on low pressure tires. Significantly low tire pressure can cause the tires to overheat and fail, making the vehicle unstable, resulting in increased braking distances and a loss of vehicle control.

TPMS malfunction indicator

The low tire pressure telltale will illuminate after it blinks for approximately one minute when there is a problem with the TPMS.

If the system is able to correctly detect an underinflation warning at the same time as system failure, it will illuminate both the TPMS malfunction and the low tire pressure position telltales. For example, if the Front Left sensor fails, the TPMS malfunction indicator illuminates, but if the Front Right, Rear Left, or Rear Right tire is underinflated, the low tire pressure position telltales may illuminate together with the TPMS malfunction indicator.

Have the system checked by an authorized Kia dealer as soon as possible to determine the cause of the problem.

- The TPMS malfunction indicator may be illuminated if the vehicle is moving around electric power supply cables or radios transmitters such as at police stations, government and public offices, broadcasting stations, military installations, airports, or transmitting towers, etc. This can interfere with normal operation of the TPMS.

- The TPMS malfunction indicator may illuminate if the vehicle is equipped with snow chains or some personal electronic devices (such as a laptop computer, mobile charger, remote starter or navigation) are being used in the vehicle. This can interfere with normal operation of the TPMS.

Tire replacement with TPMS

If you have a flat tire, the Low Tire Pressure telltale will come on. Have the flat tire repaired by an authorized Kia dealer as soon as possible or replace the flat tire with the spare tire.



Repair Agents

Never use a puncture-repairing agent not approved by Kia to repair and/or inflate a low pressure tire. Sealant that is not approved by Kia may damage the tire pressure sensor.

Each wheel is equipped with a tire pressure sensor mounted inside the tire behind the valve stem. You must use TPMS specific wheels. Have always your tires serviced by an authorized Kia dealer.

Even if you replace the low pressure tire with the spare tire, the Low Tire Pressure telltale will remain on until

the low pressure tire is repaired and placed on the vehicle.

After you replace the low pressure tire with the spare tire, the TPMS malfunction indicator may illuminate after a few minutes. This is because the TPMS sensor mounted on the spare wheel is not yet activated.

Once the low pressure tire is inflated again to the recommended pressure and installed on the vehicle or the TPMS sensor mounted on the replaced spare wheel is initiated by an authorized Kia dealer, the TPMS malfunction indicator and the low tire pressure telltale will turn off within a few minutes of driving.

If the indicator has not disappeared after a few minutes of driving, please visit an authorized Kia dealer.

If an original mounted tire is replaced with the spare tire, the TPMS sensor on the replaced spare wheel should be initiated and the TPMS sensor on the original mounted wheel should be deactivated. If the TPMS sensor on the original mounted wheel located in the spare tire carrier still activates, the Tire Pressure Monitoring System may not operate properly. Have the tire with TPMS serviced or replaced by an authorized Kia dealer.

You may not be able to identify a low tire by simply looking at it. Always use a good quality tire pressure gauge to measure the tire's inflation pressure. Please note that a tire that is hot (from being driven) will have a higher pressure measurement than a tire that is cold (from sitting stationary for at least 3 hours and driven less than 1 mile (1.6 km) during that 3 hour period).

Allow the tire to cool before measuring the inflation pressure. Always be sure the tire is cold before inflating to the recommended pressure.

A cold tire means the vehicle has been sitting for 3 hours and driven for less than 1 mile (1.6 km) in that 3 hour period.

Never use tire sealant if your vehicle is equipped with a TPMS. The liquid sealant can damage the tire pressure sensors.

- The TPMS cannot alert you to severe and sudden tire damage caused by external factors such as nails or road debris.
- If you feel any vehicle instability, immediately take your foot off the accelerator, apply the brakes gradually and with light force, and slowly move to a safe position off the road.

* NOTICE

Protecting TPMS

Tampering with, modifying, or disabling the Tire Pressure Monitoring System (TPMS) components may interfere with the system's ability to warn the driver of low tire pressure conditions and/or TPMS malfunctions. Tampering with, modifying, or disabling the Tire Pressure Monitoring System (TPMS) components may void the warranty for that portion of the vehicle.

This device complies with Part 15 of the FCC rules.

Operation is subject to the following two conditions:

1. This device may not cause harmful interference, and
2. This device must accept any interference received, including interference that may cause undesired operation.
3. Changes or modifications not expressly approved by the party responsible for compliance could void the user's authority to operate the device.

If you have a flat tire (with spare tire)

If you have a flat tire, you can change the flat tire to a spare tire using tools.

⚠ WARNING

Driving on a flat tire will cause permanent damage to the tire. Re-inflating a tire after it has been driven on while severely underinflated or flat may cause a blowout and a serious crash. Never attempt to re-inflate a tire that has been driven on while severely underinflated or flat. In this case, repair or replace the flat tire as soon as possible.

⚠ WARNING

Changing a tire can be dangerous. Follow the instructions in this section when changing a tire to reduce the risk of serious injury or death.

⚠ CAUTION

Be careful as you use the jack handle to stay clear of the flat end. The flat end has sharp edges that could cause cuts.

Jack and tools (if equipped)

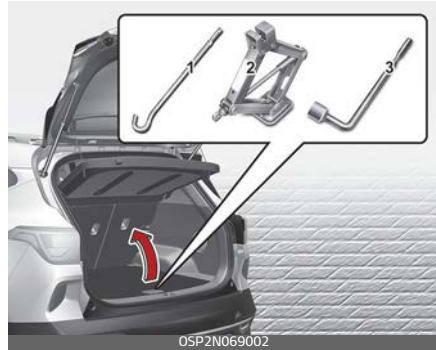

1. Jack handle
2. Jack
3. Wheel lug nut wrench

The jack and tools are stored in the luggage side trim.

Remove the tray cover indicated in the illustration.

Jacking instructions

The jack is provided for emergency tire changing only.

- To prevent the jack from "rattling" while the vehicle is in motion, store it properly.
- Follow jacking instructions to reduce the possibility of personal injury.

⚠ WARNING**Changing tires**

- Never attempt vehicle repairs in the traffic lanes of a public road or highway.
 - Always move the vehicle completely off the road and onto the shoulder before trying to change a tire. The jack should be used on firm level ground. If you cannot find a firm level place off the road, call a towing service company for assistance.
 - Be sure to use the correct front and rear jacking positions on the vehicle; never use the bumpers or any other part of the vehicle for jacking support.
 - The vehicle can roll off the jack causing serious injury or death.
 - Do not go under a vehicle that is supported by a jack.
 - Do not start or run the engine while the vehicle is on the jack.
 - Do not allow anyone to remain in the vehicle while it is on the jack.
 - Make sure any children present are in a secure place, away from the road and from the vehicle to be raised with the jack.
-

⚠ WARNING**Tire jack**

Do not place any portion of your body under a vehicle that is only supported by a jack since the vehicle can easily roll off the jack. Use vehicle support stands.

⚠ WARNING**Changing tires**

Never attempt vehicle repairs in the traffic lanes of a public road or highway.

⚠ WARNING**Running vehicle on jack**

Do not start or run the engine of the vehicle while the vehicle is on the jack as this may cause the vehicle to fall off the jack.

To prevent the jack from "rattling" while the vehicle is in motion, store it properly.

*** NOTICE****Retreaded tires**

Possibly substantial variations in the design and age of the tire casing structures can limit service life and have a negative impact on road safety.

Removing and storing the spare tire



- Turn the tire hold-down wing bolt counterclockwise to remove.
- Store the tire in the reverse order of removal.
- To prevent the spare tire and tools from "rattling" while the vehicle is in motion, store them properly.

⚠ WARNING

Touching surface of the luggage room floor

Do not touch the metal surface of the luggage room floor while the engine is operating or hot. Doing so could result in serious bodily injury. Turn the engine off and wait until it cools down or wear gloves to remove the spare tire from the luggage room.

If it is hard to loosen the tire hold-down wing bolt by hand, you can loosen it easily using the jack handle.



- Put the jack handle (1) inside of the tire hold-down wing bolt.
- Turn the tire hold-down wing bolt counterclockwise with the jack handle. Use caution when utilizing the sharp jack handle.

Changing tires

⚠ WARNING

A vehicle can slip or roll off of a jack causing serious injury or death to you or those nearby. Take the following safety precautions:

- Never place any portion of your body under a vehicle that is supported by a jack.
- NEVER attempt to change a tire in the lane of traffic. ALWAYS move the vehicle completely off the road on level, firm ground away

from traffic before trying to change a tire. If you cannot find a level, firm place off the road, call a towing service for assistance.

- Be sure to use the jack provided with the vehicle.
- ALWAYS place the jack on the designated jacking positions on the vehicle and NEVER on the bumpers or any other part of the vehicle for jacking support.
- Do not start or run the engine while the vehicle is on the jack.
- Do not allow anyone to remain in the vehicle while it is on the jack.
- Keep children away from the road and the vehicle.

1. Park on a level surface and apply the parking brake firmly.
2. Place the transmission shift lever in P (Park).
3. Activate the hazard warning flashers.



4. Remove the wheel lug nut wrench, jack and spare tire from the vehicle.



5. Block both the front and rear of the wheel that is diagonally opposite from the jack position.

⚠ WARNING

Jack location

To reduce the possibility of injury, be sure to only use the jack provided with the vehicle in the correct jack position; never use any other part of the vehicle for jack support.

⚠ WARNING

Changing a tire

- To prevent vehicle movement while changing a tire, always set the parking brake fully, and always block the wheel diagonally opposite the wheel being changed.

What to do in an emergency

- We recommend that the wheels of the vehicle be blocked, and that no person remain in a vehicle that is being jacked.

6. Loosen the wheel lug nuts counterclockwise one turn each, but do not remove any nut until the tire has been raised off the ground.



7. Place the jack at the front (1) or rear (2) jacking position closest to the tire you are changing. Place the jack at the designated locations under the frame. The jacking positions are plates welded to the frame with two tabs and a raised dot to line up with the jack.

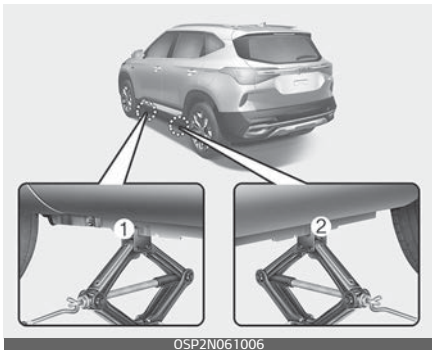

If you have a flat tire (with spare tire)

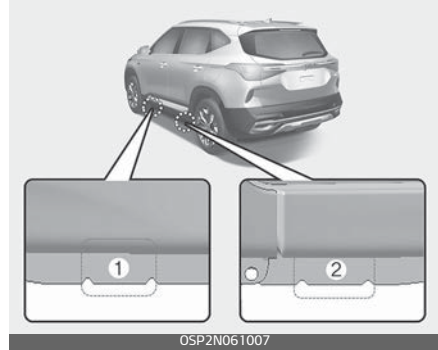

8. Insert the wheel lug nut wrench into the jack and turn it clockwise, raising the vehicle until the tire just clears the ground. This measurement is approximately 1 in (25 mm).



Before removing the wheel lug nuts, make sure the vehicle is stable and that there is no chance for movement or slippage.

9. Loosen the wheel nuts and remove them with your fingers.
10. Slide the wheel off the studs and lay it flat so it cannot roll away.
11. To put the wheel on the hub, pick up the spare tire, line up the holes with the studs and slide the wheel onto them. If this is difficult, tip

the wheel slightly and get the top hole in the wheel lined up with the top stud.

12. Jiggle the wheel back and forth until the wheel can slide over the other studs.

Wheels may have sharp edges. Handle them carefully to avoid possible severe injury. Before putting the wheel into place, be sure that there is nothing on the hub or wheel (such as mud, tar, gravel, etc.) that prevents the wheel from fitting solidly against the hub.

WARNING

Installing a wheel

- When you install a wheel, always remove any corrosion, dirt or foreign materials present on the mounting surfaces of the wheel or the surface of the wheel hub, brake drum or brake disc that contacts the wheel. Make sure to secure any fasteners that attach the rotor to the hub so they do not interfere with the mounting surfaces of the wheel. Installing wheels without correct metal-to-metal contact at the wheel mounting surfaces can cause the wheel nuts to loosen and the wheel to come off while your vehicle is in motion, resulting in loss of vehicle control, personal injury or death.
- Make sure the wheel makes good contact with the hub when installed. If the contact of the mounting surface between the wheel and hub is not good, the wheel nuts could come loose and cause the loss of a wheel. Loss of a wheel may result in loss of control of the vehicle.

WARNING

Wheel covers will not fit on the vehicle's compact spare. If you try to put a wheel cover on the compact spare, the cover or the spare could be damaged.

13. To install the wheel, hold it on the studs, put the wheel nuts on the studs and tighten them finger tight.
14. Jiggle the tire to be sure it is completely seated, then tighten the nuts as much as possible with your fingers again.
15. Insert the wrench into the jack and lower the vehicle to the ground by turning the wheel nut wrench counterclockwise.
16. Position the wrench as shown in the drawing and tighten the wheel nuts. Be sure the socket is seated completely over the nut. Do not stand on the wrench handle or use an extension pipe over the wrench handle.

17.Go around the wheel, tightening every nut following the numerical sequence shown in the image until they are all tight. Double-check each nut for tightness.



18.After changing wheels, have an authorized Kia dealer tighten the wheel nuts to their proper torque as soon as possible.

19.To prevent the jack, wheel lug nut wrench and spare tire from rattling while the vehicle is in motion, store them properly.

20.Check the inflation pressures as soon as possible after installing the spare tire. Adjust it to the specified pressure, if necessary. Refer to "Tires and wheels" on page 8-6.

Wheel nut tightening torque:

79~94 lbf·ft (11~13 kgf·m)

If you have a tire gauge, remove the valve cap and check the air pressure. If the pressure is lower than recommended, drive slowly to the nearest service station and inflate to the correct pressure. If it is too high,

adjust it until it is correct. Always reinstall the valve cap after checking or adjusting the tire pressure. If the cap is not replaced, dust and dirt may get into the tire valve and air may leak from the tire. If you lose a valve cap, buy another and install it as soon as possible.

After you have changed the wheels, always secure the flat tire in its place and return the jack and tools to their proper storage locations.

CAUTION

Reusing lug nuts

Make certain during wheel removal that the same nuts that were removed are reinstalled – or, if replaced, that nuts with metric threads and the same chamfer configuration are used. Your vehicle has metric threads on the wheel studs and nuts. Installation of a non-metric thread nut on a metric stud will not secure the wheel to the hub properly and will damage the stud so that it must be replaced.

Note that most lug nuts do not have metric threads. Be sure to use extreme care in checking for thread style before installing aftermarket lug nuts or wheels. If in doubt, consult an authorized Kia dealer.

⚠ WARNING**Wheel studs**

If the studs are damaged, they may lose their ability to retain the wheel. This could lead to the loss of the wheel and a collision resulting in serious injuries.

⚠ WARNING

Never use oil or grease on bolts or nuts because the nuts might come loose. The vehicle's wheel could fall off, causing a crash.

Important - use of compact spare tire

Your vehicle is equipped with a compact spare tire. This compact spare tire takes up less space than a regular-size tire. This tire is smaller than a conventional tire and is designed for temporary use only.

- You should drive carefully when the compact spare is in use. The compact spare should be replaced by the proper conventional tire and rim at the first opportunity.
- The operation of this vehicle is not recommended with more than one compact spare tire in use at the same time.

⚠ WARNING**Spare tire**

The compact spare tire is for emergency use only. Do not operate your vehicle on this compact spare at speeds over 50 mph (80 km/h). The original tire should be repaired or replaced as soon as possible to avoid failure of the spare, possibly leading to bodily injury or death.

The compact spare should be inflated to 60 psi (420 kPa).

*** NOTICE**

Check the inflation pressure after installing the spare tire. Adjust it to the specified pressure, as necessary.

When using a compact spare tire, observe the following precautions:

- Under no circumstances should you exceed 50 mph (80 km/h); a higher speed could damage the tire.
- Ensure that you drive slowly enough for the road conditions to avoid all hazards. Any road hazard, such as a pothole or debris, could seriously damage the compact spare.

- Any continuous road use of this tire could result in tire failure, loss of vehicle control, and possible personal injury.
- Do not exceed the vehicle's maximum load rating or the load-carrying capacity shown on the sidewall of the compact spare tire.
- Avoid driving over obstacles. The compact spare tire diameter is smaller than the diameter of a conventional tire and reduces the ground clearance approximately 1 inch (25 mm), which could result in damage to the vehicle.
- Do not take this vehicle through an automatic vehicle wash while the compact spare tire is installed.
- Do not use tire chains on the compact spare tire. Because of the smaller size, a tire chain will not fit properly. This could damage the vehicle and result in loss of the chain.
- Do not use the compact spare tire on any other vehicle because this tire has been designed especially for your vehicle.
- The compact spare tire's tread life is shorter than a regular tire. Inspect your compact spare tire regularly and replace worn compact spare tires with the same size and design, mounted on the same wheel.
- The compact spare tire should not be used on any other wheels, nor should standard tires, snow tires, wheel covers or trim rings be used with the compact spare wheel. If such use is attempted, damage to these items or other vehicle components may occur.
- Do not use more than one compact spare tire at a time.
- Do not tow a trailer while the compact spare tire is installed.
- Do not suddenly accelerate or decelerate (0 ↔ 25 mph) (0 ↔ 40 km/h) in any driving mode. It may cause leakage of transfer oil.

Jack label (if equipped)

Type A

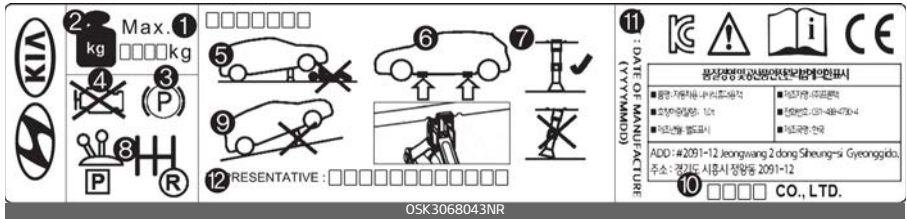

Type B

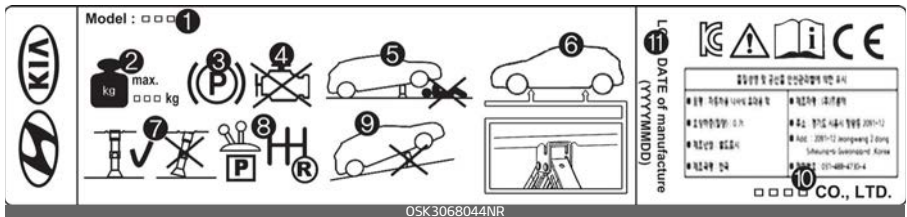

Type C



* The actual jack label in the vehicle may differ from the illustration. For more detailed specifications, refer to the label attached to the jack.

1. Model Name
2. Maximum allowable load
3. When using the jack, set your parking brake.
4. When using the jack, stop the engine.
5. Do not get under a vehicle that is supported by a jack.
6. The designated locations under the frame
7. When supporting the vehicle, the base plate of jack must be vertical under the lifting point.
8. Move the shift lever to the P position on vehicles with intelligent variable transmission.
9. The jack should be used on firm level ground.
10. Jack manufacturer
11. Production date
12. Representative company and address

Towing

If emergency towing is necessary, have it done by an authorized Kia dealer or a commercial tow-truck service.

Towing service

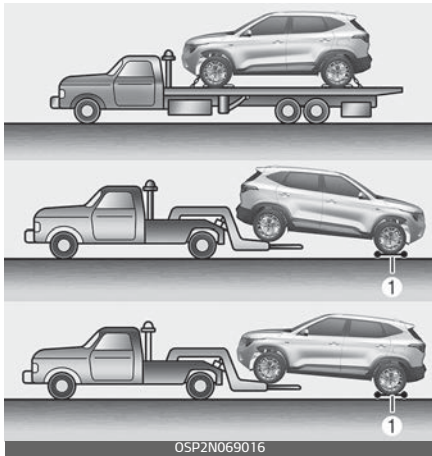

1. dollies

Proper lifting and towing procedures are necessary to prevent damage to the vehicle. The use of wheel dollies (1) or flatbed is recommended.

On Front Wheel Drive (FWD) vehicles, it is acceptable to tow the vehicle with the rear wheel on the ground (without dollies) and the front wheels off the ground. If any of the loaded wheels or suspension components are damaged or the vehicle is being towed with the front wheels on the ground, use a towing

dolly under the front wheels. When being towed by a commercial tow truck and wheel dollies are not used, the front of the vehicle should always be lifted, not the rear.

On All Wheel Drive (AWD) vehicles, your vehicle must be towed with a wheel lift and dollies or flatbed equipment with all the wheels off the ground.

CAUTION

An AWD vehicle should never be towed with the wheels on the ground. This can cause serious damage to the transaxle or the AWD system.

WARNING

Side and curtain Air bag

If your vehicle is equipped with side and curtain air bag, set the ENGINE START/STOP button to ACC position when the vehicle is being towed.

The side and curtain air bag may deploy when the ENGINE START/STOP button to ON position and the rollover sensor detects the situation as a rollover.

*** NOTICE**

If the EPB does not release normally, take your vehicle to an authorized Kia dealer by loading the vehicle on a flatbed tow truck and have the system checked.

⚠ CAUTION

Towing



- Do not tow the vehicle backwards with the front wheels on the ground, as this may cause damage to the transmission.
- Do not tow with sling-type equipment. Use wheel lift or flatbed equipment.

⚠ WARNING

- If you tow the vehicle while the front wheels are touching the ground, the vehicle motor may generate electricity and the motor components may be damaged or a fire may occur.
- When a vehicle fire occurs due to the battery, there is a risk of a second fire. Contact the fire department when towing the vehicle.

Towing without wheel dollies when using a towing service

When towing your vehicle in an emergency without wheel dollies:

1. Set the ENGINE START/STOP button to ACC position.
2. Place the transmission shift lever in N (Neutral).
3. Release the parking brake.

⚠ CAUTION

Towing gear position

Failure to shift to N (Neutral) may cause internal damage to the vehicle.

Using removable towing hook (if equipped)



Front

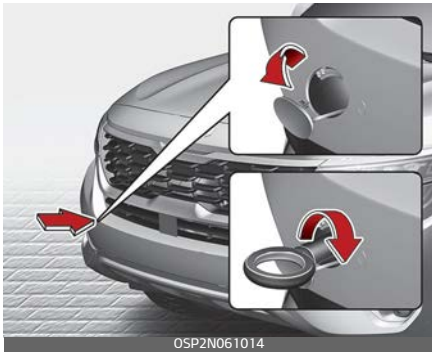

Rear



1. Open the liftgate, and remove the towing hook from the tool case.

2. Remove the hole cover pressing the lower part of the cover on the bumper.
3. Install the towing hook by turning it clockwise into the hole until it is fully secured.
4. Remove the towing hook and install the cover after use.

Emergency towing

If towing service is not available in an emergency, your vehicle may be temporarily towed using a cable or chain secured to the emergency towing hook under the front (or rear) of the vehicle.

Front





If towing is necessary, have it done by an authorized Kia dealer or a commercial tow truck service.

Use extreme caution when towing the vehicle. A driver must be in the vehicle to steer it and operate the brakes.

Towing in this manner may be done only on hard-surfaced roads for a short distance and at a low speed. Also, the wheels, axles, power train, steering and brakes must all be in good condition.

- Do not use the tow hooks to pull a vehicle out of mud, sand or other conditions from which the vehicle cannot be driven out under its own power.
- Avoid towing a vehicle heavier than the vehicle doing the towing.
- The drivers of both vehicles should communicate with each other frequently.

⚠ CAUTION

Using a portion of the vehicle other than the tow hooks for towing may damage the body of your vehicle.

- Accelerate or decelerate the vehicle in a slow and gradual manner while maintaining tension on the tow rope or chain to start or drive the vehicle. Otherwise tow hooks and the vehicle may be damaged.
- Attach a towing strap to the tow hook.
- Use only a cable or chain specifically intended for use in towing vehicles. Securely fasten the cable or chain to the towing hook provided.
- Before emergency towing, check if the hook is not broken or damaged.
- Fasten the towing cable or chain securely to the hook.
- Do not jerk the hook. Apply it steadily and with even force.
- To avoid damaging the hook, do not pull from the side or at a vertical angle. Always pull straight ahead.
- Use a towing strap less than 16 ft (5 m) long. Attach a white or red cloth (about 12 in (30 cm) wide) in the middle of the strap for easy visibility.

Front

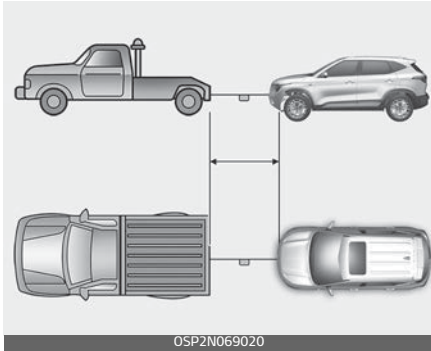

Rear

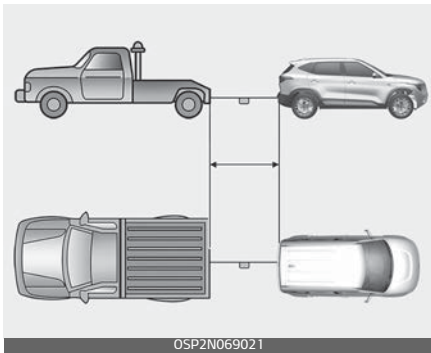

- Drive carefully so that the towing strap is not loosened during towing.
- The driver must be in the vehicle for steering and braking operations when the vehicle is towed and passengers other than the driver must not be allowed to be on board.

⚠ WARNING

Emergency Towing Precautions

Use extreme caution when towing the vehicle.

- Avoid sudden starts or erratic driving maneuvers which would place excessive stress on the emergency towing hook and towing cable or chain. The hook and towing cable or chain may break and cause serious injury or damage.
- If the disabled vehicle is unable to be moved, do not forcibly continue the towing. Contact an authorized Kia dealer or a commercial tow truck service for assistance.
- Tow the vehicle as straight ahead as possible.
- Keep away from the vehicle during towing.

Emergency towing precautions

1. Turn the ignition switch to ACC so the steering wheel isn't locked.
2. Release the parking brake.
3. Press the brake pedal with more force than normal since you will have reduced brake performance.
4. More steering effort will be required because the power steering system will be disabled.

5. If you are driving down a long hill, the brakes may overheat and brake performance will be reduced. Stop often and let the brakes cool off.
6. If the car is being towed with all four wheels on the ground, it can be towed only from the front. Be sure that the reduction gear is in neutral. Be sure the steering is unlocked by the ignition switch in the ACC position. A driver must be in the towed vehicle to operate the steering and brakes.
7. To avoid serious damage to the Dual clutch transmission and Intelligent Variable Transmission, limit the vehicle speed to 15 km/h (10 mph) and drive less than 1.5 km (1 mile) when towing.

⚠ CAUTION

Intelligent Variable Transmission (IVT)

Vehicles with Intelligent Variable Transmission (IVT) can only be towed to an ordinary vehicle when there is no IVT transmission oil leakage. If towing to an ordinary vehicle in the event of oil leakage, the transmission may be damaged. If towing to an ordinary vehicle in the event of oil leakage, the transmission may be damaged.

⚠ CAUTION

Dual clutch transmission / Intelligent Variable Transmission

- If the car is being towed with all four wheels on the ground, it can be towed only from the front. Be sure that the transmission is in neutral. Be sure the steering is unlocked by placing the ignition switch in the ACC position. A driver must be in the towed vehicle to operate the steering and brakes.
- Before towing, check the Intelligent Variable Transmission for fluid leaks under your vehicle. If the Intelligent Variable Transmission fluid is leaking, flatbed equipment or a towing dolly must be used.

Engine compartment	7-4
Maintenance services	7-6
Owner maintenance	7-8
Scheduled maintenance service	7-10
Explanation of scheduled maintenance items	7-20
Engine oil and filter	7-24
• Checking the engine oil level.....	7-24
• Changing the engine oil and filter	7-26
Engine coolant	7-27
• Checking the coolant level.....	7-29
• Changing the coolant	7-30
Brake fluid	7-30
• Checking the brake fluid level.....	7-30
Washer fluid	7-31
• Checking the washer fluid level.....	7-31
Parking brake	7-32
• Checking the parking brake	7-32
Air cleaner filter	7-33
• Replacing air cleaner filter	7-33
Climate control air filter	7-34
• Inspecting and replacing climate control air filter	7-34
Wiper blades	7-36
• Front windshield wiper blade	7-36
• Replacing front windshield wiper blade.....	7-37
• Replacing rear window wiper blade.....	7-38
Battery	7-39
Tires and wheels	7-42

7 Maintenance

- Checking tire inflation pressure 7-43
- Tire rotation 7-44
- Wheel alignment and tire balance 7-44
- Tire replacement 7-45
- Wheel replacement 7-45
- Tire traction..... 7-46
- Tire maintenance..... 7-46
- Tire sidewall labeling 7-46
- Tire terminology and definitions 7-49
- All season tires 7-52
- Summer tires 7-52
- Snow tires 7-52
- Tire chains..... 7-53
- Radial-ply tires..... 7-53
- Low aspect ratio tire 7-54
- Fuses 7-55**
- Replacing inner panel fuse 7-57
- Replacing engine compartment fuse 7-58
- Fuse/relay panel description 7-60
- Light bulbs 7-68**
- Headlamp bulb 7-72
- Replacing headlamp (low/high) / turn signal lamp / position lamp (bulb type) (headlamp type A)..... 7-73
- Replacing headlamp (low/high) / turn signal lamp bulb (bulb type) (headlamp type B) 7-73
- Replacing position lamp / daytime running lamp (LED type) (headlamp type B) 7-74
- Replacing headlamp (high and low) / position lamp / daytime running lamp / turn signal lamp (LED type) (headlamp type C) 7-75

- Replacing position lamp (auxiliary) (LED type)..... 7-75
- Replacing front fog lamp (bulb/LED type) 7-76
- Replacing side repeater lamp (LED type)..... 7-76
- Replacing side repeater lamp bulb (bulb type)..... 7-77
- Replacing front side marker lamp bulb (bulb type)..... 7-77
- Replacing front side marker lamp bulb (LED type) 7-78
- Replacing rear turn signal lamp / back up lamp bulb / tail lamp / tail and stop lamp bulb / side marker lamp bulb (bulb type) (rear combination lamp type A, B)..... 7-78
- Replacing stop lamp / tail and stop lamp & Side marker lamp (LED type) (rear combination lamp type B) 7-79
- Replacing High Mounted Stop Lamp bulb (LED type)..... 7-79
- Replacing license plate lamp bulb 7-79
- Replacing map lamp (bulb/LED type) bulb 7-80
- Replacing vanity mirror lamp bulb 7-80
- Replacing room lamp (bulb type) bulb 7-81
- Replacing room lamp (LED type) bulb..... 7-81
- Replacing glove box lamp 7-82
- Replacing luggage room lamp (bulb type) bulb 7-82
- Appearance care 7-83**
- Exterior care..... 7-83
- Interior care..... 7-88
- Emission control system 7-91**
- California perchlorate notice 7-94**

MAINTENANCE

Engine compartment

Open the hood to see the engine compartment.

(Gasoline) 1.6 T-GDi

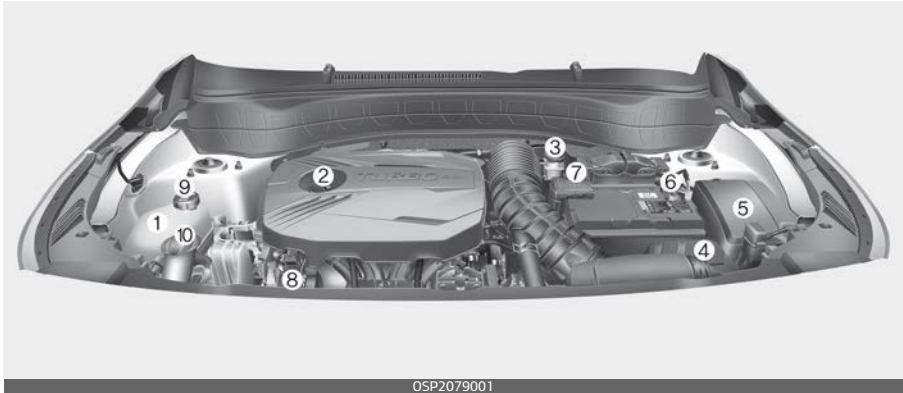

OSP2079001

* The actual engine room in the vehicle may differ from the illustration.

1. Engine coolant reservoir
2. Engine oil filler cap
3. Brake fluid reservoir
4. Air cleaner
5. Fuse box
6. Negative battery terminal
7. Positive battery terminal
8. Engine oil dipstick
9. Radiator cap
10. Windshield washer fluid reservoir

(Gasoline) 2.0 MPI

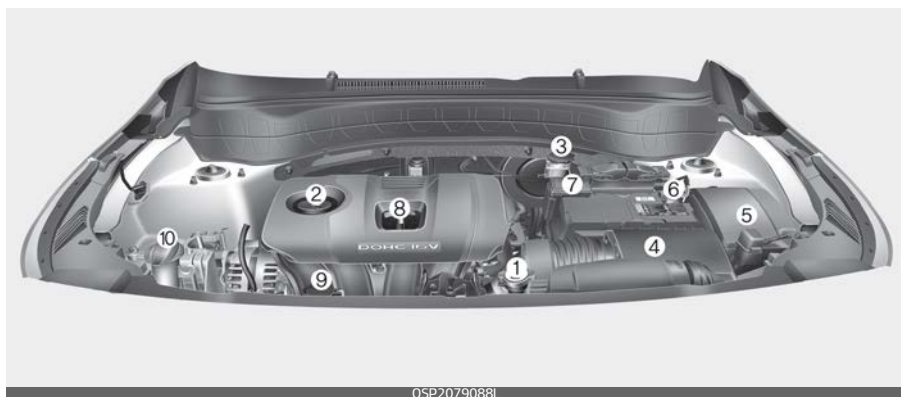

* The actual engine room in the vehicle may differ from the illustration.

1. Radiator cap
2. Engine oil filler cap
3. Brake fluid reservoir
4. Air cleaner
5. Fuse box
6. Negative battery terminal
7. Positive battery terminal
8. Engine oil dipstick
9. Engine coolant reservoir
10. Windshield washer fluid reservoir

Maintenance services

You should exercise the utmost care to prevent damage to your vehicle and injury to yourself whenever performing any maintenance or inspection procedures.

Should you have any doubts concerning the inspection or servicing of your vehicle, have an authorized Kia dealer perform this work.

An authorized Kia dealer has factory-trained technicians and genuine Kia parts to service your vehicle properly. For expert advice and quality service, see an authorized Kia dealer.

Inadequate, incomplete or insufficient servicing may result in operational problems with your vehicle that could lead to vehicle damage, an accident, or personal injury.

Owner's responsibility

* NOTICE

Maintenance Service and Record Retention are the owner's responsibility.

You should retain documents that show proper maintenance has been performed on your vehicle in accordance with the scheduled maintenance service charts shown on the following pages. You need this information to establish your com-

pliance with the servicing and maintenance requirements of your vehicle warranties.

Detailed warranty information is provided in your Warranty & Consumer Information manual.

Repairs and adjustments required as a result of improper maintenance or a lack of required maintenance are not covered.

Have your vehicle maintained and repaired by an authorized Kia dealer. Authorized Kia dealers meet Kia's high service quality standards and receive technical support from Kia in order to provide you with a high level of service satisfaction.

* NOTICE

NHTSA Safety Corrosion Alert

The National Highway Traffic Safety Administration (NHTSA) has issued a general warning to all vehicle owners of all brands regarding the risks associated with vehicle underbody corrosion. From your initial purchase, take the following steps to prevent unsafe corrosion damage to your vehicle:

- Wash the undercarriage of your vehicle regularly during the winter and whenever your vehicle has been exposed to such salts or chemicals.

- Do a thorough washing of the undercarriage at the end of the winter.
- Use professional service technicians or governmental inspection stations to annually inspect for corrosion.
- Immediately seek an inspection of your vehicle if you become visually aware of corrosion flaking or scaling or if you become aware of a change in vehicle performance, such as soft or spongy brakes, fluids leaking, impairment of directional control, suspension noises or rattling metal straps.
- NHTSA further advises that after a vehicle is 7 years old, it is essential that you take these indicated maintenance steps to ensure that you protect yourself from unsafe corrosion conditions.

Owner maintenance precautions

Improper or incomplete service may result in problems. This section gives instructions only for the maintenance items that are easy to perform.

As explained earlier in this section, several procedures can be done only by an authorized Kia dealer with special tools.

* NOTICE

Improper owner maintenance during the warranty period may affect warranty coverage. For details, read the separate Warranty & Consumer Information manual provided with the vehicle. If you're unsure about any servicing or maintenance procedure, have it done by an authorized Kia dealer.

⚠ WARNING

Maintenance work

Do not wear jewelry or loose clothing while working under the hood of your vehicle with the engine running. These items can become entangled in moving parts. If you must run the vehicle in the engine while working under the hood, make certain that you remove all jewelry (especially rings, bracelets, watches, and necklaces) and all neckties, scarves, and similar loose clothing before getting near cooling fans.

⚠ WARNING**Touching metal parts**

Do not touch metal parts (including strut bars) while the vehicle is operating or hot. Doing so could result in serious bodily injury. Turn the vehicle off and wait until the metal parts cool down to perform maintenance work on the vehicle.

Owner maintenance

The following lists are vehicle checks and inspections that should be performed by the owner or an authorized Kia dealer at the frequencies indicated to help ensure safe, dependable operation of your vehicle.

Any adverse conditions should be brought to the attention of your dealer as soon as possible.

These owner maintenance checks are generally not covered by warranties and you may be charged for labor, parts and lubricants used.

When you stop for fuel:

- Check the coolant level in coolant reservoir.
- Check the windshield washer fluid level.
- Look for low or under-inflated tires.
- Check if the front of the radiator and condenser are clean and not blocked with leaves, dirt or insects etc. If any of the above parts are extremely dirty or you are not sure of their condition, take your vehicle to an authorized Kia dealer.

WARNING

Hot coolant

Be careful when checking your engine coolant level when the engine is hot. Scalding hot coolant and steam may blow out under pressure.

While operating your vehicle:

- Note any changes in the sound of the exhaust or any smell of exhaust fumes in the vehicle.
- Check for vibrations in the steering wheel. Notice any increased steering effort or looseness in the steering wheel, or change in its straight-ahead position.
- Notice if your vehicle constantly turns slightly or "pulls" to one side when traveling on smooth, level road.
- When stopping, listen and check for unusual sounds, pulling to one side, increased brake pedal travel or "hard-to-push" brake pedal.
- If any slipping or changes in the operation of your transmission occurs, take your vehicle to an authorized Kia dealer.
- Check the Intelligent Variable Transmission (IVT) P (Park) function.
- Check the parking brake.
- Check for fluid leaks under your vehicle (water dripping from the

air conditioning system during or after use is normal).

At least monthly:

- Check the coolant level in the coolant reservoir.
- Check the operation of all exterior lights, including the stoplights, turn signals and hazard warning flashers.
- Check the inflation pressures of all tires including the spare for tires that are worn, show uneven wear, or are damaged.
- Check for loose wheel lug nuts.

At least once every 6 months :

- Check the radiator, heater and air conditioning hoses for leaks or damage.
- Check the windshield washer spray and wiper operation. Clean the wiper blades with clean cloth dampened with washer fluid.
- Check the headlight alignment.
- Check the muffler, exhaust pipes, shields and clamps.
- Check the lap/shoulder belts for wear and function.

At least once a year:

- Clean the body and door drain holes.
- Lubricate the door hinges and check the hood hinges.
- Lubricate the door and hood locks and latches.
- Lubricate the door rubber weatherstrips.
- Check the air conditioning system.
- Inspect and lubricate Intelligent Variable Transmission (IVT) linkage and controls.
- Clean the battery and terminals.
- Check the brake fluid level.
- Visually inspect steering, suspension, and chassis components for damaged, loose, or missing parts or signs of wear.

Scheduled maintenance service

Follow the Normal Maintenance Schedule if the vehicle is usually operated where none of the following conditions apply.

Follow the Maintenance Under Severe Usage Conditions if any of the following conditions apply.

- Repeated driving short distance of less than 5 miles (8 km) in normal temperature or less than 10 miles (16 km) in freezing temperature.
- Extensive engine idling or low speed driving for long distances.
- Driving on rough, dusty, muddy, unpaved, graveled or salt-spread roads.
- Driving in areas using salt or other corrosive materials or in very cold weather.
- Driving in heavy dust condition.
- Driving in heavy traffic area.
- Driving on uphill, downhill, or mountain road repeatedly.
- Using for towing or camping, and driving with loading on the roof.
- Driving as a patrol car, taxi, other commercial use of vehicle towing.
- Frequently driving under high speed or rapid acceleration/deceleration.
- Frequently driving in stop-and-go condition.

*** NOTICE**

After 10 years or 100,000 miles, we recommend to use severe maintenance schedule.

Normal maintenance schedule – Non Turbo Models

The following maintenance services must be performed to ensure good emission control and performance. Keep receipts for all vehicle services to protect your warranty. Where both mileage and date are shown, the frequency of service is determined by whichever occurs first.

I: Inspect and if necessary, adjust, correct, clean or replace.

R: Replace or change

Number of months or driving distance, whichever comes first															
Months	12	24	36	48	60	72	84	96	108	120	132	144	156	168	180
Miles×1,000	7.5	15	22.5	30	37.5	45	52.5	60	67.5	75	82.5	90	97.5	105	112.5
Km×1,000	12	24	36	48	60	72	84	96	108	120	132	144	156	168	180
Rotate tires	Rotate every 7,500 miles (12,000 km)														
Engine oil and engine oil filter*1	(Gasoline) 2.0 MPI	R	R	R	R	R	R	R	R	R	R	R	R	R	R
Climate control air filter		I	R	I	R	I	R	I	R	I	R	I	R	I	R
Air cleaner filter		I	I	I	R	I	I	I	R	I	I	I	R	I	I
Brake fluid	Inspect every 7,500 miles (12,000 km) or 12 months, Replace every 60,000 miles (96,000 km) or 48 months														
Spark plugs	Replace every 97,500 miles (156,000 km)														
Coolant (Engine)	At first, replace at 120,000 miles (192,000 km) or 10 years, after that, replace every 30,000 miles (48,000 km) or 24 months														
Vacuum hose															
Air conditioner refrigerant															
Exhaust system															
Brake lines, hoses and connections															
Parking brake															
Brake discs and pads															
Suspension ball joints and mounting bolts	I	I	I	I	I	I	I	I	I	I	I	I	I	I	I
Steering gear rack, linkage and boots															
Air conditioner compressor															
Drive shaft and boots															
Fuel lines, hoses and connections															
Fuel tank and fuel cap	-	I	-	I	-	I	-	I	-	I	-	I	-	I	-
Fuel tank air filter															

Number of months or driving distance, whichever comes first															
Months	12	24	36	48	60	72	84	96	108	120	132	144	156	168	180
Miles×1,000	7.5	15	22.5	30	37.5	45	52.5	60	67.5	75	82.5	90	97.5	105	112.5
Km×1,000	12	24	36	48	60	72	84	96	108	120	132	144	156	168	180
Cooling system	-	-	-		-		-		-		-		-		-
Rear differential oil (4WD) ^{*2}	Inspect every 37,500 miles (60,000 km) or 48 months														
Transfer case oil (4WD) ^{*3}															
Drive belts ^{*4}	At first, inspect at 60,000 miles (96,000 km) or 72 months, after that, inspect every 15,000 miles (24,000 km) or 24 months														
Intelligent Variable Transmission (IVT) fluid	No service required														

- * 1. Engine oil and engine oil filter : As it is normal for engine oil to be consumed during driving, the engine oil level should be checked on regular basis.
The engine oil change interval for normal operating conditions is based on the use of the recommended engine specification. If the recommended engine oil specification is not used, then replace the engine oil according to the maintenance schedule under severe operating conditions.
- * 2. Rear differential oil (4WD) : If the vehicle has been submerged in water or in a flooded area, the fluids should be changed as a precaution.
- * 3. Transfer case oil (4WD) : If the vehicle has been submerged in water or in a flooded area, the fluids should be changed as a precaution.
- * 4. Drive belts (Engine) : Inspect alternator, water pump and air conditioner drive belt and if necessary, repair or replace. Inspect drive belt tensioner, idler and alternator pulley and if necessary correct or replace.
- Fuel filter (gasoline engine): The fuel filter is considered to be maintenance free but periodic inspection is recommended for this maintenance schedule depends on fuel quality.
 - If there are some important safety matters like fuel flow restriction, surging, loss of power, hard starting problem etc, replace the fuel filter immediately regardless of maintenance schedule and consult an authorized Kia dealer for details.

Maintenance Under Severe Usage Conditions - Non Turbo Models

The following items must be serviced more frequently on cars mainly used under severe driving conditions. Refer to the chart below for the appropriate maintenance intervals.

R: Replace

I: Inspect and if necessary, adjust, correct, clean or replace

Maintenance item		Maintenance operation	Maintenance intervals	Driving condition
Engine oil and engine oil filter	(Gasoline) 2.0 MPI	R	Every 3,750 miles (6,000 km) or 6 months	A, B, C, D, E, F, G, H, I, J, K
Intelligent Variable Transmission (IVT) fluid		R	Every 60,000 miles (96,000 km)	A, C, E, F, G, H, I, K
Rear differential oil (4WD) (if equipped)		R	Every 80,000 miles (120,000 km)	C, D, E, G, H, I, J
Transfer case oil (4WD) (if equipped)		R	Every 80,000 miles (120,000 km)	C, D, E, G, H, I, J
Air cleaner filter		R	More frequently	C, E
Spark plugs		R	More frequently	A, B, F, G, H, I, K
Climate control air filter		I	More frequently	C, E, G
Parking brake		I	More frequently	C, D, G, H
Brake discs, pads and calipers		I	More frequently	C, D, E, G, H
Suspension ball joints and mounting bolts		I	More frequently	C, D, E, F, G
Steering gear rack, linkage and boots		I	More frequently	C, D, E, F, G
Drive shafts and boots		I	More frequently	C, D, E, F, G, H, I, J

Severe Driving Conditions

A: Repeatedly driving short distance of less than 5 miles (8 km) in normal temperature or less than 10 miles (16 km) in freezing temperature.

B: Extensive low speed driving for long distances.

C: Driving on rough, dusty, muddy, unpaved, graveled or salt-spread roads.

D: Driving in areas using salt or other corrosive materials or in very cold weather.

E: Driving in heavy dust condition.

F: Driving in heavy traffic area.

G: Driving on uphill, downhill, or mountain roads.

H: Using for towing or camping, and driving with loading on the roof.

I: Driving for patrol car, taxi, commercial car or vehicle towing.

J: Frequently driving under high speed or rapid acceleration/deceleration.

K: Frequently driving in stop-and-go conditions

* NOTICE

After 10 years or 100,000 miles, we recommend to use severe maintenance schedule.

Normal maintenance schedule – Turbo Models

The following maintenance services must be performed to ensure good emission control and performance. Keep receipts for all vehicle services to protect your warranty. Where both mileage and date are shown, the frequency of service is determined by whichever occurs first.

I: Inspect and if necessary, adjust, correct, clean or replace.

R: Replace or change

		Number of months or driving distance, whichever comes first															
Months		12	24	36	48	60	72	84	96	108	120	132	144	156	168	180	
Miles×1,000		6	12	18	24	30	36	42	48	54	60	66	72	78	84	90	
Km×1,000		10	20	30	40	50	60	70	80	90	100	110	120	130	140	150	
Rotate tires		Rotate every 6,000 miles (10,000 km)															
Fuel additives *1	(Gasoline) 1.6 T-GDi	Add every 6,000 miles (10,000 km) or 12 months															
Engine oil and engine oil filter *2	(Gasoline) 1.6 T-GDi	R	R	R	R	R	R	R	R	R	R	R	R	R	R	R	
Climate control air filter		Replace every 15,000 miles (24,000 km) or 24 months															
Air cleaner filter		I	I	I	R	I	I	I	R	I	I	I	R	I	I	I	
Spark plugs		Replace every 42,000 miles (70,000 km)															
Brake fluid		Inspect every 6,000 miles (10,000 km) or 12 months, Replace every 48,000 miles (80,000 km) or 48 months															
Coolant (Engine)		At first, replace at 120,000 miles (192,000 km) or 10 years, after that, replace every 30,000 miles (48,000 km) or 24 months															

Number of months or driving distance, whichever comes first																
Months		12	24	36	48	60	72	84	96	108	120	132	144	156	168	180
Miles×1,000		6	12	18	24	30	36	42	48	54	60	66	72	78	84	90
Km×1,000		10	20	30	40	50	60	70	80	90	100	110	120	130	140	150
Intercooler, in/out hose, air intake hose	(Gasoline) 1.6 T-GDi															
Cooling system																
Vacuum hose																
Air conditioner refrigerant																
Exhaust system																
Brake lines, hoses and connections																
Parking brake																
Brake discs and pads																
Suspension ball joints and mounting bolts																
Steering gear rack, linkage and boots																
Air conditioner compressor																
Drive shaft and boots																
Fuel lines, hoses and connections																
Fuel tank and fuel cap		-		-		-		-		-		-		-		-
Fuel tank air filter																
Dual clutch transmission fluid		Inspection every 40,000 miles (60,000 km) or 48 months														
Transfer case oil (4WD) ^{*3}		Inspect every 37,500 miles (60,000 km) or 48 months														
Rear differential oil (4WD) ^{*4}																
Drive belts ^{*5}		At first, inspect at 60,000 miles (100,000 km) or 72 months, after that, inspect every 18,000 miles (30,000 km) or 24 months														
Valve clearance ^{*6}		(Gasoline) 1.6 T-GDi Inspect every 60,000 miles (100,000 km) or 72 months														

* 1. Fuel additives : Kia recommends that you use Tier 1 unleaded gasoline fuel having a pump octane number ((R+M)/2) of 87 (Research Octane Number 91) or higher. For customers who do not use good quality gasolines including fuel additives regularly, and have problems starting or the engine does not run smoothly, one bottle of additives should be added to the fuel tank at every 6,000 miles (10,000 km). Additives are available from an authorized Kia dealer. Do not mix with other additives.

- * 2. Engine oil and engine oil filter : As it is normal for engine oil to be consumed during driving, the engine oil level should be checked on regular basis. The engine oil change interval for normal operating conditions is based on the use of the recommended engine specification. If the recommended engine oil specification is not used, then replace the engine oil according to the maintenance schedule under severe operating conditions.
- * 3. Transfer case oil (4WD) : If the vehicle has been submerged in water or in a flooded area, the fluids should be changed as a precaution.
- * 4. Rear differential oil (4WD) : If the vehicle has been submerged in water or in a flooded area, the fluids should be changed as a precaution.
- * 5. Drive belts (Engine) : Inspect alternator, water pump and air conditioner drive belt and if necessary, repair or replace. Inspect drive belt tensioner, idler and alternator pulley and if necessary correct or replace.
- * 6. Valve clearance : Inspect for excessive valve noise and/or engine vibration and adjust if necessary. Have an authorized Kia dealer perform the operation
- Fuel filter (gasoline engine): The fuel filter is considered to be maintenance free but periodic inspection is recommended for this maintenance schedule depends on fuel quality.
 - If there are some important safety matters like fuel flow restriction, surging, loss of power, hard starting problem etc, replace the fuel filter immediately regardless of maintenance schedule and consult an authorized Kia dealer for details.

Maintenance Under Severe Usage Conditions – Turbo Models

The following items must be serviced more frequently on cars mainly used under severe driving conditions. Refer to the chart below for the appropriate maintenance intervals.

R: Replace

I: Inspect and if necessary, adjust, correct, clean or replace

Maintenance item		Maintenance operation	Maintenance intervals	Driving condition
Engine oil and engine oil filter	(Gasoline) 1.6 T-GDi	R	Every 3,000 miles (5,000 km) or 6 months	A, B, C, D, E, F, G, H, I, J, K
Dual clutch transmission fluid		R	Every 80,000 miles (120,000 km)	C, D, E, F, G, H, I, J
Rear differential oil (4WD) (if equipped)		R	Every 80,000 miles (120,000 km)	C, D, E, G, H, I, J
Transfer case oil (4WD) (if equipped)		R	Every 80,000 miles (120,000 km)	C, D, E, G, H, I, J
Climate control air filter		R	More frequently	C, E, G
Air cleaner filter		R	More frequently	C, E
Spark plugs		R	More frequently	A, B, F, G, H, I, K
Parking brake		I	More frequently	C, D, G, H
Brake discs, pads and calipers		I	More frequently	C, D, E, G, H
Suspension ball joints and mounting bolts		I	More frequently	C, D, E, F, G
Steering gear rack, linkage and boots		I	More frequently	C, D, E, F, G
Drive shafts and boots		I	More frequently	C, D, E, F, G, H, I, J

Severe Driving Conditions

A: Repeatedly driving short distance of less than 5 miles (8 km) in normal temperature or less than 10 miles (16 km) in freezing temperature.

B: Extensive low speed driving for long distances.

C: Driving on rough, dusty, muddy, unpaved, graveled or salt-spread roads.

D: Driving in areas using salt or other corrosive materials or in very cold weather.

E: Driving in heavy dust condition.

F: Driving in heavy traffic area.

G: Driving on uphill, downhill, or mountain roads.

H: Using for towing or camping, and driving with loading on the roof.

I: Driving for patrol car, taxi, commercial car or vehicle towing.

J: Frequently driving under high speed or rapid acceleration/deceleration.

K: Frequently driving in stop-and-go conditions

* NOTICE

After 10 years or 100,000 miles, we recommend to use severe maintenance schedule.

Explanation of scheduled maintenance items

The following parts require scheduled maintenance.

Engine oil and filter

The engine oil and filter should be changed at the intervals specified in the maintenance schedule. If the vehicle is being driven in severe conditions, more frequent oil and filter changes are required.

Drive belts

Inspect all drive belts for evidence of cuts, cracks, excessive wear or oil saturation and replace if necessary. Drive belts should be checked periodically for proper tension and adjusted as necessary.

Fuel filter

Kia gasoline vehicle is equipped with a lifetime fuel filter that is integrated with the fuel tank. Regular maintenance or replacement is generally not needed. This may vary depending on fuel quality. If you experience any of the following: fuel flow restriction, surging, loss of power, or a hard starting issue, inspection and, if necessary, replacement may be needed. Have the fuel filter inspected or replaced by an authorized Kia dealer.

Fuel lines, fuel hoses and connections

Check the fuel lines, fuel hoses and connections for leakage and damage. Have an authorized Kia dealer replace any damaged or leaking parts immediately.

Fuel tank and fuel cap

The fuel tank and fuel cap should be inspected at those intervals specified in the maintenance schedule. Make sure that a new fuel tank and fuel cap is correctly replaced.

Vacuum crankcase ventilation hoses

Inspect the surface of hoses for evidence of heat and/or mechanical damage. Hard and brittle rubber, cracking, tears, cuts, abrasions, and excessive swelling indicate deterioration. Particular attention should be paid to examine those hose surfaces nearest to high heat sources, such as the exhaust manifold. Inspect the hose routing to assure that the hoses do not come in contact with any heat source, sharp edges or moving components which might cause heat damage or mechanical wear. Inspect all hose connections, such as clamps and couplings, to make sure they are secure, and that no leaks are present. Hoses should be replaced immediately if there is any evidence of deterioration or damage.

Air cleaner filter

A Genuine Kia air cleaner filter is recommended when the filter is replaced.

Spark plugs

Make sure to install new spark plugs of the correct heat range.

When assembling parts, be sure to wipe the inside and outside of the boot bottom of the ignition coil and the insulator of the spark plug with a soft cloth to prevent contamination of the spark plug insulator.

Valve clearance (if equipped)

Inspect for excessive valve noise and/or engine vibration and adjust if necessary. An authorized Kia dealer should perform the operation.

Cooling system

Check the cooling system components, such as the radiator, coolant reservoir, hoses and connections for leakage and damage. Replace any damaged parts.

Coolant

The coolant should be changed at the intervals specified in the maintenance schedule.

Intelligent Variable Transmission (IVT) fluid (if equipped)

Intelligent Variable Transmission (IVT) fluid should not be checked under normal usage conditions. But

in severe conditions, the fluid should be changed at an authorized Kia dealer in accordance to the scheduled maintenance at the beginning of this section.

* NOTICE

Intelligent Variable Transmission (IVT) fluid color is usually light amber. As the vehicle is driven, the Intelligent Variable Transmission (IVT) fluid will begin to look darker. This is a normal condition and you should not feel the need to replace the fluid based upon the changed color.

⚠ CAUTION

Transmission fluids

The use of non-specified fluid (even marked as compatible with genuine) could result in a shift of quality deterioration and vibrations, and eventually, transmission failure. Use only specified Intelligent Variable Transmission (IVT) fluid. (Refer to "Recommended lubricants and capacities" on page 8-7)

Dual clutch transmission Fluid (if equipped)

Inspect the dual clutch transmission fluid according to the maintenance schedule.

Brake hoses and lines

Visually check for proper installation, chafing, cracks, deterioration and any leakage. Replace any deteriorated or damaged parts immediately.

* NOTICE

NHTSA Safety Corrosion Alert

NHTSA has warned all vehicle owners of all brands that they must maintain their vehicles in a manner which will prevent brake hose and brake line failures due to corrosion when such vehicles are exposed to winter road salt and related chemicals. While serious corrosion conditions typically only manifest themselves as safety issues after 7 years of vehicle use, the corrosion process starts immediately and thus underbody cleaning maintenance must commence from your vehicle's first exposure to road salts and chemicals. NHTSA urges vehicle owners to take the following steps to prevent corrosion:

1. Wash the undercarriage of your vehicle regularly throughout the winter and do a thorough washing in the spring to remove road salt and other de-icing chemicals.
2. Monitor the brake system for signs of corrosion by having regular professional inspections and watching for signs of problems, including loss of brake fluid,

unusual leaks and soft or spongy feel in the brake pedal.

3. Replace the entire brake pipe assembly if you find severe corrosion that causes scaling or flaking of brake components.
-

Brake fluid

Check the brake fluid level in the brake fluid reservoir. The level should be between "MIN" and "MAX" marks on the side of the reservoir. Use only hydraulic brake fluid conforming to DOT 4 specification.

Parking brake

Inspect the parking brake system including the parking brake lever (or pedal) and cables.

Exhaust pipe and muffler

Visually inspect the exhaust pipes, muffler and hangers for cracks, deterioration, or damage. Start the engine and listen carefully for any exhaust gas leakage. Tighten connections or replace parts as necessary.

Brake discs, pads and calipers

Check the pads for excessive wear, discs for run out and wear, and calipers for fluid leakage.

Suspension mounting bolts

Check the suspension connections for looseness or damage. Retighten to the specified torque.

Steering gear box, linkage & boots/ lower arm ball joint

With the vehicle stopped and off, check for excessive free-play in the steering wheel.

Check the linkage for bends or damage. Check the dust boots and ball joints for deterioration, cracks, or damage. Replace any damaged parts.

Drive shafts and boots

Check the drive shafts, boots and clamps for cracks, deterioration, or damage. Replace any damaged parts and, if necessary, repack the grease.

Air conditioning refrigerant

Check the air conditioning lines and connections for leakage and damage.

Checking fluid levels

When checking engine oil, engine coolant, brake fluid, and washer fluid, always be sure to clean the area around any filler plug, drain plug, or dipstick before checking or draining any lubricant or fluid. This

is especially important in dusty or sandy areas and when the vehicle is used on unpaved roads. Cleaning the plug and dipstick areas will prevent dirt and grit from entering the engine and other mechanisms that could be damaged.

Engine oil and filter

Engine oil is used for lubricating, cooling, and operating various hydraulic components in the engine. Engine oil consumption while driving is normal, and it is necessary to check and refill the engine oil regularly. Also, check and refill the oil level within the recommended maintenance schedule to prevent deterioration of oil performance. Check the engine oil following the below procedure.

Checking the engine oil level

1. Be sure the vehicle is on level ground.
2. Start the engine and allow it to reach normal operating temperature.

WARNING

Radiator hose

Be very careful not to touch the radiator hose when checking or adding the engine oil as it may be hot enough to burn you.

3. Turn the engine off and wait for about 15 minutes (with oil filler cap and dipstick detached) for the oil to return to the oil pan.
4. Pull the dipstick out, wipe it clean, and re-insert it fully.

⚠ CAUTION

- Do not overfill the engine oil. It may damage the engine.
- Do not spill engine oil, when adding or changing engine oil. If you drop the engine oil on the engine room, wipe it off immediately.
- When you wipe the oil level gauge, you should wipe it with a clean cloth. When mixed with debris, it can cause engine damage.
- The brake fluid constantly absorbs moisture from the air. This lowers the boiling point of the brake fluid. If the boiling point is too low, vapor pockets may form in the brake system when the brakes are applied hard.

5. Pull the dipstick out again and check the level. Check if the oil level is between the F-L line, and if it is below the L line, add enough oil to bring the level to F line.

Do not overfill. Use a funnel to help prevent oil from being spilled on engine components. Use only the specified engine oil. (Refer to "Recommended lubricants and capacities" on page 8-7.)

- Do not spill engine oil when adding or changing engine oil. Wipe off spilled oil immediately.
- The engine oil consumption may increase while you break in a new vehicle and it will be stabilized

after driving 4,000 miles (6,000 km).

- The engine oil consumption can be affected by driving habits, climate conditions, traffic conditions, oil quality, etc. Therefore, it is recommended that you inspect the engine oil level regularly and refill it if necessary.

(Gasoline) 1.6 T-GDi

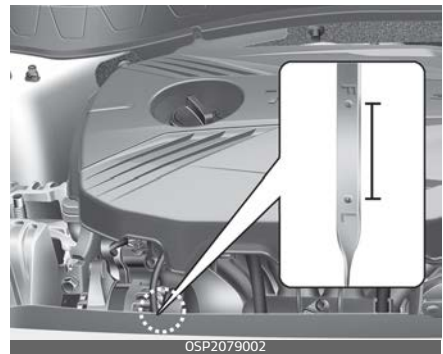

(Gasoline) 2.0 MPI

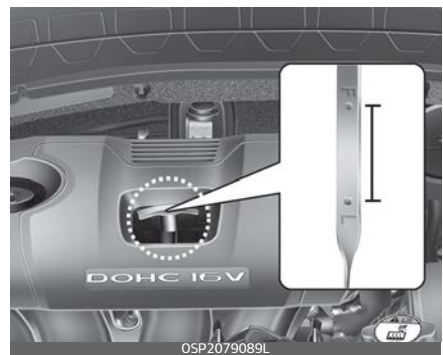

(Gasoline) 1.6 T-GDi

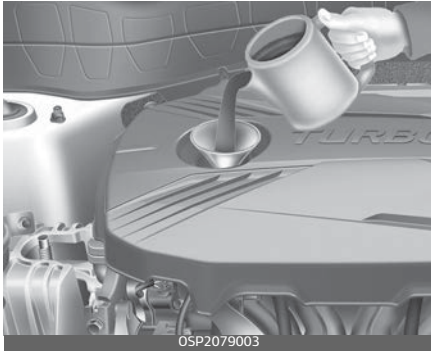

(Gasoline) 2.0 MPI



engine oil and filter. If the recommended engine oil and filter are not used replace it according to the maintenance schedule under severe usage conditions.

- The purpose of the maintenance schedule for engine oil replacement is to prevent oil deterioration and it is irrelevant to oil consumption. Check and refill engine oil regularly.

⚠ WARNING

Used engine oil may cause irritation or cancer of the skin if left in contact with the skin for prolonged periods of time. Used engine oil contains chemicals that have caused cancer in laboratory animals. Always protect your skin by washing your hands thoroughly with soap and warm water as soon as possible after handling used oil.

Changing the engine oil and filter

Have engine oil and filter changed by an authorized Kia dealer according to the Maintenance Schedule at the beginning of this chapter.

- If the maintenance schedule to replace engine oil is exceeded, the engine oil performance may deteriorate, and the engine condition may be affected. Therefore, replace the engine oil according to the maintenance schedule.
- To keep the engine in optimal condition, use the recommended

⚠ CAUTION

The engine oil is very hot immediately after the vehicle has been driven and can cause burns during replacement. Replace the engine oil after the engine oil has cooled down.

Engine coolant

The high-pressure cooling system has a reservoir filled with year round antifreeze coolant. The reservoir is filled at the factory.

Check the antifreeze protection and coolant level at least once a year, at the beginning of the winter season, and before traveling to a colder climate.

WARNING

Radiator/Inverter cap

Never attempt to remove the radiator or inverter cap while the engine is operating or hot. Doing so might lead to damage to the cooling system and engine, and could result in serious bodily injury from the escaping hot coolant or steam.

Recommended coolant

When adding coolant, use only deionized water or soft water for your vehicle and never mix hard water in the coolant filled at the factory. An improper coolant mixture can result in serious malfunction or damage.

- The engine in your vehicle has aluminum engine parts and must be protected by an phosphate based ethylene-glycol coolant to prevent corrosion and freezing.

- Do not use alcohol or methanol coolant or mix them with the specified coolant.
- Do not use a solution that contains more than 60% antifreeze or less than 35% antifreeze, which would reduce the effectiveness of the solution.
- The cooling circuit of a vehicle equipped with a heat pump system may freeze in extremely low temperature when the concentration of the antifreezing liquid is below 45%.

For mixture percentage, refer to the following table.

Ambient Temperature	Mixture Percentage (volume)	
	Antifreeze	Water
5 °F (-15 °C)	35	65
-13 °F (-25 °C)	40	60
-31 °F (-35 °C)	50	50
-49 °F (-45 °C)	60	40

⚠ WARNING



Radiator cap

Do not remove the radiator cap when the engine and radiator are hot. Scalding hot coolant and steam may blow out under pressure which may result in serious injury.

(Gasoline) 1.6 T-GDi



(Gasoline) 2.0 MPI

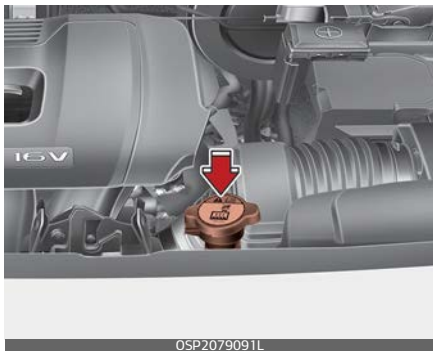

*** NOTICE**

Make sure the coolant cap is properly closed after refill or coolant. Otherwise the engine could be overheated while driving.

1. Check if the radiator cap label is straight in front.

Engine room front view



2. Make sure that the tiny protrusions inside the coolant cap are securely interlocked.

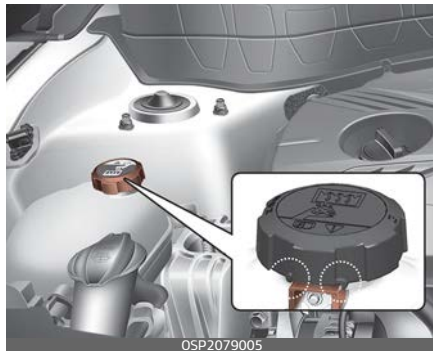

Checking the coolant level

⚠ WARNING



Removing radiator cap

Never attempt to remove the radiator cap while the engine is operating or hot. Doing so might lead to cooling system damage and could result in serious personal injury from the escaping hot coolant or steam.

1. Turn the vehicle off and wait until it cools down.
2. Use extreme care when removing the radiator cap. Wrap a thick towel around it, and turn it counterclockwise slowly to the first stop.
3. Step back while the pressure is released from the cooling system.
4. When you are sure all the pressure has been released, press down on the cap, using a thick towel, and continue turning counterclockwise to remove it.

⚠ WARNING

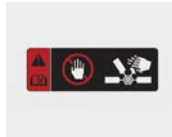

Cooling fan

Use caution when working near the blade of the cooling fan. The electric motor (cooling fan) is controlled by coolant temperature, refrigerant pressure and vehicle speed. It may sometimes operate even when the vehicle is not running.

5. Check the condition and connections of all cooling system hoses and heater hoses.
6. Replace any swollen or deteriorated hoses.
7. Check the coolant level. The coolant level should be filled between F and L marks on the side of the coolant reservoir when the engine room is cool.

(Gasoline) 1.6 T-GDi



OSP2079004

(Gasoline) 2.0 MPI

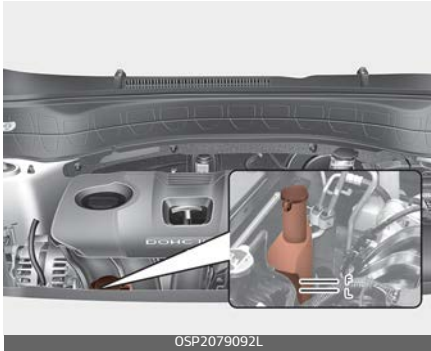

8. If the coolant level is low, add enough specified coolant to provide protection against freezing and corrosion. Bring the level to F, but do not overfill.

If frequent additions are required, see an authorized Kia dealer for a cooling system inspection.

Changing the coolant

Have the coolant changed by an authorized Kia dealer according to the Maintenance Schedule at the beginning of this chapter.

⚠ CAUTION

Put a thick cloth or fabric around the radiator cap before refilling the coolant in order to prevent the coolant from overflowing into engine parts such as the alternator.

Brake fluid

The brake fluid acts to transmit force to the brake when the driver depresses the brake pedal. Brake fluid must be maintained periodically to ensure that the brakes operate smoothly.

Checking the brake fluid level

Check the fluid level in the reservoir periodically. The fluid level should be between MAX and MIN marks on the side of the reservoir.

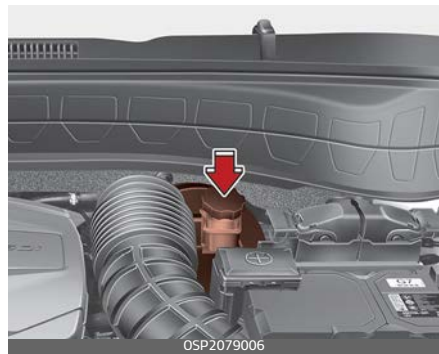

1. Before removing the reservoir cap and adding brake fluid, clean the area around the reservoir cap thoroughly to prevent brake fluid contamination.

⚠ CAUTION

Proper fluid

Only use brake fluid in the brake system. Even small amounts of improper fluids can cause damage to the brake system.

2. Periodically check that the fluid level in the brake fluid reservoir is between MIN and MAX. The level will fall with accumulated mileage. This is a normal condition associated with the wear of the brake linings. If the fluid level is excessively low, have the brake system checked by an authorized Kia dealer.

Use only the specified brake fluid. (Refer to "Recommended lubricants and capacities" on page 8-7.)

Never mix different types of fluid.

In the event the brake system requires frequent additions of fluid, the vehicle should be inspected by an authorized Kia dealer.

When changing and adding brake fluid, handle it carefully. Do not let it come in contact with your eyes. If brake fluid should come in contact with your eyes, immediately flush them with a large quantity of fresh tap water. Have your eyes examined by a doctor as soon as possible.

CAUTION

Brake fluid

Do not allow brake fluid to contact the vehicle's body paint, as paint damage will result.

Brake fluid, which has been exposed to open air for an extended time should never be used as its quality cannot be guaranteed. It should be disposed of properly.

Washer fluid

Washer fluid is used when wiping the windshield of the vehicle with a windshield wiper. You should check and refill washer fluid periodically to make sure that it doesn't run out.

Checking the washer fluid level

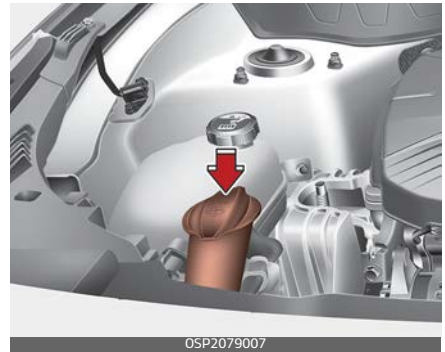

The reservoir is translucent so that you can check the level with a quick visual inspection.

- Check the fluid level in the washer fluid reservoir and add fluid if necessary. Plain water may be used if washer fluid is not available. However, use washer solvent with antifreeze characteristics in cold climates to prevent freezing.

⚠ WARNING**Flammable Fluid**

Do not allow the washer fluid to come in contact with open flames or sparks. The windshield washer fluid reservoir is flammable under certain circumstances. This can result in a fire.

⚠ WARNING**Coolant**

- Do not use radiator coolant or antifreeze in the washer fluid reservoir.
- Radiator coolant can severely obscure visibility when sprayed on the windshield and may cause loss of vehicle control.

⚠ WARNING**Windshield fluid**

Do not drink the windshield washer fluid. The windshield washer fluid is poisonous to humans and animals.

Parking brake

Inspect the parking brake system including the parking brake lever (if equipped) and cables.

Checking the parking brake

1. Check the stroke of the parking brake by counting the number of "clicks" heard while fully applying it from the released position.

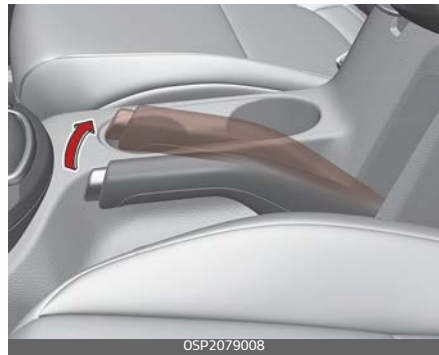

Also, the parking brake alone should securely hold the vehicle on a fairly steep grade.

2. If the stroke is more or less than specified, have the parking brake adjusted by an authorized Kia dealer.

Stroke: 5~7 "clicks" at a force of 44 lbs. (20 kg, 196 N)

Air cleaner filter

A Genuine Kia air cleaner filter is recommended when the filter is replaced.

Replacing air cleaner filter

Air cleaner filter must be replaced when necessary, and should not be washed.

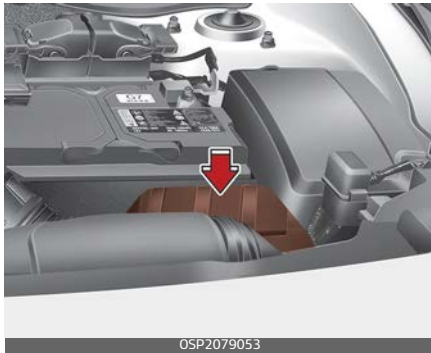

You can clean the filter when inspecting the air cleaner compartment. Clean the filter by using compressed air.

1. Loosen the air cleaner cover attaching clips and open the cover.

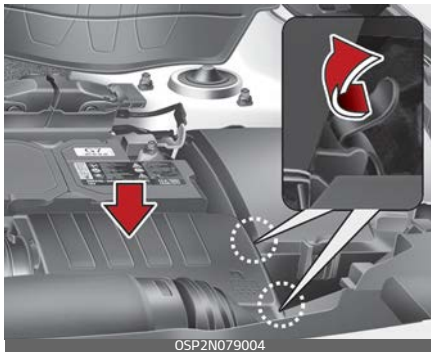

2. Wipe the inside of the air cleaner.
3. Replace the air cleaner filter.

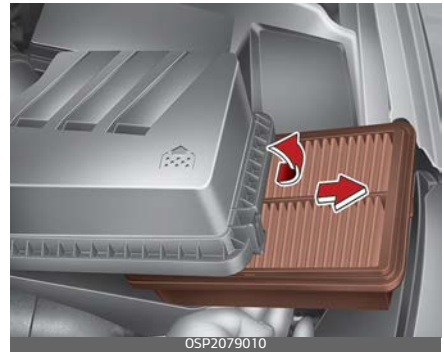

4. Insert the air cleaner cover in the hinge (1) and close the cover, then lock the cover with attaching clips.

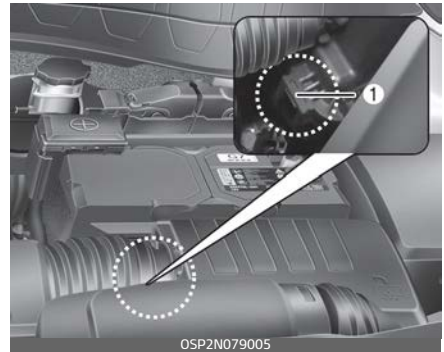

5. Check that the cover is firmly installed.

Replace the filter according to the Maintenance Schedule.

If the vehicle is operated in extremely dusty or sandy areas, replace the element more often than the usual recommended intervals. (Refer to "Maintenance Under Severe Usage Conditions – Non Turbo Models" on page 7–14.)

⚠ CAUTION**Air filter maintenance**

- Do not drive with the air cleaner removed; this will result in excessive engine wear.
 - When removing the air cleaner filter, be careful that dust or dirt does not enter the air intake, or damage may result.
 - Use a genuine Kia part. Use of a non-genuine part could damage the air flow sensor.
-

Climate control air filter

The climate control air filter should be replaced according to the maintenance schedule. If the vehicle is operated in severely air-polluted cities or on dusty rough roads for a long period, it should be inspected more frequently and replaced earlier.

Inspecting and replacing climate control air filter

When you replace the climate control air filter, replace it performing the following procedure. Be careful to avoid damaging other components.

1. Open the glove box.

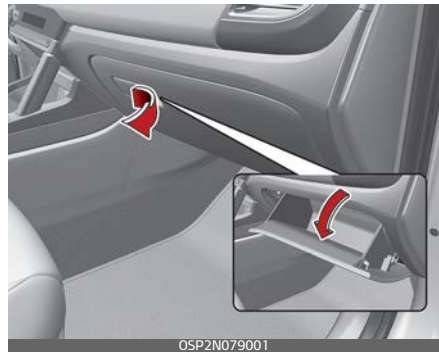

2. Remove the support rod.

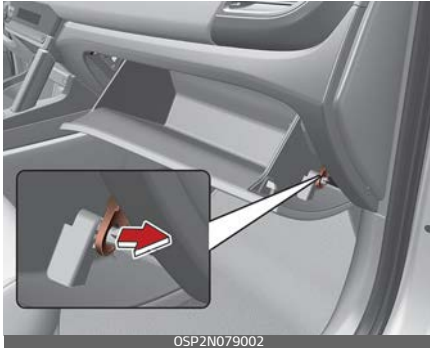

3. Remove the climate control air filter cover by pulling out right side of the cover.

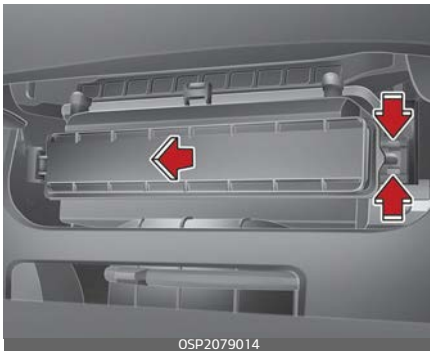

4. Replace the climate control air filter.

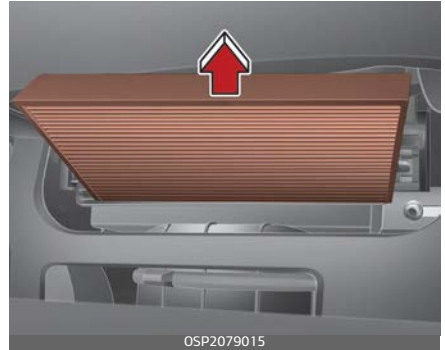

5. Reassemble in the reverse order of disassembly.

When replacing the climate control air filter, install it properly. Otherwise, the system may produce noise and the effectiveness of the filter may be reduced.

Wiper blades

When the wipers no longer clean adequately, the blades may be worn or cracked, and require replacement.

To prevent damage to the wiper arms or other components, do not attempt to move the wipers manually.

The use of a non-specified wiper blade could result in wiper malfunction and failure.

Blade inspection

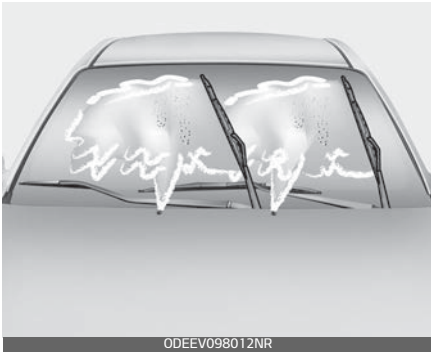

Commercial hot waxes applied by automatic vehicle washes have been known to make the windshield difficult to clean.

Contamination of either the windshield or the wiper blades with foreign matter can reduce the effectiveness of the windshield wipers. Common sources of contamination are insects, tree sap, and hot wax treatments used by some commercial vehicle washes. If the blades

are not wiping properly, clean both the window and the blades with a good cleaner or mild detergent, and rinse thoroughly with clean water.

Front windshield wiper blade

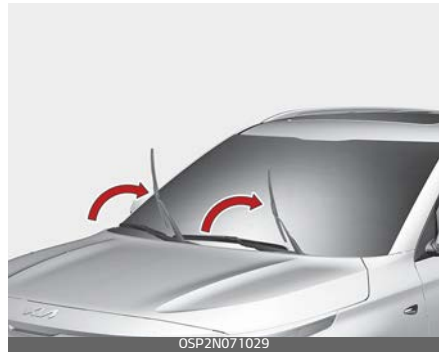

To inspect or replace the windshield wiper blades and to prevent damaging the hood, move the windshield wiper blades as follows:

Replacing front windshield wiper blade

Type A

1. Raise the wiper arm and turn the wiper blade assembly to expose the plastic locking clip.



⚠ CAUTION

Wiper arms

- Do not allow the wiper arm to fall against the windshield, since it may chip or crack the windshield.
- Do not pull the wiper arm forward, since arm could chip hood paint.

2. Compress the clip and slide the blade assembly downward.

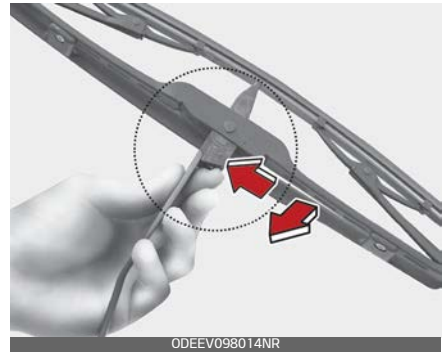

3. Lift it off the arm.

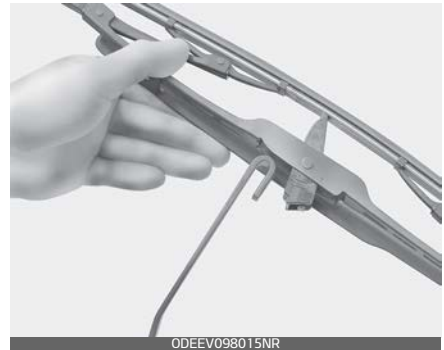

4. Install the blade assembly in the reverse order of removal.

Type B

1. Raise the wiper arm.
2. Lift up the wiper blade clip. Then pull down the blade assembly and remove it.

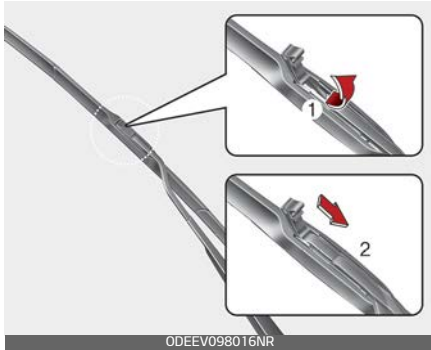

3. Install the new blade assembly.



4. Return the wiper arm on the windshield.
5. Turn ignition to the ON position and wiper arms will return to the normal operating position.

Replacing rear window wiper blade

1. Raise the wiper arm and pull out the wiper blade and install a new blade.



* NOTICE

Be careful not to rotate the wiper arm excessively when pulling out the wiper blade. The connection part could break.



To prevent damage to the wiper arms or other components, have an authorized Kia dealer replace the wiper blade.

Battery

The battery powers the engine in order to move the vehicle as well as supplying power to the various devices installed in the vehicle.

For best battery service

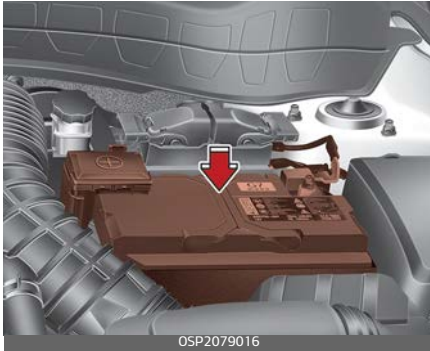

- Keep the battery securely mounted.
- Keep the battery top clean and dry.
- Keep the terminals and connections clean, tight, and coated with petroleum jelly or terminal grease.
- Rinse any spilled electrolyte from the battery immediately with a solution of water and baking soda.
- If the vehicle is not going to be used for an extended time, disconnect the battery cables.

⚠ WARNING

Risk of explosion



Keep lit cigarettes and all other flames or sparks away from the battery.



The battery contains hydrogen -- a highly combustible gas which will explode if it comes in contact with a flame or spark.



Keep batteries out of the reach of children because batteries contain highly corrosive SULFURIC ACID and electrolytes. Do not allow battery acid to contact your skin, eyes, clothing or paint finish.



Wear eye protection when charging or working near a battery. Always provide ventilation when working in an enclosed space.



Always read the following instructions carefully when handling a battery.



If any electrolyte gets into your eyes, flush your eyes with clean water for at least 15 minutes and get immediate medical attention. If electrolyte gets on your skin, thoroughly wash the contacted area. If you feel pain or burning sensation, get medical attention immediately.



An inappropriately disposed battery can be harmful to the environment and human health.

Dispose the battery according to your local law(s) or regulation.



The battery contains lead. Do not dispose of it after use. Please return the battery to an authorized Kia dealer to be recycled.

Never attempt to recharge the battery when the battery cables are connected.

Never attempt to recharge the battery when the battery cables are connected.

⚠ WARNING

Risk of electrocution

Never touch the electrical ignition system while the vehicle is running. This system works with high voltage, which can "zap" you.

* NOTICE

If you connect unauthorized electronic devices to the battery, the battery may be discharged. Never use unauthorized devices.

⚠ WARNING

Recharging battery

Never attempt to recharge the battery when the battery cables are connected.

⚠ WARNING

Battery lead compound

Battery posts, terminals, and related accessories contain lead and lead compounds. Wash hands after handling.

Battery recharging

Your vehicle has a maintenance-free, calcium-based battery

- If the battery becomes discharged in a short time (because, for example, the headlights or interior lights were left on while the vehicle was not in use), recharge it by slow charging (trickle) for 10 hours.
- If the battery gradually discharges because of high electric load while the vehicle is being used, recharge it at 20~30 A for two hours.

When recharging the battery, observe the following precautions:

- The battery must be removed from the vehicle and placed in an area with good ventilation.
- Do not allow cigarettes, sparks, or flame near the battery.
- Watch the battery during charging, and stop or reduce the charging rate in following cases:
 1. the battery cells begin gassing (boiling) violently

- 2. the electrolyte temperature of any cell exceeds 120 °F (49 °C).
- Wear eye protection when checking the battery during charging.
- Disconnect the battery charger in the following order.
 1. Turn off the battery charger main switch.
 2. Unhook the negative clamp from the negative battery terminal.
 3. Unhook the positive clamp from the positive battery terminal.
- Before performing maintenance or recharging the battery, turn off all accessories and stop the vehicle.
- The negative battery cable must be removed first and installed last when the battery is disconnected.
- Do not open or remove the cap on top of the battery. This may cause leaks of internal electrolyte that could result in severe injury.

Reset items

The following items should be reset after the battery has been discharged or the battery has been disconnected.

- Auto up/down window (Refer to "Window opening and closing" on page 4-32)
- Trip computer (Refer to "Trip information (trip computer)" on page 4-68)
- Climate control system (Refer to "Automatic climate control system" on page 4-124)
- Sunroof (Refer to "Sunroof (if equipped)" on page 4-41)

CAUTION

AGM battery

- Absorbent Glass Mat (AGM) batteries are maintenance free and have the AGM battery serviced by an authorized Kia dealer.
For charging your AGM battery, use only fully automatic battery chargers that are specially developed for AGM batteries.
- When replacing the AGM battery, use parts for replacement from an authorized Kia dealer.

Tires and wheels

For proper maintenance, safety, and maximum fuel economy, you must always maintain the recommended tire inflation pressures and stay within the load limits and weight distribution recommended for your vehicle.

Recommended cold tire inflation pressures

All tire pressures should be checked when the tires are cold. "Cold Tires" means the vehicle has not been driven for at least three hours or driven less than 1 mile (1.6 km).

Recommended pressures must be maintained for the best ride, vehicle handling, and minimum tire wear.

For recommended inflation pressure, refer to "Tires and wheels" on page 8-6.

All specifications (sizes and pressures) can be found on a label attached to the driver's side center pillar.



OSP2N079003

⚠ WARNING

Tire underinflation

Inflate your tires consistent with the instructions provided in this manual. Regularly check the tire inflation pressure, and correct it as needed; at least twice a month and before any long trips on the road. If you fail to observe this precaution, you may be driving on underinflated tires, which may not only compromise your vehicle's driving stability, but may also lead to tire damage and the risk of an accident. This risk is much higher on hot days and when driving for long periods at high speeds.

Failure to maintain specified pressure may result in excessive wear, poor handling, reduced fuel economy, deformation of tire and/or wheel, harsh ride conditions, possibility for additional damage from road hazards, or result in tire failure.

Tire pressure

Always observe the following:

- Check tire pressure when the tires are cold. (After vehicle has been parked for at least three hours or hasn't been driven more than 1 mile (1.6 km) since startup.)
- Check the pressure of your spare tire each time you check the pressure of other tires.
- Never overload your vehicle. Be careful not to overload a vehicle luggage rack if your vehicle is equipped with one.
- Warm tires normally exceed recommended cold tire pressures by 4-6 psi (28-41 kPa). Do not release air from warm tires to adjust the pressure or the tires will be underinflated.

WARNING

Tire Inflation

Overinflation or underinflation can reduce tire life, adversely affect vehicle handling, and lead to sudden tire failure. This could result in loss of vehicle control and potential injury.

Checking tire inflation pressure

Check your tires once a month or more.

Use a good quality gauge to check tire pressure. You cannot tell if your tires are properly inflated simply by looking at them. Radial tires may look properly inflated even when they're underinflated.

Check the tire's inflation pressure when the tires are cold. "Cold" means your vehicle has been sitting or at least three hours or driven no more than 1 mile (1.6 km).

1. Remove the valve cap from the tire valve stem.
2. Press the tire gauge firmly onto the valve to get a pressure measurement. If the cold tire inflation pressure matches the recommended pressure on the tire and loading information label, no further adjustment is necessary.
3. If the pressure is low, add air until you reach the recommended amount.
4. If you overfill the tire, release air by pushing on the metal stem in the center of the tire valve.
5. Recheck the tire pressure with the tire gauge.
6. Be sure to put the valve caps back on the valve stems. They help prevent leaks by keeping out dirt and moisture.

Inspect your tires frequently for proper inflation as well as wear and

damage. Always use a tire pressure gauge.

Tires with too much or too little pressure wear unevenly. This could result in poor handling, loss of vehicle control, and sudden tire failure leading to accidents, injuries, and even death. The recommended cold tire pressure for your vehicle can be found in this manual and on the tire label located on the driver's side center pillar.

Tire rotation

To equalize tread wear, it is recommended that the tires be rotated every 7,500 miles (12,000 km) or sooner if irregular wear develops.

During rotation, check the tires for correct balance.

When rotating tires, check for uneven wear and damage. Abnormal wear is usually caused by incorrect tire pressure, improper wheel alignment, out-of-balance wheels, severe braking or severe cornering. Look for bumps or bulges in the tread or side of tire. Replace the tire if you find either of these conditions.

Replace the tire if fabric or cord is visible. After rotation, be sure to bring the front and rear tire pressures to specification and check lug nut tightness. (proper torque is 79~94 lbf·ft [11~13 kgf·m])

Refer to "Tires and wheels" on page 8-6.

Disc brake pads should be inspected for wear whenever tires are rotated.

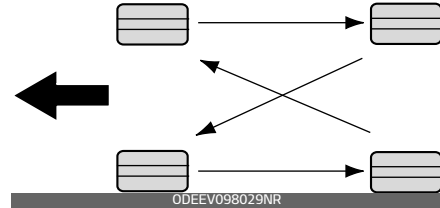

Rotate radial tires that have an asymmetric tread pattern only from front to rear and not from right to left.

⚠ WARNING

Mixing tires

Do not mix bias ply and radial ply tires under any circumstances. This may cause unusual handling characteristics.

Wheel alignment and tire balance

The wheels on your vehicle were aligned and balanced carefully at the factory to give you the longest tire life and best overall performance.

In most cases, you will not need to have your wheels aligned again. However, if you notice unusual tire wear or your vehicle pulling one way or the other, the alignment may need to be reset.

If you notice your vehicle vibrating when driving on a smooth road, your wheels may need to be rebalanced.

⚠ CAUTION

Wheel weight

Improper wheel weights can damage your vehicle's aluminum wheels. Use only approved wheel weights.

Tire replacement

If the tire is worn evenly, a tread wear indicator will appear as a solid band across the tread.



This shows there is less than 1/16 inch (1.6 mm) of tread left on the tire. Replace the tire when this happens.

Do not wait for the band to appear across the entire tread before replacing the tire.

The Anti-lock Brake System (ABS) works by comparing the speed of

the wheels. The tire size affects wheel speed. When replacing tires, all 4 tires must use the same size originally supplied with the vehicle. Using tires of a different size can cause the ABS and Electronic Stability Control (ESC) to work irregularly.

It is best to replace all four tires at the same time. If that is not possible, or necessary, then replace the two front or two rear tires as a pair. Replacing just one tire can seriously affect your vehicle's handling.

* NOTICE

We recommend that when replacing tires, use the same ones as those that were originally supplied with the vehicles. If not, that affects driving performance.

Wheel replacement

When replacing the metal wheels for any reason, make sure the new wheels are equivalent to the original factory units in diameter, rim width and offset.

A wheel with an incorrect size may adversely affect many things: wheel and bearing life, braking and stopping abilities, handling characteristics, ground clearance, body-to-tire clearance, snow chain clearance, speedometer and odometer calibra-

tion, headlight aiming and bumper height.

⚠ CAUTION

Wheels

Wheels that do not meet Kia specifications may fit poorly and result in damage to the vehicle or unusual handling and poor vehicle control.

Tire traction

Tire traction can be reduced if you drive on worn tires, tires that are improperly inflated or on slippery road surfaces.

Tires should be replaced when tread wear indicators appear. Slow down whenever there is rain, snow or ice on the road to reduce the possibility of losing control of the vehicle.

Tire maintenance

In addition to proper inflation, correct wheel alignment helps to decrease tire wear.

If you find a tire is worn unevenly, have your dealer check the wheel alignment.

When you have new tires installed, make sure they are balanced. This will increase vehicle ride comfort and tire life. Additionally, a tire should always be rebalanced if it is removed from the wheel.

Tire sidewall labeling

This information identifies and describes the fundamental characteristics of the tire and also provides the Tire Identification Number (TIN) for safety standard certification.

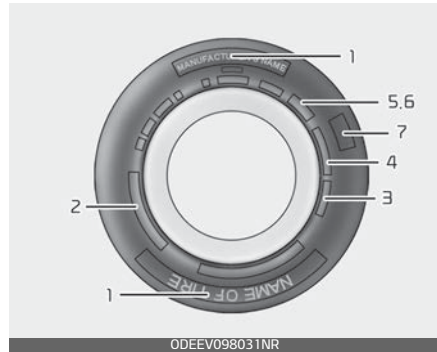

The TIN can be used to identify the tire in case of a recall.

1. *Manufacturer or brand name*

Manufacturer or Brand name is shown.

2. *Tire size designation*

A tire's sidewall is marked with a tire size designation. You will need this information when selecting replacement tires for your vehicle. The following explains what the letters and numbers in the tire size designation mean.

Example tire size designation:

(These numbers are provided as an example only; your tire size designation will vary.)

nator could vary depending on your vehicle.)

P235/45R18 108T

- P: Applicable vehicle type (tires marked with the prefix "P" are intended for use on passenger vehicles or light trucks; however, not all tires have this marking).
- 235: Tire width in millimeters.
- 645: Aspect ratio. The tire's section height as a percentage of its width.
- R: Tire construction code (Radial).
- 18: Rim diameter in inches.
- 108: Load Index, a numerical code associated with the maximum load the tire can carry.
- T: Speed Rating Symbol. See the speed rating chart in this section for additional information.

Wheel size designation

Wheels are also marked with important information that you need if you ever have to replace one. The following explains what the letters and numbers in the wheel size designation mean.

Example wheel size designation:

7.0JX17

- 7.0: Rim width in inches.
- J: Rim contour designation.
- 17: Rim diameter in inches.

Tire speed ratings

The chart below lists many of the different speed ratings currently being used for passenger vehicle

tires. The speed rating is part of the tire size designation on the sidewall of the tire. This symbol corresponds to that tire's designed maximum safe operating speed.

Speed Rating Symbol	Maximum Speed
S	112 mph (180 km/h)
T	118 mph (190 km/h)
H	130 mph (210 km/h)
V	149 mph (240 km/h)
W	168 mph (270 km/h)
Y	186 mph (300 km/h)

3. Checking tire life

Any tires that are over 6 years old, based on the manufacturing date, should be replaced by new ones. You can find the manufacturing date on the tire sidewall (possibly on the inside of the wheel), displaying the DOT code. The DOT code is a series of numbers on a tire consisting of numbers and English letters. The manufacturing date is designated by the last four digits (characters) of the DOT code.

DOT: XXXX XXXX 0000

The front part of the DOT means a plant code number, tire size and tread pattern and the last four numbers indicate week and year manufactured.

For example:

DOT XXXX XXXX 1621 represents that the tire was produced in the 16th week of 2021.

⚠ WARNING

Tire age

Replace tires within the recommended time frame. Failure to replace tires as recommended can result in sudden tire failure, which could lead to a loss of control and an accident.

4. Tire ply composition and material

The number of layers or plies of rubber-coated fabric in the tire. Tire manufacturers also must indicate the materials in the tire, which include steel, nylon, polyester, and others. The letter "R" means radial ply construction; the letter "D" means diagonal or bias ply construction; and the letter "B" means belted-bias ply construction.

5. Maximum permissible inflation pressure

This number is the greatest amount of air pressure that should be put in the tire. Do not exceed the maximum permissible inflation pressure. Refer to "Tire and loading information label" on page 5-191 for recommended inflation pressure.

6. Maximum load rating

This number indicates the maximum load in kilograms and pounds that can be carried by the tire. When replacing the tires on the vehicle, always use a tire that has the same load rating as the factory installed tire.

7. Uniform tire quality grading

Quality grades can be found where applicable on the tire sidewall between tread shoulder and maximum section width.

For example:

- Treadwear 200
- Traction AA
- Temperature A

Tires degrade over time, even when they are not being used. Regardless of the remaining tread, we recommend that tires be replaced after approximately six (6) years of normal service. Heat caused by hot climate or frequent high loading conditions can accelerate the aging process.

Tread wear

The tread wear grade is a comparative rating based on the wear rate of the tire when tested under controlled conditions on a specified government test course. For example, a tire graded 150 would wear one-and-a-half times ($1\frac{1}{2}$) as well

on the government course as a tire graded 100.

The relative performance of tires depends upon the actual conditions of their use. Performance may depart significantly from the norm due to variations in driving habits, service practices and differences in road characteristics and climate. These grades are molded on the side-walls of passenger vehicle tires. The tires available as standard or optional equipment on your vehicle may vary with respect to grade.

Traction – AA, A, B & C

The traction grades, from highest to lowest, are AA, A, B and C. Those grades represent the tire's ability to stop on wet pavement as measured under controlled conditions on specified government test surfaces of asphalt and concrete. A tire marked C may have poor traction performance.

The traction grade assigned to this tire is based on straight-ahead braking traction tests, and does not include acceleration, cornering, hydroplaning, or peak traction characteristics.

Temperature –A, B & C

The temperature grades are A (the highest), B and C representing the tire's resistance to the generation of heat and its ability to dissipate heat when tested under controlled conditions on a specified indoor laboratory test wheel.

Sustained high temperature can cause the material of the tire to degenerate and reduce tire life, and excessive temperature can lead to sudden tire failure. The grade C corresponds to a level of performance which all passenger vehicle tires must meet under the Federal Motor Vehicle Safety Standard No. 109. Grades B and A represent higher levels of performance on the laboratory test wheel than the minimum required by law.

Tire terminology and definitions

Refer to the following for detailed definitions of the terms that are found in the tire description.

Air Pressure The amount of air inside the tire pressing outward on the tire. Air pressure is expressed in pounds per square inch (psi) or kilopascal (kPa).

Accessory Weight The combined weight of optional accessories. Some examples of optional accessories are automatic transmission, power seats, and air conditioning.

Aspect Ratio The relationship of a tire's height to its width.

Belt A rubber coated layer of cords that is located between the plies and the tread. Cords may be made from steel or other reinforcing materials.

Bead The tire bead contains steel wires wrapped by steel cords that hold the tire onto the rim.

Bias Ply Tire A pneumatic tire in which the plies are laid at alternate angles less than 90 degrees to the centerline of the tread.

Cold Tire Pressure The amount of air pressure in a tire, measured in pounds per square inch (psi) or kilopascals (kPa) before a tire has built up heat from driving.

Curb Weight The weight of a motor vehicle with standard and optional equipment (including the maximum capacity of fuel, oil and coolant), but without passengers and cargo.

DOT Markings A code molded into the sidewall of a tire signifying that the tire is in compliance with the U.S. Department of Transportation motor vehicle safety standards. The DOT code includes the Tire Identification Number (TIN), an alphanumeric designator which can also identify the tire manufacturer, production plant, brand and date of production.

GVWR Gross Vehicle Weight Rating

GAWR FRT Gross Axle Weight Rating for the Front axle.

GAWR RR Gross Axle Weight Rating for the Rear axle.

Intended Outboard Sidewall The side of an asymmetrical tire that must always face outward when mounted on a vehicle.

Kilopascal (kPa) The metric unit for air pressure.

Light truck (LT) tire A tire designated by its manufacturer as primarily intended for use on lightweight trucks or multipurpose passenger vehicles.

Load ratings The maximum load that a tire is rated to carry for a given inflation pressure.

Load Index An assigned number ranging from 1 to 279 that corresponds to the load carrying capacity of a tire.

Maximum Inflation Pressure The maximum air pressure to which a cold tire may be inflated. The maximum air pressure is molded onto the sidewall.

Maximum Load Rating The load rating for a tire at the maximum permissible inflation pressure for that tire.

Maximum Loaded Vehicle Weight The sum of curb weight; accessory weight; vehicle capacity weight; and production options weight.

Normal Occupant Weight The number of occupants a vehicle is

designed to seat multiplied by 150 lbs. (68 kg).

Occupant Distribution Designated seating positions.

Outward Facing Sidewall The side of an asymmetrical tire that has a particular side that faces outward when mounted on a vehicle. The outward facing sidewall bears white lettering or bears manufacturer, brand, and/or model name molding that is higher or deeper than the same moldings on the inner facing sidewall.

Passenger (P-Metric) Tire A tire used on passenger cars and some light duty trucks and multipurpose vehicles.

Ply A layer of rubber-coated parallel cords.

Pneumatic tire A mechanical device made of rubber, chemicals, fabric and steel or other materials, that, when mounted on an automotive wheel, provides the traction and contains the gas or fluid that sustains the load.

Production options weight The combined weight of installed regular production options weighing over 5 lbs. (2.3 kg) in excess of the standard items which they replace, not previously considered in curb weight or accessory weight. Examples include heavy duty brakes, ride lev-

elers, roof rack, heavy duty battery, and special trim.

Recommended Inflation Pressure

Vehicle manufacturer's recommended tire inflation pressure and shown on the tire placard.

Radial Ply Tire A pneumatic tire in which the ply cords that extend to the beads are laid at 90 degrees to the centerline of the tread.

Rim A metal support for a tire and upon which the tire beads are seated.

Sidewall The portion of a tire between the tread and the bead.

Speed Rating An alphanumeric code assigned to a tire indicating the maximum speed at which a tire can operate.

Traction The friction between the tire and the road surface. The amount of grip provided.

Tread The portion of a tire that comes into contact with the road.

Treadwear Indicators Narrow bands, sometimes called "wear bars," that show across the tread of a tire when only 2/32 inch (1.6 mm) of tread remains.

UTQGS Uniform Tire Quality Grading Standards, a tire information system that provides consumers with ratings for a tire's traction, temperature and treadwear. Ratings are

determined by tire manufacturers using government testing procedures. The ratings are molded into the sidewall of the tire.

Vehicle Capacity Weight The weight of designated seating positions multiplied by 150 lbs. (68 kg) plus the rated cargo and luggage load.

Vehicle Maximum Load on the Tire Load on an individual tire due to curb and accessory weight plus maximum occupant and cargo weight.

Vehicle Normal Load on the Tire Load on an individual tire that is determined by distributing to each axle its share of the curb weight, accessory weight, and normal occupant weight and driving by 2.

Vehicle Placard A label permanently attached to a vehicle showing the original equipment tire size and recommended inflation pressure.

All season tires

Kia specifies all season tires on some models to provide good performance for use all year round, including snowy and icy road conditions.

All season tires are identified by ALL SEASON and/or M+S (Mud and Snow) on the tire sidewall. Snow tires have better snow traction than all season tires and may be more appropriate in some areas.

Summer tires

Kia specifies summer tires on some models to provide superior performance on dry roads.

Summer tire performance is substantially reduced in snow and ice. Summer tires do not have the tire traction rating M+S (Mud and Snow) on the tire side wall. If you plan to operate your vehicle in snowy or icy conditions, Kia recommends the use of snow tires or all season tires on all four wheels.

Snow tires

If you equip your vehicle with snow tires, they should be the same size and have the same load capacity as the original tires.

Snow tires should be installed on all four wheels; otherwise, poor handling may result.

Snow tires should carry 4 psi (28 kPa) more air pressure than the pressure recommended for the standard tires on the tire label on the driver's side of the center pillar, or up to the maximum pressure shown on the tire sidewall, whichever is less.

Do not drive faster than 75 mph (120 km/h) when your vehicle is equipped with snow tires.

WARNING

Do not use summer tires at temperatures below 45 °F (7 °C) or when driving on snow or ice. At temperatures below 45 °F (7 °C), summer tires can lose elasticity, and therefore traction and braking power as well. Change the tires on your vehicle to winter or all-weather tires of the same size as the standard tires of the vehicle. Both types of tires are identified by the M+S (Mud and Snow) marking. Using summer tires at very cold temperatures could cause cracks to form, thereby damaging the tires permanently.

Tire chains

Tire chains, if necessary, should be installed on the front wheels.

Be sure that the chains are installed in accordance with the manufacturer's instructions.

To minimize tire and chain wear, do not continue to use tire chains when they are no longer needed.

- When driving on roads covered with snow or ice, drive at less than 20 mph (30 km/h).
- Use the SAE "S" class or wire chains.
- If you hear noise caused by chains contacting the body, retighten the

chain to avoid contact with the vehicle body.

- To prevent body damage, retighten the chains after driving 0.3~0.6 miles (0.5~1.0 km).
- Do not use tire chains on vehicles equipped with aluminum wheels. In unavoidable circumstance, use a wire type chain.
- Use wire chains less than 0.47 inches (12 mm) to prevent damage to the chain's connection.

Radial-ply tires

Radial-ply tires provide improved tread life, road hazard resistance and smoother high speed ride.

The radial-ply tires used on this vehicle are of belted construction, and are selected to complement the ride and handling characteristics of your vehicle. Radial-ply tires have the same load carrying capacity, as bias-ply or bias belted tires of the same size, and use the same recommended inflation pressure.

Mixing of radial-ply tires with bias-ply or bias belted tires is not recommended. Any combinations of radial-ply and bias-ply or bias belted tires when used on the same vehicle will seriously deteriorate vehicle handling. The best rule to follow is: Identical radial-ply tires should always be used as a set of four.

Longer wearing tires can be more susceptible to irregular tread wear. It is very important to follow the tire rotation interval shown in this section to achieve the tread life potential of these tires. Cuts and punctures in radial-ply tires are repairable only in the tread area, because of sidewall flexing. Consult your tire dealer for radial-ply tire repairs.

Low aspect ratio tire (if equipped)

Low aspect ratio tires, whose aspect ratio is lower than 50, are provided for sporty looks.

Because the low aspect ratio tires are optimized for handling and braking, it may be more uncomfortable to ride in and there is more noise compare with normal tires.

⚠ CAUTION

Because the sidewall of the low aspect ratio tire is shorter than normal, the wheel and tire of the low aspect ratio tire is more easily damaged. So, follow the instructions below.

- When driving on a rough road or off road, drive cautiously because tires and wheels may be damaged. And after driving, inspect tires and wheels.
- When passing over a pothole, speed bump, manhole, or curb

stone, drive slowly so that the tires and wheels are not damaged.

- If the tire is impacted, we recommend that you inspect the tire condition or contact an authorized Kia dealer.
 - To prevent damage to the tire, inspect the tire condition and pressure every 1,900 miles (3,000 km).
-
- It is not easy to recognize the tire damage with your own eyes. But if there is the slightest hint of tire damage, even though you cannot see the tire damage with your own eyes, have the tire checked or replaced because the tire damage may cause air leakage from the tire.
 - If the tire is damaged by driving on a rough road, off road, pothole, manhole, or curb stone, it will not be covered by the warranty.
 - You can find out the tire information on the tire sidewall.

Fuses

A vehicle's electrical system is protected from electrical overload damage by fuses.

Blade type



Cartridge type



Multi fuse

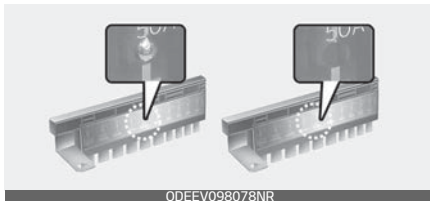

BFT



* Left side: Normal, Right side: Blown

This vehicle has 2 (or 3) fuse panels, one located in the driver's side panel bolster, the other in the engine compartment near the battery.

If any of your vehicle's lights, accessories, or controls do not work, check the appropriate circuit fuse. If a fuse has blown, the element inside the fuse will melt.

If the electrical system does not work, first check the driver's side fuse panel.

If the replacement fuse blows, this indicates an electrical problem. Avoid using the system involved and immediately consult an authorized Kia dealer.

Three kinds of fuses are used: blade type for lower amperage rating, cartridge type, and multi fuse for higher amperage ratings.

⚠ WARNING

Fuse replacement

- Never replace a fuse with anything but another fuse of the same rating.
- A higher capacity fuse could cause damage and possibly a fire.
- Never install a wire or aluminum foil instead of the proper fuse - even as a temporary repair. It may cause extensive wiring damage and a possible fire.

- Do not arbitrarily modify or add-on electric wiring to the vehicle.

* NOTICE

- When replacing a fuse, turn ENGINE START/STOP button to the OFF position and turn off switches of all electrical devices, then remove battery (-) terminal.
- The actual fuse/relay panel label may differ from equipped items.

⚠ WARNING

Electrical Fire

Always ensure replacement fuses and relays are securely fastened when installed. Failure to do so can result in a vehicle fire.

Do not remove fuses, relays and terminals fastened with bolts or nuts. The fuses, relays and terminals may be fastened incompletely, and it may cause a possible fire. If fuses, relays and terminals fastened with bolts or nuts are blown, consult with an authorized Kia dealer.

⚠ CAUTION

When replacing a blown fuse or relay, make sure the new fuse or relay fits tightly into the clips. Failure to tightly install the fuse or

relay may cause damage to the wiring and electric systems.

⚠ CAUTION

- Do not input any other objects except fuses or relays into fuse/relay terminals, such as a screwdriver or wiring. It may cause contact failure and system malfunction.
- Do not plug in screwdrivers or aftermarket wiring into the terminal originally designed for fuse and relays only. The electrical system and wiring of the vehicle interior may be damaged or burned due to contact failure.
- If you directly connect the wire on the taillight or replace the bulb, which is over the regulated capacity to install trailers etc., the inner junction block can get burned.

⚠ WARNING

Electrical wiring repairs

All electrical repairs should be performed by authorized Kia dealerships using approved Kia parts. Using other wiring components, especially when retrofitting multimedia or theft alarm system, car phone or radio may cause vehicle damage and increase the risk of a vehicle fire.

* NOTICE

Remodeling Prohibited

Do not rewire your vehicle in any way, as doing so may affect the performance of several safety features in your vehicle. Rewiring your vehicle may also void your warranty and cause you to be responsible for any subsequent vehicle damage, which may result.

Replacing inner panel fuse

1. Turn the ENGINE START/STOP button to the OFF position and all other switches off.
2. Open the fuse panel cover.

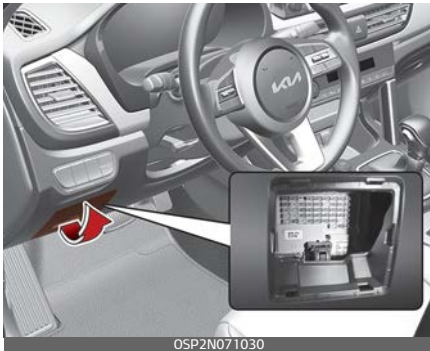

3. Pull the suspected fuse straight out. Use the removal tool provided on the engine fuse panel cover.

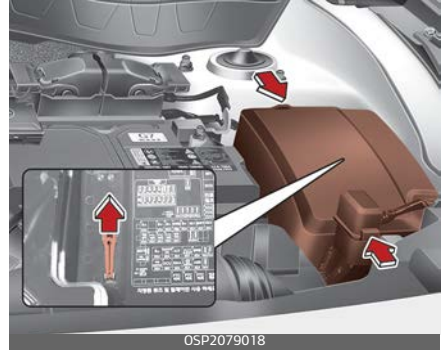

4. Check the removed fuse; replace it if it is blown.
5. Push in a new fuse of the same rating, and make sure it fits tightly in the clips.

If it fits loosely, consult an authorized Kia dealer.

If you do not have a spare, use a fuse of the same rating from a circuit you may not need for operating the vehicle, such as the power outlet fuse.

If the head lamp, turn signal lamp, stop signal lamp, fog lamp, DRL, tail lamp, High Mounted Stop Lamp (HMSL) do not work and the fuses are OK, check the fuse panel in the engine compartment. If a fuse is blown, it must be replaced.

* NOTICE

If the headlamp, fog lamp, turn signal lamp, or tail lamp malfunctions, even without any problem to the lamps, have the vehicle checked by an authorized Kia dealer for assistance.

Replacing engine compartment fuse

1. Turn the ENGINE START/STOP button to the OFF position and all other switches off.
2. Remove the fuse panel cover by pressing the tab and pulling the cover up.

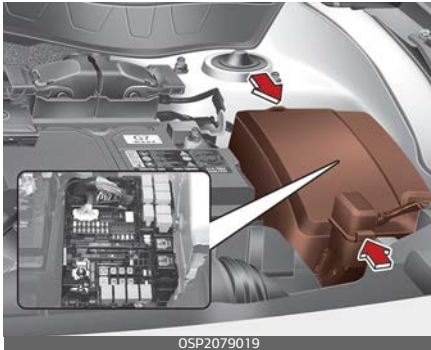

3. Check the removed fuse; replace it if it is blown. To remove or insert the fuse, use the fuse puller in the engine compartment fuse panel.
4. Push in a new fuse of the same rating, and make sure it fits tightly in the clips. If it fits loosely, consult an authorized Kia dealer.

⚠ CAUTION

Always securely install the fuse panel cover in the engine compartment to protect against electrical failure which may occur from water contact. Listen for the audible clicking sound to ensure fuse panel cover is securely fastened.

Multi fuse

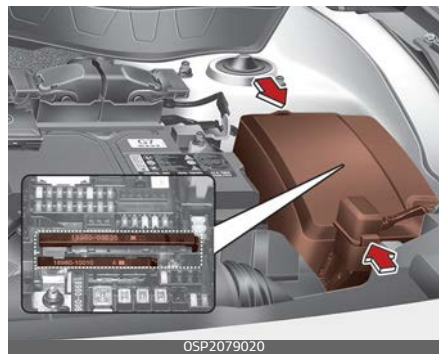

If the multi fuse is blown, it must be removed as follows:

1. Turn the ENGINE START/STOP button to the OFF position and all other switches off.
2. Disconnect the negative battery cable.
3. Remove the nuts shown in the picture above.
4. Replace the fuse with a new one of the same rating.
5. Reverse these steps to reinstall the multi fuse.

* NOTICE

Do not disassemble nor assemble the multi fuse when it is secured with nuts and bolts. Incorrect or partial assembly torque may cause a fire. Have the vehicle checked by an authorized Kia dealer.

Main fuse

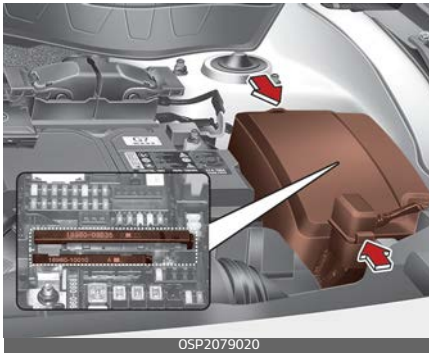

If the main fuse is blown, it must be removed as follows:

1. Turn the ENGINE START/STOP button to the OFF position and all other switches off.
2. Disconnect the negative battery cable.
3. Remove the nuts shown in the picture above.
4. Replace the fuse with a new one of the same rating.
5. Reverse these steps to reinstall the multi fuse.

* NOTICE

The electronic system may not function correctly even when the engine compartment and internal fuse box's individual fuses are not disconnected. In such cases, the cause of the problem may be disconnection of the main fuse (BFT type), which is located inside the positive battery terminal (+) cap. Since the main fuse is designed more intricately than other parts, have the vehicle checked by an authorized Kia dealer.

* NOTICE

Do not disassemble nor assemble the multi fuse when it is secured with nuts and bolts. Incorrect or partial assembly torque may cause a fire. Have the vehicle checked by an authorized Kia dealer.

Battery fuse

If the battery fuse is blown, it must be removed as follows:

1. Disconnect the negative battery cable.
2. Remove the nuts shown in the picture below.

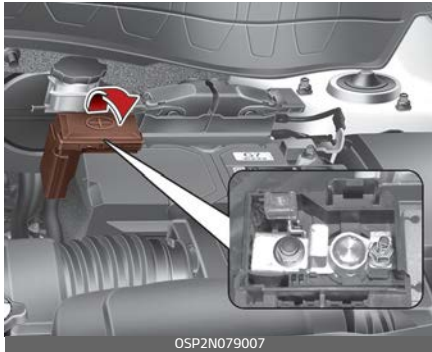

3. Replace the fuse with a new one of the same rating.
4. Reinstall in the reverse order of removal.

* NOTICE

If the battery fuse is blown, have the vehicle checked by an authorized Kia dealer.

⚠ CAUTION

Visually inspect the battery cap to ensure it is securely closed. If the battery cap is not securely closed, moisture may enter the system and damage the electrical components.

Fuse/relay panel description

Inside the fuse/relay panel covers, you can find the fuse/relay label describing fuse/relay name and capacity.

Driver's side fuse panel



* NOTICE

Not all fuse panel descriptions in this manual may be applicable to your vehicle. It is accurate at the time of printing. When you inspect the fuse panel in your vehicle, refer to the fuse panel label on the inside of the fuse cover. This diagram will provide you with the specific information for your vehicles.

P/SEAT (PASS)	30A	WIPER RR	15A	-	-	-	-	¹ WIPER FRT	10A	-	-	ISG	15A	MDPS	7.5A	⁸ MODULE	7.5A
P/SEAT (DRV)	30A	-	-	S/HEATER RR	15A	¹ IBU	15A	² AIR BAG	10A	IG1	25A	³ IBU	7.5A	A/BAG IND	7.5A	² A/C	10A
AMP	25A	S/HEATER FRT	20A	¹ MODULE	7.5A	START	7.5A	-	-	-	-	⁶ MODULE	10A	CLUSTER	7.5A	⁷ MODULE	7.5A
P/WINDOW RH	25A	SUNROOF	20A	BRAKE SWITCH	10A	-	-	² MEMORY	10A	⁴ MODULE	7.5A	³ MODULE	7.5A	¹ A/C	7.5A	-	-
P/WINDOW LH	25A	TAILGATE OPEN	10A	DOOR LOCK	20A	-	-	MULTI MEDIA	15A	HEATED MIRROR	10A	¹ AIR BAG	15A	POWER OUTLET	20A	WASHER	15A
												² WIPER FRT	25A	² MODULE	10A	-	-

OSP2N079500

Refer to the following table for a description of the fuse.

Fuse Name	Fuse rating	Circuit Protected
P/SEAT (PASS)	30 A	Passenger Seat Manual Switch
P/SEAT (DRV)	30 A	Driver Seat Manual Switch
AMP	25 A	Low DC–DC Converter (AMP (Amplifier))
P/PWDW RH	25 A	Power Window RH Relay
P/PWDW LH	25 A	Power Window LH Relay, Driver Safety Power Window Module
WIPER RR	15 A	Rear Wiper Motor, ICM (Integrated Circuit Module) Relay Box (Rear Wiper Relay)
S/HEATER FRT	20 A	Front Air Ventilation Seat Module, Front Seat Warmer Module
SUNROOF	20 A	Sunroof Unit
TAIL GATE OPEN	10 A	Tail Gate Relay
S/HEATER RR	15 A	Rear Seat Warmer Module
MODULE 1	7.5 A	Hazard Switch, Data Link Connector, Passenger Power Window Switch, Power Window Main Switch, Crash Pad Switch, Key Interlock
BRAKE SWITCH	10 A	Stop Lamp Switch, IBU (Integrated Body Control Unit)
DOOR LOCK	20 A	Door Lock Relay, Door Unlock Relay, ICM (Integrated Circuit Module) Relay Box (Two Turn Unlock Relay)
IBU 1	15 A	IBU (Integrated Body Control Unit)
START	7.5 A	[With B/Alarm & Without Smart Key] ICM (Integrated Circuit Module) Relay Box (Burglar Alarm Relay) [DCT] Transaxle Range Switch, [IVT] Position Switch
WIPER FRT 1	10 A	IBU (Integrated Body Control Unit)
AIR BAG 2	10 A	SRS (Supplemental Restraint System) Control Module
MEMORY 2	10 A	A/C Control Module, Head-Up Display

7

Fuse Name	Fuse rating	Circuit Protected
MULTI MEDIA	15 A	Low DC-DC Converter
IG1	25 A	PCB Block (Fuse Name - ABS 3, ECU 5, SENSOR 4, TCU 2)
MODULE 4	7.5 A	Forward Collision-Avoidance Assist Unit, IBU (Integrated Body Control Unit), Crash Pad Switch, 4WD ECM (Engine Control Module), Electric Parking Brake Switch, Lane Keeping Assist Unit
HAETED MIRROR	10 A	ECM (Engine Control Module), A/C Control Module, Driver/Passenger Power Outside Mirror
ISG	15 A	Sound Mood Lamp, Driver/Passenger Door Mood Lamp, Low DC-DC Converter, Blind-Spot Collision Warning Unit LH/RH, A/V & Navigation Head Unit, Audio, A/C Control Module, Head-Up Display, Instrument Cluster
IBU2	7.5 A	IBU (Integrated Body Control Unit)
MODULE 5	10 A	Electro Chromic Mirror, Wireless Charger, ATM Shift Lever Indicator, Console Switch LH, Audio, A/V & Navigation Head Unit, A/C Control Module, AMP (Amplifier), Front Air Ventilation Seat Control Module, Rear Seat Warmer Module, Front Seat Warmer Module, Low DC-DC Converter
MODULE 3	7.5 A	Stop Lamp Switch, ATM Shift Lever
AIR BAG	15 A	SRS (Supplemental Restraint System) Control Module, Passenger Occupant Detection Sensor
FRT WIPER2	25 A	PCB Block (Front Wiper (Low) Relay), Front Wiper Motor
MDPS	7.5 A	MDPS (Motor Driven Power Steering) Unit
A/BAG IND	7.5 A	Overhead Console Lamp, Instrument Cluster
CLUSTER	7.5 A	Instrument Cluster, Head-Up Display
A/C 1	7.5 A	Engine Room Junction Block (Blower Relay, PTC Heater #1/#2 Relay), A/C Control Module
POWER OUTLET	20 A	Front Power Outlet #2 (USB), Joint Connector (JM04)
MODULE 2	10 A	Rear USB Charger, IBU (Integrated Body Control Unit), Low DC-DC Converter, Front Power Outlet #2, Power Outside Mirror Switch, ICM (Integrated Circuit Module) Relay Box (Power Outlet Relay), Front USB Charger
MODULE 6	7.5 A	IBU (Integrated Body Control Unit)
A/C 2	10 A	[Auto A/C] Blower Motor, Engine Room Junction Block (Blower Relay) [Manual A/C] Blower Resistor, A/C Control Module
MODULE 7	7.5 A	Front Air Ventilation Seat Module, Front Seat Warmer Module, Rear Seat Warmer Module, Front Deicer Box (Front Deicer LH/RH Relay)
WASHER	15 A	Multifunction Switch

Refer to the following table for a description of the fuse.

Engine Room Junction Block

Fuse	Fuse Name	Fuse rating	Circuit Protected
MULTI FUSE-1	ALT	150 A	Alternator, Engine Room Junction Block (Fuse Name - SGA, EPB 1, EPB 2, ABS 2, 4WD)
		200 A	
	MDPS	80 A	MDPS (Motor Driven Power Steering) Unit
MULTI FUSE-2	B+3	60 A	ICU Junction Block (IPS1, IPS2, IPS3, IPS7, IPS10, IPS13, IPS18, IPS20)
	B+4	60 A	ICU Junction Block (Fuse Name - P/WINDOW LH, P/WINDOW RH, TAILGATE OPEN, SUNROOF, S/HEATER, AMP, P/SEAT (PASS), P/SEAT (DRV))
	B+2	50 A	ICU Junction Block (IPS4, IPS5, IPS6, IPS8, IPS9, IPS11, IPS12, IPS17)
	COOLING FAN1	60 A	Engine Room Junction Block (Cooling Fan 1 Relay)
	B+5	50 A	PCB Block (Main Relay, Fuse Name - ECU 4, ECU 3, B/ALARM HORN, HORN, A/C)
	IG1	40 A	[With Smart Key] Engine Room Junction Block (ACC Relay, IG1 Relay) [Without Smart Key] Ignition Switch
	BLOWER	40 A	Engine Room Junction Block (Blower Relay)
	IG2	40 A	[With Smart Key] Engine Room Junction Block (IG2 Relay, Start Relay) [Without Smart Key] Engine Room Junction Block (Start Relay), Ignition Switch
MULTI FUSE-3	PTC HEATER 1	50 A	Engine Room Junction Block (PTC Heater 1 Relay)
	PTC HEATER 2	50 A	Engine Room Junction Block (PTC Heater 2 Relay)

Fuse	Fuse Name	Fuse rating	Circuit Protected
FUSE	FUEL PUMP	20 A	Engine Room Junction Block (Fuel Pump Relay)
	TCU 1	15 A	TCM (Transmission Control Module)
	EPB 1	60 A	ESC (Electronic Stability Control) Module (With EPB (Electronic parking brake))
	SGA	40 A	Smart Gear Actuator
	EPB 2	40 A	ESC (Electronic Stability Control) Module
	ABS2	30 A	ESC (Electronic Stability Control) Module (Without EPB (Electronic parking brake))
	4WD	20 A	4WD ECM (Engine Control Module)
	COOLING FAN 2	40 A	[Nu 2.0 MPI] Engine Room Junction Block (Cooling Fan 1/2 Relay)
	POWER OUTLET	25 A	ICM (Integrated Circuit Module) Relay Box (Power Outlet Relay)
	VACUUM PUMP	20 A	Vacuum Pump
	B+1	50 A	ICU Junction Block (Long Term Loak Auto Cut Relay, Fuse - BRAKE SWITCH, MODULE 1, IBU 1, S/HEATER RR, AIR BAG 2, DOOR LOCK)
	DCT 1/EOP	40 A	[DCT] TCM (Transmission Control Module) [Nu 2.0 MPI] Electronic Oil Pump Module
	DCT 2	40 A	[DCT] TCM (Transmission Control Module)
	REAR HEATED	30 A	Engine Room Junction Block (Rear Heated Relay)

PCB Block

Fuse Name	Fuse rating	Circuit Protected
ECU1	20 A	PCM (Power Train Control Module)
ECU2	10 A	PCM (Power Train Control Module)
SENSOR1	15 A	Oxygen Sensor (Up/Down)
SENSOR2	10 A	Canister Close Valve, Oil Control Valve #1, Oil Control Valve #2, Oil Control Valve #3, Engine Room Junction Block (Cooling Fan 1/2 Relay), PCB Block (A/C Relay), Purge Control Solenoid Valve, Electronic Thermostat, Variable Intake Solenoid Valve
SENSOR3	10 A	Engine Room Junction Block (Fuel Pump Relay)
IGN COIL	20 A	Ignition Coil #1~#4
A/C	10 A	A/C Relay
B/ALARM HORN	10 A	B/Alarm Horn Relay
INJECTOR	15 A	Injector #1~#4
ECU5	10 A	PCM (Power train Control Module)
ABS3	10 A	ESC (Electronic Stability Control) Module, Data Link Connector
TCU2	15 A	Position Switch
SENSOR 4	15 A	Electronic Oil Pump Module
ECU3	15 A	PCM (Power train Control Module)
ECU4	15 A	PCM (Power train Control Module)
HORN	15 A	Horn Relay

Refer to the following table for the relay type.

Relay NO.	Relay Name	Type
E61	IG1 Relay	MICRO
E63	Fuel Pump Relay	MICRO
E64	Cooling Fan 2 Relay	MICRO
E65	Start Relay	MICRO
E66	IG2 Relay	MICRO
E67	ACC Relay	MICRO
E68	Rear Defogger Relay	MICRO
E69	Cooling Fan 1 Relay	MINI
E70	Blower Relay	MINI
E71	PTC Heater 1 Relay	MICRO
E72	PTC Heater 2 Relay	MICRO

Battery terminal cover*** NOTICE**

Not all fuse panel descriptions in this manual may be applicable to your vehicle. It is accurate at the time of printing. When you inspect the fuse panel in your vehicle, refer to the fuse panel label.

Light bulbs

Light bulbs are installed in various parts of the vehicle to provide lighting inside and outside the vehicle as well as to alert other vehicles.

Bulb replacement precaution

Please keep extra bulbs on hand with appropriate wattage ratings in case of emergencies.

Refer to "Bulb wattage" on page 8-4.

When changing lamps, first turn off the vehicle at a safe place, firmly apply the parking brake and detach the battery's negative (-) terminal.

⚠ WARNING

Working on the lights

Prior to working on the light, firmly apply the parking brake, turn off the ignition switch, and turn off the lights in order to avoid sudden movement of the vehicle and burning your fingers or receiving an electric shock.

Use only bulbs of the specified wattage.

⚠ CAUTION

Light replacement

Be sure to replace the burned-out bulb with one of the same wattage

rating. Otherwise, it may cause damage to the fuse or electric wiring system.

Fully install light bulbs and any parts used to secure them. Failure to do so may result in heat damage, fire, or water entering the headlight unit. This may damage the headlights or cause condensation to build up on the lens. To prevent damage or fire, make sure bulbs are fully seated and locked.

⚠ CAUTION

Headlamp Lens

To prevent damage, do not clean the headlamp lens with chemical solvents or strong detergents.

* NOTICE

- If the light bulb or lamp connector is removed while the lamp is still on, the fuse box's electronic system may log it as a malfunction. Therefore, a lamp malfunction incident may be recorded as a Diagnostic Trouble Code (DTC) in the fuse box.
- It is normal for an operating lamp to flicker momentarily. This is due to a stabilization function of the vehicle's electronic control device. If the lamp lights up normally after momentarily blinking, then it is functioning as normal.

However, if the lamp continues to flicker several times or turns off completely, there may be an error in the vehicle's electronic control device. Please have the vehicle checked by an authorized Kia dealer immediately.

* NOTICE

Have the headlight aiming adjusted by an authorized Kia dealer after an accident or after the headlight assembly is reinstalled.

* NOTICE

You can find moisture inside the lens of lamps after a car wash or driving in the rain. It is a natural event caused by the temperature difference between the inside and the outside of the lamp and does not mean there is a problem with its functions. The moisture inside the lamp would disappear if you drive the vehicle with the headlamp turned on. However, the level at which the moisture is removed may differ depending on the size/location/condition of the lamp. If the moisture continues to stay inside the lamp, have the vehicle checked by an authorized Kia dealer.

If you don't have the necessary tools, the correct bulbs and the expertise, consult an authorized Kia dealer. In many cases, it is difficult to replace vehicle light bulbs because other parts of the vehicle must be removed before you can get to the bulb. This is especially true if you have to remove the headlamp assembly to get to the bulb(s).

Removing/installing the headlamp assembly can result in damage to the vehicle. If non-genuine parts or substandard bulbs are used, it may lead to blowing a fuse or other wiring damages.

Do not install extra lamps or LEDs to the vehicle. If additional lights are installed, it may lead to lamp malfunctions and flickering. Additionally, the fuse box and other wiring may be damaged.

Light bulb position (Front)

Headlamp - Type A



Headlamp - Type B



Headlamp - Type C

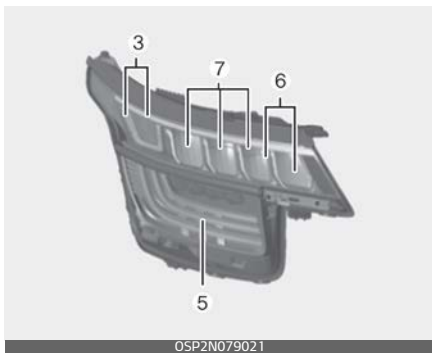

Fog lamp - Type A



Fog lamp - Type B



Front center lamp



- 1. Headlamp (High & Low) (Bulb type)
- 2. Position lamp (Bulb type)

3. Position lamp / Daytime running lamp (LED type)
4. Turn signal lamp (Bulb type)
5. Turn signal lamp (LED type)
6. Headlamp (High) (LED type)
7. Headlamp (Low) (LED type)
8. Front fog lamp (Bulb type)
9. Front fog lamp (LED type)
10. Front center lamp (LED type)

Light bulb position (Rear)

Rear combination lamp – Type A



Rear combination lamp – Type B



License Plate lamp



High Mounted Stop Lamp (HMSL)



1. Tail lamp (Bulb type)
2. Tail lamp / Stop lamp & Side marker lamp (Bulb type)
3. Tail lamp & Stop lamp Side marker lamp (LED type)
4. Tail & Stop lamp (LED type)
5. Back up lamp (Bulb type)
6. Rear turn signal lamp (Bulb type)
7. License plate lamp (Bulb type)
8. High mounted stop lamp (LED type)
9. Side marker lamp (Bulb type)

7

Light bulb position (Side) (if equipped)



1. Side direction indicator lamp (Bulb)
2. Side repeater lamp (LED type)
3. Side marker lamp

Headlamp bulb



⚠ WARNING

Halogen bulbs

Handle halogen bulbs with care.

- Halogen bulbs contain pressurized gas that will produce flying pieces of glass if broken.
- Always handle them carefully, and avoid scratches and abrasions. If the bulbs are lit, avoid contact with liquids. Never touch the glass with bare hands. Residual oil may cause the bulb to overheat and burst when lit. A bulb should be operated only when installed in a headlamp.
- If a bulb becomes damaged or cracked, replace it immediately and carefully dispose of it.
- Wear eye protection when changing a bulb. Allow the bulb to cool down before handling it.

Replacing headlamp (low/high) / turn signal lamp / position lamp (bulb type) (headlamp type A)



1. Headlamp (low and high)
2. Turn signal lamp
3. Position lamp

To prepare replacing the lamp bulb:

1. Open the hood.

To replace the headlamp (low/high) bulb:

1. Remove the headlight bulb cover by turning it counterclockwise.
2. Disconnect the headlight bulb socket-connector.
3. Unsnap the headlight bulb retaining wire by depressing the end and pushing it upward.
4. Remove the bulb from the headlight assembly.
5. Install a new headlight bulb and snap the headlight bulb retaining wire into position by aligning the wire with the groove on the bulb.
6. Connect the headlight bulb socket connector.
7. Install the headlight bulb cover by turning it clockwise.

To replace the turn signal lamp, position lamp:

1. Remove the socket from the assembly by turning the socket counterclockwise until the tabs on the socket align with the slots on the assembly.
2. Insert a new bulb by inserting it into the socket and rotating it until it locks into place.
3. Install the socket in the assembly by aligning the tabs on the socket with the slots in the assembly.
4. Push the socket into the assembly and turn the socket clockwise.

Replacing headlamp (low/high) / turn signal lamp bulb (bulb type) (headlamp type B)



1. Headlamp (low/high)
2. Turn signal lamp

To prepare replacing the lamp bulb:

1. Open the hood.

To replace the headlamp (low/high) bulb:

1. Remove the headlight bulb cover by turning it counterclockwise.

2. Disconnect the headlight bulb socket-connector.
3. Unsnap the headlight bulb retaining wire by depressing the end and pushing it upward.
4. Remove the bulb from the headlight assembly.
5. Install a new headlight bulb and snap the headlight bulb retaining wire into position by aligning the wire with the groove on the bulb.
6. Connect the headlight bulb socket connector.
7. Install the headlight bulb cover by turning it clockwise.

To replace the turn signal lamp:

1. Remove the socket from the assembly by turning the socket counterclockwise until the tabs on the socket align with the slots on the assembly.
2. Insert a new bulb by inserting it into the socket and rotating it until it locks into place.
3. Install the socket in the assembly by aligning the tabs on the socket with the slots in the assembly.
4. Push the socket into the assembly and turn the socket clockwise.

Replacing position lamp / daytime running lamp (LED type) (headlamp type B)

If the position lamp / daytime running lamp LED (1) does not operate, have the vehicle checked by an authorized Kia dealer.



OSP21079178

The LED lamps cannot be replaced as a single component because it is an integrated unit. The LED lamps have to be replaced with the unit.

A skilled technician should check or repair the position lamp / daytime running lamp (LED), for it may damage related parts of the vehicle.

Replacing headlamp (high and low) / position lamp / daytime running lamp / turn signal lamp (LED type) (headlamp type C)

Replacing headlamp (high and low) / position lamp / daytime running lamp / turn signal lamp (LED type) (headlamp type C)

If the position lamp / daytime running lamp LED (1) does not operate, have the vehicle checked by an authorized Kia dealer.



The LED lamps cannot be replaced as a single component because it is an integrated unit. The LED lamps have to be replaced with the unit.

A skilled technician should check or repair the position lamp / daytime running lamp (LED), for it may damage related parts of the vehicle.

Replacing headlamp (high and low) / position lamp / daytime running lamp / turn signal lamp (LED type) (headlamp type C)

Replacing position lamp (auxiliary) (LED type) (if equipped)

If the auxiliary lamp LED (1) does not operate, have the vehicle checked by an authorized Kia dealer



The LED lamps cannot be replaced as a single component because it is an integrated unit. The LED lamps have to be replaced with the unit.

A skilled technician should check or repair the auxiliary lamp (LED), for it may damage related parts of the vehicle.

Replacing front fog lamp (bulb/LED type) (if equipped)

If the front fog lamp (type A, B) does not operate, have the vehicle checked by an authorized Kia dealer.

Type A



Type B



Replacing side repeater lamp (LED type) (if equipped)

If the side repeater lamp LED (1), does not operate, have the vehicle checked by an authorized Kia dealer.



The LED lamps cannot be replaced as a single component because it is an integrated unit. The LED lamps have to be replaced with the unit.

A skilled technician should check or repair the side repeater lamp (LED), for it may damage related parts of the vehicle.

Replacing side repeater lamp bulb (bulb type) (if equipped)



1. Remove the lamp assembly from the vehicle by prying the lens and pulling the assembly out.
2. Disconnect the bulb electrical connector.
3. Separate the socket and the lens parts by turning the socket counterclockwise until the tabs on the socket align with the slots on the lens part.
4. Remove the bulb by pulling it straight out.
5. Insert a new bulb in the socket.
6. Reassemble the socket and the lens part.
7. Connect the bulb electrical connector.
8. Reinstall the lamp assembly to the body of the vehicle.

Replacing front side marker lamp bulb (bulb type) (if equipped)



1. Remove the lamp assembly from the vehicle by prying the cover and pulling the assembly out.
2. Disconnect the bulb electrical connector.
3. Remove the bulb by pulling it straight out.
4. Insert a new bulb in the socket.
5. Connect the bulb electrical connector.
6. Reinstall the lamp assembly to the body of the vehicle.

Replacing front side marker lamp bulb (LED type) (if equipped)

If the front side marker lamp (LED Type) does not operate, have your vehicle checked by an authorized Kia dealer.

Replacing rear turn signal lamp / back up lamp bulb / tail lamp / tail and stop lamp bulb / side marker lamp bulb (bulb type) (rear combination lamp type A, B)

Type A



Type B

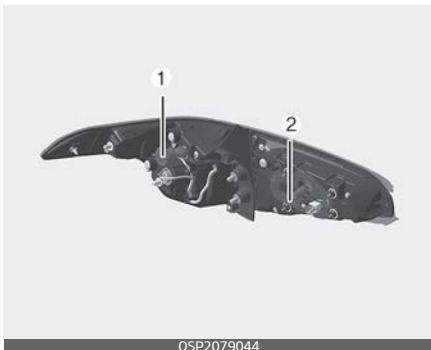

1. Turn signal lamp
2. Back up lamp

3. Tail lamp
4. Tail and stop lamp
5. Side marker lamp

To replace the lamp bulb:

1. Open the liftgate.
2. Loosen the light assembly retaining screws with a cross-tip screwdriver.
3. Remove the rear combination light assembly from the body of the vehicle.
4. Remove the socket from the assembly by turning the socket counterclockwise until the tabs on the socket align with the slots on the assembly.
5. Remove the bulb from the socket by pressing it in and rotating it counterclockwise until the tabs on the bulb align with the slots in the socket.
6. Pull the bulb out of the socket.
7. Insert a new bulb by inserting it into the socket and rotating it until it locks into place.
8. Install the socket in the assembly by aligning the tabs on the socket with the slots in the assembly.
9. Push the socket into the assembly and turn the socket clockwise.
10. Reinstall the light assembly to the body of the vehicle.

Replacing stop lamp / tail and stop lamp & Side marker lamp (LED type) (rear combination lamp type B)

If the stop lamp (1) or tail and stop lamp (2) does not operate, have the vehicle checked by an authorized Kia dealer.



The LED lamps cannot be replaced as a single component because it is an integrated unit. The LED lamps have to be replaced with the unit.

A skilled technician should check or repair the LED lamps, for it may damage related parts of the vehicle.

Replacing High Mounted Stop Lamp bulb (LED type)

If the High Mounted Stop Lamp bulb LED (1) does not operate, have the vehicle checked by an authorized Kia dealer.



Replacing license plate lamp bulb

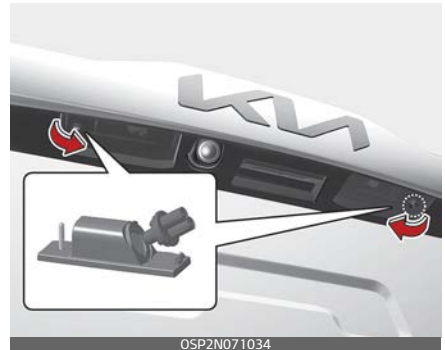

1. Using a screwdriver, gently pry the lamp assembly from interior.
2. Remove the bulb by pulling it straight out.
3. Install a new bulb in the socket.
4. Install the lamp assembly to interior.

Replacing map lamp (bulb/LED type) bulb

If the map lamp bulb (1) does not operate, have the vehicle checked by an authorized Kia dealer.

Bulb type



LED type



The LED lamps cannot be replaced as a single component because they are part of an integrated unit. The LED lamps have to be replaced with the unit.

A skilled technician should check or repair the map lamp (LED), for it may damage related parts of the vehicle.

* NOTICE

Be careful not to damage the lens, lens tab, and plastic housings or get them dirty.

Replacing vanity mirror lamp bulb (if equipped)



⚠ WARNING

Interior lamps

Prior to working on the Interior lamps, ensure that the "OFF" button is depressed to avoid burning your fingers or receiving an electric shock.

1. Using a flat-blade screwdriver, gently pry the lamp assembly from interior.
2. Remove the bulb by pulling it straight out.
3. Install a new bulb in the socket.
4. Install the lamp assembly to interior.

* NOTICE

Be careful not to dirty or damage the lens, lens tab, and plastic housings.

Replacing room lamp (bulb type) bulb (if equipped)

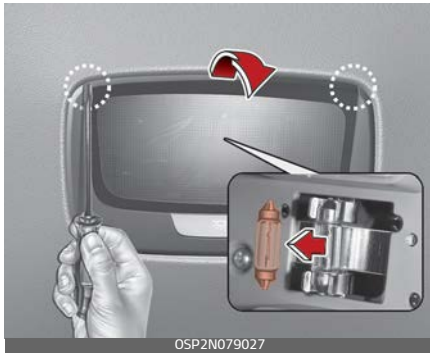

⚠ WARNING

Prior to working on the Interior lamps, ensure that the "OFF" button is depressed to avoid burning your fingers or receiving an electric shock.

1. Using a flat-blade screwdriver, gently pry the lens cover from lamp housing.
2. Remove the bulb by pulling it straight out.
3. Install a new bulb in the socket.
4. Align the lens cover tabs with the lamp housing notches and snap the lens into place.

* NOTICE

Be careful not to dirty or damage the lens, lens tab, and plastic housings.

Replacing room lamp (LED type) bulb (if equipped)

If the Room lamp (LED) does not operate, have the vehicle checked by an authorized Kia dealer.



The LED lamps cannot be replaced as a single component because they are part of an integrated unit. The LED lamps have to be replaced with the unit.

A skilled technician should check or repair the Room lamp (LED), for it may damage related parts of the vehicle.

Replacing glove box lamp (if equipped)



1. Using a flat-blade screwdriver, gently pry the lamp assembly from interior.
2. Remove the bulb by pulling it straight out.
3. Install a new bulb in the socket.
4. Install the lamp assembly to interior.

⚠ CAUTION

Be careful not to damage the lens, lens tab, and plastic housings or get them dirty.

Replacing luggage room lamp (bulb type) bulb



1. Using a flat-blade screwdriver, gently pry the lens cover from lamp housing.
2. Remove the bulb by pulling it straight out.
3. Install a new bulb in the socket.
4. Align the lens cover tabs with the lamp housing notches and snap the lens into place.

⚠ CAUTION

Be careful not to dirty or damage the lens, lens tab, and plastic housings.

Appearance care

Use the information in the following sections to keep the exterior and interior of your vehicle clean.

Exterior care

Use the information in the following sections to maintain the exterior of your vehicle. Keeping the exterior clean is not only aesthetically pleasing, but it also helps to prolong the life of the vehicle.

* NOTICE

If you park the vehicle around a stainless signboard or windshield building etc., the plastic exterior trim (bumper, spoiler, garnish, lamp, outside mirror etc.) may be damaged by reflected sunlight from the external structure. To avoid damaging the plastic exterior trim, park the vehicle away from the areas where the reflected light may occur or use a vehicle cover. (Depending on the vehicle, the type of exterior trim applied such as spoiler may differ.)

Exterior general caution

It is very important to follow the label directions when using any chemical cleaner or polish. Read all warning and caution statements that appear on the label.

Finish maintenance

Washing

To help protect your vehicle's finish from rust and deterioration, wash it thoroughly and frequently at least once a month with lukewarm or cold water.

If you use your vehicle for off-road driving, you should wash it after each off-road trip. Pay special attention to the removal of any accumulation of salt, dirt, mud, and other foreign materials. Make sure the drain holes in the lower edges of the doors and rocker panels are kept clear and clean.

Insects, tar, tree sap, bird droppings, industrial pollution and similar deposits can damage your vehicle's finish if not removed immediately. Even prompt washing with plain water may not completely remove all these deposits. A mild soap, safe for use on painted surfaces, may be used.

After washing, rinse the vehicle thoroughly with lukewarm or cold water. Do not allow soap to dry on the finish.

After washing the vehicle, test the brakes while driving slowly to see if they have been affected by water. If braking performance is impaired, dry the brakes by applying them lightly while maintaining a slow forward speed.

⚠ CAUTION

- Do not use strong soap, chemical detergents or hot water, and do not wash the vehicle in direct sunlight or when the body of the vehicle is warm.
- Be careful when washing the side windows of your vehicle, especially with high-pressure water. Water may leak through the windows and wet the interior.
- To prevent damage to the plastic parts and lamps, do not clean with chemical solvents or strong detergents.

⚠ WARNING

After washing the vehicle, test the brakes while driving slowly to see if they have been affected by water. If braking performance is impaired, dry the brakes by applying them lightly while maintaining a slow forward speed.

High-pressure washing

When using high-pressure washers, make sure to maintain sufficient distance from the vehicle. Insufficient clearance or excessive pressure can lead to component damage or water penetration. Do not spray the camera, sensors or its surrounding area directly with a high pressure washer. Shock applied from high pressure water may

cause the device to not operate normally.

Do not bring the nozzle tip close to boots (rubber or plastic covers) or connectors as they may be damaged if they come into contact with high pressure water.

⚠ CAUTION**Wetting engine compartment**

- Water washing in the engine compartment including high pressure water washing may cause the failure of electrical circuits located in the engine compartment.
- Never allow water or other liquids to come in contact with electrical/ electronic components inside the vehicle as this may damage them.
- After the vehicle has been washed, brake carefully while paying attention to the traffic conditions until the braking effect has been fully restored.

Waxing

Wax the vehicle when water will no longer bead on the paint.

Always wash and dry the vehicle before waxing. Use a good quality liquid or paste wax, and follow the manufacturer's instructions. Wax all metal trim to protect it and to maintain its luster.

Removing oil, tar, and similar materials with a spot remover will usually strip the wax from the finish. Be sure to re-wax these areas even if the rest of the vehicle does not yet need waxing.

Be careful not to touch the lens when waxing the lamps.

CAUTION

Drying vehicle

- Wiping dust or dirt off the body with a dry cloth will scratch the finish.
- Do not use steel wool, abrasive cleaners, acid detergents or strong detergents containing high alkaline or caustic agents on chrome-plated or anodized aluminum parts. This may result in damage to the protective coating and cause discoloration or paint deterioration.

Finish damage repair

Deep scratches or stone chips in the painted surface must be repaired promptly. Exposed metal will quickly

rust and may develop into a major repair expense.

* NOTICE

If your vehicle is damaged and requires any metal repair or replacement, be sure the body shop applies anti-corrosion materials to the parts repaired or replaced.

Bright-metal maintenance

To remove road tar and insects, use a tar remover, not a scraper or other sharp object.

To protect the surfaces of bright metal parts from corrosion, apply a coating of wax or chrome preservative and rub to a high luster.

During winter weather or in coastal areas, cover the bright metal parts with a heavier coating of wax or preservative. If necessary, coat the parts with non-corrosive petroleum jelly or other protective compound.

Underbody maintenance

Road salt and other corrosive chemicals are used in cold weather states to melt snow and prevent ice accumulation. If these chemicals are not regularly removed, they will corrode the vehicle underbody and, over time, damage many parts: the fuel lines, the fuel tank retention sys-

tem, the vehicle's suspension, the exhaust system, and even the body frame.

The National Highway Traffic Safety Administration has warned all vehicle owners of all brands of the need to take the following steps:

- Wash the undercarriage of your vehicle regularly during the winter and whenever your vehicle has been exposed to such salts or chemicals.
- Do a thorough washing of the undercarriage at the end of the winter.
- Use professional service technicians or governmental inspection stations to annually inspect for corrosion.
- Immediately seek an inspection of your vehicle if you become visually aware of corrosion flaking or scaling or if you become aware of a change in vehicle performance, such as soft or spongy brakes, fluids leaking, impairment of directional control, suspension noises or rattling metal straps.

Aluminum wheel maintenance

The aluminum wheels are coated with a clear protective finish.

- Do not use any abrasive cleaner, polishing compound, solvent, or wire brushes on aluminum wheels. They may scratch or damage the finish.

- Clean the wheel when it has cooled.
- Use only a mild soap or neutral detergent, and rinse thoroughly with water. Also, be sure to clean the wheels after driving on salted roads. This helps prevent corrosion.
- Avoid washing the wheels with high speed vehicle wash brushes.
- Do not use any alkaline or acid detergents. It may damage and corrode the aluminum wheels coated with a clear protective finish.

Corrosion protection

Protecting your vehicle from corrosion

By using the most advanced design and construction practices to combat corrosion, we produce vehicles of the highest quality. However, this is only part of the job. To achieve the long-term corrosion resistance your vehicle can deliver, the owner's cooperation and assistance is also required.

Common causes of corrosion

The most common causes of corrosion on your vehicle are:

- Road salt, dirt and moisture that is allowed to accumulate underneath the vehicle.
- Removal of paint or protective coatings by stones, gravel, abra-

sion or minor scrapes and dents which leave unprotected metal exposed to corrosion.

High-corrosion areas

If you live in an area where your vehicle is regularly exposed to corrosive materials, corrosion protection is particularly important. Some of the common causes of accelerated corrosion are road salts, dust control chemicals, ocean air and industrial pollution.

Moisture breeds corrosion

Moisture creates the conditions in which corrosion is most likely to occur. For example, corrosion is accelerated by high humidity, particularly when temperatures are just above freezing. In such conditions, the corrosive material is kept in contact with the vehicle's surface by moisture that evaporates slowly. Mud is particularly corrosive because it dries slowly and holds moisture in contact with the vehicle. Although the mud appears to be dry, it can still retain the moisture and promote corrosion.

High temperatures can also accelerate corrosion of parts that are not properly ventilated so the moisture can be dispersed. For all these reasons, it is particularly important to keep your vehicle clean and free of mud or accumulations of other materials. This applies not only to the visible surfaces but particularly to the underside of the vehicle.

To help prevent corrosion

You can help prevent corrosion from the beginning by observing the following:

Keep your vehicle clean

The best way to prevent corrosion is to keep your vehicle clean and free of corrosive materials. Attention to the underside of the vehicle is particularly important.

If you live in a high-corrosion area — where road salts are used, near the ocean, areas with industrial pollution, acid rain, etc.—, you should take extra care to prevent corrosion. In winter, hose off the underside of your vehicle at least once a month and be sure to clean the underside thoroughly when winter is over.

When cleaning underneath the vehicle, give particular attention to the components under the fenders and other areas that are hidden from view. Do a thorough job; just dampening the accumulated mud rather than washing it away will accelerate corrosion rather than prevent it. Water under high pressure and steam are particularly effective in removing accumulated mud and corrosive materials.

When cleaning lower door panels, rocker panels and frame members, be sure that drain holes are kept open so that moisture can escape

and not be trapped inside to accelerate corrosion.

Keep your garage dry

Don't park your vehicle in a damp, poorly ventilated garage. This creates a favorable environment for corrosion. This is particularly true if you wash your vehicle in the garage or drive it into the garage when it is still wet or covered with snow, ice or mud. Even a heated garage can contribute to corrosion unless it is well ventilated so moisture is dispersed.

Keep paint and trim in good condition

Scratches or chips in the finish should be covered with "touch-up" paint as soon as possible to reduce the possibility of corrosion. If bare metal is showing through, the attention of a qualified body and paint shop is recommended.

Bird droppings: Bird droppings are highly corrosive and may damage painted surfaces in just a few hours. Always remove bird droppings as soon as possible.

Don't neglect the interior

Moisture can collect under the floor mats and carpeting and cause corrosion. Check under the mats periodically to be sure the carpeting is dry. Use particular care if you carry

fertilizers, cleaning materials or chemicals in the vehicle.

These should be carried only in proper containers and any spills or leaks should be cleaned up, flushed with clean water and thoroughly dried.

Interior care

Use the information in the following sections to maintain the interior of your vehicle.

Interior general precautions

Prevent chemicals such as perfume, cosmetic oil, sun cream, hand cleaner, and air freshener from contacting the interior parts because they may cause damage or discoloration. If they do contact the interior parts, wipe them off immediately. If necessary, use a vinyl cleaner, see product instructions for correct usage.

⚠ CAUTION

Electrical components

Never allow water or other liquids to come in contact with electrical/electronic components inside the vehicle, as this may damage them.

⚠ CAUTION

Leather

When cleaning leather products (steering wheel, seats etc.), use neutral detergents or low alcohol content solutions. If you use high alcohol content solutions or acid/alkaline detergents, the color of the leather may fade or the surface may get stripped off.

Taking care of leather seats

- Vacuum the seat periodically to remove dust and sand on the seat. It will prevent abrasion or damage of the leather and maintain its quality.
- Wipe the natural leather seat cover often with dry or soft cloth.
- Sufficient use of a leather protective may prevent abrasion of the cover and helps maintain the color. Be sure to read the instructions and consult a specialist when using leather coating or protective agents.
- Leather with bright colors (beige, cream beige) is easily contaminated and clear in appearance. Clean the seats frequently.
- Avoid wiping with wet cloth. It may cause the surface to crack.

Cleaning the leather seats

Remove all contaminations instantly. Refer to instructions below for removal of each contaminant.

- Cosmetic products (sunscreen, foundation, etc.)
 - Apply cleansing cream on a cloth and wipe the contaminated point. Wipe off the cream with a wet cloth and remove water with a dry cloth.
- Beverages (coffee, soft drink, etc.)
 - Apply a small amount of neutral detergent and wipe until contaminations do not smear.
- Oil
 - Remove oil instantly with absorbable cloth and wipe with stain remover for natural leather only.
- Chewing gum
 - Harden the gum with ice and remove gradually.

Fabric seat cover (if equipped)

Please clean the fabric seats regularly with a vacuum cleaner in consideration of fabric material characteristics. If they are heavily soiled with beverage stains, etc., use a suitable interior cleaner. To prevent damage to seat covers, wipe off the seat covers down to the seams with a large wiping motion

and moderate pressure using a soft sponge or microfiber cloth.

Velcro closures on clothing or sharp objects may cause snagging or scratches on the surface of the seats.

Make sure not to rub such objects against the surface.

Cleaning the upholstery and interior trim

Vinyl

Remove dust and loose dirt from vinyl with a whisk broom or vacuum cleaner. Clean vinyl surfaces with a vinyl cleaner.

Fabric

Remove dust and loose dirt from fabric with a whisk broom or vacuum cleaner. Clean with a mild soap solution recommended for upholstery or carpets. Remove fresh spots immediately with a fabric spot cleaner. If fresh spots do not receive immediate attention, the fabric can be stained and its color can be affected. Also, its fire-resistant properties can be reduced if the material is not properly maintained. Using anything but recommended cleaners and procedures may affect the fabric's appearance and fire-resistant properties.

Cleaning the lap/shoulder belt webbing

Clean the belt webbing with any mild soap solution recommended for cleaning upholstery or carpet. Follow the instructions provided with the soap. Do not bleach or re-dye the webbing because this may weaken it.

Cleaning the interior window glass

If the interior glass surfaces of the vehicle become fogged (that is, covered with an oily, greasy or waxy film), they should be cleaned with a glass cleaner. Follow the directions on the glass cleaner container.

⚠ CAUTION

Rear window

Do not scrape or scratch the inside of the rear window. This may result in damage of the rear window defroster grid.

Emission control system

The emission control system of your vehicle is covered by a written limited warranty. Please see the warranty information contained in the Warranty & Consumer Information manual in your vehicle.

Your vehicle is equipped with an emission control system to meet all applicable emission regulations. There are three emission control systems, as follows.

1. Crankcase emission control system
2. Evaporative emission control system
3. Exhaust emission control system

In order to assure the proper function of the emission control systems, have your vehicle inspected and maintained by an authorized Kia dealer in accordance with the maintenance schedule in this manual.

Caution for the Inspection and Maintenance Test (With Electronic Stability Control (ESC) system)

- **To prevent the vehicle from misfiring during dynamometer testing, turn the ESC off by pressing the ESC switch.**
- **After dynamometer testing is completed, turn the ESC back on by pressing the ESC switch again.**

1. Crankcase emission control system

The Positive Crankcase Ventilation system is employed to prevent air pollution caused by blow-by gases being emitted from the crankcase. This system supplies fresh filtered air to the crankcase through the air intake hose. Inside the crankcase, the fresh air mixes with blow-by gases, which then pass through the Positive Crankcase Ventilation (PCV) valve into the induction system.

2. Evaporative emission control (including Onboard Refueling Vapor Recovery (ORVR)) system

The evaporative emission control system is designed to prevent fuel vapors from escaping into the atmosphere. (The ORVR system is designed to allow the vapors from the fuel tank to be loaded into a canister while refueling at the gas station, preventing the escape of fuel vapors into the atmosphere.)

Canister

Fuel vapors generated inside the fuel tank are absorbed and stored in the onboard canister. When the engine is running, the fuel vapors absorbed in the canister are drawn into the surge tank through the Purge Control Solenoid Valve.

Purge Control Solenoid Valve (PCSV)

The Purge Control Solenoid Valve (PCSV) is controlled by the Engine Control Module (ECM); when the engine coolant temperature is low during idling, the PCSV closes so that evaporated fuel is not taken into the engine. After the engine warms up during ordinary driving, the PCSV opens to introduce evaporated fuel to the engine.

3. Exhaust emission control system

The exhaust emission control system is a highly effective system which controls exhaust emissions while maintaining good vehicle performance.

Engine exhaust gas precautions (carbon monoxide)

- Carbon monoxide can be present with other exhaust fumes. Therefore, if you smell exhaust fumes of any kind inside your vehicle, have it inspected and repaired immediately. If you ever suspect exhaust fumes are coming into your vehicle, drive it only with all the windows fully open. Have your vehicle checked and repaired immediately.

WARNING

Exhaust

Engine exhaust gases contain carbon monoxide (CO). It is a colorless and odorless gas, which is dangerous and could be lethal if inhaled. Follow the instructions on this page to avoid CO poisoning.

- Do not operate the engine in confined or closed areas (such as garages) any more than what is necessary to move the vehicle in or out of the area.
- When the vehicle is stopped in an open area for more than a short time with the engine running, adjust the ventilation system (as needed) to draw outside air into the vehicle.
- Never sit in a parked or stopped vehicle for any extended time with the engine running.
- When the engine stalls or fails to start, excessive attempts to restart the engine may cause damage to the emission control system.

Operating precautions for catalytic converters

WARNING

Catalytic converter

Keep away from the catalytic converter and exhaust system while the vehicle is running or immediately thereafter. The exhaust and catalytic systems are very hot and may burn you.

WARNING

Fire

- Do not park, idle or drive the vehicle over or near flammable objects, such as grass, vegetation, paper, leaves, etc. A hot exhaust system can ignite flammable items under your vehicle.
- Also, do not remove the heat sink around the exhaust system, do not seal the bottom of the vehicle or do not coat the vehicle for corrosion control. It may present a fire risk under certain conditions.

Your vehicle is equipped with a catalytic converter emission control device.

Therefore, the following precautions must be observed:

- Use only UNLEADED FUEL for gasoline engines.

- Do not operate the vehicle when there are signs of engine malfunction, such as misfire or a noticeable loss of performance.
 - Do not misuse or abuse the engine. Examples of misuse are coasting with the ignition off and descending steep grades in gear with the ignition off.
 - Do not operate the engine at high idle speed for extended periods (5 minutes or more).
 - Do not modify or tamper with any part of the engine or emission control system. All inspections and adjustments must be made by an authorized Kia dealer.
 - Avoid driving with an extremely low fuel level. Running out of fuel could cause the engine to misfire, damaging the catalytic converter.
- Failure to observe these precautions could result in damage to the catalytic converter and to your vehicle. Additionally, such actions could void your warranties.

California perchlorate notice

Perchlorate Material—special handling may apply, See www.dtsc.ca.gov/hazardouswaste/perchlorate.

Notice to California Vehicle Dismantlers: Perchlorate containing materials, such as air bag inflators, seatbelt pre-tensioners and keyless remote entry batteries, must be disposed of according to Title 22 California Code of Regulations Section 67384.10 (a).

Specifications, Consumer information and Reporting safety defects

Dimensions	8-2
Engine	8-2
Gross Vehicle Weight	8-3
Luggage volume	8-3
Air conditioning system	8-3
Bulb wattage	8-4
Tires and wheels	8-6
Recommended lubricants and capacities	8-7
• Recommended SAE viscosity number	8-8
Vehicle Identification Number (VIN)	8-9
Vehicle certification	8-10
Tire specification and pressure label	8-10
Engine Number	8-11
Refrigerant label	8-11
Consumer Assistance (U.S. only)	8-12
Electrical Equipment (U.S. only)	8-14
Reporting Safety Defects (U.S. only)	8-15
Online factory authorized manuals (U.S. only)	8-16

SPECIFICATIONS, CONSUMER INFORMATION AND REPORTING SAFETY DEFECTS

Dimensions

Item			in (mm)
Overall length			172.0 (4,370)
Overall width			70.9 (1,800)
Overall height	With roof rack	205/60 R16	64.0 (1,625)
		215/55 R17	64.2 (1,630)
		235/45 R18	
	Without roof rack	205/60 R16	63.4 (1,610)
		215/55 R17	63.6 (1,615)
		235/45 R18	
Tread	Front	205/60 R16	62.0 (1573.6)
		215/55 R17	61.5 (1561.7)
		235/45 R18	61.3 (1557.7)
	Rear (2WD)	205/60 R16	62.4 (1584.1)
		215/55 R17	61.9 (1572.4)
		235/45 R18	61.7 (1568.4)
	Rear (4WD)	205/60 R16	62.4 (1585.1)
		215/55 R17	62.0 (1573.4)
		235/45 R18	61.8 (1569.5)
Wheelbase			103.5 (2,630)

Engine

Item	(Gasoline) 1.6 T-GDi	(Gasoline) 2.0 MPI
Displacement [cu in (cc)]	97.1 (1,591)	122.0 (1,999)
Bore x Stroke [in (mm)]	3.03 x 3.36 (77 x 85.44)	3.2 x 3.8 (81.0 x 97.0)
Firing order	1-3-4-2	1-3-4-2
No. of cylinders	4, In-line	4, In-line

Gross Vehicle Weight

Item	Gamma 1.6 T-GDi	Nu 2.0 MPI	
	DCT	IVT	
	4WD	2WD	4WD
Gross vehicle weight [lbs. (kg)]	4,245 (1,925)	3,881 (1,760)	4,167 (1,890)

Luggage volume

Item	Gamma 1.6 T-GDi, Nu 2.0 MPI
SAE [cu ft (L)]	26.6 (752)

Air conditioning system

Item	Weight of volume [oz (g)]	Classification
Refrigerant	15.9±0.9 (450 ± 25)	R-1234yf
Compressor lubricant	4.2±0.4 (120±10)	PAG 30

Contact an authorized Kia dealer for more details.

Bulb wattage

		Light bulb	Wattage	Type	
Front	Type A*	Low beam	60	9005	
		High beam	60	9005	
		Position lamps	5	P21/5	
		Turn signal lamps	28	2357NA	
	Type B*	Low beam	60	9005	
		High beam	60	9005	
		Position lamps (2-1)	5.8	LED	
		Daytime running lamps (2-1)	24	LED	
		Turn signal lamps	28	2357NA	
		front center lamp*	1.2	LED	
	Type C*	Low beam	42.3	LED	
		High beam	23.7	LED	
		Position lamps	5.8	LED	
		Daytime running lamps	24	LED	
		Turn signal lamps	15.4	LED	
		front center lamp	1.2	LED	
			Fog lamps (bulb)*	51	9006
			Fog lamps (LED)*	16.9	LED
			Side repeater lamps (bulb) *	5	WY5
			Side repeater lamps (LED) *	0.5	LED
		Side marker lamps (on bumper, bulb)*	5	W5	
		Side marker lamps (on bumper, LED)*	1	LED	

		Light bulb	Wattage	Type
Rear	Type A*	Tail lamps (inside)	5	W5
		Tail lamps (outside)	5	P21/5
		Turn signal lamps	21	P21
		Stop lamps	21	P21/5
		Back up lamps	16	W16
		Side marker lamps	5	W5
	Type B*	Tail lamps (inside)	0.5	LED
		Tail lamps (outside) & side marker lamps	2.3	LED
		Turn signal lamps	21	P21
		Stop lamps (inside)	1.8	LED
		Stop lamps (outside)	9.7	LED
		Back up lamps	16	W16
		License plate lamps	5	W5
		High mounted stop lamps	2.9	LED
Interior	Map lamps (type A)*	10	W10	
	Map lamps (type B)*	2	LED	
	Room lamps (type A)*	10	F10	
	Room lamps (type B)*	2	LED	
	Luggage lamp	10	F10	
	Vanity mirror lamp*	5	F5	
	Glove box lamp*	5	Bulb	

*: if equipped

Tires and wheels

Item	Tire size	Wheel size	Load capacity		Speed capacity		Inflation pressure [psi (kPa)]				Wheel lug nut torque lbf·ft (kgf·m, N·m)
			L1*1	kg	SS*2	km/h	Normal load		Maximum load		
							Front	Rear	Front	Rear	
Full size tire	205/60R16	6.5Jx16	92	630	H	210	33 (230)		33 (230)		79-94 (11~13, 107~127)
	215/55R17	7.0Jx17	94	670	V	240	35 (240)	33 (230)	35 (240)	33 (230)	
	235/45R18	7.5Jx18	94	670	V	240	33 (230)		33 (230)		
Compact size tire (spare tire)	T125/80D16	4.0Tx16	97	730	M	130	4.2 (60/420)				

*1. Load Index

*2. Speed Symbol

* NOTICE

- We recommend that when replacing tires, use the same tires as the originally supplied ones. If not, that affects driving performance.
- When driving in high altitude grades, it is natural for the atmospheric pressure to decrease. Therefore, please check the tire pressure and add more air when necessary. Additionally required tire air pressure per km above sea level: 1.5 psi(10.5 kPa)/km

▲ CAUTION



When replacing tires, use the same size as the ones originally supplied with the vehicle. Using tires of a different size can damage the related parts or make it work irregularly.

Recommended lubricants and capacities

To help achieve proper engine and powertrain performance and durability, use only lubricants of the proper quality.

Using the right lubricants help reduce engine friction and improve fuel efficiency.

These lubricants and fluids are recommended for use in your vehicle.

Lubricant	Volume	Classification
Engine oil ^{*1*2*3} (drain and refill)	(Gasoline) 1.6 T-GDi 4.23 US qt. (4.0 L)	Full synthetic SAE 5W-30 / ACEA A5/B5
 <small>RECOMMENDS RECOMANDE REKOMENDUJET</small> 	(Gasoline) 2.0 MPI 4.23 US qt. (4.0 L)	Full synthetic SAE 0W-20, API SN PLUS/SP or ILSAC GF-6
Dual clutch transmission fluid	(Gasoline) 1.6 T-GDi 1.7~1.8 US qt. (1.6-1.7 L)	Kia Genuine oil - HK D DCTF TGO-10 (SK) - SPIRAX S6 GHDE 70W DCTF (H.K.SHELL) - 7 DCTF HKM (S-OIL)
Intelligent Variable Transmission (IVT) fluid	(Gasoline) 2.0 MPI 7.08 US qt. (6.7 L)	Kia Genuine SP-CVT1
Coolant	(Gasoline) 1.6 T-GDi 6.97 US qt. (6.6 L)	Mixture of antifreeze and water (Ethylene-glycol with phosphate based coolant for cooling device)
	(Gasoline) 2.0 MPI 5.7 US qt. (5.4 L)	
Brake fluid	0.74 US qt. (0.7 L)	SAE J1704 DOT-4 LV, FMVSS 116 DOT-4, ISO 4925 CLASS-6
Fuel	13.2 US gal. (50 L)	-
Rear differential oil (4WD)	0.53 US qt. (0.5 L)	-
Transfer case oil (4WD)	(Gasoline) 1.6 T-GDi 0.53 US qt. (0.5 L)	HYPOID GEAR OIL API GL-5, SAE 75W/85 (SK HCT-5 GEAR OIL 75W/85 or EQUIVALENT)
	(Gasoline) 2.0 MPI 4.22 US qt. (0.4 L)	

*1. Refer to "Recommended SAE viscosity number" on page 8-8.

*2. Requires < API Latest (ILSAC Latest) Full synthetic > grade engine oil.

*3. Requires < API SN PLUS (or above) Full synthetic > grade engine oil.

Recommended SAE viscosity number

CAUTION

Always be sure to clean the area around any filler plug, drain plug, or dipstick before checking or draining any lubricant. This is especially important in dusty or sandy areas and when the vehicle is used on unpaved roads. Cleaning the plug and dipstick areas will prevent dirt and grit from entering the engine and other mechanisms that could be damaged.

Engine oil viscosity (thickness) has an effect on fuel economy and cold weather operating (engine start and engine oil flowability). Lower viscosity engine oils can provide better fuel economy and cold weather performance, however, higher viscosity engine oils are required for satisfactory lubrication in hot weather. Using oils of any viscosity other than those recommended could result in engine damage. When choosing an oil, consider the range of temperature your vehicle will be operated in before the next oil change. Proceed to select the recommended oil viscosity from the chart.

Temperature Range for SAE Viscosity Numbers										
Temperature	°C	-30	-20	-10	0	10	20	30	40	50
	(°F)	-10	0	20	40	60	80	100	120	
(Gasoline) 1.6 T-GDi* ¹		5W-30								
(Gasoline) 2.0 MPI		0W-20								

* 1. Requires <API Latest (ILSAC latest) or ACEA A5/B5, Full synthetic> grade engine oil.



An engine oil displaying this American Petroleum Institute (API) Certification Mark conforms to the International Lubricant Specification Advisory Committee (ILSAC). It is recommended to only use engine oils that uphold this API Certification Mark.

Vehicle Identification Number (VIN)

The Vehicle Identification Number (VIN) is the number used in registering your vehicle and in all legal matters pertaining to its ownership, etc.

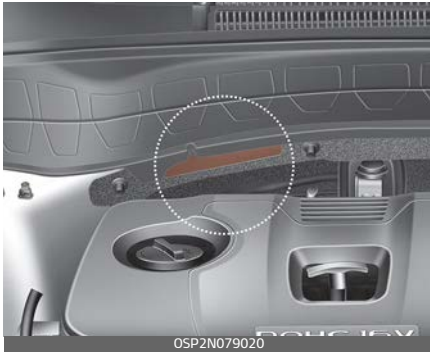

The number is punched on the engine compartment frame as shown in the drawing. To check the number, open the cover.

VIN label (if equipped)



The VIN is also on a plate attached to the top of the dashboard. The number on the plate can easily be seen through the windshield from outside.

Vehicle certification

The vehicle certification label attached on the driver's (or front passenger's) side center pillar gives the Vehicle Identification Number (VIN).



Tire specification and pressure label (if equipped)

The tires supplied on your new vehicle are chosen to provide the best performance for normal driving.



The tire label located on the driver's side center pillar gives the tire pressures recommended for your vehicle.

Engine Number

The engine number is stamped on the engine block as shown in the drawing.

(Gasoline) 1.6 T-GDi



(Gasoline) 2.0 MPI

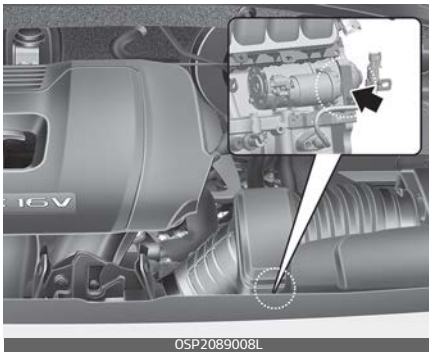

Refrigerant label

The refrigerant label is located on the underside of the hood.



Consumer Assistance (U.S. only)

Roadside Assistance is provided on all new current model year Kia Vehicles from the date the vehicle is delivered to the first retail buyer or otherwise put into use (in-service date), whichever is earlier, for a period of 60 months or 60,000 miles, whichever is earlier, subject to the terms, conditions and exclusions set forth in the Kia Warranty and Consumer Information Manual applicable to your model year vehicle.

Kia America, Inc. reserves the right to limit or deny services or other benefits to any owner or driver when, in Kia America, Inc.'s judgment, the claims and/or service requests are excessive in frequency or type of occurrence.

Toll free consumer assistance

is available from 5:00 AM to 6:00 PM PST, Monday through Friday and is accessible by dialing 1-800-333-4Kia (4542).

For more information regarding assistance available, please refer to your Kia Warranty & Consumer Information Manual.

Emergency roadside assistance

is available 24 hours a day, 365 days a year and is accessible by dialing 1-800-333-4Kia (4542).

Please note that you must provide your Vehicle Identification Number (VIN) to verify coverage at the time of your call. The VIN can be found on the dash of your vehicle on the driver's side, on the door jamb of the driver's door, your vehicle's registration or proof of insurance card.

Kia utilizes a network of over 30,000 roadside assistance providers.

Should you accidentally run out of fuel, require a battery jump, or need help changing a tire, a Kia Roadside Assistance Representative will dispatch someone to deliver a small quantity of gas, change a flat tire with your inflated spare, or arrange a battery jump to allow you to proceed to your destination. We have access to a network of over 10,000 locksmiths to help you should you become locked out of your Kia.

In the event that mechanical difficulty renders your vehicle undrivable due to a warranty-related concern, Kia's Roadside Assistance Representative will arrange to transport your vehicle to the nearest Kia dealer or to an authorized Kia alternative service location.

Your vehicle must be accessible to our dispatch transport vehicle, as determined by our driver, to receive this service.

* NOTICE

Roadside Assistance benefits are not available for any Kia vehicle that has ever been or should have been issued a "salvage" title or similar "branded" title under any state's law or has been declared a "total loss" or equivalent by a financial institution or insurance company.

Trip interruption

Trip interruption expense benefits are provided in the event that a warranty-related disablement occurs more than 150 miles from your home, and the repairs require more than 24 hours to complete. Reasonable reimbursement is included for meals, lodging, or rental vehicle expenses. Trip interruption coverage is limited to \$100 per day subject to a three day maximum limit per incident. You must contact the Kia Roadside Assistance Center to obtain pre-authorization of expenses. Once the Kia Roadside Assistance Center gives authorization for trip interruption benefits, they will assist you in making the necessary arrangements. Insurance deductibles, expenses, and claims

paid by your insurance company or other providers are not eligible for reimbursement.

Fleet vehicles are excluded from reimbursement under Kia's Trip Interruption Policy.

Registering your vehicle in a foreign country

If you plan to register your vehicle in a foreign country, you should confirm that it conforms to the regulations in that country. Even if you successfully register the vehicle in a foreign country, you may experience the following problems and should therefore consider the possibility of having to deal with them:

1. The fuel specified for your vehicle may be unavailable. If other than the specified fuel is used, it could cause damage to the engine, the fuel injection system, and other fuel-related parts which may not be covered under your New Vehicle Emissions Limited Warranty.
2. We must, therefore, clearly state that when you leave the country in which you purchased your Kia new and register it in another country, problems arising from the use of fuel other than the specified fuel are not subject to manufacturer's warranty. Because vehicles like yours may not be marketed in the new country of registration, parts, servic-

ing techniques and tools necessary to maintain and repair your vehicle may be unavailable. Even if vehicles like yours are sold there, mechanical specifications required by the government may vary enough from the country of purchase to cause additional problems.

3. There may not be an Authorized Kia Dealer in the area in which you plan to register your vehicle. You may additionally experience difficulty in obtaining services in a foreign country for any number of reasons.

Further, we cannot assume any responsibility for problems that result from unsatisfactory service or lack of service outside of the United States.

Electrical Equipment (U.S. only)

The electrical system of your vehicle is designed to perform under all reasonably expected operating conditions.

However, before any additional electrical equipment is installed in your vehicle, consult an Authorized Kia Dealer, in order to ensure that you do not void your warranty.

Certain electrical equipment, or the way in which it is installed, may adversely affect the operation of your vehicle, including such systems as the engine control system, the audio system and the electrical charging system and thus potentially void all or part of your warranty.

We assume no responsibility for any expense you may incur or for any malfunction of your vehicle or any of its components or systems that may result from the installation of additional electrical equipment that is not supplied, or recommended for installation by, Kia.

Installation of a mobile two-way radio system

If a mobile two-way radio system is installed improperly, or if an excessively powerful type of system is used, other electronic systems may be adversely affected. To avoid damage to your vehicle, consult an Authorized Kia Dealer concerning the proper equipment and installation.

Kia vehicles are designed and manufactured to meet or exceed all applicable safety standards.

For your safety, however, we strongly urge you to read and follow all directions in this Owner's Manual, particularly the information under the headings "NOTICE", "CAUTION" and "WARNING".

If, after reading this manual, you have any questions regarding the operation of your vehicle, safety issues and defects, please contact your Kia's toll-free Consumer Assistance hot line as below:
National Consumer Affairs Manager
Kia America, Inc.
P.O. Box 52410
Irvine, CA 92619-2410
1-800-333-4Kia (4542)

Reporting Safety Defects (U.S. only)

If you believe that your vehicle has a defect which could cause a crash or could cause injury or death, you should immediately inform the National Highway Traffic Safety Administration (NHTSA) in addition to notifying Kia America, Inc..

If NHTSA receives similar complaints, it may open an investigation, and if it finds that a safety defect exists in a group of vehicles, it may order a recall and remedy campaign. However, NHTSA cannot become involved in individual problems between you, your dealer, or Kia America, Inc..

To contact NHTSA, you may call the Vehicle Safety Hotline toll-free at 1-888-327-4236 (TTY: 1-800-424-9153); go to <http://www.safercar.gov>; download the SaferCar mobile application; or write to: Administrator, NHTSA, 1200 New Jersey Ave. SE., Washington, DC 20590.

You can also obtain other information about motor vehicle safety from <http://www.safercar.gov>.

Online factory authorized manuals (U.S. only)

The following publications are available on www.KiaTechinfo.com.

Service manual

This manual covers maintenance and recommended procedures for repair to engine and chassis components. It is written for the Journeyman mechanic, but is simple enough for most mechanically inclined owners to understand.

Electrical troubleshooting manual

This manual complements the Service Manual by providing indepth troubleshooting information for each electrical circuit in your vehicle.

Owner's manual

This manual describes the overall features and operating procedures for the vehicle.

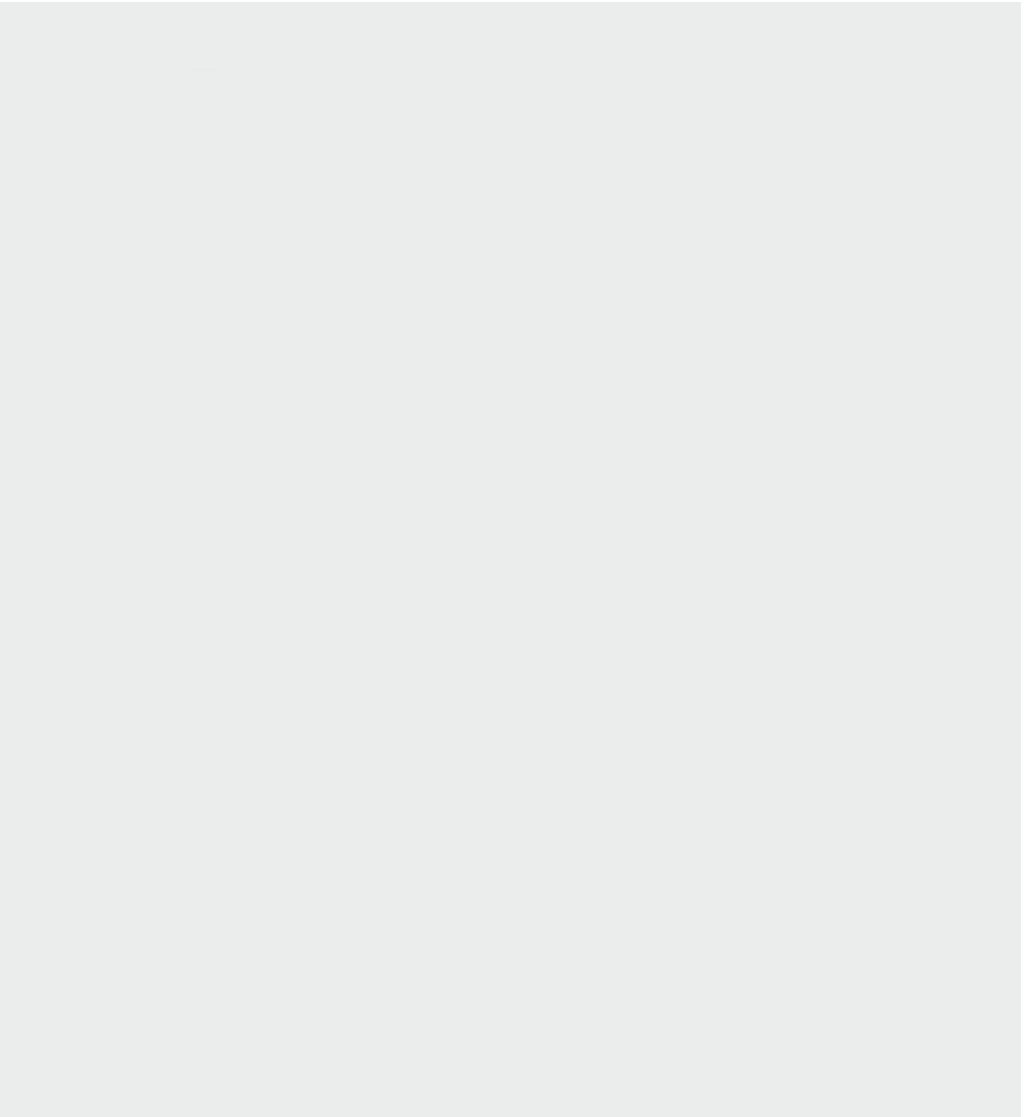

ABBREVIATION

AWD

All Wheel Drive

ABS

Anti-Lock Brake System

ACC

Accessory

ACC

Accessory

ADS

Auto Defogging System

CC

Cruise Control

CO

carbon monoxide

CRS

Child Restraint System

BCW

Blind-Spot Collision Warning

BCA

Blind-Spot Collision-Avoidance Assist

DAW

Driver Attention Warning

DCT

Double Clutch Transmission

DBC

Downhill Brake Control

DRL

Daytime Running Light

DRVM

Driving Rear View Monitor

DTC

Diagnostic Trouble Code

ECM

Electric Chromic Mirror

EDR

Event Data Recorder

EFD

Emergency Fastening Device

EPB

Electronic Parking Brake

EPS

Electronic Power Steering

ESC

Electronic Stability Control

FCA

Forward Collision-Avoidance Assist

FMVSS

Federal Motor Vehicle Safety Standards

FWD

Four Wheel Drive

GPF

Gasoline Particulate Filter

GAW

Gross Axle Weight

GAWR

Gross Axle Weight Rating

Abbreviation

GVW

Gross Vehicle Weight

GVWR

Gross Vehicle Weight Rating

HAC

Hill-start Assist Control

HBA

High Beam Assist

HDA

Highway Driving Assist

HID

High-Intensity Discharge

HMSL

High Mounted Stop Lamp

HUD

Head-Up Display

ISG

Idle Stop and Go

IVT

Intelligent variable transmission

LFA

Lane Following Assist

LKA

Lane Keeping Assist

LNT

Lean NOx Trap

MIL

Malfunction Indicator Lamp

MMT

Methylcyclopentadieny Manganese Tricarbonyl

MPH

Miles Per Hour

NSCC

Navigation-based Smart Cruise Control

ODO

Odometer

ODS

Occupant Detection System

ORVR

Onboard Refueling Vapor Recovery

PCM

Powertrain Control Module

PCSV

Purge Control Solenoid Valve

PCV

Positive Crankcase Ventilation

PDW

Parking Distance Warning

RCCA

Rear Cross-Traffic Collision-Avoidance Assist

ROA

Rear Occupant Alert

RON

Research Octane Number

RPM

Revolution Per Minute

RVM

Rear View Monitor

Abbreviation

SCC

Smart Cruise Control

SEA

Safe Exit Assist

SEW

Safe Exit Warning

SRS

Supplemental Restraint System

SRSCM

SRS Control Module

SUV

Sports Utility Vehicle

TBT

Turn By Turn

TCI

Turbo Charger Intercooler

TCM

Transmission Control Module

TPMS

Tire Pressure Monitoring System

VIN

Vehicle Identification Number

VSM

Vehicle Stability Management

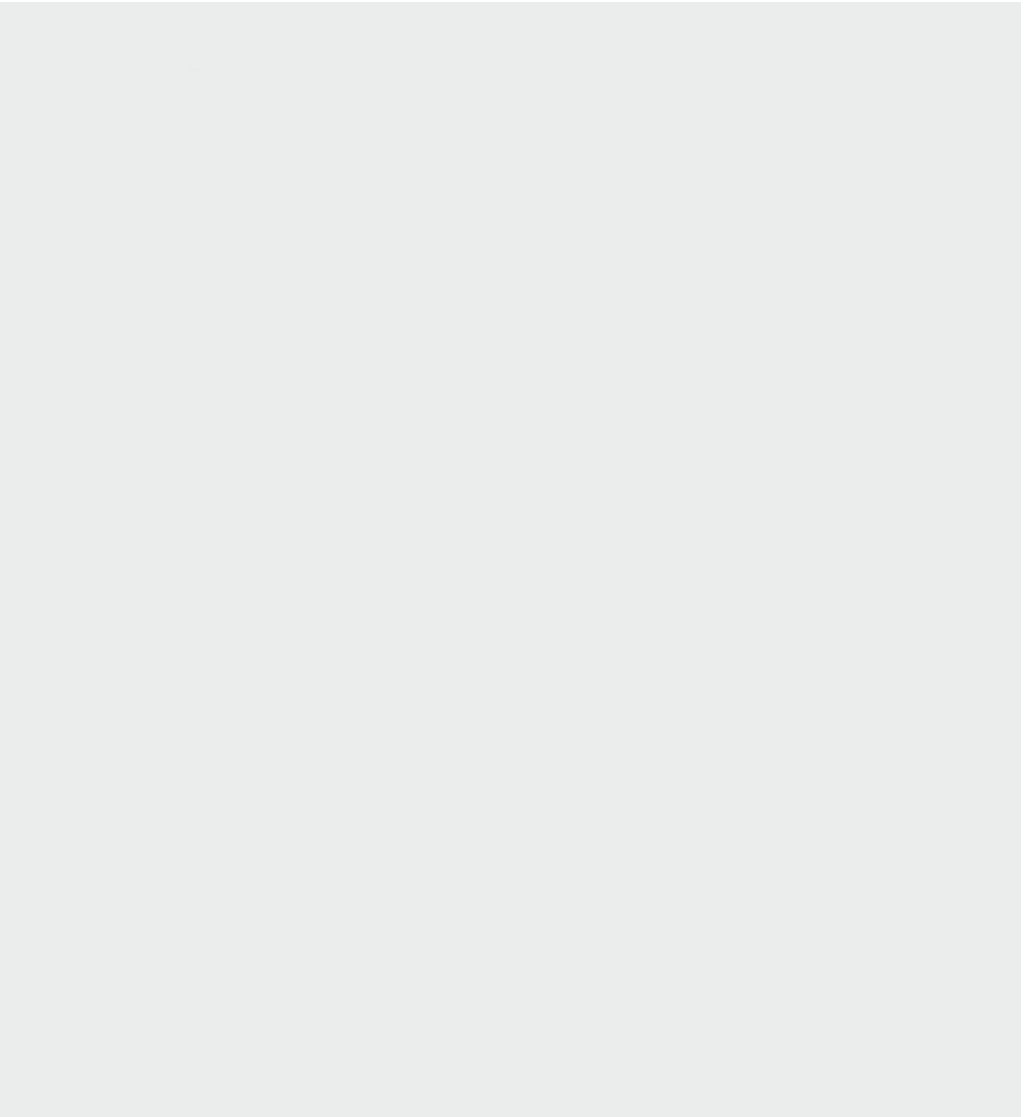

INDEX

A

air bag collision sensors	3-62
air bag warning label	3-68
air bags	3-43
air bag collision sensors	3-62
air bag warning label	3-68
curtain air bag	3-60
driver's and passenger's front air bag	3-56
inflation conditions	3-63
non-inflation conditions	3-65
occupant detection system (ODS)	3-49
operation of the system	3-44
side air bag	3-58
SRS components and functions	3-47
supplemental restraint system (SRS)	3-67
warning light	3-46
air cleaner filter	7-33
air ventilation seat	4-145
All Wheel Drive (AWD) system	5-18
AWD mode	5-19
safe operation	5-21
ambient light	4-141
anti-lock brake system (ABS)	5-54
appearance care	7-83
exterior care	7-83
interior care	7-88
applying the parking brake	5-46
armrest	3-15
ashtray	4-142
audio system	4-156
radio	4-156
USB port	4-156
auto defogging system (ADS)	4-137
auto hold	5-55
applying auto hold	5-55

canceling auto hold	5-56
warning messages	5-57
auto light	4-100
automatic climate control system	4-124
air conditioning	4-130
checking the amount of air conditioner refrigerant and compressor lubricant	4-116
controlling air intake	4-129
controlling fan speed	4-130
heating and air conditioning automatically	4-125
heating and air conditioning manually	4-127
mode selection	4-128
temperature control	4-129
turning off the front air climate control	4-131

B

battery	7-39
for best battery service	7-39
recharging the battery	7-40
reset items	7-41
battery saver function	4-98
before driving	5-8
blind-spot collision-avoidance assist (BCA)	5-113
blind-spot collision-avoidance assist setting	5-115
detecting sensors	5-119
limitations of the blind-spot collision-avoidance assist	5-122
operating conditions	5-116
warning and blind-spot collision avoidance assist control	5-117
brake fluid	7-30
brake system	5-44
anti-lock brake system (ABS)	5-54
auto hold	5-55
downhill brake control (DBC)	5-64
electronic parking brake (EPB)	5-48

electronic stability control (ESC) system	5-58
good braking practices	5-66
hill-start assist control (HAC)	5-63
parking brake (hand type)	5-46
power brakes	5-44
vehicle stability management (VSM) system	5-61
bulb replacement precaution	7-68

C

care of seat belts	3-31
cargo area cover	4-153
center console storage	4-138
check exhaust system	5-7
child restraint system (CRS) types	3-32 3-35
child-protector rear door lock	4-24
cigarette lighter	4-142
climate control air filter	7-34
climate control system	4-113
air conditioning	4-114
air conditioning refrigerant label	4-117
checking the amount of air conditioner refrigerant and compressor lubricant	4-116
climate control air filter heating	4-113
system operation	4-113
ventilation	4-113
closing the hood	4-36
coat hook	4-152
consumer assistance	8-12
cruise control (CC)	5-132
accelerating temporarily with cruise control on	5-134
canceling cruise control	5-134
driving assist button	5-133
increasing cruise control set speed	5-134

resuming cruising speed	5-135
setting cruise control speed	5-133
turning cruise control off	5-135
cup holder	4-143
curtain air bag	3-60

D

day/night rearview mirror	4-50
daytime running light (DRL)	4-99
declaration of conformity FCC	4-159
defogging (windshield)	4-132
defrosting (windshield)	4-132
door lock	4-20
central door lock switch	4-22
child-protector rear door lock	4-24
from inside the vehicle	4-21
from outside the vehicle	4-20
in case of an emergency	4-23
rear occupant alert (ROA) system	4-26
safe exit warning (SEW)	4-24
downhill brake control (DBC)	5-64
drive mode integrated control system	5-71
driver attention warning (DAW)	5-126
driver attention warning malfunction	5-129
driver attention warning setting and operation	5-126
driver's and passenger's front air bag	3-56
driving assist mode	4-60
driving at night	5-184
driving in flooded areas	5-185
driving in the rain	5-185
driving info display	4-71
driving on unpaved roads	5-185
dual clutch transmission (DCT)	5-25

LCD display for transmission temperature and warning message	5-27
operation	5-26
ranges	5-31
shift lock system	5-34
dual clutch transmission shift indicator	4-57

E

economical operation	5-181
electric chromic mirror (ECM)	4-50
electric power steering (EPS)	4-46
electrical equipment	8-14
electronic parking brake (EPB)	5-48
applying the EPB	5-48
automatic application of EPB	5-50
automatic release of EPB	5-50
emergency braking with the EPB switch	5-53
malfunction	5-52
releasing the EPB with EPB switch	5-49
warning	5-51
electronic stability control (ESC) system	5-58
emergency	6-3
hazard warning flasher	6-3
if the engine will not start in case of an emergency	6-5
while driving	6-4
road warning	6-3
emergency starting	6-6
jump-starting	6-6
push-starting	6-7
emission control system	7-91
engine compartment	7-4
engine coolant	7-27
recommended coolant	7-27
engine coolant temperature gauge	4-55

engine oil and filter	7-24
engine overheats	6-8
engine start/stop button	5-13
illuminated engine start/stop button	5-13
position	5-13
starting the engine	5-15
starting the engine with smart key	5-15
exterior features	4-154
roof rack	4-154

F

flat tire	6-16
changing tires	6-18
jack and tools	6-16
jack label	6-25
removing and storing the spare tire	6-18
using of compact spare tire	6-23
floor mat anchor(s)	4-153
forward collision-avoidance assist (FCA) (front view camera only)	5-74
detecting sensor	5-79
forward collision-avoidance assist setting	5-75
forward collision-avoidance assist warning message and brake control	5-77
limitations of forward collision avoidance assist	5-82
prerequisite for activation	5-76
forward collision-avoidance assist (FCA) (sensor fusion)	5-89
forward collision-avoidance assist malfunction and limitations	5-97
forward collision-avoidance assist operation	5-93
forward collision-avoidance assist settings	5-91

forward/reverse parking distance warning (PDW)	4-93	front seat headrest	3-11
non-operational conditions of forward/reverse parking distance warning	4-96	rear seat headrest	3-14
operation of the forward/reverse parking distance warning	4-94	head-up display (HUD)	4-86
self-diagnosis	4-98	heated steering wheel	4-48
front fog light	4-102	high beam assist (HBA)	4-102
front seat adjustment for power seat	3-10	operating high beam assist	4-103
front seat headrest	3-11	highway driving	5-185
fuel filler door	4-37	highway driving assist (HDA)	5-161
fuel gauge	4-55	highway driving assist malfunction	5-165
fuel requirements	1-2	highway driving assist operation	5-163
fuses	7-55	highway driving assist setting and activation	5-162
fuse/relay panel description	7-60	hill-start assist control (HAC)	5-63
replacing engine compartment fuse	7-58	hood	4-35
replacing inner panel fuse	7-57	closing the hood	4-36

G

gauges	4-54	horn	4-49
engine coolant temperature gauge	4-55		
fuel gauge	4-55		
odometer	4-56		
outside temperature gauge	4-56		
speedometer	4-54		
tachometer	4-54		
glove box	4-139		
glove box lamp	4-112		
good braking practices	5-66		

H

hazardous driving conditions	5-182	idle stop and go (ISG)	5-67
head light (low beam)	4-99	deactivating	5-70
headlight (headlamp) escort function	4-113	malfunction	5-70
headrest	3-11	operation	5-69
		illuminated engine start/stop button	5-13
		immobilizer	4-15
		immobilizer system	4-16
		indicator lights	4-82
		inside rearview mirror	4-49
		installing a CRS	3-36
		instrument cluster	4-53
		dual clutch transmission shift indicator	4-57
		engine coolant temperature gauge	4-55
		fuel gauge	4-55
		gauges	4-54

instrument cluster control	4-54
intelligent variable transmission shift indicator	4-57
odometer	4-56
outside temperature gauge	4-56
speedometer	4-54
tachometer	4-54
transmission shift indicator	4-57

intelligent variable transmission (IVT)

operation	5-37
ranges	5-38
shift lock system	5-42

intelligent variable transmission shift indicator

	4-57
--	------

interior features

air ventilation seat	4-145
ambient light	4-141
ashtray	4-142
cargo area cover	4-153
cigarette lighter	4-142
coat hook	4-152
cup holder	4-143
floor mat anchor(s)	4-153
power outlet	4-148
seat warmer	4-144
sound mood lamp	4-141
sun visor	4-146
USB charger	4-146
wireless smart phone charging system	4-149

interior light

automatic turn off function	4-110
glove box lamp	4-112
luggage room lamp	4-111
map lamp	4-110
room lamp	4-111
vanity mirror lamp	4-112

J

jump-starting	6-6
----------------------	-----

K

Key	
immobilizer system	4-15
key	4-7
folding key	4-7
remote keyless entry	4-8
smart key	4-8
key positions	5-10
ignition switch position	5-10
illuminated ignition switch	5-10
starting the engine	5-12

L

lane following assist (LFA)	5-155
caution for the driver	5-159
lane following assist	
malfunction	5-158
limitations of lane following assist	5-159
operating conditions	5-157
warning message	5-158
lane keeping assist (LKA)	5-105
lane keeping assist change	5-107
limitations of lane keeping assist	5-111
to activate/deactivate lane keeping assist	5-106
warning light and message	5-109
LCD display	4-58
LCD display control	4-58
LCD display modes	4-59
LCD display control	4-58
LCD display messages	4-72
LCD display modes	4-59
driving assist mode	4-60
master warning mode	4-61
transmission temperature gauge (for dual clutch transmission)	4-61
trip computer mode	4-60
turn by turn (TBT) mode	4-60
user settings mode	4-61
LCD displays	4-68

driving info display	4-71
LCD display messages	4-72
service mode	4-70
trip information (trip computer)	4-68
leading vehicle departure alert	
function setting	5-131
operating conditions	5-131
liftgate	4-27
light bulbs	
bulb replacement precaution	7-68
lighting	4-98
auto light	4-100
battery saver function	4-98
daytime running light (DRL)	4-99
front fog light	4-102
head light (low beam)	4-99
high beam assist (HBA)	4-102
one-touch lane change	4-101
operating high beam	4-100
operating turn signals	4-101
position and tail lamp	4-99
lights bulbs	7-68
headlamp bulb	7-72
replacing bulbs	7-72
luggage net holder	4-140
luggage room lamp	4-111

M

maintenance	
parking brake	7-32
maintenance services	7-6
owner maintenance precautions	7-7
owner's responsibility	7-6
manual climate control system	4-118
air conditioning	4-123
controlling air intake	4-121
controlling fan speed	4-122
heating and air conditioning	4-119
mode selection	4-120
temperature control	4-121

map lamp	4-110
master warning mode	4-61
mirrors	4-49
adjusting the outside rearview mirrors	4-52
day/night rearview mirror	4-50
electric chromic mirror (ECM)	4-50
folding the outside rearview mirror	4-52
inside rearview mirror	4-49
outside rearview mirror	4-51

N

navigation-based smart cruise control (NSCC)	5-151
displaying the operating conditions	5-152
navigation-based smart cruise control operation	5-152
navigation-based smart cruise control setting	5-151
operating conditions	5-152

O

occupant detection system (ODS)	3-49
odometer	4-56
one-touch lane change	4-101
online factory authorized manuals	8-16
opening the hood	4-35
operating high beam	4-100
outside rearview mirror	4-51
outside temperature gauge	4-56
owner maintenance	7-8

P

parking brake	7-32
applying the parking brake	5-46
releasing the parking brake	5-47

parking brake (hand type)	5-46	rocking the vehicle	5-183
position and tail lamp	4-99	roof rack	4-154
power brakes	5-44	room lamp	4-111
power outlet	4-148		
power window lock button	4-34		
pre-tensioner seat belt	3-27		
push-starting	6-7		

R

rear cross-traffic collision-avoidance assist (RCCA)	5-168
detecting sensor	5-175
limitations of rear cross-traffic collision	5-177
operating conditions	5-171
rear cross-traffic collision setting	5-169
warning and function control	5-171
rear occupant alert (ROA) system	4-26
rear seat headrest	3-14
rear view monitor (RVM)	4-89
reducing the risk of a rollover	5-182
releasing the parking brake	5-47
remote keyless entry	4-8
battery replacement	4-10
operation	4-8
transmitter precautions	4-10
reporting safety defects	8-15
resetting the sunroof	4-44
reverse parking distance warning (PDW)	4-90
non-operational conditions of reverse parking distance warning	4-91
operating condition	4-91
reverse parking distance warning precautions	4-92
self-diagnosis	4-93
risk of burns when parking or stopping vehicle	1-5

S

safe exit warning (SEW)	4-24
safety precautions	3-3
scheduled maintenance items	7-20
air cleaner filter	7-21
air conditioning refrigerant	7-23
brake discs, pads and calipers	7-23
brake fluid	7-23
brake hoses and lines	7-22
checking fluid levels	7-23
coolant	7-21
cooling system	7-21
drive belts	7-20
drive shafts and boots	7-23
dual clutch transmission fluid	7-22
engine oil and filter	7-20
exhaust pipe and muffler	7-23
fuel filter	7-20
fuel lines, fuel hoses and connections	7-21
fuel tank and fuel cap	7-21
intelligent variable transmission (IVT) fluid	7-21
parking brake	7-23
spark plugs	7-21
steering gear box, linkage and boots/ lower arm ball joint	7-23
suspension mounting bolts	7-23
vacuum crankcase ventilation hoses	7-21
valve clearance	7-21
scheduled maintenance service	7-10
maintenance under severe usage conditions	7-14, 7-19
normal maintenance schedule	7-12, 7-16
seat	3-5

armrest	3-15	reducing the risk of a rollover	5-182
folding the rear seat	3-15	rocking the vehicle	5-183
front seat adjustment for manual seat	3-8	smooth cornering	5-184
front seat adjustment for power seat	3-10	specifications	8-2
seat leather	3-8	air conditioning system	8-3
seatback pocket	3-14	bulb wattage	8-4
seat belts	3-19	dimensions	8-2
3-point system with emergency locking retractor	3-22	engine	8-2
care of seat belts	3-31	engine number	8-11
child restraint system (CRS)	3-32	gross vehicle weight	8-3
installing a CRS	3-36	lubricants and capacities	8-7
precautions	3-29	luggage volume	8-3
pre-tensioner seat belt	3-27	refrigerant label	8-11
warning	3-21	tire specification and pressure label	8-10
seat leather	3-8	tires and wheels	8-6
seat warmer	4-144	vehicle certification label	8-10
seatback pocket	3-14	vehicle identification number (VIN)	8-9
service mode	4-70	speedometer	4-54
side air bag	3-58	starting the engine	5-15
sliding armrest	4-139	starting the engine with smart key	5-15
sliding the sunroof	4-43	steering wheel	4-46
smart cruise control (SCC)	5-136	electric power steering (EPS)	4-46
button	5-137	heated steering wheel	4-48
limitations of the function	5-147	horn	4-49
speed	5-138	tilt and telescopic steering	4-47
vehicle-to-vehicle distance	5-142	storage compartment	4-138
smart key	4-12	center console storage	4-138
functions	4-12	glove box	4-139
immobilizer system	4-16	luggage net holder	4-140
smooth cornering	5-184	sliding armrest	4-139
snow tires	5-187	sun visor	4-146
snowy or icy conditions	5-186	sunroof	4-41
sound mood lamp	4-141	resetting the sunroof	4-44
special driving conditions	5-182	sliding the sunroof	4-43
driving at night	5-184	sunroof open warning	4-45
driving in flooded areas	5-185	sunshade	4-42
driving in the rain	5-185	tilting the sunroof	4-42
driving on unpaved roads	5-185	sunroof open warning	4-45
hazardous driving conditions	5-182	sunshade	4-42
highway driving	5-185		

supplemental restraint system (SRS) 3-67

T

tachometer 4-54

theft-alarm system 4-17

armed stage 4-17

disarmed stage 4-19

theft-alarm stage 4-18

tilt and telescopic steering 4-47

tilting the sunroof 4-42

tire and loading information label 5-191

tire chains 5-187

tire pressure indicator 6-10

tire pressure monitoring system (TPMS) 6-10

low tire pressure telltale 6-12

malfunction indicator 6-13

tire pressure indicator 6-10

tire replacement with TPMS 6-14

tires and wheels 7-42

recommended cold tire inflation pressures 7-42

snow tires 7-52

tire chains 7-53

tire maintenance 7-46

tire pressure 7-43

tire replacement 7-45

tire rotation 7-44

tire sidewall labeling 7-46

tire terminology and definitions 7-49

tire traction 7-46

wheel alignment and tire balance 7-44

wheel replacement 7-45

towing 6-26

emergency towing 6-28

removable towing hook 6-28

towing service 6-26

without wheel dollies 6-27

transmission shift indicator 4-57

dual clutch transmission

shift indicator 4-57

intelligent variable transmission shift

indicator 4-57

transmission temperature gauge (for dual clutch transmission) 4-61

trip computer mode 4-60

trip information (trip computer) 4-68

trip modes 4-68

trip modes 4-68

accumulated info display 4-69

digital speedometer 4-70

drive info display 4-70

fuel economy 4-69

turn by turn (TBT) mode 4-60

turn signals 4-101

U

USB charger 4-146

user settings mode 4-61

V

vanity mirror lamp 4-112

vehicle break-in process 1-5

vehicle data collection and event data recorders 1-6

vehicle handling instructions 1-7

vehicle identification number (VIN) 8-9

vehicle load limit 5-191

certification label 5-193

tire and loading information label 5-191

vehicle modifications 1-4

vehicle stability management (VSM) system 5-61

vehicle weight 5-195

W

warning and indicator lights	4-76
indicator lights	4-82
warning lights	4-76
warning lights	4-76
washer fluid	7-31
welcome system	4-113
headlight (headlamp) escort function	4-113
window opening and closing	4-32
windows	4-30
power window lock button	4-34
window opening and closing	4-32
windshield defrosting and defogging	4-132
auto defogging system (ADS)	4-137
defogging logic	4-136
defroster	4-134
front glass heater	4-135
winter driving	5-186
snow tires	5-187
snowy or icy conditions	5-186
tire chains	5-187
wiper blades	7-36
blade inspection	7-36
replacing front windshield wiper blade	7-37
replacing rear window wiper blade	7-38
wipers and washers	4-106
auto control	4-107
auto rear wiper	4-109
operating rear window wiper and washer switch	4-109
operating windshield washer	4-108
windshield washers	4-106
wireless smart phone charging system	4-149

2021 KIA MOTORS AMERICA, INC.



"Printed with soy-based ink on recycled paper. We support a healthy planet and better tomorrow."



Movement that inspires