

2019



Owner's Manual



The Power to Surprise



**WARNING - California
Proposition 65**

“Operating, servicing and maintaining a passenger vehicle or off-road vehicle can expose you to chemicals including engine exhaust, carbon monoxide, phthalates, and lead, which are known to the State of California to cause cancer and birth defects or other reproductive harm. To minimize exposure, avoid breathing exhaust, do not idle the engine except as necessary, service your vehicle in a well-ventilated area and wear gloves or wash your hands frequently when servicing your vehicle. For more information go to www.P65Warnings.ca.gov/passenger-vehicle.”



FOREWORD

Dear Customer,

Thank you for selecting your new Kia vehicle.

As a global car manufacturer focused on building high-quality vehicles with exceptional value, Kia Motors is dedicated to providing you with a customer service experience that exceeds your expectations.

If technical assistance is needed on your vehicle, authorized Kia dealerships factory-trained technicians, recommended special tools, and genuine Kia replacement parts.

This Owner's Manual will acquaint you with the operation of features and equipment that are either standard or optional on this vehicle, along with the maintenance needs of this vehicle. Therefore, you may find some descriptions and illustrations not applicable to your vehicle. You are advised to read this publication carefully and follow the instructions and recommendations. Please always keep this manual in the vehicle for your, and any subsequent owner's, reference.

All information contained in this Owner's Manual was accurate at the time of publication. However, as Kia continues to make improvements to its products, the company reserves the right to make changes to this manual or any of its vehicles at any time without notice and without incurring any obligations.

Please drive safely, and enjoy your Kia vehicle!

© 2018 KIA MOTORS AMERICA, Inc.

All rights reserved. May not be reproduced or translated in whole or in part without the written consent of Kia Motors America, Inc.

Printed in Korea

How to use this manual

We want to help you get the greatest possible driving pleasure from your vehicle. Your Owner's Manual can assist you in many ways.

We strongly recommend that you read the entire manual. In order to minimize the chance of death or injury, you must read the WARNING and CAUTION sections in the manual.

Illustrations complement the words in this manual to best explain how to enjoy your vehicle. By reading your manual, you learn about features, important safety information, and driving tips under various road conditions.

The general layout of the manual is provided in the Table of Contents. Use the index when looking for a specific area or subject, it has an alphabetical listing of all information in your manual.

Chapters: This manual has nine chapters plus an index. Each chapter begins with a brief list of contents so you can tell at a glance if that chapter has the information you want.

You will find various WARNINGS, CAUTIONS, and NOTICES in this manual. These WARNINGS were prepared to enhance your personal safety. You should carefully read and follow ALL procedures and recommendations provided in these WARNINGS, CAUTIONS and NOTICES.

WARNING

A WARNING indicates a situation in which harm, serious bodily injury or death could result if the warning is ignored.

CAUTION

A CAUTION indicates a situation in which damage to your vehicle could result if the caution is ignored.

NOTICE

A NOTICE indicates interesting or helpful information is being provided.

Table of Contents

Electric Vehicle Guide	1
Introduction	2
Your vehicle at a glance	3
Safety features of your vehicle	4
Features of your vehicle	5
Driving your vehicle	6
What to do in an emergency	7
Maintenance	8
Specifications, Consumer information and Reporting safety defects	9
Abbreviation	10
Index	I

Review of Electric Vehicle.....	1-3
Main Components of Electric Vehicle	1-4
• High Voltage (HV) Battery (lithium-ion polymer).....	1-5
EV Menu	1-7
• Available Range.....	1-7
• Energy Information.....	1-8
• Charge Management	1-9
• ECO Driving	1-11
• EV Setting.....	1-12
Charge Types for Electric Vehicle	1-13
• Charging Time Information.....	1-15
Charge Indicator Lamp for Electric Vehicle	1-16
Charging Connector Lock.....	1-17
Reserved Charging.....	1-18
Precautions for Charging Electric Vehicle.....	1-19
Charging Electric Vehicle (AC Charge)	1-22
• Connecting AC charger	1-22
• Charge Indicator Lamp for Electric Vehicle	1-26
• Disconnecting AC charger	1-27
• How to Disconnect Charging Connector in Emergency..	1-28
• How to Store and Keep the AC Charging Cable	1-28
Charging Electric Vehicle (DC Charge)	1-30
• Connecting DC Charger	1-30
• Disconnecting DC Charger	1-32
Charging Electric Vehicle (Trickle Charge)	1-33
• Setting charging current of Portable Charging Cable	1-33
• Trickle charging.....	1-35

1 Electric Vehicle Guide

- Charging Status Indicator Lamp for Portable Charger .. 1-38
- Disconnecting the Portable Charging Cable
(ICCB: In-Cable Control Box) 1-40
- Disconnecting Charging Connector in Emergency..... 1-41
- Precautions for the Portable Charging Cable
(ICCB: In-Cable Control Box) 1-42
- Actions to be taken for electric vehicle charging issues .. 1-43
- Driving Electric Vehicle 1-43**
- Starting a vehicle 1-43
- Stopping the vehicle 1-44
- Virtual Engine Sound System 1-44
- Distance to Empty..... 1-45
- Power/Charge Gauge 1-46
- State of Charge (SOC) Gauge for High Voltage Battery... 1-47
- Warning message on LCD display 1-48
- 12 V Aux. Battery Saver+ 1-52
- Utility Mode 1-54
- Warning and Indicator Lights
(related to electric vehicle)..... 1-54
- Safety Precautions for Electric Vehicle..... 1-56**

ELECTRIC VEHICLE GUIDE

Review of Electric Vehicle

An electric vehicle is driven using a battery and an electric motor. While general vehicles use an internal combustion engine and gasoline as fuel, electric vehicles use electrical energy that is charged inside the high voltage battery

As a result, electric vehicles are eco-friendly in that they do not require fuel and do not emit exhaust gases.

Characteristics of Electric Vehicles

It is driven using the electrical energy that is charged inside the high voltage battery. This method prevents air pollution since fuel, like gasoline, is not required, negating the emission of exhaust gases.

A high performance electric motor is used in the vehicle as well. Compared to standard, internal combustion engine vehicles, engine noise and vibrations are much more minimal when driving.

When decelerating or driving downhill, regenerative braking is utilized to charge the high voltage battery. This minimizes energy loss and increases the distance to empty.

When the battery charge is not sufficient, AC charge, DC charge and trickle charge are available. (Refer to "Charge Types for Electric Vehicle" on page 1-13.)

* NOTICE

What does regenerative braking do? It uses an electric motor when decelerating and braking and recaptures & transforms kinetic to electrical energy in order to charge the high voltage battery.

Battery Information

The vehicle is composed of a high voltage battery that drives the motor, air conditioner, and an auxiliary battery (12 V) that drives all other 12 V systems.

The auxiliary battery is automatically charged when the vehicle is in the ready () mode or the high voltage battery is being charged.

Main Components of Electric Vehicle



ODEEV018002NR

- (1) **On-Board Charger (OBC):** External device (low speed) to charge the high voltage battery.
- (2) **Inverter:** Transforms direct current into alternating current to supply power to the motor, and transforms alternate current into direct current to charge the high voltage battery.
- (2) **LDC:** Transforms power from the high voltage battery to low voltage (12 V) to supply power to the vehicle (DC-DC).
- (2) **VCU:** Functions as a supervisory controller of electric vehicle
- (3) **Motor:** Uses electrical energy stored inside the high voltage battery to drive the vehicle (functions like an engine in a standard vehicle).
- (4) **Reduction gear:** Delivers rotational force of the motor to the tires at appropriate speeds and torque.

- (5) **High voltage battery (lithium-ion polymer)**: Stores and supplies power necessary for the electric vehicle to operate (12 V auxiliary battery provides power to the vehicle features such as lights and wipers).
- * OBC: On-Board Charger
- * LDC: Low Voltage DC-DC Converter
- * VCU: Vehicle Control Unit

⚠ WARNING

- Do not remove or disassemble high voltage components and high voltage battery connectors and/or wiring (Orange cabling). Also, be careful not to damage high voltage components and the high voltage battery. It may cause serious injury and significantly impact the performance and durability of the vehicle.
- When inspection and maintenance is required for high voltage components and the high voltage battery, have the vehicle inspected by an authorized Kia dealer.

High Voltage (HV) Battery (lithium-ion polymer)

The HV battery powers the vehicle and peripheral devices.



The charge amount of the HV battery may gradually decrease when the vehicle is not driven or charged.

The battery capacity of the HV battery may decrease over time when the vehicle is stored in high temperatures and temporarily in low temperatures.

Distance to empty may vary depending on the driving conditions (cargo, rain, snow, wind, road surfaces), even if the charge amount is the same. The HV battery may expend more energy when driving a fast pace or uphill. These actions may reduce the distance to empty.

The high voltage battery is used when using the air conditioner / heater. This may reduce the distance to empty. Make sure to set moderate temperatures when using the air conditioner / heater and/or use the pre-conditioning prior to departures.

Natural degradation may occur with the high voltage battery depending on the number of years the vehicle was used and/or the number of charging cycles. This will reduce the distance to empty over time.

When the charge capacity and distance to empty keep falling, contact an authorized Kia dealer for inspection and maintenance.

If the vehicle will not be in use for an extended period of time, charge the high voltage battery once every three months to prevent it from discharging. Also, if the charge amount is not enough, immediately charge to full and store the vehicle.

AC charge is recommended to keep the high voltage battery in optimal condition.

If the HV battery is only charged to 80%, and you minimize the number of HV battery charging, you can keep the HV battery performance in optimal condition. (vs charging the HV battery to 100% an/or charging every drive cycle.)

⚠ CAUTION

- Make sure to use a designated charger when charging the HV battery. Using different types of chargers may have a serious impact on vehicle durability.
- Make sure that the HV battery charge gauge does not reach E (Empty). If the vehicle is kept at E (Empty) for a long period, it may damage the high voltage battery and the high voltage battery may have to be replaced depending on the level of degradation.
- If the vehicle is in a collision, contact an authorized Kia dealer to inspect whether the high voltage battery is still connected.

*** NOTICE**

The high voltage battery warmer system operates when the charging connector is connected to the vehicle.

However, the high voltage warmer system may not operate when battery temperature drops below -95 °F (-35 °C).

EV Menu (if equipped)

If you select the "EV" menu at the multimedia system home screen or press the "EV" button on the left side of the air intake control button, you can enter EV menu.

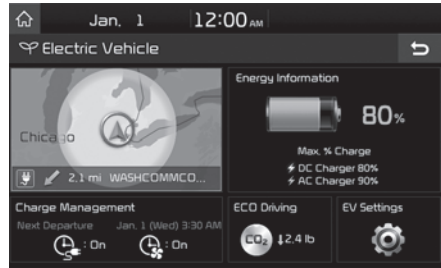

Available Range

Select 'EV → Map' on the screen.



The available range is marked in blue on the map.

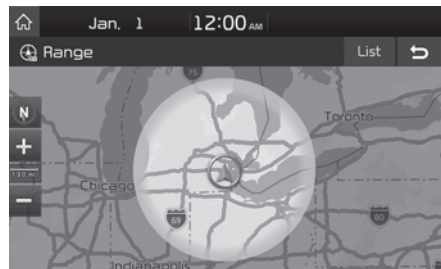

* The image of EV menu screen in this manual may differ from the actual screen depending on the vehicle specification and the version of the multimedia system software. For more information, please refer to the 'CAR MULTIMEDIA SYSTEM USER'S MANUAL'.

The EV menu has a total of 5 menus including Available Range, Energy information, Charge management, ECO driving and EV settings.

Energy Information

Select 'EV → Energy information' on the screen.



You can check information about battery and energy consumption

Battery Information

You can check the reachable range, battery power remaining, and expected charging time for each charger type.



- The distance to empty is calculated based on the real-time fuel efficiency while driving. The distance may change if the driving pattern changes.
- The distance to empty may vary according to the change of the driving pattern even if the same target battery charge level is set.

Power Consumption

Select 'EV → Energy information → Driving range, battery' on the screen.

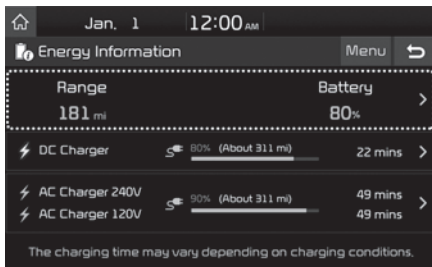

You can check the current energy consumption for each system of the vehicle.

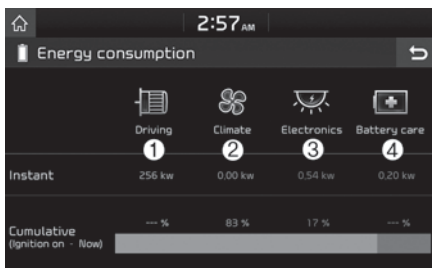

1. 'Driving' shows the total power and energy consumption of the driving motor's driving energy and regenerative energy.
2. 'Climate' shows the power and energy consumption which are used by the heater or air conditioner.
3. 'Electronics' shows the power and energy consumption which are used by the vehicle systems including the cluster, infotainment system (speaker and navigation), headlamp, vehicle control unit, etc.

4. 'Battery care' shows the momentary power and energy consumption which are used when:

Operating the winter mode to increase the battery temperature during winter to improve the driving performance.

Cooling down the battery temperature during summer to prevent over temperature of the battery.

Charge Management

Select 'EV → Charge Management' on the screen.



You can set the date and time of when to charge the battery, climate control temperature, location-based charging options and other various functions.

Reserved Charging and Climate Control

You can choose the time and the day of week that you wish to charge the battery and operate reserved climate control to set the temperature of air conditioner / heater.

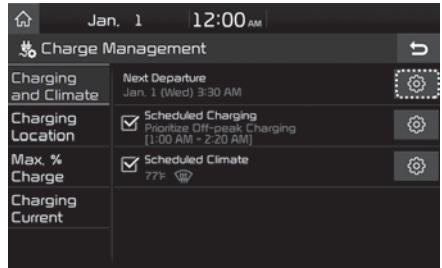

Also, you may select the time to start charging using the off-peak time setting.

* The charger and the charging connector should be connected at the reserved charging time.

Setting Departure Time

You can set the departure time by selecting 'EV → Charge management → Reserved charging and Climate control → Next departure time →' on the screen.

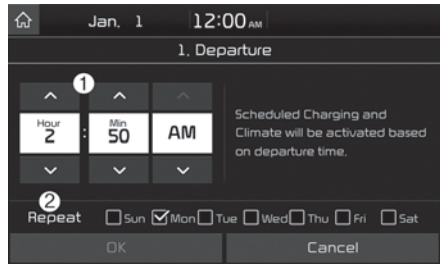
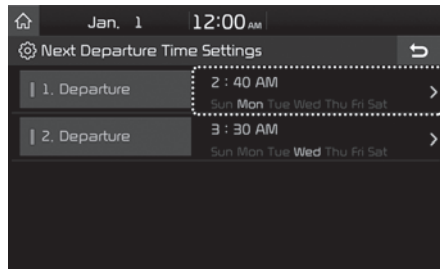

1. Departure time: Set the time that you wish to start the vehicle after charging the battery.
2. Select the day: Set the day of the week to activate reserved charging and target temperature for departure time.

Off-peak Time settings

Select 'EV → Charge management → Reserved charging and Climate Control → Reserved charging →' on the screen.



You can set off-peak time to charge the vehicle.

1. Charging begins at the beginning of the off-peak time
2. Charging stops at the end of the off-peak time
3. Charging mode
 - Off-peak tariffs prioritized: If selected, starts charging at off-peak time (may keep on charging pass off-peak time to charge 100%)
 - Off-peak tariffs only: If selected, charges only within off-peak time (may not charge 100%)

Climate Control Settings

Select 'EV → Charge management → Reserved charging and Climate Control → Reserved climate control →' on the screen.

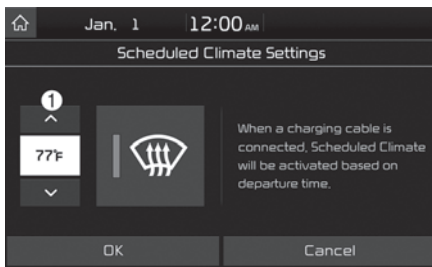

You can set the climate control temperature.

1. Setting the climate control temperature: set the temperature of heater / air conditioner.

Charging Location

If location-based charging is selected, scheduled charging and target temperature will be activated at the location the driver has set.

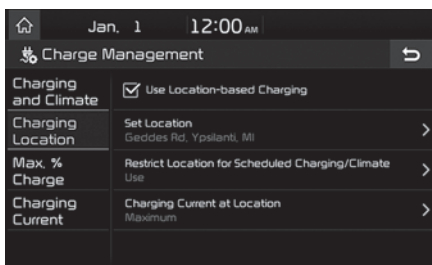

Also, the charging current can be selected to be applied at the designated location.

Setting Battery Charge Level

The target battery charge level can be selected when charged with AC charger or DC charger.

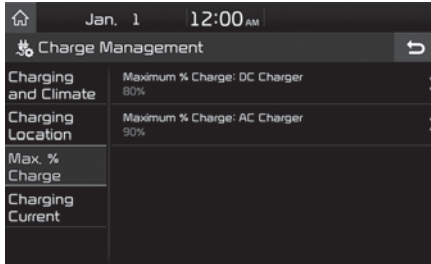

The charging level can be changed by 10%.

If the target battery charge level is lower than the high voltage battery charge level, the battery will not be charged.

Charging Current

You can adjust the charging current for an AC charger. Select an appropriate charging current for the charger used.

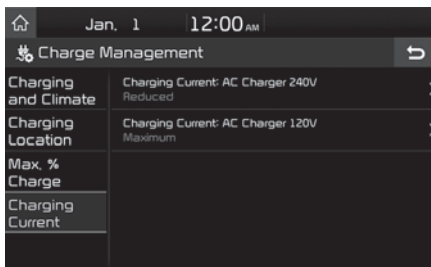

If the charging process does not start or abruptly stops in the middle, re-select another proper current and retry charging the vehicle.

Charging time varies depending on which charging current is selected.

The location-based charging feature allows you to dualize the charging current settings at specific locations.

ECO Driving

Select 'EV → ECO Driving' on the screen.



You can check ECO level information and ECO driving history.

Environment Contribution

Information on CO2 reduction compared to gasoline-fueled vehicles is displayed.

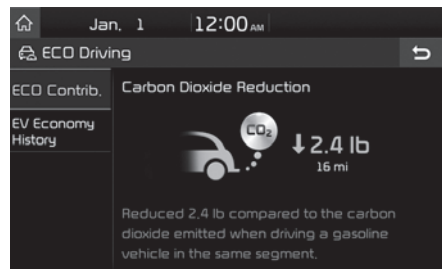

Eco Driving History

You can check the driving date, driving distance, and the average energy consumption rating for the last 30 driving trips.

Eco Driving			
Eco Contrib.	09-19-2014	7 mi	8.3mi/kWh
EV Economy History	09-17-2014	20 mi	9.8mi/kWh
	09-15-2014	16 mi	7.9mi/kWh
	09-12-2014	18 mi	9.3mi/kWh
	09-10-2014	13 mi	8.5mi/kWh

The date with the highest ECO is marked with a star-shaped icon.

EV Setting

Select 'EV → EV Setting' on the screen.



You can set Winter Mode, Warning and EV route functions.

Winter Mode (if equipped)

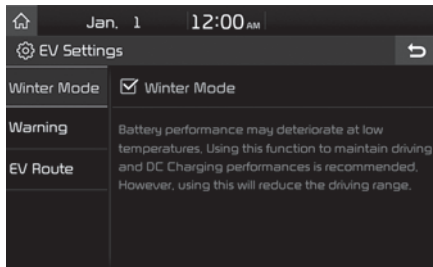

The Winter mode is efficient during the winter time when the high voltage battery temperature is low.

This mode is recommended to improve driving and DC charging performances during winter by raising the battery temperature to an adequate level. However, this may reduce the distance to empty significantly as the high voltage battery consumes a lot more electricity.

Also, if the battery temperature is low during driving or when scheduled air conditioner / heater is activated, this mode is operated to improve driving performance.

However, when the battery level is low, the mode is not operated to ensure driving distance.

* This mode is available for the vehicles equipped with the battery heater.

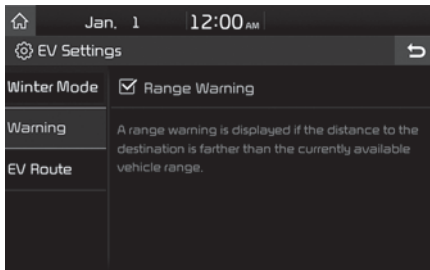
Warning (if equipped)**Range Warning:**

If the destination set in the navigation cannot be reached with the remaining battery, a warning message is displayed.

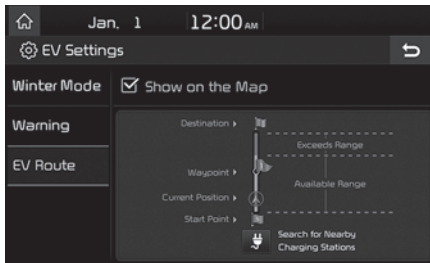
EV Route (if equipped)

You can apply electric car-related functions for guiding the route. It allows you to check the distance that you can go with the current battery amount. Travelable and non-travelable sections on your way to the destination are displayed on the screen. The search station icon is also displayed so that you can find nearby stations immediately.

Charge Types for Electric Vehicle

The types of charging include AC charge, DC charge, and trickle charge.

AC Charge

We recommend using AC charging for charging of the vehicle. You can use a AC charger at public charging stations but charge gun should always be checked for damage, prior to connecting to vehicle. Trickle charging cable (if equipped) in the cargo compartment of your car, can be used, but charge times will be long. (Refer to "Charging Electric Vehicle (AC Charge)" on page 1-22)

DC Charge

You can DC charge at high speeds at public charging stations, but always confirm the charge gun is not damaged, prior to connecting to vehicle. Refer to the respective company's manual that is provided for each DC charger type.

Battery performance and durability can deteriorate if the DC charger is used constantly.

Use of DC charge should be minimized in order to help prolong high voltage battery life.

Trickle Charge







When you cannot drive to a public charging station due to low battery, charge your car with ICCB (In Cable Control Box), a portable charging cable, which can be purchased as an option.

Charging Time Information

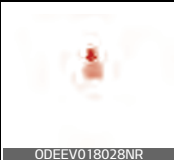
The charging time depends on the charge type.

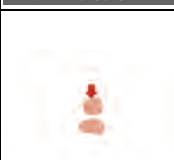
AC charge		Takes about 9 hours and 35 minutes at room temperature. (Can be charged to 100%)
DC charge	100 kW-level charger	Takes about 54 minutes at room temperature to 80% of SOC. (Can be charged to 100%)
	50 kW-level charger	Takes about 75 minutes at room temperature to 80% of SOC. (Can be charged to 100%)
Trickle charge (120 V)		Takes about 59 hours at room temperature. (Can be charged to 100%)

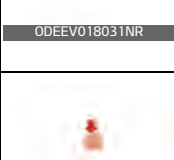
* Depending on the condition and durability of high voltage battery, charger specifications, and ambient temperature, the time required for charging the high voltage battery may vary.

Category	Charging Inlet (Vehicle)	Charging Connector	Charging Outlet	How to Charge	Charging Time
AC Charge	 ODEEV018028NR	 ODEEV018029NR	 ODEEV018030NR	Use the AC charger installed at home or public charging station	Approx. 9 hours and 35 minutes * Can be charged to 100%
DC Charge	 ODEEV018031NR	 ODEEV018105NR	 ODEEV018032NR	Use the DC charger at public charging station	Approx. 54 minutes (100 kW) Approx. 75 minutes (50 kW) * To 80% of SOC, can be charged to 100%
Trickle charge (120 V)	 ODEEV018028NR	 ODEEV018029NR	 ODEEV018033NR	Use household current	Approx. 59 hours * Can be charged to 100%

* Actual charger image and charging method may vary in accordance with the charger manufacturer.

* Depending on the condition and durability of the high voltage battery, charger specifications, and ambient temperature, the time required for charging the high voltage battery may vary.

Charge Indicator Lamp for Electric Vehicle

When charging the high voltage battery, the charge level can be checked from outside the vehicle.



ODEEV018034NR

Operation of Charging Indicator Lamp			Details	
(1)	(2)	(3)		
○ (OFF)	○ (OFF)	○ (OFF)	Not Charged	
Blinking	○ (OFF)	○ (OFF)	Charging	
● (ON)	Blinking	○ (OFF)		0~33%
● (ON)	● (ON)	Blinking		34~66%
● (ON)	● (ON)	Blinking	67~99%	
● (ON)	● (ON)	● (ON)	Charging complete (100%) (turns OFF in 5 seconds)	
Blinking	Blinking	Blinking	Error while charging	
○ (OFF)	○ (OFF)	Blinking	Charging 12 V auxiliary battery or reserved air conditioner is operating	
○ (OFF)	Blinking	○ (OFF)	Reserved charging is operating (turns OFF after 3 minutes) or interruptions that temporarily prevent charging (e.g. power failure)	

Charging Connector Lock

This charging connector lock function prevents an outsider from removing the charging connector from the charging inlet.

Press the  button to change between AUTO mode and LOCK mode.



ODEEV018036NR

* The charging inlet is locked during DC Charge regardless of the AUTO/LOCK mode. After charging is complete, the locked charging inlet is unlocked.

Connector Lock

	LOCK mode	AUTO mode
Before charging (Reserved charging)	0	X
While charging	0	0
Finished charging	0	X

LOCK mode (button indicator off)

The connector locks when the charging connector is plugged into the charging inlet. The connector is locked until all doors are unlocked by the driver. This mode can be used to prevent charging cable theft.

- If the charging connector is unlocked when all doors are unlocked, but the charging cable is not disconnected within 15 seconds, the connector will be automatically locked again.
- If the charging connector is unlocked when all doors are unlocked, but all doors are locked again, immediately, the connector will be automatically locked again.

AUTO mode (button indicator on)

The connector locks when charging starts. The connector unlocks when charging is complete. This mode can be used when charging in a public charging station.

⚠ CAUTION

When using AUTO Mode, close the charging door after unplugging the charging connector and releasing the door lock.

If you close the charging door without releasing the door lock, it may damage lock functions.

Reserved Charging

You can set-up a charging schedule for your vehicle using the multimedia or the UVO application on your smartphone.

Refer to the multimedia system and the UVO manual about reserved charging.

Reserved charging can only be done when using a AC charger or the Portable Charging Cable (ICCB: In-Cable Control Box).

When reserved charging is set and the AC charger or the Portable Charging Cable (ICCB: In-Cable Control Box) is connected for charging, the indicator lamp in the middle blinks (for 3 minutes) to indicate that reserved charging is set.

When reserved charging is set, charging is not initiated immediately when the AC charger or Portable Charging Cable (ICCB: In-Cable Control Box) is connected. When immediate charging is required, use the multimedia system or the UVO application on your smartphone to deactivate the scheduled charging or press the scheduled charging deactivation button

When reserved charging is set, charging time is automatically calculated, so in some cases, charging may start right after the charger is connected.

If you press the scheduled charging deactivation button [⏸ OFF] to immediately charge the battery, charging must be initiated 3 minutes after the charging cable has been connected.



ODEEV018037NR



ODEEV018039NR

When you press the scheduled charging deactivation button  for immediate charging, the reserved charge setting is not completely deactivated. If you need to completely deactivate the reserved charge setting, use the multimedia system or the UVO application on your smartphone.

* Refer to "Charging Electric Vehicle (AC Charge)" on page 1-22, "Charging Electric Vehicle (Trickle Charge)" on page 1-33 for details about connecting the AC charger and the Portable Charging Cable (ICCB: In-Cable Control Box).

Precautions for Charging Electric Vehicle

1

AC Charger

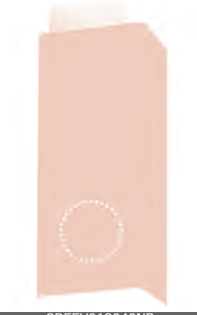

ODEEV018040NR

AC Charging Cable (if equipped)



ODEEV018041NR

DC Charger



ODEEV018042NR

* Actual charger image and charging method may vary in accordance with the charger manufacturer.

⚠ WARNING

- Electromagnetic waves that are generated from the charger can seriously impact medical electric devices such as an implantable cardiac pacemaker.
When using electronic medical devices such as an implantable cardiac pacemaker, make sure to ask the medical team and manufacturer whether charging your electric vehicle will impact the operation of the medical electric devices such as an implantable cardiac pacemaker.
 - Check to make sure there is no water or dust on the charging cable connector and plug before connecting to the charger and charging inlet. Connecting while there is water or dust on the charging cable connector and plug may cause a fire or electric shock.
-

⚠ WARNING

- Be careful not to touch the charging connector, charging plug, and the charging inlet when connecting the charger connector cable to the charging outlet and the charging inlet on the vehicle.
 - Comply with the following in order to prevent electrical shock when charging:
 - Use a waterproof charger.
 - Make sure to not touch the charging connector and charging plug when your hand is wet. Do not stand in water or snow when connecting the charging cable.
 - Do not charge when there is lightning and/or potential for lightning.
 - Do not charge when the charging connector and plug is wet.
-

⚠ WARNING

- Immediately stop charging when you discover abnormal symptoms (e.g., smell, smoke).
- Replace the charging cable if the cable coating is damaged to prevent electrical shock.
- When connecting or removing the charging cable, make sure to hold the charging connector handle.



0DEEV018043NR

- Only use the charging cable (if equipped) certified by Kia. If you use a separate extension cable such as a reel or use an uncertified cable, it may cause abnormalities of electrical outlets, leading to fire or explosion.
- If you pull the cable itself (without using the handle), the internal wires may disconnect or get damaged. This may lead to electric shock or fire.

⚠ CAUTION

- Always keep the charging connector and charging plug in clean and dry condition. Be sure to keep the charging cable in a condition where there is no water or moisture.
- Make sure to use the designated charger for charging the electric vehicle. Using any other charger may cause failure.
- Before charging the battery, turn the vehicle [OFF].
- When the vehicle is switched [OFF] while charging, the cooling fan inside the motor compartment may automatically operate. Do not touch the cooling fan while charging.
- Be careful not to drop the charging connector. The charging connector can be damaged.

Charging Electric Vehicle (AC Charge)

You can use an AC charger at public charging stations and the charging cable (if equipped) in the cargo compartment of your car.

AC Charger



0DEEV018040NR



0DEEV018041NR

* Shape of charger and how to use the charger may be different for each manufacturer.

Connecting AC charger

1. While the brake pedal is pressed, engage the parking brake.
2. Turn OFF all switches, place the shift lever in P (Park), and turn OFF the vehicle.

If you try to charge while the shift lever is not placed in P (Park), it will automatically move to P (Park).

However, charge the battery only when the shift lever is placed in P for safety reasons.

3. Press the arrow symbol [►] on the charging door to open the charging door. The charging door opens only when the vehicle's doors are unlocked.



0DEEV018045NR

⚠ CAUTION

If you cannot open the charging door due to freezing weather, tap lightly or remove any ice near the charging door. Do not try to forcibly open the charging door.

4. Open the charging door remove the AC charging inlet cover (1) to access the AC charging inlet port.



ODEEV018046NR

⚠ CAUTION

In order to connect the charging connector, release the door lock to unlatch the charging connector lock system.

If not, the charging connector and the vehicle's charging inlet may be damaged.

5. Check if there is any dust or foreign substances on the charging connector and charging inlet.
6. Hold the charging connector handle and connect it to the vehicle AC charging inlet.
7. Push the connector until you hear a "clicking" sound. If the charging connector and charging terminal are not connected properly, this may cause a fire.

* For more information about how to charge and how to disconnect, please refer to the manual of each AC charger.

* The shape of the charging connector may be different for each manufacturer.

* Charging Connector AUTO/LOCK Mode

When the charging connector and the charging inlet are connected, you can choose the mode by pressing button. The charging connector will be locked at a different time depending on the selected mode.

- LOCK Mode: When the charging connector is properly connected, the charging connector will be automatically locked.
- AUTO Mode: When the charging connector is properly connected and charging is initiated, the charging connector will be locked.

For more information, refer to the "Charging Connector Lock" on page 1-17.

8. Connect the charging plug to the electric outlet at a AC charging station to start charging.

AC Charger



ODEEV018040NR

9. Check if the charge indicator lamp of the high voltage battery in the instrument cluster is turned ON; Red (plugged in and charging) and OFF (not charging).



ODEEV018047NR

Charging does not occur when the charging indicator lamp is OFF. When the charging connector and charging plug are not connected properly, reconnect the charging cable to charge.

*** NOTICE**

- You can start charging when the POWER button is in the OFF position and the shift lever is in P (Park). After charging has started, you can use electrical components such as the radio by pressing the POWER button to the ACC or ON position.
- If you move the shift lever from P (Park) to R (Reverse), N (Neutral), D (Drive), charging stops immediately. If you want to start charging again, place the shift lever to P (Park) and press the POWER button to the OFF position. Unplug and reconnect the charging cable to start charging again.
- During charging, you cannot move the shift lever from P (parking) to other positions.

10. After charging has started, the estimated charging time is displayed, as well as the charge level, on the instrument cluster for about 1 minute.



* The remaining charging time in the LCD image may differ from actual charging time.

If you open the driver seat door while charging, the estimated charging time is also displayed on the instrument cluster for about 1 minute.

When reserved charging is set, the estimated charging time is displayed as "--".

If air conditioning / remote air conditioning control is set, the estimated time to charge is displayed as "--".

* NOTICE

Depending on the condition and durability of the high voltage battery, charger specifications, and ambient temperature, the time required for charging the battery may vary.

⚠ CAUTION

In order to disconnect the charging connector, release the door lock to unlatch the charging connector lock, if the charge auto lock has not been activate.

If not, the charging connector and the vehicle's charging inlet may be damaged.

Charge Indicator Lamp for Electric Vehicle

When charging the high voltage battery, the charge level can be checked from outside the vehicle.



ODEEV018034NR

Operation of Charging Indicator Lamp			Details	
(1)	(2)	(3)		
○ (OFF)	○ (OFF)	○ (OFF)	Not Charged	
Blinking	○ (OFF)	○ (OFF)	Charging	
● (ON)	Blinking	○ (OFF)		0~33%
● (ON)	● (ON)	Blinking		34~66%
● (ON)	● (ON)	● (ON)	67~99%	
● (ON)	● (ON)	● (ON)	Charging complete (100%) (turns OFF in 5 seconds)	
Blinking	Blinking	Blinking	Error while charging	
○ (OFF)	○ (OFF)	Blinking	Charging 12 V auxiliary battery or reserved air conditioner is operating	
○ (OFF)	Blinking	○ (OFF)	Reserved charging in operation (turns OFF in 3 minutes) or temporary interruptions (e.g., power failure)	

Disconnecting AC charger

1. When charging is complete, remove the charging plug from the electrical outlet.

AC Charger



ODEEV018040NR

2. Hold the charging connector handle and pull it while pressing the release button (1).



ODEEV018049NR

To prevent charging cable theft, the charging connector cannot be disconnected from the inlet when the vehicle's doors are locked. Unlock all doors to disconnect the charging connector from the inlet. However, if the vehicle is in the charging connector AUTO mode, the charging connector automati-

cally unlocks from the inlet when charging is completed.

For more details, refer to "Charging Connector Lock" on page 1-17.

⚠ CAUTION

In order to disconnect the charging connector, release the door lock to unlatch the charging connector lock system.

If not, the charging connector and the vehicle's charging inlet may be damaged.

⚠ CAUTION

Before disconnecting the charging connector, make sure the vehicle's doors are unlocked. When the doors are locked, the charging connector lock release button (1) will not work. When disconnecting the charging connector, do not try to disconnect it by force while not pressing the release button. This may damage the charging connector and vehicle charging inlet.

If the charging connector lock does not unlatch even after the door lock doors have been unlocked, use the emergency release lever in the motor room and press the charging connector lock release button (1) to disconnect the charging connector. If this occurs, the charging connector lock function may have a problem so have your vehicle inspected by an authorized Kia dealer.

3. Make sure to completely close the AC charging inlet cover.

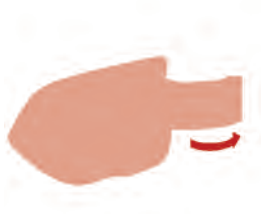

ODEEV018050NR

4. Make sure to completely close the charging door.
5. Close the protective covers of the charging connector and the charging plug to prevent foreign substances from entering the terminals.
6. Store the charging cable safely in the storage compartment

How to Disconnect Charging Connector in Emergency



ODEEV018051NR

If the charging connector does not disconnect due to battery discharge and/or failure of the electric system, open the hood and slightly pull the emergency cable. The charging connector will then disconnect.

How to Store and Keep the AC Charging Cable (if equipped)



ODEEV018052NR

Store the charging cable safely in the storage compartment

⚠ CAUTION

- Do not disassemble or modify the charging Cable (ICCB: In-Cable Control Box). Such acts will void your warranty on the charger, & could result fire, electric shock and injury. shock and injury.
- Always keep the charging connector and charging plug in clean and dry condition. Be sure to keep the charging cable in a condition where there is no water or moisture.
- If there is any foreign substance or dust inside the charging connector and charging plug, blow them off with the air, to prevent damage.
- When the charging connector or charging plug is damaged, corroded or rusted, or if it feels loose when the charging connector and charging plug are connected, do not charge the vehicle and contact an authorized Kia dealer.
- Please note the following when using the charging cable.
 - Do not pull the cable by excessive force.
 - Do not twist or bend it.
 - Do not drag it on the floor.
 - Do not place any object on the cable.
 - Do not place an object that can generate high temperatures near the charger.
 - Do not drop or subject it to shock or impact.
 - Do not store it with liquids.

For cleaning the charging cable, use only a soft cloth like gauze and lightly wipe the surface with water containing a 3% neutral detergent and remove the water with a clean cloth.

Dry it in a well-ventilated shade after wiping off the water. Be careful not to expose the charging connector and charging plug to water.

⚠ CAUTION

When cleaning the charging cable, do not use an organic solvent such as paint thinner, benzene, alcohol and gasoline. Doing so may change the color and damage the charging cable.

When you use a general car cleaner to clean the charging cable, make sure that any organic solvent mentioned above is not included.

Charging Electric Vehicle (DC Charge) (if equipped)

You can charge at high speeds at public charging stations. Use the charging cable installed with DC chargers.

DC Charger



* Actual charger image and charging method may vary in accordance with the charger manufacturer.

* If you use a DC charger when the vehicle is already fully charged, some DC chargers will send out an error message. When the vehicle is fully charged, do not charge the vehicle.

CAUTION

If you cannot open the charging door due to freezing weather, try again after removing any ice near the charging door. If you open it by force, the charging door may be damaged.

Connecting DC Charger

1. While the brake pedal is pressed, engage the parking brake.
2. Turn OFF all switches, place the shift lever in P (Park), and turn OFF the vehicle.

If you try to charge while the shift lever is not placed in P (Park), it will automatically move to P (Park).

However, charge the battery only when the shift lever is placed in P for safety reasons.

3. Press the charging door open symbol [►] to open the charging door.



You cannot open the charging door when the vehicle's doors are locked.

CAUTION

If you cannot open the charging door due to freezing weather, tap lightly or remove any ice near the charging door. Do not try to forcibly open the charging door.

- Open the charging door and then open the cover of the charging inlet.



ODEEV018046NR

- Check whether there is dust or foreign substances inside the charging connector and charging inlet.
- Hold the charging handle and connect it to the vehicle DC charging inlet. Push the connector until you hear a "clicking" sound. If the charging connector and charging terminal are not connected properly, this may cause a fire.
 - * Refer to the manual for each type of DC charger for how to charge and remove the charger.
 - * The shape of the charging connector may vary depending on the manufacturer.

- Check if the charger indicator lamp of the high voltage battery in the instrument cluster is turned ON.



ODEEV018047NR

Charging doesn't start when the charging indicator lamp is OFF. When the charging connector is not connected properly, reconnect the charging cable to charge it again.

⚠ CAUTION

- Charge your car only when the shift lever is placed in P (Park) for safety.
- You can start charging when the POWER button is in the OFF position and the shift lever is in P (Park).

After charging has started, you can use electrical components such as the radio by pressing the POWER button to ACC or ON position.
- You cannot move the shift lever other than P (Park) while charging

⚠ CAUTION

To control the temperature of the high voltage battery while charging, the air conditioner is used to cool down the battery which may generate noise from operation of the air conditioner compressor and cooling fan.

Also, the air conditioner's performance may be degraded during summer due to operation of the cooling system for the high voltage battery.

- 8. After charging has started, the estimated charging time is displayed on the instrument cluster for about 1 minute.

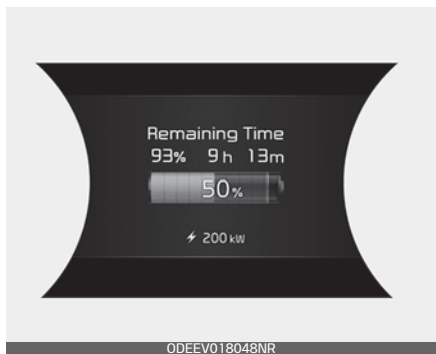

* The remaining charging time in the LCD image may differ from actual charging time.

⚠ CAUTION

Depending on the condition and durability of the high voltage battery, charger specifications, and ambient temperature, the time required for charging the battery may vary.

Disconnecting DC Charger

1. Remove the charging connector when DC charging is completed, or after you stop charging using the DC charger. Refer to each respective fast charger manual for details about how to disconnect the charging connector.

⚠ CAUTION

When disconnecting the charging connector, do not try to disconnect it by force while not pressing the release button. This may damage the charging connector and vehicle charging inlet.

2. Make sure to completely close the DC charging inlet cover.
3. Make sure to completely close the charging door.



Charging Electric Vehicle (Trickle Charge)

When you cannot drive to a public charging station due to low battery, you can charge the car by using the Portable Charging Cable (ICCB: In Cable Control Box) which you can buy as an option.

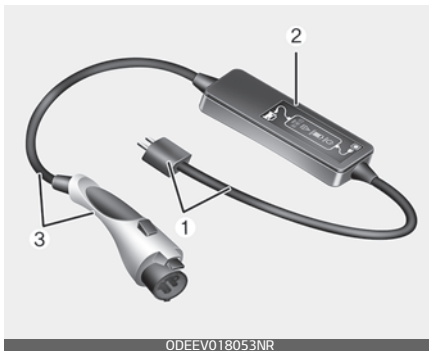

1. Code and Plug (Code set)
2. Control Box
3. Charging Cable and Charging Connector

This cable is designed to prevent problems caused by unexpected battery discharge and when you use general outlets, it may lead to excessive electricity charges as the electricity charges for electric vehicles will not be applied. So refrain from using it to fully charge your car.

If this cable is connected to a household power source, it may exceed the capacity of the outlet (amperage), resulting in safety problems such as electrical shutdown and fire.

Setting charging current of Portable Charging Cable

1. Check the outlet's current rating before connecting the plug to the outlet.
2. Connect the power plug to the household electrical outlet.



ODEEV018113NR

3. Check the status of the control box display

4. Adjust the charging current by pressing the button (1) on the back of the control box for more than 1 second. (Refer to the "" on page 1-34.)

5. Each time the button (1) is pressed, the control box display is sequentially changed to 12 A, 10 A and 8 A.
Once the charging current setting is complete, start charging (refer to "Charging Electric Vehicle (Trickle Charge)" on page 1-33 for more information).



ODEEV018055NR

*** NOTICE**

* Examples of ICCB Charging Current Setting
(Examples are only for reference and situations may vary depending on the surrounding environment.)

Outlet current	ICCB charge level	Control box display
14~16 A	12 A	
13~12 A	10 A	
11~10 A	8 A	
9~8 A	6 A	

ODEEV018056NR

Trickle charging

1. Connect the plug to a household electric outlet.



ODEEV018113NR

⚠ CAUTION

If the outlet is aged, damaged or cracked, do not use it.

2. Check if the power lamp (green) on the control box turns ON.



ODEEV018057NR

3. While the brake pedal is pressed, engage the parking brake.
4. Turn OFF all switches, place the shift lever in P (Park). If you try to charge while the shift lever is not placed in P (Park), it will automatically move to P (Park).

However, charge the battery only when the shift lever is placed in P for safety reasons.

- * Make sure that the plug is not loosely put into the outlet. (If it is loose, it may generate heat.)
5. Press the arrow symbol [▶] on the charging door to open. You cannot open the charging door when the vehicle's doors are locked.



ODEEV018045NR

⚠ CAUTION

If you cannot open the charging door due to freezing weather, tap lightly or remove any ice near the charging door. Do not try to forcibly open the charging door.

⚠ CAUTION

In order to connect the charging connector, unlock the vehicle's doors to unlatch the charging connector lock system.

If not, the charging connector and the vehicle's charging inlet may be damaged.

6. Open the charging door and then open the inlet cover (1).



ODDEEV018046NR

7. Open the protective cover of the charging connector and check if there is dust on the charging connector and charging inlet.

8. Hold the charging connector handle and connect it to the vehicle AC charging inlet.

9. Push the connector until you hear a "clicking" sound. Charging starts automatically and the charging indicator lamp starts to blink.



ODDEEV018058NR

If the charging connector and charging terminal are not connected properly, this may cause a fire.

* Charging Connector AUTO/LOCK Mode

When the charging connector and the charging inlet are connected, you can choose the mode by pressing button. The charging connector will be locked at a different time depending on the selected mode.

- LOCK Mode: When the charging connector is properly connected, the charging connector will be automatically locked.
- AUTO Mode: When the charging connector is properly connected and charging is initiated, the charging connector will be locked, & will unlock when charging has completed.

For more information, refer to the "Charging Connector Lock" on page 1-17.

10. Check if the charge indicator lamp of the high voltage battery in the instrument cluster is turned ON.

Charging does not occur when the charging indicator lamp is OFF.



ODDEEV018047NR

When the charging connector is not connected properly, reconnect the charging cable to charge it again.

* NOTICE

- You can start charging when the POWER button is in the OFF position and the shift lever is in P (Park).
After charging has started, you can use electrical components such as the radio by pressing the POWER button to ACC or ON position.
- If you move the shift lever from P (Park) to R (Reverse), N (Neutral), D (Drive), charging stops immediately. If you want to start charging again, place the shift lever to P (Park) and press the POWER button to the OFF position. Unplug and reconnect the charging cable to start charging again.
- During charging, you cannot move the shift lever from P (parking) to other positions.

11. After charging has started, the estimated charging time is displayed on the instrument cluster for about 1 minute.



* The remaining charging time in the LCD image may differ from actual charging time.

If you open the driver door while charging, the estimated charging time is also displayed on the instrument cluster for about 1 minute.

When reserved charging is set, the estimated charging time is displayed as "--".

* NOTICE











Depending on the condition and durability of the high voltage battery, charger specifications, and ambient temperature, the time required for charging the battery may vary.









⚠ CAUTION

In order to disconnect the charging connector, release the door lock to unlatch the charging connector lock system.

If not, the charging connector and the vehicle's charging inlet may be damaged.

Charging Status Indicator Lamp for Portable Charger

Control Box	Indicator		Details		
	PLUG	 (Green)	On: Power on Blink: Plug temperature sensor failure		
		 (Red)	On: Plug high temperature protection Blink: Plug high temperature warning		
	POWER		On: Power on		
	CHARGE		Blink: Charging In power saving mode, only the CHARGE indicator is illuminated.		
	FAULT		Blink: Charging interrupted		
	CHARGE LEVEL	12A	Charging current 12 A	The charging current changes (3 level) whenever the button (1) is pressed for 1 sec with the charger plugged into an electrical outlet but not the vehicle.	
		10A	Charging current 10 A		
		8A	Charging current 8 A		
	VEHICLE	 (Green)	Charging connector plugged		
		 (Blue)	Charging		
 (Red)		Blink: Charging impossible			

NO	Control Box	Status/Diagnosis /Countermeasure	NO	Control Box	Status/Diagnosis /Countermeasure
1		<ul style="list-style-type: none"> • Connected to power plug (Green On) • Plug temperature sensor failure (Green blink) • Plug high temperature protection (Red blink) • Plug high temperature warning (Red On) (Contact an authorized Kia dealer.)	2		Charging connector plugged into the vehicle (Green On)
3		While charging <ul style="list-style-type: none"> • Charge indicator (Green blink) • Vehicle indicator (Blue ON) 	4		Before plugging charging connector into the vehicle (Red blink) <ul style="list-style-type: none"> • Abnormal internal temperature • Device failure (Contact an authorized Kia dealer.)
5		Plugged into the vehicle (Red blink) <ul style="list-style-type: none"> • Internal diagnostic device failure • Current leakage • Abnormal internal temperature (Contact an authorized Kia dealer.)	6		After plugging charging connector into vehicle (Red blink) <ul style="list-style-type: none"> • Communication failure (Contact an authorized Kia dealer.)
7		<ul style="list-style-type: none"> • Plug temperature sensor failure (Green blink) • Plug high temperature protection (Red blink) • Plug high temperature warning (Red On) (Contact an authorized Kia dealer.)	8		Power saving mode <ul style="list-style-type: none"> • 3 minutes after charging starts (Green blink)

Disconnecting the Portable Charging Cable (ICCB: In-Cable Control Box)

1. Hold the charging connector handle and pull it while pressing the release button (1).



ODEEV018049NR

Before disconnecting the charging connector, make sure the vehicle's doors are unlocked. When the doors are unlocked, the charging connector lock system will be triggered. And the charging connector will not be disconnected. However, in AUTO Mode, the lock is released automatically when charging is completed, and you can disconnect the charging connector.

For more information, refer to the "Charging Connector Lock" on page 1-17.

⚠ CAUTION

In order to disconnect the charging connector, unlock the vehicle's doors to unlatch the charging connector lock system.

If not, the charging connector and the vehicle's charging inlet may be damaged.

⚠ CAUTION

When disconnecting the charging connector, do not try to disconnect it by force while not pressing the release button. This may damage the charging connector and vehicle charging inlet.

- If the charging connector lock does not unlatch even after the vehicle's doors are unlocked, use the emergency release lever in the motor room and press the charging connector lock release button (1) to disconnect the charging connector. If such case occurs, the charging connector lock function may be defective so have your vehicle inspected by an authorized Kia dealer.

2. Make sure to completely close the AC charging inlet cover.



ODEEV018050NR

3. Make sure to completely close the charging door.
4. Disconnect the plug from the household electric outlet. Do not pull the cable when disconnecting the plug.



ODEEV018114NR

5. Close the protective cover for the charging connector so that foreign substances do not flow into the terminal.
6. Put the charging cable inside the cable compartment to protect it.

Disconnecting Charging Connector in Emergency

If the charging connector is not disconnected due to battery discharge and failure of the electrical wires, open the hood and pull the emergency cable and then the charging inlet lock will be released.



ODEEV018051NR

Precautions for the Portable Charging Cable (ICCB: In-Cable Control Box)

WARNING

- Use a portable charging cable that is certified by Kia Motors.
- Do not try to repair, disassemble, or adjust the portable charging cable.
- Do not use an extension cord or adapter.
- Stop using immediately when failure occurs.
- Do not touch the plug and charging connector with wet hands.
- Do not touch the terminal part of the AC charging connector and the AC charging inlet on the vehicle.
- Do not connect the charging connector to voltage that does not comply with regulations.

WARNING

- Do not use the portable charging cable if it is worn out, exposed, or there exists any type of damage on the portable charging cable.
- If the ICCB case and AC charging connector is damaged, cracked, or the wires are exposed in any way, do not use the portable charging cable.

- Do not let kids operate or touch the portable charging cable.
- Charging with a worn out or damaged household electric outlet can result in a risk of electric shock. If you are unsure about the condition of a household electric outlet have it checked by licensed electrician and charge again.
- Stop using the portable charging cable immediately if the household electric outlet or any components are overheating or you notice burning odors.

CAUTION

- Keep the control box free of water.
- Keep the AC charging connector or plug terminal free of foreign substances.
- Do not step on the cable or cord.
- Do not pull the cable or cord and do not twist or bend it. Do not charge when there is lightning.
- Do not drop the control box or place a heavy object on the control box.
- Do not place an object that can generate high temperatures near the charger when charging.

Actions to be taken for electric vehicle charging issues



When you cannot charge the high voltage battery after connecting the charger, check the following:

1. Check the charging settings for the vehicle. → page 9
(e.g. when scheduled charging is set, charging is not initiated immediately when the AC charger or portable charger is connected.)
2. Check the operation status of the AC charger, portable charger and DC charger.
(Status of portable charger → page 38)
* Actual method for indicating the charging status may vary in accordance with the charger manufacturer.
3. When the vehicle does not charge and a warning message appears on the instrument cluster, check the corresponding message. → page 51 ~ page 52
4. If the vehicle is properly charged when charged with another normally working charger, contact the charger manufacturer.
5. If the vehicle does not charge when charged with another normally working charger, we recommend that you contact an authorized Kia dealer for inspection.

Driving Electric Vehicle

This section describes how to start and stop the vehicle, what is displayed on the various gauges and LCD displays, and so on.

Starting a vehicle



1. Holding the smart key, sit in the driver's seat.
2. Fasten the seat belt before starting the vehicle.
3. Make sure to engage the parking brake.
4. Turn OFF all electrical devices.
5. Check the position of the accelerator pedal and the brake pedal and the clearance with your right foot.
6. Make sure to depress and hold the brake pedal.
7. While depressing the brake pedal, shift to P (Park).
8. Depress and hold the brake pedal while pressing the POWER button.
9. When the  indicator is ON, you can drive the vehicle. When the  indicator is OFF, you cannot drive the vehicle. Start the vehicle again.



ODEEV018073NR

10. Depress and hold the brake pedal and shift to the desired position
11. Release the parking brake and slowly release the brake pedal. Check if the vehicle slowly moves forward, then depress the accelerator pedal.

Stopping the vehicle

1. Hold down the brake pedal while the vehicle is parked.
2. While depressing the brake pedal, shift to P (Park).
3. While depressing the brake pedal, engage the parking brake.
4. While depressing the brake pedal, press the POWER button and turn off the vehicle.
5. Check if the  indicator is turned OFF in the instrument cluster. When the  indicator is ON and the gear is in a position other than P (Park), the driver can accidentally depress the accelerator pedal, causing the vehicle to move unexpectedly.



ODEEV018074NR

Virtual Engine Sound System

The Virtual Engine Sound System (VESS) generates an engine sound for pedestrians to hear the vehicle because there is no sound while the Electric Vehicle (EV) is operating.

If the vehicle is in the ready  mode and the gear is not in P (Park), the VESS will operate.

When the gear is shifted to R (Reverse), an additional warning sound will be heard.

CAUTION

The vehicle does not generate an engine sound. Be aware of your driving environment and drive safely. After you park the vehicle or while you are waiting at a traffic light, check whether there are children or obstacles around the vehicle.

⚠ WARNING

The sound system only plays a supplementary role. The system is not designed to and does not replace the care of drivers. Drivers should always pay attention to their surroundings while driving.

Distance to Empty

You can check the distance the vehicle can be driven with the current battery amount.



When destination is not set

Distance to empty may depend on many factors such as the charge amount of the high voltage battery, weather, temperature, durability of the battery, geographical features, and driving style.

Natural degradation may occur with the high voltage battery depending on the number of years the vehicle is used. This may reduce the distance to empty.

On average, a vehicle can drive approximately 239 miles or 385 km. Under certain circumstances where the air conditioner / heater is ON, the distance to empty is impacted, resulting in a possible distance range from 174~310 miles (280~500 km).

When using the heater during cold weather or driving at high speed, the high voltage battery consumes a lot more electricity. This may reduce the distance to empty significantly.

The vehicle can stop shortly after the "---" has been displayed. When it is displayed, drive to a safe place to stop the vehicle. (The available range varies depending on driving speed, heater / air conditioner, weather, driving style, and other factors.)

Distance to empty that is displayed on the instrument cluster after completing a recharge may vary significantly depending on previous operating patterns. When previous driving patterns include high speed driving, resulting in the high voltage battery using more electricity than usual, the estimated distance to empty is reduced. When the high voltage battery uses little electricity in ECO mode, the estimated distance to empty increases.

When destination is set

When the destination is set, the distance to empty may change. The distance to empty is recalculated using the information of the destination.

However, the distance to empty may vary significantly based on traffic conditions, driving habits, and condition of the vehicle.

Tips for Improving Distance to empty

- If you operate the air conditioner / heater too much, the driving battery uses too much electricity. This may reduce the distance to empty. Therefore, it is recommended that you set the cabin temperature to 72 °F (22 °C) AUTO. This setting that has been certified by various assessment tests to maintain optimal energy consumption rates while keeping the temperature fresh. Turn OFF the heater and air conditioner if you do not need them.
- When the heater or air conditioning system is on the energy consumption is reduced if recirculation mode is selected instead of selecting the fresh mode. The fresh mode requires large amount of energy consumption as the outside air has to be re-heated or cooled.
- When using the heater or air conditioning system, use the DRIVER ONLY or scheduled air conditioner / heater function.
- Depress and hold the accelerator pedal to maintain speed and drive economically.
- Gradually depress and release the accelerator pedal when accelerating or decelerating.
- Always maintain specified tire pressures.
- Do not use unnecessary electrical components while driving.
- Do not load unnecessary items in the vehicle.
- Do not mount parts that may increase air resistance.

Power/Charge Gauge

The Power/Charge gauge shows the energy consumption rate of the vehicle and the charge/discharge status of the regenerative brakes.

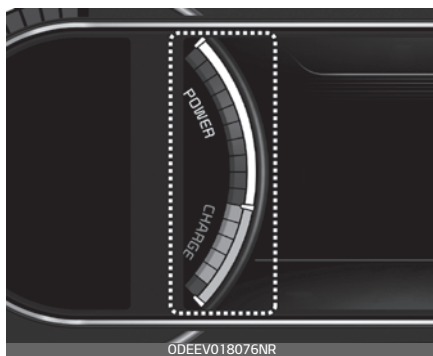

- **POWER:**
It shows the energy consumption rate of the vehicle when driving uphill or accelerating. The more electric energy is used, the higher the gauge level.
- **CHARGE:**
It shows the charging status of the battery when it is being charged by the regenerative brakes (decelerating or driving on a downhill road). The more electric energy is charged, the lower the gauge level.

State of Charge (SOC) Gauge for High Voltage Battery

The SOC gauge shows the charging status of the high voltage battery.

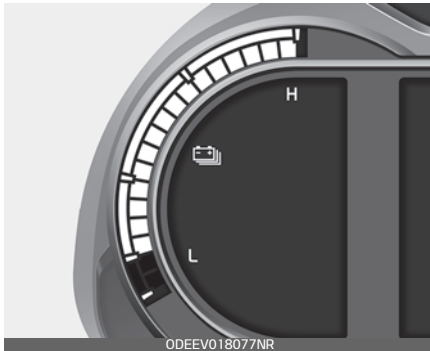

"L (Low)" position on the indicator indicates that there is not enough energy in the high voltage battery.

"H (High)" position indicates that the driving battery is fully charged.

When driving on highways or motorways, make sure to check in advance if the driving battery is charged enough.

1. When there are 2 gauge bars (near the "L (Low)" area) on the SOC gauge, the warning lamp turns ON to alert you of the battery level.



ODEEV018078NR

2. When the warning lamp turns ON, the vehicle can drive an additional 12~18 miles (20~30 km) depending on the driving speed, heater / air conditioner, weather, driving style, and other factors. Charging is required.

⚠ WARNING

When there are 1~2 gauge bars left for the high voltage battery, the vehicle speed is limited and then eventually the vehicle will turn OFF. Charge the vehicle immediately.

Warning message on LCD display

Low battery

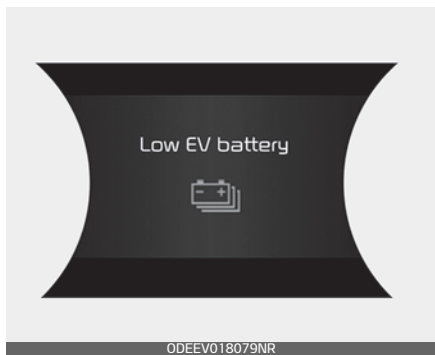

When the high voltage battery level reaches around 8% or less, this warning message is displayed.

The warning light on the instrument cluster (⚡) will turn on simultaneously. Charge the battery immediately.

Charge immediately. Power limited

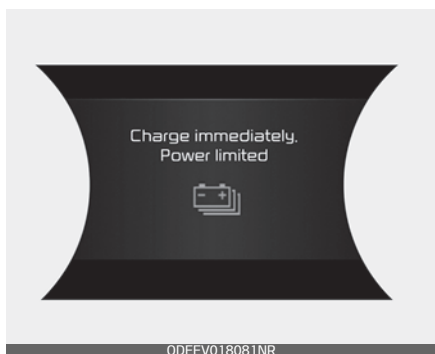

When the high voltage battery level reaches around 3% or less, this warning message is displayed.

The warning light on the instrument cluster (⚡) and the power down warning light (🚗) will turn on simultaneously.

The vehicle's power will be reduced to minimize the energy consumption of the high voltage battery. Charge the battery immediately.

Check electric vehicle system

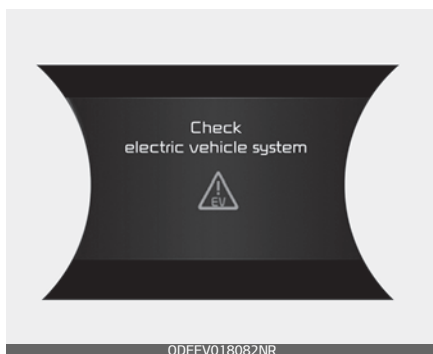

This warning message is displayed when there is a problem with the electric vehicle control system.

⚠ WARNING

Refrain from driving when the warning message is displayed. If this occurs, have your vehicle inspected by an authorized Kia dealer.

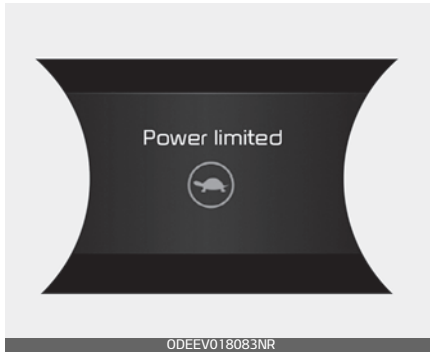
Power limited

In the following cases, this warning message is displayed when the vehicle's power is limited for safety.

- When the high voltage battery is below a certain level, or voltage is decreasing.
- When the temperature of the motor or high voltage battery is too high or too low.
- When there is a problem with the cooling system or a failure that may interrupt normal driving.

⚠ WARNING

When this warning message is displayed, do not accelerate or start the vehicle suddenly.

Charge the battery immediately when the high voltage battery level is not enough.

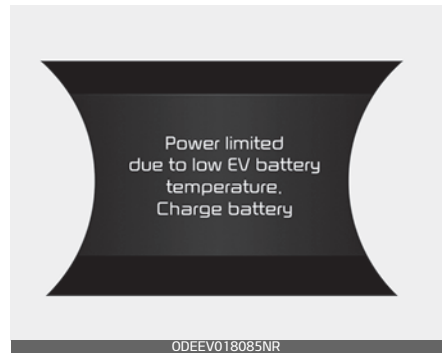
Power limited due to low EV battery temperature. Charge battery

The warning message is displayed to protect the electric vehicle system when you turn off or turn on the vehicle while outside temperature is low. If the high voltage battery charging level is low and parked outside in low temperature for a long time, vehicle power could be limited. Charging the battery before driving, increases the battery temperature, and helps increase power.

⚠ CAUTION

If this warning message is still displayed even when the ambient temperature is sufficiently high, have the vehicle inspected by an authorized Kia dealer.

EV Battery Overheated! Stop vehicle.

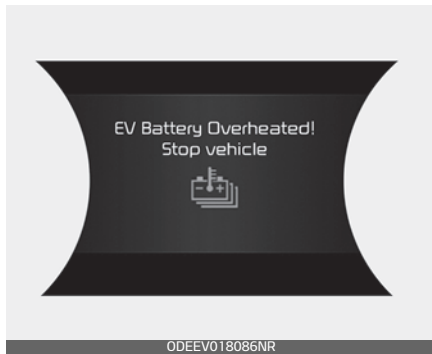

This warning message is displayed to protect battery and electric vehicle system when the high voltage battery temperature is too high.

Turn off the POWER button and stop the vehicle so that the battery temperature decreases.

⚠ WARNING

If this warning is still displayed even after the POWER button has been turned off for sufficient time, refrain from driving and have the vehicle inspected by an authorized Kia dealer.

Stop vehicle and check power supply



This warning message is displayed when a failure occurs in the 12 V power supply system.

If this occurs, park the vehicle in a safe location and we recommend that you tow your vehicle to the nearest authorized Kia dealer and have the vehicle inspected.

Unplug vehicle to start



This message is displayed when you start the vehicle, without unplugging the charging cable, and will not shift out of park. Unplug the charging cable, and then turn on the vehicle.

Charging Door Open



This message is displayed when the vehicle is driven with the charging door opened. Close the charging door and then start driving.

Remaining Time



* The remaining charging time in the LCD image may differ from actual charging time.

This message is displayed to notify the remaining time to charge the battery, to the selected target battery charge level, and the charge voltage level.

Charging Stopped Check the AC/DC charger

AC Charge



Trickle Charge



This warning message is displayed when charging is stopped for the reasons below:

- There is a problem with the external AC charger or DC charger.
- The external AC charger stopped charging
- The charging cable is damaged.

If this occurs, check whether there is any problem with the external normal or DC charger and charging cable.

If the same problem occurs when charging the vehicle with a well-functioning AC charger or genuine Kia portable charger, have your vehicle inspected by an authorized Kia dealer.

Charging Stopped. Check the Cable Connection

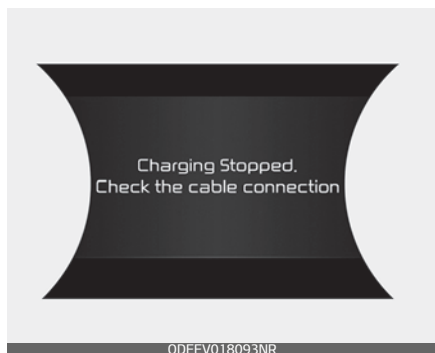

This warning message is displayed for the reasons below:

- The charging connector is not correctly connected to the charging inlet.
- The charging connector lock release button is pressed.

If this occurs, separate the charging connector and re-connect it.

Check whether there is any problem (external damage, foreign substances, etc.) with the charging connector and charging inlet.

If the same problem occurs when charging the vehicle with a replaced charging cable or genuine Kia port-

able charger, we recommend that you have your vehicle inspected by an authorized Kia dealer.

12 V Aux. Battery Saver+

The Aux. Battery Saver+ is a function that monitors the charging status of the 12 V auxiliary battery.

If the auxiliary battery level is low, the main high voltage battery charges the auxiliary battery.

The Aux. Battery Saver+ function will be ON when the vehicle is delivered. If the function is not needed, you may turn it off in the Users Settings mode on the cluster.

Mode

Cycle Mode

When the POWER button is in the OFF position with all doors, hood and liftgate closed, the Aux. Battery Saver+ activates.

Automatic Mode

When the POWER button is in the ON position with the charging connector plugged in, the function activates to prevent overdischarge of the auxiliary battery.

* The Aux. Battery Saver+ activates maximum of 20 minutes. If the Aux. Battery Saver+ function activates more than 10 times consecutively when in the automatic mode, the function will stop activating, judging that there is a

problem with the auxiliary battery. In this case, drive the vehicle for some period of time or if the auxiliary battery returns to normal, the function will start activating.

* NOTICE

The Aux. Battery Saver+ function cannot prevent battery discharge if the auxiliary battery is damaged, worn out, used as a power supply or unauthorized electronic devices are used.

If the Aux. Battery Saver+ function was activated, a message will be displayed on the instrument cluster and the high voltage battery level may have decreased.

System Setting

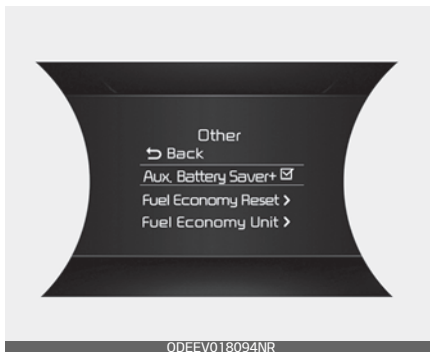

The driver can activate the Aux. Battery Saver+ function by placing the POWER button to the ON position and by selecting:

'User Settings → Other → Aux. Battery Saver+'

The Aux. Battery Saver+ function deactivates, when the driver cancels the system setting.

LCD Message

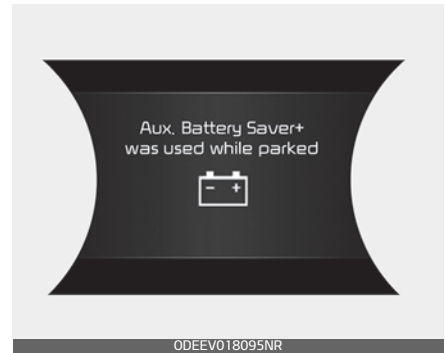

This message is displayed when the Aux. Battery Saver+ function deactivates.

⚠ WARNING

When the function is activated, the indicator lamp will illuminate and 360 V high voltage electricity will be flowing in the vehicle.

Do not touch, separate or disassemble all the electric and electronic components and devices including the high voltage electric wire, connector. This may cause electric shock and lead to fatal injuries.

Also, do not modify your vehicle in any way. This may affect your vehicle performance and lead to an accident.

Utility Mode (if equipped)

When driving is not necessary such as while camping or when stopping the vehicle for a long time, it is possible to use the electrical devices (audio, lights, etc.) for long hours.

The high voltage battery is used instead, to maintain the 12 V auxiliary battery, for operating the convenient 12 V features of the vehicle.

System Setting and Conditions

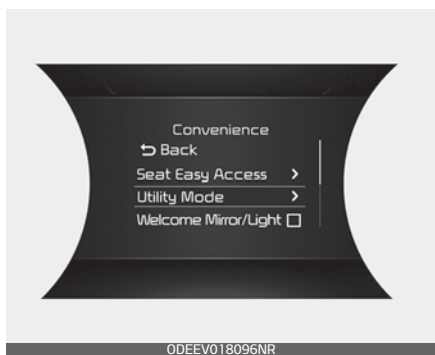

When the following conditions are satisfied, you can activate the Utility Mode function by selecting 'User Settings → Utility Mode' in the cluster.

- The vehicle is in the ready  mode.
- The gear is shifted to P (Park).
- The EPB (Electronic Parking Brake) is applied.

System Activation

When the system is activated:

- The  indicator will turn off and the **UTIL** indicator will illuminate on the cluster.
- All electric devices are usable but the vehicle cannot be driven.
- The EPB can be cancelled by pressing the EBP switch.
- Gear cannot be shifted out of P (Park). If a shift attempt is made, a message "Shifting conditions not met" will be displayed on the cluster.

Deactivation

The Utility Mode can be deactivated by pressing the POWER button to the OFF position

Warning and Indicator Lights (related to electric vehicle)

The warning light and indicator light indicate the situation where the driver should be careful and whether the various functions are activated.

Ready Indicator

This indicator illuminates:

When the vehicle is ready to be driven.

- ON: Normal driving is possible.
- OFF: Normal driving is not possible, or a problem has occurred.
- Blinking: Emergency driving.

When the ready indicator goes OFF or blinks, there is a problem with the system. In this case, have your vehi-

cle inspected by an authorized Kia dealer.

Service Warning Light

This warning light illuminates:

- When the POWER button is in the ON position.
 - It illuminates for approximately 3 seconds and then goes off.
- When there is a problem with related parts of the electric vehicle control system, such as sensors, etc.

When the warning light illuminates while driving, or does not go OFF after starting the vehicle, have your vehicle inspected by an authorized Kia dealer.

Regenerative Brake Warning Light

 (red color)  (yellow color)

This warning light illuminates:

When the regenerative brake does not operate and the brake does not perform well. This causes the Brake Warning light (red) and Regenerative Brake Warning Light (yellow) to illuminate simultaneously.

In this case, drive safely and have the vehicle inspected by an authorized Kia dealer.

The operation of the brake pedal may be more difficult than normal, and the braking distance can increase, as it may default to manual hydraulic mode.

High Voltage Battery Low Level Warning Light

This warning light illuminates:

When the high voltage battery level is low.

When the warning light turns ON, charge the battery immediately.

Power Down Warning

This warning light illuminates:

For safety when power is limited. The power is limited for the following reasons.

- The high voltage battery level is below a certain level or voltage is decreasing
- The temperature of the motor or high voltage battery is too high or too low
- There is a problem with the cooling system, or a failure that may interrupt normal driving

*** NOTICE**

Do not accelerate or start the vehicle suddenly when the power down warning light is ON.

Charge the battery immediately when the high voltage battery level is not enough.

Charging Cable Connection Indicator



This indicator illuminates in red when the charging cable is connected.

Safety Precautions for Electric Vehicle

Be sure to read the information in this section to help you drive safely.

If an Accident Occurs

⚠️ WARNING

- When a vehicle accident occurs, move the vehicle to a safe place, turn OFF the vehicle and remove the auxiliary battery (12 V) terminal to prevent high voltage electricity from flowing.
- If electric wires are exposed from inside or outside the vehicle, do not touch the wires. Also, do not touch the high voltage electric wire (orange), connector, and all electric components and devices. This may cause electric shock and lead to injuries.

⚠️ WARNING

When a vehicle accident occurs and the high voltage battery is damaged, harmful gas and electrolytes may leak. Be careful not to touch the leaked liquid.

When you suspect leakage of inflammable gas and other harmful gases, open the windows and evacuate to a safe place. If any leaked fluid comes in contact with your eyes or skin, immediately clean the affected area thoroughly with tap water or saline solution and have doctors inspect it as soon as possible.

⚠️ WARNING

If a small scale fire occurs, use a fire extinguisher (ABC, BC) that is meant for electrical fires. If it is impossible to extinguish the fire in the early stage, maintain a safe distance away from the vehicle and immediately call your local fire emergency responders.

Also, advise them that an electric vehicle is involved.

If the fire spreads to the high voltage battery, large amount of water is needed to put out the fire. Using small amount of water or fire extinguishers not meant for electrical fires could cause serious injury or death from electrical shocks.

⚠️ WARNING

If you cannot put out the fire immediately, the high voltage battery may explode. Evacuate to a safe place and do not let other people approach the site.

Contact the fire department and notify them of an electric vehicle fire.

If the vehicle is flooded with water, immediately turn OFF the vehicle and evacuate to a safe place. Contact the fire department or an authorized Kia dealer.

If towing is required, lift all four wheels off the ground and tow the vehicle.

Flatbed Towing / Flatbed Towing / Tires Locked Towing

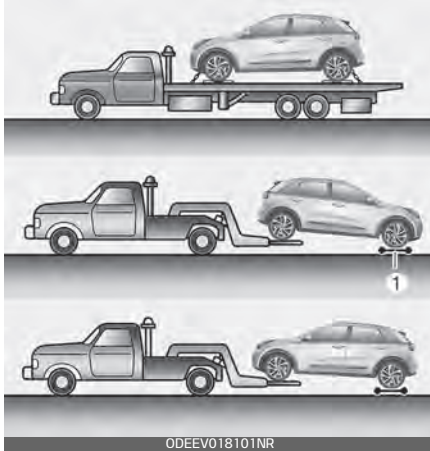

If you must tow the vehicle using only two wheels, lift the front wheels off the ground and tow the vehicle.

If necessary to roll the vehicle so that it can be rolled onto a flatbed tow truck perform the following:

- First, depress the brake pedal and release the parking brake.
- While depressing the brake pedal shift to the N (Neutral) position and press the POWER button to turn the vehicle off.
- Wait 3 minutes or more before opening the driver door and the vehicle will remain in ACC mode and in Neutral.

- If the driver door is opened within the 3 minute period, the vehicle will automatically shift to P (Park), the vehicle will turn OFF and the front wheels will be remained locked.

⚠ WARNING

- If you tow the vehicle while the front wheels are touching the ground, the vehicle motor may generate electricity and the motor components may be damaged or a fire may occur.



ODEEV018102NR

- When a vehicle fire occurs due to the battery, there is a risk of a second fire. Contact your local fire emergency responders when towing the vehicle.

Other Precautions for Electric Vehicle

- When you paint, apply heat treatment to the vehicle as a result of an accident, and/or weld on the vehicle, the performance of the high voltage battery can be reduced.

If heat treatment is required, have the vehicle serviced by an authorized Kia dealer and have the HV battery removed, prior to any repairs.

⚠ WARNING

When you clean the motor compartment, do not use high pressure water to wash. This may cause an electric shock due to a discharge in high voltage electricity, or damage the vehicle's electric system.

⚠ CAUTION

Do not use, remodel, or install non-genuine parts. This may damage the electric power system.

Service Interlock Connector

In case of emergency, cut the service interlock connector cable to isolate the high voltage of the battery.



ODEEV018103NR

Service Plug

The service plug is under the rear seat. It is for professional service and maintenance.



ODEEV018104NR

⚠ CAUTION

Never touch the service plug under the rear seat.

The service plug is attached to the high voltage battery system.

Touching the service plug will result in death or serious injury. Service personnel should follow procedures in service manual.

Vehicle data collection and event data recorders 2-2

INTRODUCTION

Vehicle data collection and event data recorders

This vehicle is equipped with an event data recorder (EDR). The main purpose of an EDR is to record, in certain crash or near crash-like situations, such as an air bag deployment or hitting a road obstacle, data that will assist in understanding how a vehicle's systems performed. The EDR is designed to record data related to vehicle dynamics and safety systems for a short period of time, typically 30 seconds or less. The EDR in this vehicle is designed to record such data as:

- How various systems in your vehicle were operating;
- Whether or not the driver and passenger safety belts were buckled/ fastened;
- How far (if at all) the driver was depressing the accelerator and/or brake pedal; and,
- How fast the vehicle was traveling.

These data can help provide a better understanding of the circumstances in which crashes and injuries occur.

EDR data are recorded by your vehicle only if a non-trivial crash situation occurs; no data are recorded by the EDR under normal driving conditions and no personal data (e.g., name, gender, age, and crash location) are recorded. However, other parties, such as law enforcement, could combine the EDR data with the type of personally identifying data routinely acquired during a crash investigation.

To read data recorded by an EDR, special equipment is required, and access to the vehicle or the EDR is needed. In addition to the vehicle manufacturer, other parties, such as law enforcement, that have the special equipment, can read the information if they have access to the vehicle or the EDR.

Your vehicle at a glance **3**

Exterior overview.....	3-2
Interior overview.....	3-5
Instrument panel overview	3-7
Motor room compartment.....	3-9

YOUR VEHICLE AT A GLANCE

Exterior overview

Front view



ODEEV048001NR

* The actual shape may differ from the illustration.

1. Hood	5-24
2. Head lamp (Features of your vehicle)	5-92
Head lamp (Maintenance)	8-58
3. Day time running light (D.R.L)	5-91
4. Fog lamp	5-94
5. Wheel and tire	8-25
6. Outside rearview mirror	5-42
7. Sunroof	5-26

8. Front windshield wiper blades (Features of your vehicle)	5-98
Front windshield wiper blades (Maintenance)	8-20
9. Windows	5-20
10. Parking Distance Warning	5-85
11. Roof rack	5-135
12. Charging door	5-45

Rear view



ODEEV048002NR

* The actual shape may differ from the illustration.

1. Door locks	5-13
2. Rear combination lamp (Maintenance)	8-56
3. High mounted stop lamp (Maintenance)	8-62
4. Back up lamp	8-62
5. Liftgate	5-18
6. Antenna	5-136
7. Rear wiper and rearview camera	5-100, 5-90
8. Parking Distance Warning	5-81, 5-85

Interior overview

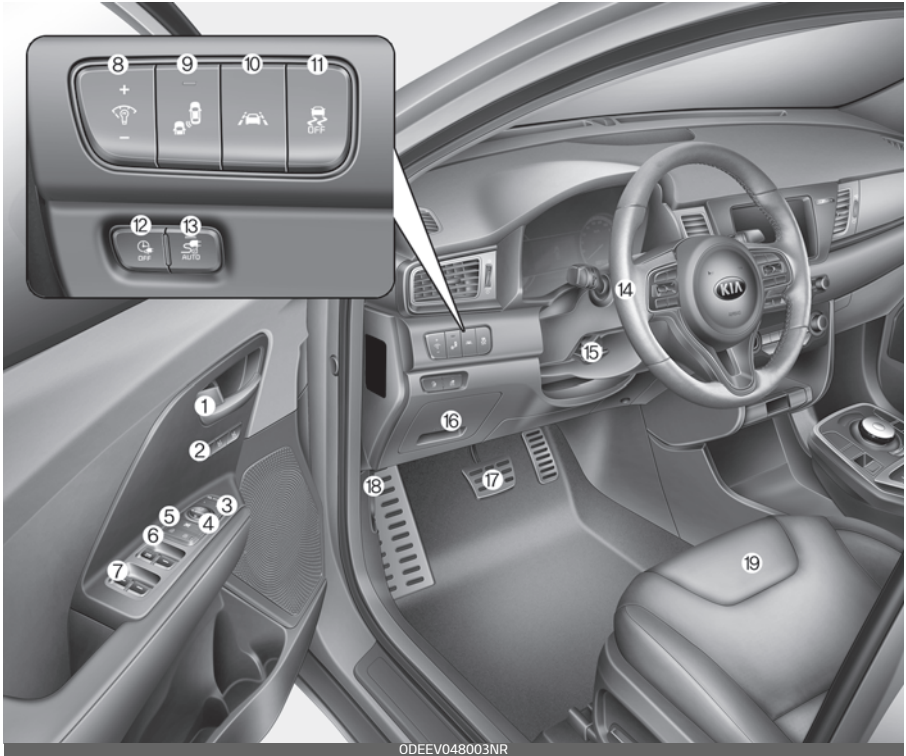

* The actual shape may differ from the illustration.

- | | |
|--|-------|
| 1. Inside door handle | 5-15 |
| 2. Front seat position memory button | 4-10 |
| 3. Outside rearview mirror folding | 5-43 |
| 4. Outside rearview mirror control | 5-43 |
| 5. Power window lock button | 5-23 |
| 6. Central door lock switch | 5-15 |
| 7. Power window switch | 5-20 |
| 8. Instrument panel illumination control | 5-47 |
| 9. BCW On/Off button | 6-79 |
| 10. LKA On/Off button | 6-108 |
| 11. ESC Off button | 6-39 |
| 12. Scheduled charging deactivation button | 1-18 |
| 13. Auto Lock mode button | 1-17 |

14. Steering wheel	5-31
15. Tilt and telescopic steering control lever	5-32
16. Inner fuse panel	8-41
17. Brake pedal	6-27
18. Hood release lever	5-24
19. Seat	4-5

Instrument panel overview

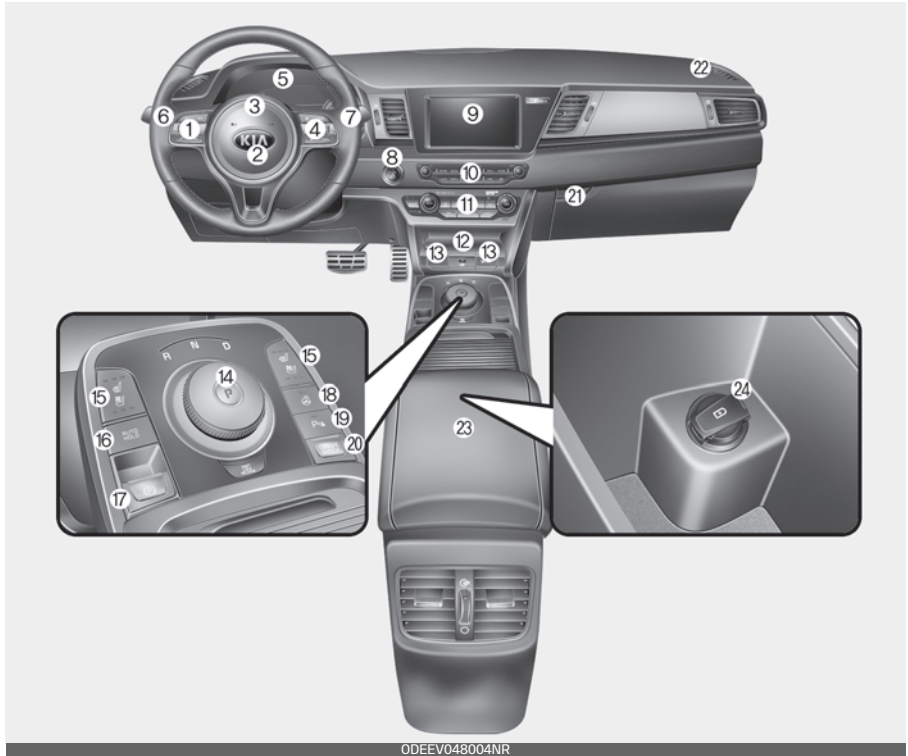

ODEEV048004NR

* The actual shape may differ from the illustration.

- | | |
|---|-------|
| 1. Steering wheel audio controls
(Refer to the "CAR MULTIMEDIA SYSTEM USER'S MANUAL".) | |
| 2. Driver's front air bag | 4-55 |
| 3. Horn | 5-34 |
| 4. Cruise control | 6-59 |
| 5. Instrument cluster | 5-46 |
| 6. Lighting control lever | 5-92 |
| Turn signal / headlamp control lever (Left) | 5-94 |
| 7. Wiper and washer control lever (Right) | 5-98 |
| 8. Power button | 6-6 |
| 9. Multimedia system | 5-136 |
| 10. Hazard warning flasher | 7-3 |
| 11. Climate control system | 5-106 |

12.Wireless cellular phone charging system	5-128
13.Power outlet	5-127
14.Reduction gear (shift button)	6-10
15.Seat warmer / Air ventilation seat	5-124, 5-125
16.Auto Hold switch	6-33
17.EPB (Electronic Parking Brake) switch	6-28
18.Heated steering wheel button	5-33
19.Parking Distance Warning (Reverse/Forward) ON button / Parking Distance Warning (Reverse) OFF button	5-86
20.Drive mode button	6-76
21.Glove box	5-121
22.Passenger's front air bag	4-55
23.Center console storage box	5-121
24.USB charger	5-128

Motor room compartment

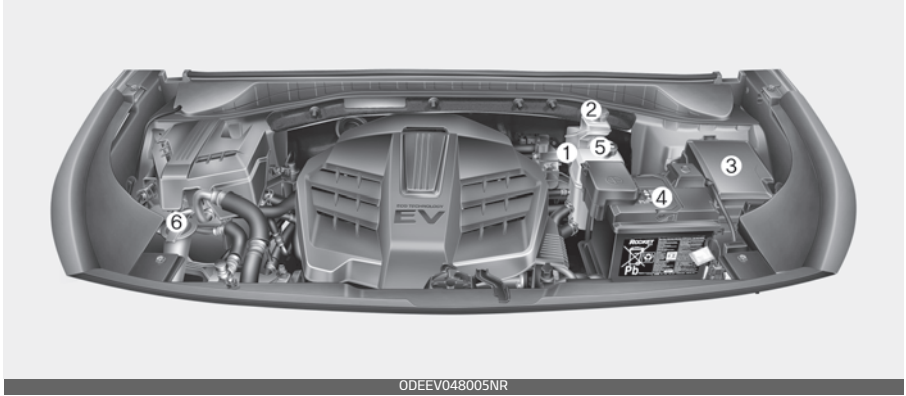

ODEEV048005NR

* The actual motor room in the vehicle may differ from the illustration.

- | | |
|--------------------------------------|------|
| 1. Coolant reservoir | 8-14 |
| 2. Brake fluid reservoir | 8-17 |
| 3. Fuse box | 8-42 |
| 4. Battery (12 volt) | 8-23 |
| 5. Coolant reservoir cap | 8-15 |
| 6. Windshield washer fluid reservoir | 8-18 |

Important safety precautions	4-3
Seat	4-5
• Feature of Seat Leather	4-8
• Front seat adjustment for manual seat	4-8
• Front seat adjustment for power seat	4-9
• Driver position memory system for power seat	4-10
• Headrest for front seat.....	4-12
• Seatback pocket	4-14
• Headrest for rear seat	4-15
• Armrest.....	4-16
• Folding the rear seat.....	4-16
Seat belts	4-19
• Seat belt restraint system	4-19
• Driver's seat belt warning.....	4-21
• Front passenger's seat belt warning	4-21
• Seat belt - Driver's 3-point system with emergency locking retractor	4-22
• Seat belts - Front passenger and rear seat 3-point system with combination locking retractor	4-24
• Stowing the rear seat belt.....	4-26
• Pre-tensioner seat belt.....	4-27
• Seat belt precautions.....	4-29
• Care of seat belts	4-31
Child Restraint System (CRS)	4-32
• Children always in the rear	4-32
• Selecting a Child Restraint System (CRS)	4-33
• Installing a Child Restraint System (CRS).....	4-35

4 Safety features of your vehicle

Air bag – advanced supplemental restraint system.....4-42

- How does the air bag system operate?4-43
- Do not install a child restraint on the front passenger's seat4-44
- Air bag warning light.....4-45
- Supplemental Restraint System (SRS) components and functions4-46
- Occupant Detection System (ODS).....4-48
- Driver's and passenger's front air bag.....4-55
- Side air bag4-58
- Curtain air bag.....4-59
- Air bag collision sensors4-61
- Why didn't my air bag go off in a collision? (Inflation and non-inflation conditions of the air bag).....4-62
- Supplemental Restraint System (SRS) Care4-64
- Adding equipment to or modifying your air bag-equipped vehicle.....4-64
- Air bag warning label4-65

SAFETY FEATURES OF YOUR VEHICLE

Important safety precautions

You will find many safety precautions and recommendations throughout this section, and throughout this manual.

The safety precautions in this section are among the most important.

Always wear your seat belt

A seat belt is your best protection in all types of accidents. Air bags are designed to supplement seat belts, not replace them. So even though your vehicle is equipped with air bags, ALWAYS make sure you and your passengers wear your seat belts, and wear them properly.

Restrain all children

All children under age 13 should ride in your vehicle properly restrained in a rear seat, not the front seat. Infants and small children should be restrained in an appropriate child restraint. Larger children should use a booster seat with the lap/shoulder belt until they can use the seat belt properly without a booster seat.

Air bag hazards

While air bags can save lives, they can also cause serious or fatal injuries to occupants who sit too close to them, or who are not properly restrained. Infants, young children, and shorter adults are at the greatest risk of being injured by an inflating air bag. Follow all instructions and warnings in this manual.

Driver distraction

Driver distraction presents a serious and potentially deadly danger, especially for inexperienced drivers. Safety should be the first concern when behind the wheel and drivers need to be aware of the wide array of potential distractions, such as drowsiness, reaching for objects, eating, personal grooming, other passengers, and using cellular phones.

Drivers can become distracted when they take their eyes and attention off the road or their hands off the wheel to focus on activities other than driving. To reduce your risk of distraction or getting into an accident:

- ALWAYS set up your mobile devices (i.e., MP3 players, phones, navigation units, etc.) when your vehicle is parked or safely stopped.

- ONLY use your mobile device when allowed by laws and when conditions permit safe use. NEVER text or email while driving. Most states have laws prohibiting drivers from texting. Some states and cities also prohibit drivers from using handheld phones.
- NEVER let the use of a mobile device distract you from driving. You have a responsibility to your passengers and others on the road to always drive safely, with your hands on the wheel as well as your eyes and attention on the road.

Control your speed

Excessive speed is a major factor in crash injuries and deaths. Generally, the higher the speed, the greater the risk, but serious injuries can also occur at lower speeds. Never drive faster than is safe for current conditions, regardless of the maximum speed posted.

Keep your vehicle in safe condition

Having a tire blowout or a mechanical failure can be extremely hazardous. To reduce the possibility of such problems, check your tire pressures and condition frequently, and perform all regularly scheduled maintenance.

Seat

The following explains name, feature and adjustment of each seat.



4

ODEEV058001NR

Front seat

1. Forward and backward
2. Seatback angle
3. Seat cushion height (Driver's seat)
4. Lumbar support (Driver's seat) (if equipped)
5. Head rest

Rear seat

6. Seatback folding
 7. Headrest
 8. Armrest (if equipped)
- *: if equipped

⚠ WARNING**Loose objects**

Do not place anything in the driver's footwell or under the front seats. Loose objects in the driver's foot area could interfere with the operation of the foot pedals.

⚠ WARNING**Uprighting seat**

Do not press the release lever on a manual seatback without holding and controlling the seatback. The seatback will spring upright possibly impacting you or other passengers.

⚠ WARNING**Driver responsibility for passengers**

0DEEV058002NR

The driver must advise the passengers to keep the seatback in an upright position whenever the vehicle is in motion. If a seat is reclined during an accident, the restraint system's ability to restrain will be greatly reduced.

⚠ WARNING**Seat cushion**

Occupants should never sit on after-market seat cushions or sitting cushions. The passenger ODS system may not operate properly, or passenger's hips may slide under the lap portion of the seat belt during an accident or a sudden stop.

⚠ WARNING**Driver's seat**

- Never attempt to adjust the seat while the vehicle is moving. This could result in loss of control of your vehicle.
- Do not allow anything to interfere with the normal position of the seatback. Storing items against the seatback could result in serious or fatal injury in a sudden stop or collision.
- Sit as far back as possible from the steering wheel while still maintaining comfortable control of the your vehicle. A distance of at least 10 in (25 cm) from your chest to the steering wheel is recommended. Failure to do so can result in air bag inflation injuries to the driver.

⚠ WARNING**Rear seatbacks**

Always lock the rear seatback before driving. Failure to do so could result in passengers or objects being thrown forward injuring vehicle occupants.

⚠ WARNING**Unexpected Seat Movement**

After adjusting a manual seat, always check that it is locked by shifting your weight to the front and back. Sudden or unexpected movement of the driver's seat could cause you to lose control of the vehicle.

⚠ WARNING**Seat adjustment**

- Do not adjust the seat while wearing seat belts. Moving the seat forward will cause strong pressure on the abdomen.
 - Do not place your hand near the seat bottom or seat track while adjusting the seat. Your hand could get caught in the seat mechanism.
-

⚠ WARNING**Luggage and Cargo**

Do not stack pile or stack luggage or cargo higher than the seatback in the cargo area. In an accident the cargo could strike and injure a passenger. If objects are large, heavy or must be piled, they must be secured in the cargo area.

⚠ WARNING**Cargo Area**

Do not allow passengers to ride in the cargo area under any circumstance. The cargo area is solely for the purpose of transporting luggage or cargo.

⚠ WARNING**Small Objects**

Use extreme caution when picking up small objects trapped under the seats or between the seat and the center console. Your hands might be cut or injured by the sharp edges of the seats mechanism.

Feature of Seat Leather

Leather is made from the outer skin of an animal, which goes through a special process to be available for use. Since it is a natural substance, each part differs in thickness or density.

- Wrinkles may appear as a natural result of stretching and shrinking depending on the temperature and humidity.
- The seat is made of stretchable fabric to improve comfort.
- The parts contacting the body are curved and the side supporting area is high which provides driving comfort and stability.

⚠ CAUTION

- Belts with metallic accessories, zippers or keys inside the back pocket may damage the seat fabric.
- Make sure not to wet the seat. It may change the nature of natural leather.
- Jeans or clothes which could bleach may contaminate the surface of the seat covering fabric.

* NOTICE

Wrinkles or abrasions may appear naturally from usage. It is not a fault of product. Wrinkles or abrasions are not covered by warranty.

Front seat adjustment for manual seat

The front seat can be adjusted by using the control levers located on the outside of the seat cushion.



0DEEV058003NR

Forward and backward (1)

Adjust the seat before driving, and make sure the seat is locked securely by trying to move forward and backward without using the lever. If the seat moves, it is not locked properly.

To move the seat forward or backward:

1. Pull the seat slide adjustment lever up and hold it.
2. Slide the seat to the position you desire.
3. Release the lever and make sure the seat is locked in place.

Seatback angle (2)

To recline the seatback:

1. Lean forward slightly and lift up the seatback recline lever.
2. Carefully lean back on the seat and adjust the seatback of the seat to the position you desire.
3. Release the lever and make sure the seatback is locked in place. (The lever **MUST** return to its original position for the seatback to lock.)

⚠ WARNING

Reclining seatback

Sitting in a reclined position when the vehicle is in motion can be dangerous. Even when buckled up, the protections of your restraint system (seat belts and/or air bags) is greatly reduced by reclining your seatback.

Seat belts must be snug against your hips and chest to work properly. When the seatback is reclined, the shoulder belt cannot do its job because it will not be snug against your chest. Instead, it will be in front of you. During an accident, you could be thrown into the seat belt, causing neck or other injuries.

The more the seatback is reclined, the greater chance the passenger's hips will slide under the lap belt or the passenger's neck will strike the shoulder belt.

Seat height (3)

To change the height of the seat, push the lever upwards or downwards.

- To lower the seat cushion, push the lever down several times.
- To raise the seat cushion, pull the lever up several times.

Front seat adjustment for power seat (if equipped)

The front seat can be adjusted by using the control switches located on the outside of the seat cushion.



Before driving, adjust the seat to the proper position so you can easily control the steering wheel, pedals and switches on the instrument panel.

Forward and backward (1)

To move the seat forward or backward:

- Push the control switch forward or backward to move the seat to the desired position. Release the switch once the seat reaches the desired position.

Seatback angle (2)

To recline the seatback:

- Push the control switch forward or backward to move the seatback to the desired angle. Release the switch once the seat reaches the desired position.

Seat height (3)

To change the height of the seat:

- Pull the front portion of the control switch up to raise or press down to lower the front part of the seat cushion. Pull the rear portion of the control switch up to raise or press down to lower the seat cushion. Release the switch once the seat reaches the desired position.

Lumbar support for driver's seat (4) (if equipped)

The lumbar support can be adjusted by pressing the lumbar support switch on the side of the seat.

1. Press the front portion of the switch to increase support, or the rear portion of the switch, to decrease support.
2. Release the switch once it reaches the desired position.

Driver position memory system for power seat (if equipped)

A driver position memory system is provided to store and recall the driver seat and outside rearview mirror position with a simple button operation.



0DEEV058005NR

By saving the desired position into the system memory, different drivers can reposition the driver seat based upon their driving preference. If the battery is disconnected, the desired seat position memory will need to be re-saved.

⚠ WARNING**Driver Position Memory System**

Never attempt to operate the driver position memory system while the vehicle is moving.

This could result in loss of control, and an accident causing death or serious injury.

Storing driver's seat positions

1. Turn the shifter dial into P while the POWER button is ON.
2. Adjust the driver's seat and outside rearview mirror comfortable for the driver.
3. Press SET button on the control panel. The system will beep once.
4. Press one of the memory buttons (1 or 2) within 4 seconds after pressing the SET button. The system will beep twice when memory has been successfully stored.

When recalling an adjustment memory button while sitting in the vehicle, you can be surprised by the setting chosen if the memory has been adjusted by someone else. If that occurs, immediately push the seat position control switch in the direction of the desired position to stop further undesired movement.

Recalling positions from memory

1. Shift the shift lever into P.
2. To recall the position in the memory, press the desired memory button (1 or 2). The system will beep once, then the driver's seat will automatically adjust to the stored position.

Adjusting the control switch for the driver's seat while the system is recalling the stored position will cause the movement to stop and move in the direction that the control switch is moved.

Easy access function (if equipped)

The system will move the driver's seat automatically as follows:

- With smart key system
 - It will move the driver's seat rearward when POWER button is changed to the OFF position.
 - It will move the driver's seat forward when the POWER button is changed to the ACC or ON position.
 - It will move the driver's seat forward when you get in your vehicle with the smart key after closing the driver's door.

You can activate or deactivate this feature. Refer to "User settings mode" on page 5-56.

Headrest for front seat

The driver's and front passenger's seats are equipped with a headrest for the occupant's safety and comfort.



ODEEV058006NR

The headrest not only provides comfort for the driver and front passenger, but also helps protect the head and neck in the event of a rear collision.

For maximum effectiveness in case of an accident, the headrest should be adjusted so the middle of the headrest is at the same height of the center of gravity of an occupant's head. Generally, the center of gravity of most people's head is similar with the height of the top of their eyes.

Also, adjust the headrest as close to your head as possible. For this reason, the use of a cushion that holds the body away from the seatback is not recommended.

⚠ WARNING

Headrest removal/adjustment

- Do not operate the vehicle with the headrests removed. Headrests can provide critical neck and head support in a crash.
- Do not adjust the headrest height while the vehicle is in motion. Driver may lose control of the vehicle.

⚠ CAUTION

Excessive pulling or pushing may damage the headrest.

Adjusting the height up and down

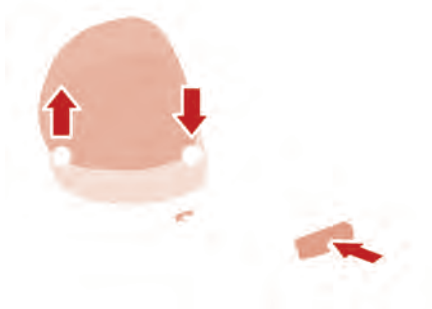

ODEEV058007NR

To raise the headrest:

1. Pull it up to the desired position (1).
2. To lower the headrest, push and hold the release button (2) on the headrest support.
3. Lower the headrest to the desired position (3).

*** NOTICE**

If you recline the seatback towards the front with the headrest and seat cushion raised, the headrest may come in contact with the sun visor or other parts of the vehicle.



ODEEV058008NR

Removal

Type A



ODEEV058009NR

Type B



ODEEV058010NR

To remove the headrest:

1. Recline the seatback (2) with the recline lever or switch (1).
2. Raise headrest as far as it can go.
3. Press the headrest release button (3) while pulling the headrest up (4).

4

⚠ WARNING

Headrest Removal

NEVER allow anyone to ride in a seat with the headrest removed or reversed. Headrests can provide critical neck and head support in a crash.

Reinstallation

Type A



ODEEV058011NR

Type B



ODEEV058012NR

To reinstall the headrest:

1. Put the headrest poles (2) into the holes while pressing the release button (1).
2. Recline the seatback (4) with the recline lever or switch (3).
3. Adjust the headrest to the appropriate height.

⚠ WARNING

Headrest Reinstallation

To reduce the risk of injury to the head or neck, always make sure the headrest is locked into position and adjusted properly after reinstalling.

Seatback pocket

The seatback pocket is provided on the back of the front passenger's and driver's seatbacks.



ODEEV058013NR

⚠ WARNING

Seatback pockets

Do not put heavy or sharp objects in the seatback pockets. In an accident they could come loose from the pocket and injure vehicle occupants.

Headrest for rear seat

The rear seat is equipped with headrests in all the seating positions for the occupant's safety and comfort.



ODEEV058014NR

The headrest not only provides comfort for passengers, but also helps protect the head and neck in the event of a collision.

For maximum effectiveness in case of an accident, the headrest should be adjusted so the middle of the headrest is at the same height of the center of gravity of an occupant's head. Generally, the center of gravity of most people's heads is similar with the height as the top of their eyes.

Also, adjust the headrest as close to your head as possible. For this reason, the use of a cushion that holds the body away from the seatback is not recommended.

Adjusting the height up and down



ODEEV058016NR

- To raise the headrest, pull it up to the desired position (1).
- To lower the headrest, push and hold the release button (2) on the headrest support and lower the headrest to the desired position (3).

4

Removal and reinstallation



ODEEV058015NR

- To remove the headrest, raise it as far as it can go then press the release button (1) while pulling the headrest upward (2).

- To reinstall the headrest, put the headrest poles (3) into the holes while pressing the release button (1).
- Then adjust it to the appropriate height and ensure that it locks in position.

Armrest (if equipped)

To use the armrest, pull it forward from the seatback.



ODEEV058017NR

Folding the rear seat

The rear seatbacks may be folded to facilitate carrying long items or to increase the luggage capacity of the vehicle.

⚠ WARNING

Folded Seatback

The purpose of the fold-down rear seatbacks is to allow you to carry longer objects that could not otherwise be accommodated.

- Never allow a passenger to sit on top of the folded down seatback

while the car is moving. This is not a proper seating position since no seat belts are available for use.

- To reduce the risk of injury caused by sliding cargo within the passenger compartment of the vehicle, objects carried on the folded down seatback should not extend higher than the top of the front seats.

To fold down the rear seatback

1. Set the front seatback to the upright position and if necessary, slide the front seat forward.



ODEEV058018NR

2. Lower the rear headrests to the lowest position as above the picture.

⚠ WARNING

Objects

Objects carried on the folded down seatback should not extend higher than the top of the front seatbacks. This could allow cargo to slide forward and cause injury or damage during sudden stops.

- When folding the seatback, insert the rear seat belt buckle in the pocket between the rear seatback and cushion then make sure both seatbelts do not interfere with stowed luggage and cargo. Then, insert the seat belt into the two holes located on both sides.



ODEEV058021NR

- To use the rear seat, lift and pull the seatback backward by lifting up seatback. Pull the seatback firmly until it clicks into place. Make sure the seatback is locked in place.

4



ODEEV058019NR



ODEEV058020NR

- Pull on the seatback folding lever, then fold the seat toward the front of the vehicle. When you return the seatback to its upright position, always be sure it has locked into position by pushing on the top of the seatback.



ODEEV058022NR

- Return the rear seat belt to the proper position.

⚠ WARNING**Uprighting seat**

When you return the seatback to its upright position, hold the seatback and return it slowly. If the seatback is returned without holding it, the back of the seat could spring forward, resulting in injury caused by being struck by the seatback.

⚠ WARNING**Rear Seatback**

To ensure maximum protection in the event of an accident or sudden stop, when returning the rear seat to the upright position:

- Be careful not to damage the seat belt webbing or buckle.
- Do not allow the seat belt webbing or buckle to become pinched or caught in the rear seat.
- Ensure the seatback is completely locked into its upright position by pushing on the top of the seatback.

Failure to adhere to any of these instructions could result in serious injury or death in the event of a crash.

⚠ CAUTION**Damaging rear seat belt buckles**

When you fold the rear seatback, insert the buckle between the rear seatback and cushion. Doing so can prevent the buckle from being damaged by the rear seatback.

⚠ CAUTION**Rear seat belts**

When returning the rear seatbacks to the upright position, remember to return the rear shoulder belts to their proper position.

⚠ WARNING

Unless the driver's position is properly set according to the driver's physical figure, do not fold the rear seat. It may increase bodily injuries in a sudden stop or collision.

⚠ CAUTION

Be careful when loading cargo through the rear passenger seats to prevent damage to the vehicle interior.

⚠ WARNING**Cargo**

Cargo should always be secured to prevent it from being thrown about the vehicle in a collision and causing injury to the vehicle occupants. Do not place objects in the rear seats, since they cannot be properly secured and may hit the front seat occupants in a collision.

Cargo loading

Make sure the vehicle is off, the shifter dial is in P (Park) and the parking brake is securely applied whenever loading or unloading cargo. Failure to take these steps may allow the vehicle to move if the shift lever is inadvertently moved to another position.

Seat belts

The following explains seat belts precautions and how to fasten seat belts.

Seat belt restraint system

For maximum restraint system protection, the seat belts must always be used whenever the vehicle is moving.

- A properly positioned shoulder belt should be positioned midway over your shoulder across your collarbone.
- Never allow children to ride in the front passenger seat. See "Child Restraint System (CRS)" on page 4-32 for further discussion.

⚠ WARNING**Twisted seat belt**

Make sure your seat belt is not twisted when worn. A twisted seat belt may not properly protect you in an accident and could even cut into your body.

⚠ WARNING**Shoulder Belt**

- Never wear the shoulder belt under your arm or behind your back. An improperly positioned shoulder belt cannot protect the occupant in a crash.
- Always wear both the shoulder portion and lap portion of the lap/shoulder belt.

⚠ WARNING**Damaged seat belt**

Replace the entire seat belt assembly if any part of the webbing or hardware is damaged as you can no longer be sure that a damaged seat belt will provide protection in a crash.

Seat belts are designed to bear upon the bony structure of the body, and should be worn low across the front of the pelvis, chest and shoulders, as applicable; wearing the lap section of the belt across the abdominal area must be avoided.

Seat belts should be adjusted as firmly as possible, consistent with comfort, to provide the protection for which they have been designed.

A slack belt will greatly reduce the protection afforded to the wearer.

Care should be taken to avoid contamination of the webbing with polishes, oils and chemicals, and particularly battery acid. Cleaning may safely be carried out using mild soap and water. The belt should be replaced if webbing becomes frayed, contaminated or damaged.

- No modifications or additions should be made by the user which would either prevent the seat belt adjusting devices from operating to remove slack, or prevent the seat belt assembly from being adjusted to remove slack.
- When you fasten the seat belt, be careful not to latch the seat belt in buckles of other seats. It is very dangerous and you may not be protected by the seat belt properly.
- Do not unfasten the seat belt and do not fasten and unfasten the seat belt repeatedly while driving. This could result in loss of control, and an accident causing death, serious injury, or property damage.
- When fastening the seat belt, make sure that the seat belt does not pass over objects that are hard or can break easily.

⚠ WARNING

Seat belt buckle

Do not allow foreign material (gum, crumbs, coins, liquids, etc.) to obstruct the seat belt buckle. This may prevent the seat belt from fastening securely.

Driver's seat belt warning

As a reminder to the driver, the seat belt warning light will illuminate for approximately 6 seconds each time the POWER button is in ON regardless of belt fastening.



ODEEV058023NR

If the driver continues not to fasten the seat belt, the warning light will stay illuminated and the warning chime will sound for approximately 6 seconds until the belt is fastened each time the POWER button is in ON. This will happen every time the POWER button is in ON.

If a driver continues not to fasten the seat belt and drives 6 mph (9 km/h) or more but less than 12 mph

(20 km/h), the warning light will stay illuminated. If a driver unfastens the seat belt while driving below 12 mph (20 km/h), the warning light will stay illuminated.

If a driver continues not to fasten the seat belt while driving over 12 mph (20 km/h), the seat belt warning chime will sound for approximately 100 seconds and the corresponding warning light will blink.

Front passenger's seat belt warning

As a reminder to the front passenger, the seat belt warning light will illuminate for approximately 6 seconds each time the POWER button is in ON regardless of belt fastening. If the front passenger continues not to fasten the seat belt, the warning light will stay illuminated until the belt is fastened each time POWER button is in ON.



ODEEV058024NR

If a front passenger continues not to fasten the seat belt and the vehicle is driven 6 mph (9 km/h) or more but less than 12 mph (20 km/h), the warning light will stay illuminated.

If a front passenger unfastens the seat belt while the vehicle is driven below 12 mph (20 km/h), the warning light will stay illuminated.

If a front passenger continues not to fasten the seat belt while the vehicle is driven over 12 mph (20 km/h), the seat belt warning chime will sound for approximately 100 seconds and the corresponding warning light will blink.

* NOTICE

- Even if the front passenger seat is not occupied, the seat belt warning light will illuminate for 6 seconds.
- The front passenger's seat belt warning may operate when luggage is placed on the front passenger seat.

Seat belt – Driver's 3-point system with emergency locking retractor

The following explains how to fasten and adjust the driver's seat belt.

To fasten your seat belt:



ODEEV058025NR

- Pull it out of the retractor and insert the metal tab (1) into the buckle (2). There will be an audible "click" when the tab locks into the buckle.



ODEEV058026NR

You should place the lap belt portion as low as possible and snugly across your hips. If the lap belt is located too high on your waist, it may increase the chance of injury in the event of a collision.

The arm closest to the seat belt buckle should be over the belt while the other arm should be under the belt as shown in the illustration. Never wear the seat belt under the arm closest to the door.

The seat belt automatically adjusts to the proper length only after the lap belt portion is adjusted manually so that it fits snugly around your hips. If you lean forward in a slow, easy motion, the belt will extend and let you move around. If there is a sudden stop or impact, however, the belt will lock into position. It will also lock if you try to lean forward too quickly.

* NOTICE

If you are not able to pull out the seat belt from the retractor, firmly pull the belt out and release it. Then you will be able to pull the belt out smoothly.

Height adjustment

You can adjust the height of the shoulder belt anchor to one of the 4 positions for maximum comfort and safety.



0DEEV058027NR

The height of the adjusting seat belt should not be too close to your neck. The shoulder portion should be adjusted so that it lies across your chest and midway over your shoulder near the door and not your neck.

To adjust the height of the seat belt anchor, lower or raise the height adjuster into an appropriate position.

- To raise the height adjuster, pull it up (1).
- To lower it, push it down (3) while pressing the height adjuster button (2).

Release the button to lock the anchor into position. Try sliding the height adjuster to make sure that it has locked into position.

Improperly positioned seat belts can cause serious injuries in an accident.

⚠ WARNING**Shoulder belt positioning**

Verify the shoulder belt anchor is locked into position at the appropriate height. Never position the shoulder belt across your neck or face. Improperly positioned seat belts can cause serious injuries in an accident.

⚠ WARNING**Seat belt replacement**

Replace your seat belts after being in an accident. Failure to replace seat belts after an accident could leave you with damaged seat belts that will not provide protection in the event of another collision.

Seat belts – Front passenger and rear seat 3-point system with combination locking retractor

The following explains how to fasten the passenger's and rear seat belt.

To fasten your seat belt:

Combination retractor type seat belts are installed in the rear seat positions to help accommodate the installation of child restraint systems. Although a combination retractor is also installed in the front passenger seat position, it is strongly recommended that children

always be seated in the rear seat. NEVER place any infant restraint system in the front seat of the vehicle.

This type of seat belt combines the features of both an emergency locking retractor seat belt and an automatic locking retractor seat belt.

- Pull it out of the retractor and insert the metal tab into the buckle. There will be an audible "click" when the tab locks into the buckle. When not securing a child restraint, the seat belt operates in the same way as the driver's seat belt (emergency locking retractor type).

It automatically adjusts to the proper length only after the lap belt portion of the seat belt is adjusted manually so that it fits snugly around your hips.

When the seat belt is fully extended from the retractor to allow the installation of a child restraint system, the seat belt operation changes to allow the belt to retract, but not to extend (automatic locking retractor type). Refer to "Securing a child restraint with a lap/shoulder belt" on page 4-39.

* NOTICE

Although the combination retractor provides the same level of protection for seated passengers in either emergency or automatic locking modes, have the seated passengers use the emergency locking feature for improved convenience. The automatic locking function is intended to facilitate child restraint installation. To convert from the automatic locking feature to the emergency locking operation mode, allow the unbuckled seat belt to fully retract.

⚠ CAUTION

Do NOT fold down the left portion of the rear seatback when the rear center seat belt is buckled. ALWAYS UNBUCKLE the rear center seat belt before folding down the left portion of the rear seatback. If the rear center seat belt is buckled when the left portion of the rear seatback is folded down, distortion and damage to the top portion of the seatback and seat belt garnish may result, causing the seatback to lock into the folded down position.

The seat belt should be locked into the buckle on each seat cushion to be properly fastened.



ODEEV058028NR

A: Rear right seat belt fastening buckle

B: Rear center seat belt fastening buckle

C: Rear left seat belt fastening buckle

⚠ WARNING

Prior to fastening the rear seat belts, ensure the latch matches the seat belt buckle. Forcefully fastening the left or right seat belt to the center buckle can result in an improper fastening scenario that will not protect you in an accident.

When using the rear center seat belt, the buckle with the "CENTER" mark must be used.

Stowing the rear seat belt

Outboard belt



ODEEV058029NR



ODEEV058031NR

Center belt



ODEEV058032NR

To release the seat belt:



ODEEV058078NR

- The seat belt is released by pressing the release button (1) on the locking buckle. When it is released, the belt should automatically draw back into the retractor. If this does not happen, check the belt to make sure it is not twisted, then try again.

If the center seat belt is not in use, always lock the latch plate into the buckle as above illustration.

The rear seat belt buckles can be stowed in the pocket between the rear seatback and cushion when not in use.

1. Insert the seat belt into the two holes (A) located on both sides. It will help keep the belts from being trapped behind or under the seats.

2. After inserting the seat belt, tighten the belt webbing by pulling it up.

Pre-tensioner seat belt

Your vehicle is equipped with driver's and front passenger's pre-tensioner seat belts (retractor pre-tensioner and EFD (Emergency Fastening Device)).



The pre-tensioner seat belts may be activated, when a frontal collision is severe enough, together with the air bags.

When the vehicle stops suddenly, or if the occupant tries to lean forward too quickly, the seat belt retractor may lock into position. In certain frontal collisions, the pre-tensioner will activate and pull the seat belt into tighter contact against the occupant's body.

1. Retractor pre-tensioner
The purpose of the retractor pre-tensioner is to make sure that the shoulder belts fit in tightly against the occupant's upper body in certain frontal collisions.
2. EFD (Emergency Fastening Device)
The purpose of the EFD is to make sure that the pelvic belts fit in tightly against the occupant's lower body in certain frontal collisions.

If the system senses excessive tension on the driver or passenger's seat belt when the pre-tensioner system activates, the load limiter inside the retractor pre-tensioner will release some of the pressure on the affected seat belt.

* NOTICE

When the pre-tensioner seat belts are activated, a loud noise may be heard and fine dust, which may appear to be smoke, may be visible in the passenger compartment. These are normal operating conditions and are not hazardous.

The seat belt pre-tensioner system consists mainly of the following components. Their locations are shown in the illustration:

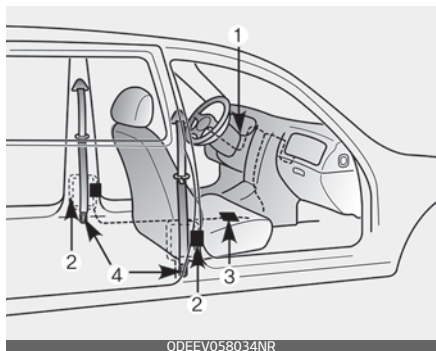

* The actual position of seat belt pre-tensioner system components may differ from the illustration.

1. SRS air bag warning light
2. Retractor pre-tensioner assembly
3. SRS control module
4. Emergency fastening device (EFD)

⚠ WARNING

Skin Irritation

Wash all exposed skin areas thoroughly after an accident in which the pre-tensioner seat belts were activated. The fine dust from the pre-tensioner activation may cause skin irritation and should not be inhaled for prolonged periods.

*** NOTICE**

- Both the driver's and front passenger's seat belt pre-tensioner systems may be activated not only in certain frontal collisions, but also in certain side collisions or rollovers, if the vehicle is equipped with a side or curtain air bag.
- Because the sensor that activates the SRS air bag is connected with the pre-tensioner seat belt, the SRS air bag warning light  on the instrument panel will illuminate for approximately 6 seconds after POWER button has been changed to ON position, and then it should turn off.

If the pre-tensioner seat belt system is not working properly, this warning light will illuminate even if there is not a malfunction with the SRS air bag. If the SRS air bag warning light does not illuminate when POWER button has been changed to ON, or if it remains illuminated after illuminating for approximately 6 seconds, or if it illuminates while the vehicle is being driven, have an authorized Kia dealer inspect the pre-tensioner seat belt and SRS air bag system as soon as possible.

*** NOTICE**

Do not attempt to service or repair the pre-tensioner seat belt system in any manner. Do not attempt to inspect or replace the pre-tensioner seat belts yourself. This must be done by an authorized Kia dealer.

⚠ WARNING**Hot pre-tensioner**

Do not touch the pre-tensioner seat belt assemblies for several minutes after they have been activated. When the pre-tensioner seat belt mechanism fires during a collision the pre-tensioner becomes hot and can burn you.

Pre-tensioners are designed to operate only one time. After activation, pre-tensioner seat belts must be replaced. If the pre-tensioner must be replaced, contact an authorized Kia dealer.

Seat belt precautions

Take the following precautions when using seat belts.

Infant or small child

All 50 states have child restraint laws. You should be aware of the specific requirements in your state. Child and/or infant seats must be properly placed and installed in the

rear seat. For more information about the use of these restraints, refer to "Child Restraint System (CRS)" on page 4-32.

*** NOTICE**

Small children are best protected from injury in an accident when properly restrained in the rear seat by a child restraint system that meets the requirements of the Federal Motor Vehicle Safety Standards. Before buying any child restraint system, make sure that it has a label certifying that it meets Federal Motor Vehicle Safety Standard 213. The restraint must be appropriate for your child's height and weight. Check the label on the child restraint for this information. Refer to "Child Restraint System (CRS)" on page 4-32.

Larger children

Children who are too large for child restraint systems should always occupy the rear seat and use the available lap/shoulder belts. The lap portion should be fastened and snug on the hips as low as possible. Check periodically to insure that the belt fits. A child's squirming could put the belt out of position. Children are given the most safety in the event of an accident when they are restrained by a proper restraint

system in the rear seat. If a larger child (over age 13) must be seated in the front seat, the child should be securely restrained by the available lap/shoulder belt and the seat should be placed in the rearmost position. Children age 13 and under should be restrained securely in the rear seat. NEVER place a child age 13 and under in the front seat. NEVER place a rear facing child seat in the front seat of a vehicle.

If the shoulder belt portion slightly touches the child's neck or face, try placing the child closer to the center of the vehicle. If the shoulder belt still touches their face or neck they need to be returned to a child restraint system.

WARNING

Small children

Do not allow small children to ride in the vehicle without an appropriate child restraint system. If the shoulder belt comes in contact with your child's neck or face your child is too small to ride in the vehicle. In a crash the seat belt will inflict injury to your child's neck, throat and face.

Restraint of pregnant women

Pregnant women should wear lap/shoulder belt assemblies whenever possible according to specific rec-

ommendations by their doctors. The lap portion of the belt should be worn AS SECURELY AND LOW AS POSSIBLE.

WARNING

Pregnant women

Pregnant women must never place the lap portion of the seat belt above or on the abdomen where the fetus is located. The force of the seat belt during a collision will crush the fetus.

Injured person

A seat belt should be used when an injured person is being transported. When this is necessary, you should consult a physician for recommendations.

One person per belt

Two people (including children) should never attempt to use a single seat belt. This could increase the severity of injuries in case of an accident.

Do not lie down

To reduce the chance of injuries in the event of an accident and to achieve maximum effectiveness of the restraint system, all passengers should be sitting up and the front and rear seats should be in an

upright position when the vehicle is moving. A seat belt cannot provide proper protection if the person is lying down in the rear seat or if the front and rear seats are in a reclined position.

Care of seat belts

Seat belt systems should never be disassembled or modified. In addition, care should be taken to assure that seat belts and belt hardware are not damaged by seat hinges, doors or other abuse.

WARNING

Pinched seat belt

Make sure that the webbing and/or buckle does not get caught or pinched in the rear seat when returning the rear seatback to its upright position. A caught or pinched webbing/buckle may become damaged and could fail during a collision or sudden stop.

WARNING

Seatbelts can become hot in a vehicle that has been closed up in sunny weather. They could burn infants and children.

Periodic inspection

All seat belts should be inspected periodically for wear or damage of any kind. Any damaged parts should be replaced as soon as possible.

Keep belts clean and dry

Seat belts should be kept clean and dry. If belts become dirty, they can be cleaned by using a mild soap solution and warm water. Bleach, dye, strong detergents or abrasives should not be used because they may damage and weaken the fabric.

When to replace seat belts

The entire in-use seat belt assembly or assemblies should be replaced if the vehicle has been involved in an accident. This should be done even if no damage is visible. Additional questions concerning seat belt operation should be directed to an authorized Kia dealer.

Child Restraint System (CRS)

Infants and younger children must be restrained in an appropriate rear-facing or forward-facing CRS that has first been properly secured to the rear seat of the vehicle.

Children always in the rear

Children under age 13 must always ride in the rear seats and must always be properly restrained to minimize the risk of injury in an accident, sudden stop or sudden maneuver.

WARNING

Restraint Location

Never install a child or infant seat on the front passenger's seat. A child riding in the front passenger seat can be forcefully struck by an inflating airbag and seriously injured.

WARNING

Hot Child Restraint

A child restraint system can become very hot if it is left in a closed vehicle on a sunny day. Be sure to check the seat cover, buckles and latches before placing a child in the restraint system.

According to accident statistics, children are safer when properly restrained in the rear seats than in the front seat. Even with air bags, children can be seriously injured or killed. Children too large for a child restraint must use the seat belts provided.

All 50 states have child restraint laws which require children to travel in approved child restraint devices. The laws governing the age or height/weight restrictions at which seat belts can be used instead of child restraints differs among states, so you should be aware of the specific requirements in your state, and where you are travelling.

Child restraint systems must be properly placed and installed in the rear seat. You must use a commercially available child restraint system that meets the requirements of the Federal Motor Vehicle Safety Standards (FMVSS).

Child restraint systems are generally designed to be secured in a vehicle seat by lap belt portion of a lap/shoulder belt, or by a LATCH system in the rear seats of the vehicle.

Child restraint system (CRS)

Infants and younger children must be restrained in an appropriate rear-facing or forward-facing CRS that has first been properly secured to the rear seat of the vehicle. Read and comply with the instructions for installation and use provided by the manufacturer of the CRS.

⚠ WARNING

Child Restraint Installation

An improperly secured child restraint can increase the risk of serious injury or death in an accident. Always take the following precautions when using a child restraint system:

- Always follow the child restraint system manufacturer's instructions for installation and use.
- Always properly restrain your child in the child restraint.
- If the vehicle head restraint prevents proper installation of a child seat (as described in the child restraint system manual), the head restraint of the respective seating position shall be readjusted or entirely removed.
- Do not use an infant carrier or a child safety seat that "hooks" over a seatback as it may not provide adequate protection in an accident.

*** NOTICE**

After an accident, have a Kia dealer check the child restraint system, seat belts, tether anchors and lower anchors.

Selecting a Child Restraint System (CRS)

When selecting a CRS for your child, always:

- Make sure the CRS has a label certifying that it meets applicable Federal Motor Vehicle Safety Standards (FMVSS 213).
- Select a child restraint based on your child's height and weight. The required label or the instructions for use typically provide this information.
- Select a child restraint that fits the vehicle seating position where it will be used.
- Read and comply with the warnings and instructions for installation and use provided with the child restraint system.

⚠ WARNING

Holding Children

Never hold a child in your arms or lap when riding in a vehicle. The violent forces created during a crash will tear the child from your arms and throw the child against the car's interior. Always use a child restraint system which is appropriate for your child's height and weight.

⚠ WARNING

Unattended Children

Never leave children unattended in a vehicle. The car can heat up very quickly, resulting in injuries to the child in the vehicle.

⚠ WARNING

Seat Belt Use

Do not use one seat belt for two occupants at the same time. This will eliminate any safety benefit provided by the seat belt to the occupants.

Child restraint system types

There are three main types of child restraint systems: rear-facing seats, forward-facing seats, and booster seats. They are classified according to the child's age, height and weight.

Rear-facing child seats



A rear-facing child seat provides restraint with the seating surface against the back of the child. The harness system holds the child in place, and in an accident, acts to keep the child positioned in the seat and reduces the stress to the neck and spinal cord.

All children under age one must always ride in a rear-facing infant child restraint.

Convertible and 3-in-1 child seats typically have higher height and weight limits for the rear-facing position, allowing you to keep your child rear-facing for a longer period of time.

Continue to use a rear-facing child seat for as long as your child will fit within the height and weight limits allowed by the child seat manufacturer. It's the best way to keep them safe. Once your child has outgrown the rear-facing child restraint, your child is ready for a forward-facing child restraint with a harness.

Forward-facing child restraints



A forward-facing child seat provides restraint for the child's body with a harness. Keep children in a forward-facing child seat with a harness until they reach the top height or weight limit allowed by your child restraint's manufacturer.

Once your child outgrows the forward-facing child restraint, your child is ready for a booster seat.

Booster seats

A booster seat is a restraint designed to improve the fit of the vehicle's seat belt system. A booster seat positions the seat belt so that it fits properly over the lap of your child.

Keep your child in a booster seat until they are big enough to sit in the seat without a booster and still have the seat belt fit properly. For a seat belt to fit properly, the lap belt must lie snugly across the upper thighs, not the stomach. The shoulder belt should lie snug across the shoulder and chest and not across the neck or face. Children under age 13 must always ride in the rear seats and must always be properly restrained to minimize the risk of injury.

Installing a Child Restraint System (CRS)

After selecting a proper child seat for your child, check to make sure it fits properly in your vehicle.

Follow the instructions provided by the manufacturer when installing the child seat. Note these general steps when installing the seat to your vehicle:

- **Properly secure the child restraint to the vehicle.** All child restraints must be secured to the vehicle with the lap part of a lap/shoulder belt or with the LATCH system.
- **Make sure the child restraint is firmly secured.** After installing a child restraint to the vehicle, push and pull the seat forward and from side-to-side to verify that it is securely attached to the seat. A child restraint secured with a seat belt should be installed as firmly as possible. However, some side-to-side movement can be expected.
- **Secure the child in the child restraint.** Make sure the child is properly strapped in the child restraint according to the manufacturer instructions.

Lower Anchors and Tether for Children (LATCH) System

The LATCH system holds a child restraint during driving and in an accident. This system is designed to make installation of the child restraint easier and reduce the possibility of improperly installing your child restraint. The LATCH system uses anchors in the vehicle and attachments on the child restraint. The LATCH system eliminates the need to use seat belts to secure the child restraint to the rear seats.

Lower anchors are metal bars built into the vehicle. There are two lower anchors for each LATCH seating position that will accommodate a child restraint with lower attachments.

To use the LATCH system in your vehicle, you must have a child restraint with LATCH attachments.

The child seat manufacturer will provide you with instructions on how to use the child seat with its attachments for the LATCH lower anchors.



LATCH anchors have been provided in the left and right outboard rear seating positions. Their locations are shown in the illustration. There are no LATCH anchors provided for the center rear seating position.

⚠ WARNING

LATCH Lower Anchors

Never attempt to attach a LATCH equipped seat in the center seating position. LATCH lower anchors are only to be used in the left and right rear outboard seating positions. You may damage the anchors or the anchors may fail and break in a collision if the seat is in the center seating position.

The lower anchor position indicator symbols are located on the left and right rear seatbacks to identify the position of the lower anchors in your vehicle (see arrows in illustration).



1. Lower Anchor position indicator
2. Lower Anchor

The LATCH anchors are located between the seatback and the seat cushion of the rear seat left and right outboard seating positions.

To use the lower anchor, push the upper portion of the lower anchor cover.

Securing a child restraint with the LATCH anchors system

To install a LATCH-compatible child restraint in either of the rear outboard seating positions:

1. Move the seat belt buckle away from the lower anchors.
2. Move any other objects away from the anchors that could prevent a secure connection between the child restraint and the lower anchors.
3. Place the child restraint on the vehicle seat, then attach the seat to the lower anchors according to the instructions provided by the child restraint manufacturer.

4. Follow the child restraint instructions for properly adjusting and tightening the lower attachments on the child restraint to the lower anchors.

⚠ WARNING

Take the following precautions when using the LATCH system:

- Read and follow all installation instructions provided with your child restraint system.
- To prevent the child from reaching and taking hold of the unused seat belts, buckle all unused rear seat belts before the child is placed into the vehicle. Lock each unused seatbelt following the instructions in the "automatic locking mode" subsection, and place the webbing behind the child seat or against an unused seatback. Children can be strangled if a shoulder belt becomes wrapped around their neck and the seat belt tightens.
- NEVER attach more than one child restraint to a single anchor. This could cause the anchor or attachment to come loose or break.
- Always have the LATCH system inspected by your authorized Kia dealer after an accident. An accident can damage the LATCH system and may not properly secure the child restraint.

*** NOTICE**

The recommended maximum weight for the LATCH system is 65 lbs. (30 kg). When selecting a proper child restraint, consider that the maximum total weight of the child plus the child restraint should be less than 65 lbs. (30 kg).

As a guide, the MAX child restraint weight should be determined by the following calculation:

Child Restraint Weight = 65 - (child's total weight in lbs.)

Securing a child restraint seat with "Tether Anchor" system



0DEEV058039NR

First secure the child restraint with the LATCH lower anchors or the seat belt. If the child restraint manufacturer recommends that the top tether strap be attached, attach and tighten the top tether strap to the top tether strap anchor.

Child restraint hook holders are located on the shelf behind the rear seats.

⚠ WARNING

Take the following precautions when installing the tether strap:

- Read and follow all installation instructions provided with your child restraint system.
 - NEVER attach more than one child restraint to a single tether anchor. This could cause the anchor or attachment to come loose or break.
 - Do not attach the tether strap to anything other than the correct tether anchor. It may not work properly if attached to something else.
 - Do not use the tether anchors for adult seat belts or harnesses, or for attaching other items or equipment to the vehicle.
 - Always fasten the seat belts behind the child restraint seat when they are not used to secure the child seat. Failure to do so may result in child strangulation.
-

To install the tether anchor:



ODEEV058040NR

1. Route the child restraint tether strap over the child restraint seatback. Route the tether strap under the head restraint and between the head restraint posts, or route the tether strap over the top of the vehicle seatback. Make sure the strap is not twisted.
2. Connect the tether strap hook to the tether anchor, then tighten the tether strap according to the child seat manufacturer's instructions to firmly secure the child restraint to the seat.
3. Check that the child restraint is securely attached to the seat by pushing and pulling the seat forward and from side-to-side.

Securing a child restraint with a lap/shoulder belt

When not using the LATCH system, all child restraints must be secured to a vehicle rear seat with the lap part of a lap/shoulder belt.

Automatic locking mode



ODEEV058041NR

Since all passenger seat belts move freely under normal conditions and only lock under extreme or emergency conditions (emergency locking mode), you must manually pull the seat belt all the way out to shift the retractor to the "automatic locking" mode to secure a child restraint.

The "automatic locking" mode will help prevent the normal movement of the child in the vehicle from causing the seat belt to loosen and compromise the child restraint system.

To install a child restraint system on the rear seats, do the following:

1. Place the child restraint system on a rear seat and route the lap/shoulder belt around or through the child restraint, following the restraint manufacturer's instructions.
Be sure the seat belt webbing is not twisted.
2. Fasten the lap/shoulder belt latch into the buckle. Listen for the distinct "click" sound. Position the release button so that it is easy to access in case of an emergency.



ODEEV058042NR

3. Pull the shoulder portion of the seat belt all the way out. When the shoulder portion of the seat belt is fully extended, it will shift the retractor to the "automatic locking" (child restraint) mode.



ODEEV058043NR

4. Slowly allow the shoulder portion of the seat belt to retract and listen for an audible "clicking" or "ratcheting" sound. This indicates that the retractor is in the "automatic locking" mode. If no distinct sound is heard, repeat steps 3 and 4.



ODEEV058044NR

5. Remove as much slack from the belt as possible by pushing down on the child restraint system while feeding the shoulder belt back into the retractor.
6. Push and pull on the child restraint system to confirm that the seat belt is holding it firmly in place. If it is not, release the seat belt and repeat steps 2 through 6.

7. Double check that the retractor is in the "automatic locking" mode by attempting to pull more of the seat belt out of the retractor. If you cannot, the retractor is in the "automatic locking" mode.

If your CRS manufacturer instructs or recommends you to use a tether anchor with the lap/shoulder belt, refer to "Securing a child restraint with the LATCH anchors system" on page 4-37 for more information.

* NOTICE

When the seat belt is allowed to retract to its fully stowed position, the retractor will automatically switch from the "automatic locking" mode to the emergency lock mode for normal adult usage.

⚠ WARNING

Auto lock mode

Set the retractor to Automatic Lock mode when installing any child restraint system. If the retractor is not in the automatic locking mode, the child restraint can move when your vehicle turns or stops suddenly. A child can be seriously injured or killed if the child restraint is not properly anchored in the car, including manually pulling the seat belt all the way out to shift the retractor to the "Auto Lock" mode.

To remove the child restraint, press the release button on the buckle and then pull the lap/shoulder belt out of the restraint and allow the seat belt to retract fully.

Air bag – advanced supplemental restraint system

The appropriate air bags inflate instantly in the event of a serious frontal collision or side collision in order to help protect the occupants from serious physical injury.



ODEEV058045NR

* The actual air bags in the vehicle may differ from the illustration.

1. Driver's front air bag
2. Passenger's front air bag
3. Side air bag
4. Curtain air bag
5. Driver's knee air bag

Even in vehicles with air bags, you and your passengers must always wear the safety belts provided in order to minimize the risk and severity of injury in the event of a collision or rollover.

How does the air bag system operate?

- Air bags are activated (able to inflate if necessary) only when the POWER button has been changed to ON position or the vehicle is in the ready mode.
- The appropriate air bags inflate instantly in the event of a serious frontal collision or side collision in order to help protect the occupants from serious physical injury.
- Generally, air bags are designed to inflate based upon the severity of a collision and its direction. These two factors determine whether the sensors produce an electronic deployment / inflation signal.
- Air bags will inflate based upon the severity of a collision and its direction, etc. But Air bags will not inflate in every crash or collision situation.
- The front air bags will completely inflate and deflate in an instant. It is virtually impossible for you to see the air bags inflate during an accident. It is much more likely that you will simply see the deflated air bags hanging out of their storage compartments after the collision.
- In addition to inflating in serious side collisions, side and/or curtain air bags will inflate if the sensing system detects a rollover.
- When a rollover is detected, side and/or curtain air bags will remain inflated longer to help provide protection from ejection, especially when used in conjunction with the seat belts.
- In order to help provide protection, the air bags must inflate rapidly. The speed of the air bag inflation is a consequence of extremely short time in which to inflate the air bag between the occupant and the vehicle structures before the occupant impacts those structures. This speed of inflation reduces the risk of serious or life-threatening injuries and is thus a necessary part of the air bag design. However, air bag inflation can also cause injuries which can include facial abrasions, bruises and broken bones because the inflation speed also causes the air bags to expand with a great deal of force.
- **There are even circumstances under which contact with the steering wheel or passenger air bag can cause fatal injuries, especially if the occupant is positioned excessively close to the steering wheel or passenger air bag.**

⚠ WARNING**Airbag inflation**

Sit as far back as possible from the steering wheel while still maintaining comfortable control of the vehicle. A distance of at least 10" from your chest to the steering wheel is recommended. Failure to do so can result in airbag inflation injuries to the driver.

Noise and smoke

When inflated, the air bags make a loud noise and leave smoke and powder in the air inside the vehicle. This is normal and is a result of the ignition of the air bag inflator. After the air bag inflates, you may feel substantial discomfort in breathing due to the contact of your chest with both the seat belt and the air bag, as well as from breathing the smoke and powder. **Open your doors and/or windows as soon as possible after impact in order to reduce discomfort and prevent prolonged exposure to the smoke and powder.**

Though smoke and powder are non-toxic, it may cause irritation to the skin (eyes, nose and throat, etc). If this is the case, wash and rinse with cold water immediately and consult a doctor if the symptom persists.

⚠ WARNING**Hot components**

Do not touch the air bag storage area's internal components immediately after airbag inflation. The air bag related parts in the steering wheel, instrument panel and the roof rails above the front and rear doors are very hot. Hot components can result in burn injuries.

⚠ WARNING

Do not install or place any accessories near air bag deployment areas, such as the instrument panel, windows, pillars, and roof rails.

Do not install a child restraint on the front passenger's seat

Never place a rear-facing child restraint in the front passenger's seat.



If the air bag deploys, it would impact the rear-facing child restraint, causing serious or fatal injury.

In addition, do not place front-facing child restraints in the front passenger's seat. If the front passenger air bag inflates, it could cause serious or fatal injuries to the child.

⚠ WARNING

Air bag deployment

When children are seated in the rear outboard seats of a vehicle equipped with side and/or curtain air bags, install the child restraint system as far away from the door side as possible. Inflation of the side and/or curtain air bags could impact the child.

Air bag warning light

The purpose of air bag warning light in your instrument panel is to alert you of a potential problem with your air bag system, which could include your side and/or curtain air bags used for rollover protection.

If the air bag warning light is illuminated for more than 6 seconds after POWER button has been changed to ON, or of it illuminates during vehicle operation, an SRS component may not be functioning properly and you

should have your vehicle checked by an authorized Kia dealer.



If any of the following conditions occur, this indicates a malfunction in the air bag system. Have an authorized Kia dealer inspect the air bag system as soon as possible.

- The light does not turn on briefly when you change POWER button to ON.
- The light stays on after illuminating for approximately 6 seconds.
- The light comes on while the vehicle is in motion.
- The light blinks when POWER button is ON position.

Supplemental Restraint System (SRS) components and functions

The SRS consists of multiple elements and sensors.

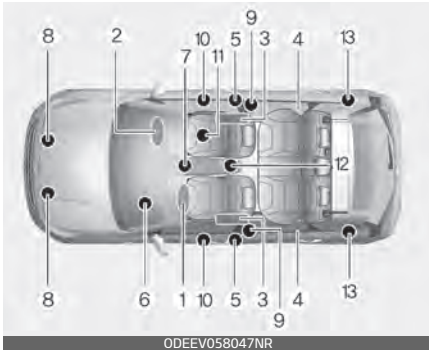

ODEEV058047NR

* The actual position of SRS components may differ from the illustration.

The SRS consists of the following components:

1. Driver's front air bag module
2. Passenger's front air bag module
3. Side air bag modules
4. Curtain air bag modules
5. Retractor pre-tensioner assemblies (if equipped)
6. Air bag warning light
7. SRS control module (SRSCM)
8. Front impact sensors
9. Side impact sensors (if equipped)
10. Side pressure sensors (if equipped)
11. Occupant detection system (Front passenger's seat only)
12. Front passenger's seat belt buckle sensor
13. Retractor pre-tensioner assemblies (if equipped)

*: if equipped

Driver's front air bag (1)



ODEEV058048NR

The front air bag modules are located both in the center of the steering wheel and in the front passenger's panel above the glove box. When the SRSCM detects a sufficiently severe impact to the front of the vehicle, it will automatically deploy the front air bags.

Driver's front air bag (2)



ODEEV058049NR

Upon deployment, tear seams molded directly into the pad covers will separate under pressure from the expansion of the air bags. Fur-

ther opening of the covers then allows full inflation of the air bags.

Driver's front air bag (3)



ODEEV058050NR

A fully inflated air bag, in combination with a properly worn seat belt, slows the driver's or the passenger's forward motion, reducing the risk of head and chest injury.

After complete inflation, the air bag immediately starts deflating, enabling the driver to maintain forward visibility and the ability to steer or operate other controls.

Passenger's front air bag



ODEEV058051NR

⚠ WARNING

Air bag obstructions

Do not install or place any accessories on the steering wheel, instrument panel, or on the front passenger's panel above the glove box in a vehicle. Such objects may become dangerous projectiles if the air bag deploys.

⚠ WARNING

Flying objects

Do not place any objects (an umbrella, bag, etc.) between the front door and the front seat. Such objects may become dangerous projectiles if the side airbag inflates.

- If an air bag deploys, there may be a loud noise followed by a fine dust released in the vehicle. These conditions are normal and are not hazardous - the air bags are packed in this fine powder. The dust generated during air bag deployment may cause skin or eye irritation as well as aggravate asthma for some persons. Always wash all exposed skin areas thoroughly with cold water and a mild soap after an accident in which the air bags were deployed.

- The SRS can function only when POWER button is ON position. If the SRS air bag warning light does not illuminate, or continuously remains on after illuminating for about 6 seconds when POWER button is ON position, or after the vehicle is in the ready mode, comes on while driving, the SRS is not working properly. If this occurs, have your vehicle immediately inspected by an authorized Kia dealer.

*** NOTICE**

Before you replace a fuse or disconnect a battery terminal, change POWER button to the OFF position. Never remove or replace the air bag related fuse(s) when POWER button is ON position. Failure to heed this warning will cause the SRS air bag warning light to illuminate.

Occupant Detection System (ODS)

Your vehicle is equipped with an occupant detection system in the front passenger's seat.



ODEEV058052NR

The occupant detection system is designed to detect the presence of a properly-seated front passenger and determine if the passenger's front air bag should be enabled (may inflate) or not. Only the front passenger front air bag is controlled by the Occupant Detection System.

Do not put anything in front of the passenger air bag "OFF" indicator.

Main components of the occupant detection system

- An detection device located within the front passenger seat cushion.
- An electronic system which determines whether the passenger air bag systems should be activated or deactivated.
- An indicator light located on the instrument panel which illuminates the words PASSENGER AIR BAG "OFF" indicates the front passenger air bag system is deactivated.
- The instrument panel air bag warning light is interconnected with the occupant detection system.

If the front passenger seat is occupied by a person that the system determines to be of appropriate size, and he/she sits properly (sitting upright with the seatback in an upright position, centered on the seat cushion with their seat belt on, legs comfortably extended and their feet on the floor), the PASSENGER AIR BAG "OFF" indicator will turn off and the front passenger's air bag will be able to inflate, if necessary, in frontal crashes.

You will find the PASSENGER AIR BAG "OFF" indicator on the center facia panel. This system detects the conditions 1~4 in the following table and activates or deactivates the front passenger air bag based on these conditions.

Always be sure that you and all vehicle occupants are seated and restrained properly (sitting upright with the seat in an upright position, centered on the seat cushion, with the person's legs comfortably extended, feet on the floor, and wearing the safety belt properly) for the most effective protection by the air bag and the safety belt.

- The ODS (Occupant Detection System) may not function properly if the passenger takes actions which can defeat the detection system. These include:
 1. Failing to sit in an upright position.
 2. Leaning against the door or center console.
 3. Sitting towards the sides or the front of the seat.
 4. Putting legs on the dashboard or resting them on other locations which reduce the passenger weight on the front seat.
 5. Improperly wearing the safety belt.
 6. Reclining the seatback.

Condition and operation in the front passenger occupant detection system

Condition detected by the occupant classification system	Indicator/Warning light		Devices
	"PASSENGER AIR BAG OFF" indicator light	SRS warning light	Front passenger air bag
1. Adult* ¹	Off	Off	Activated
2. Child restraint system with child under 12 months old * ² * ³ * ⁴	On	Off	Deactivated
3. Unoccupied	On	Off	Deactivated
4. Malfunction in the system	Off	On	Activated

*1. The system judges a person of adult size as an adult. When a smaller adult sits in the front passenger seat, the system may recognize him/her as a child depending on his/her physique and posture.

*2. Do not allow children to ride in the front passenger seat. When a larger child who has outgrown a child restraint system sits in the front passenger seat, the system may recognize him/her as an adult depending upon his/her physique or sitting position.

*3. Never install a child restraint system on the front passenger seat.

*4. The PASSENGER AIR BAG "OFF" indicator may turn on or off when a child above 12 months to 12 years old (with or without child restraint system) sits in the front passenger seat. This is a normal condition.

⚠ WARNING

- Do not install a child restraint seat in the passenger seat when the seat is heavily soaked with any type of liquid.
- Do not alter or remodel the ODS (Occupant Detection System). This may damage the system and prevent its proper function in a collision.

*** NOTICE**

- Do not use car seat cushions that cover up the surface of the seat and aftermarket manufactured passenger seat heaters.
- After conducting car interior cleaning using steam or detergent, the seat should be dried properly. Afterward, check for normal operation of the PASSENGER AIR BAG "OFF" and air bag warning lights.
- Any service related to the passenger seat and the ODS must be done at Kia service center.
- After the passenger seat has been removed or installed for repair purposes, check for normal operation of the PASSENGER AIR BAG "OFF" and air bag warning lights with a person seated or not seated in the passenger seat.

⚠ WARNING

When the PASSENGER AIR BAG "OFF" symbol is illuminated, the passenger air bag system will not operate. The passenger air bag system will operate when necessary if the symbol is not illuminated.

*** NOTICE**

Do not modify or replace the front passenger seat. Don't place anything on or attach anything such as a blanket, front seat cover or aftermarket seat heater to the front passenger seat. This can adversely affect the occupant detection system.

⚠ WARNING

ODS System

Riding in an improper position adversely affects the Occupant Detection System and may result in the deactivation of the front passenger airbag. It is important for the driver to instruct the passenger as to the proper seating instructions as contained in this manual.

- Do not place a heavy load in the front passenger seatback pocket or on the front passenger seat.



ODEEV058055NR

Safety features of your vehicle

- Do not place feet on the front passenger seatback.



ODEEV058056NR

- Never sit with hips shifted towards the front of the seat.



ODEEV058057NR

- Never excessively recline the front passenger seatback.



ODEEV058002NR

Air bag - advanced supplemental restraint system

- Never place feet on the dashboard.



ODEEV058059NR

- Never lean on the door or center console.
- Never sit on one side of the front passenger seat.



ODEEV058060NR

- Do not use car seat accessories such as thick blankets and cushions which cover up the car seat surface.

- Do not sit on the passenger seat wearing heavily padded clothes such as ski wear and hip protector.



ODEEV058061NR

- Do not place electronic devices such as laptops, DVD player, or conductive materials such as water bottles on the passenger seat.
- Do not use electronic devices such as laptops and satellite radios which use inverter chargers.



ODEEV058062NR

- Wet Passenger Seat
Do not spill liquid in the passenger seat. Spilled liquid on the passenger seat may cause the air bag warning light to illuminate or malfunction. If any liquid is spilled, make sure the seat has been completely dried before driving the vehicle.



ODEEV058063NR

Proper position



ODEEV058064NR

When an adult is seated in the front passenger seat, if the PASSENGER AIR BAG "OFF" indicator is on, change POWER button to the OFF position and ask the passenger to

sit properly (sitting upright with the seatback in an upright position, centered on the seat cushion with their seat belt on, legs comfortably extended and their feet on the floor). Restart the vehicle and have the person remain in that position. This will allow the system to detect the person and to enable the passenger air bag.

If the PASSENGER AIR BAG "OFF" indicator is still on, ask the passenger to move to the rear seat.

WARNING

PASSENGER AIR BAG "OFF" light

Do not allow an adult passenger to ride in the front seat when the PASSENGER AIR BAG "OFF" indicator is illuminated, because the air bag will not deploy in the event of a crash. The driver must instruct the passenger to reposition himself in the seat. Failure to properly position yourself may lead to air bag deactivation resulting in air bag non-deployment in a collision. If the PASSENGER AIR BAG "OFF" indicator remains illuminated after the passenger repositions themselves properly and the car is restarted, it is recommended that passenger move to the rear seat because the passenger's front air bag will not deploy.

* NOTICE

The PASSENGER AIR BAG "OFF" indicator illuminates for about 4 seconds after POWER button is turned to the ON position after the vehicle is started. If the front passenger seat is occupied, the occupant detection sensor will then classify the front passenger after several more seconds.

- Even though your vehicle is equipped with the occupant detection system, never install a child restraint system in the front passenger's seat. A deploying air bag can forcefully strike a child resulting in serious injuries or death.

Any child age 12 and under should ride in the rear seat. Children too large for child restraints should use the available lap/shoulder belts. No matter what type of crash, children of all ages are safer when restrained in the rear seat.

If the occupant detection system is not working properly, the SRS air bag warning light on the instrument panel will illuminate because the passenger's front air bag is connected with the occupant detection system. If there is a malfunction of the occupant detection system, the PASSENGER AIR BAG "OFF" indicator will not illuminate and the passen-

Safety features of your vehicle

ger's front air bag will inflate in frontal impact crashes even if there is no occupant in the front passenger's seat.

Driver's and passenger's front air bag

Your vehicle is equipped with an Advanced Supplemental Restraint (Air Bag) System and lap/shoulder belts at both the driver and passenger seating position.

Driver's front air bag



Driver's knee air bag



Air bag - advanced supplemental restraint system

Passenger's front air bag

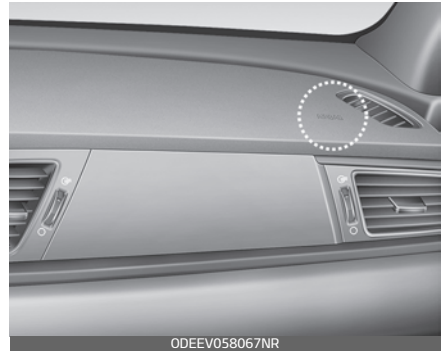

The indication of the system's presence are the letters "AIR BAG" located on the air bag pad cover on the steering wheel and the passenger's side front panel pad above the glove box.

The SRS consists of air bags installed under the pad covers in the center of the steering wheel and the passenger's side front panel above the glove box.

The purpose of the SRS is to provide the vehicle's driver and/or the front passenger with additional protection than that offered by the seat belt system alone in case of a frontal impact of sufficient severity. The SRS uses sensors to gather information about the driver's and front passenger's seat belt usage and impact severity.

The seat belt buckle sensor determines if the front passenger's seat belt is fastened.

These sensors provide the ability to control the SRS deployment based on whether or not the seat belts are fastened, and how severe the impact is.

The advanced SRS offers the ability to control the air bag inflation with two levels. A first stage level is provided for moderate-severity impacts. A second stage level is provided for more severe impacts.

The passenger's front air bag is designed to help reduce the injury of children sitting close to the instrument panel in low speed collisions. However, children are safer if they are restrained in the rear seat.

According to the impact severity and seat belt usage, the SRSCM (SRS Control Module) controls the air bag inflation. Failure to properly wear seat belts can increase the risk or severity of injury in an accident.

Additionally, your vehicle is equipped with an occupant detection system in the front passenger's seat. The occupant detection system detects the presence of a passenger in the front passenger's seat and will turn off the front passenger's air bag under certain conditions. For more detail, see "Occupant Detection System (ODS)" on page 4-48.

WARNING

Modification

Modification to the seat structure can cause the air bag to deploy at a different level than should be provided.

Manufacturers are required by government regulations to provide a contact point concerning modifications to the vehicle for persons with disabilities, which modifications may affect the vehicle's advanced air bag system. That contact is Kia's toll-free Customer Assistance center at 1-800-333-4Kia. However, Kia does not endorse nor will it support any changes to any part or structure of the vehicle that could affect the advanced air bag system, including the occupant detection system.

WARNING

Replacement/modifications

The front passenger seat, dashboard or door should not be replaced except by an authorized Kia dealer using original Kia parts designed for this vehicle and model. Any other such replacement or modification could adversely affect the operation of the occupant detection system and your advanced air bags.

⚠ WARNING**Modification**

Modification to the seat structure can cause the air bag to deploy at a different level than should be provided.

Advanced air bags are combined with pre-tensioner seat belts to help provide enhanced occupant protection in frontal crashes. Front air bags are not intended to deploy in collisions in which sufficient protection can be provided by the seat belt.

*** NOTICE**

Air bags can only be used once – have an authorized Kia dealer replace the air bag immediately after deployment.

Front air bags are not intended to deploy in side-impact, rear-impact or rollover crashes. However, when frontal deployment threshold is satisfied at side-impact, front air bags may deploy. In addition, front air bags will not deploy in frontal crashes below the deployment threshold.

⚠ WARNING**SRS Wiring**

Do not tamper with or disconnect SRS wiring or other components of the SRS system. Doing so could result in injury, due to accidental deployment of the air bags or by rendering the SRS inoperative.

⚠ WARNING**No attaching objects**

No objects (such as crash pad cover, cellular phone holder, cup holder, perfume or stickers) should be placed over or near the air bag modules on the steering wheel, instrument panel, windshield glass, and the front passenger's panel above the glove box. Such objects could cause harm if the vehicle is in a crash severe enough to cause the air bags to deploy.

Do not place any objects over the air bag or between the air bag and yourself.

Side air bag

Your vehicle is equipped with a side air bag in each front seat.



ODEEV058068NR



ODEEV058069NR

* The actual air bags in the vehicle may differ from the illustration.

The purpose of the air bag is to provide the vehicle's driver and/or the front passenger with additional protection than that offered by the seat belt alone.

- The side air bags are designed to deploy during certain side-impact collisions, depending on the crash severity of impact.

- The side air bags may deploy on the side of the impact or on both sides.
- The side and/or curtain air bags on both sides of the vehicle will deploy if a rollover or possible rollover is detected.
- The side air bags are not designed to deploy in all side impact or rollover situations.

⚠ WARNING

Unexpected deployment

Avoid impact to the side impact air-bag sensor when POWER button is ON to prevent unexpected deployment of the side air bag.

- The side air bag is supplemental to the driver's and the passenger's seat belt systems and is not a substitute for them. Therefore your seat belts must be worn at all times while the vehicle is in operation.
- For best protection from the side air bag system and to avoid being injured by the deploying side air bag, both front seat occupants should sit in an upright position with the seat belt properly fastened. The driver's hands should be placed on the steering wheel at the 9:00 and 3:00 positions. The passenger's arms and hands should be placed on their laps.

⚠ WARNING**Deployment**

Do not install any accessories including seat covers, on the side or near the side air bag as this may affect the deployment of the side air bags.

- If seat or seat cover is damaged, have the vehicle checked and repaired by an authorized Kia dealer. Inform the dealer that your vehicle is equipped with side air bags and an occupant detection system.

⚠ WARNING**Flying objects**

Do not place any objects (an umbrella, bag, etc.) between the front door and the front seat. Such objects may become dangerous projectiles if the side airbag inflates.

⚠ WARNING**No attaching objects**

- Do not place any objects over the air bag or between the air bag and yourself. Also, do not attach any objects around the area the air bag inflates such as the door, side door glass, front and rear pillar.
- Do not put any objects between the side airbag label and seat cushion. It could cause harm if the vehicle is in a crash severe enough to cause the air bags to deploy.
- Never place or insert any object into any small opening near side airbag labels attached to the vehicle seats. When the air bag deploys, the object may affect the deployment and result in unexpected accident or bodily harm.
- Do not install any accessories on the side or near the side air bags.

Curtain air bag

Curtain air bags are located along both sides of the roof rails above the front and rear doors.

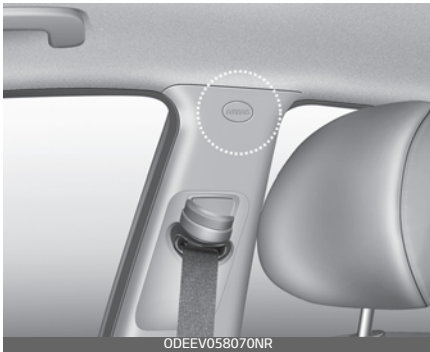

* The actual air bags in the vehicle may differ from the illustration.

They are designed to help protect occupants in certain side impacts and to help prevent them from ejecting out of the vehicle as a result of a rollover, especially when the seatbelts are also in use.

- The curtain air bags are designed to deploy during certain side impact collisions, depending on the severity of impact. However, when side deployment threshold is satisfied at front-impact, side air bags may deploy.

- The curtain air bags may deploy on the side of the impact or on both sides.
- Also, the curtain air bags on both sides of the vehicle will deploy in certain rollover situations.
- The curtain air bags are not designed to deploy in all side impact or rollover situations.

Do not allow the passengers to lean their heads or bodies against the doors, put their arms on the doors, stretch their arms out of the window or place objects between the doors and passengers when they are seated on seats equipped with side impact and/or curtain air bags.

*** NOTICE**

Never try to open or repair any components of the side and curtain air bag system. This should only be done by an authorized Kia dealer.

⚠ WARNING

No attaching objects

- Do not place any objects over the air bag. Also, do not attach any objects around the area the air bag inflates such as the door, side door glass, front and rear pillar, roof side rail.
- Do not hang hard, breakable, or heavy objects on the coat hooks for safety reasons.

Air bag collision sensors

The air bag collision sensors are located in the following positions



* The actual shape and position of sensors may differ from the illustration.

1. SRS control module / Rollover sensor
2. Front impact sensor
3. Side pressure sensor
4. Side impact sensor

⚠ WARNING**Air bag sensors**

- Do not hit or allow any objects to impact the locations where air bags or sensors are installed. This may cause unexpected air bag deployment, which could result in serious personal injury or death.
- If the installation location or angle of the sensors is altered in any way, the air bags may deploy when they should not or they may not deploy when they should.

Therefore, do not try to perform maintenance on or around the air bag sensors. Have the vehicle checked and repaired by an authorized Kia dealer.

Problems may arise if the sensor installation angles are changed due to the deformation of the front bumper, front end module, body or front doors where side collision sensors are installed. Have the vehicle checked and repaired by an authorized Kia dealer.

Installing bumper guards (or side step or running board) or replacing a bumper (or front door module) with non-genuine parts may adversely affect your vehicle's collision and air bag deployment performance.

Why didn't my air bag go off in a collision? (Inflation and non-inflation conditions of the air bag)

There are many types of accidents in which the air bag would not be expected to provide additional protection.

These include rear impacts, second or third collisions in multiple impact accidents, as well as low speed impacts.

Air bag inflation conditions**Front air bags**

Front air bags are designed to inflate in a frontal collision depending on the severity of impact of the front collision.

Side and/or curtain air bags

Side and/or curtain air bags are designed to inflate when an impact is detected by side collision sensors depending on the severity of impact resulting from a side impact collision.

Also, the side and curtain air bags are designed to inflate when a rollover is detected by a rollover sensor. Although the front air bags (driver's and front passenger's air bags) are primarily designed to inflate in frontal collisions, they may inflate in other types of collisions if the front impact sensors detect a sufficient frontal force in another type of impact.

Similarly, although side and curtain air bags are designed to inflate in certain side impact collisions, they may inflate in other types of collisions where a side force is detected by the sensors. For instance, side air bag and/or curtain air bags may inflate if rollover sensors indicate the possibility of a rollover occurring (even if none actually occurs) or in other situations, including when the vehicle is tilted while being towed. Even if side and/or curtain air bags do not provide impact protection in a rollover, they will deploy to prevent ejection of occupants, especially those who are restrained with seat belts.

If the vehicle chassis is impacted by bumps or objects on unimproved roads, the air bags may deploy. Drive carefully on unimproved roads or on surfaces not designed for vehicle traffic to prevent unintended air bag deployment.

Air bag non-inflation conditions

- In certain low-speed collisions the air bags may not deploy. The air bags are designed not to deploy in such cases because they may not provide benefits beyond the protection of the seat belts in such collisions.

- Air bags are not designed to inflate in rear collisions, because occupants are moved backward by the force of the impact. In this case, inflated air bags would not be able to provide any additional benefit.
- Front air bags may not inflate in side impact collisions, because occupants move to the direction of the collision, and thus in side impacts, frontal air bag deployment would not provide additional occupant protection.
- In an angled collision, the force of impact may direct the occupants in a direction where the air bags would not be able to provide any additional benefit, and thus the sensors may not deploy any air bags.
- Just before impact, drivers often brake heavily. Such heavy braking lowers the front portion of the vehicle causing it to "ride" under a vehicle with a higher ground clearance. Air bags may not inflate in this "under-ride" situation because deceleration forces that are detected by sensors may be significantly reduced by such "under-ride" collisions.
- Front air bags may not inflate in all rollover accidents when the SRSCM indicates that the front air bag deployment would not provide additional occupant protection.

- Air bags may not inflate if the vehicle collides with objects such as utility poles or trees, where the point of impact is concentrated to one area and the full force of the impact is not delivered to the sensors.

Supplemental Restraint System (SRS) Care

The SRS is virtually maintenance-free and so there are no parts you can safely service by yourself.

If the SRS air bag warning light does not illuminate, or continuously remains on, have your vehicle immediately inspected by an authorized Kia dealer.

Any work on the SRS system, such as removing, installing, repairing, or any work on the steering wheel, the front passenger's panel, front seats and roof rails must be performed by an authorized Kia dealer. Improper handling of the SRS system may result in serious personal injury.

For cleaning the air bag pad covers, use only a soft, dry cloth or one which has been moistened with plain water. Solvents or cleaners could adversely affect the air bag covers and proper deployment of the system.

If components of the air bag system must be discarded, or if the vehicle

must be scrapped, certain safety precautions must be observed. An authorized Kia dealer knows these precautions and can give you the necessary information. Failure to follow these precautions and procedures could increase the risk of personal injury.

WARNING

Tampering with SRS

Do not tamper with or disconnect SRS wiring, or other components of the SRS system. Doing so could result in the accidental inflation of the air bags or by render the SRS inoperative.

WARNING

Towing Vehicle

Always have the ignition off when your vehicle is being towed. The side air bags may inflate if the vehicle is tilted such as when being towed because of the rollover sensors in the vehicle.

Adding equipment to or modifying your air bag-equipped vehicle

If you modify your vehicle by changing your vehicle's frame, bumper system, front end or side sheet metal or ride height, this may affect the operation of your vehicle's air bag system.

Air bag warning label

Air bag warning labels, some required by the U.S. National Highway Traffic Safety Administration (NHTSA), are attached to the sun visor to alert the driver and passengers of potential risks of the air bag system.



ODEEV058077NR

Smart key	5-6
• Replacing smart key battery	5-9
• Smart key immobilizer system.....	5-10
• This device complies with Part 15 of the FCC rules.	5-10
Theft-alarm system	5-11
• Armed stage.....	5-11
• Theft-alarm stage	5-12
• Disarmed stage.....	5-12
Door locks	5-13
Liftgate	5-18
• Opening the liftgate	5-18
• Closing the liftgate.....	5-18
• Opening the liftgate in emergency	5-19
Windows	5-20
• Window opening and closing	5-21
• Power window lock button	5-23
Hood	5-24
• Opening the hood	5-24
• Hood open warning	5-25
• Closing the hood	5-25
Sunroof	5-26
• Sliding the sunroof	5-28
• Tilting the sunroof	5-29
• Sunshade	5-30
• Resetting the sunroof	5-30
• Sunroof open warning	5-31
Steering wheel	5-31

5 Features of your vehicle

• Electronic power steering	5-31
• Tilt & telescopic steering wheel	5-32
• Adjusting steering wheel angle and height.....	5-33
• Heated steering wheel	5-33
• Horn	5-34
Mirrors	5-35
• Inside rearview mirror	5-35
• Outside rearview mirror	5-42
Charging door	5-45
• Opening the charging door.....	5-45
• Closing the charging door.....	5-45
Instrument cluster.....	5-46
• Instrument cluster control.....	5-47
• LCD display control.....	5-47
• Gauges.....	5-48
• Reduction gear	5-51
• Shift indicator pop-up	5-51
• Regenerative braking level indicator	5-51
• Utility mode	5-52
LCD display	5-53
• LCD Display Control	5-53
• LCD Display Modes	5-54
LCD displays.....	5-62
• Trip information (Trip computer).....	5-62
• Driving info display	5-65
Warning and indicator lights	5-73
• Warning lights	5-73
• Indicator lights	5-78
Parking distance warning-reverse.....	5-81

Parking distance warning	5-85
Rear view monitor	5-90
Lighting	5-91
• Battery saver function	5-91
• Headlight escort function	5-91
• Daytime running light	5-91
• Lighting control	5-92
• Operating high beam	5-93
• Operating turn signals and lane change signals	5-94
• Operating front fog light	5-94
• High Beam Assist	5-95
Wipers and washers	5-98
• Operating windshield washer	5-99
• Operating rear window wiper and washer switch	5-100
Interior lights	5-101
• Automatic turn off function	5-101
• Room lamp	5-101
• Map lamp	5-102
• Liftgate room lamp	5-103
• Vanity mirror lamp	5-103
Welcome system	5-104
Defroster	5-105
• Operating rear window defroster	5-105
• Outside mirror defroster	5-105
Automatic climate control system	5-106
• Heating and air conditioning automatically	5-107
• Manual heating and air conditioning	5-108
• Mode selection	5-109

5 Features of your vehicle

- Temperature control..... 5-110
- Controlling air intake..... 5-110
- Controlling fan speed..... 5-111
- Air conditioning..... 5-111
- Turning heating on or off..... 5-112
- Turning off the front air climate control..... 5-113
- Displaying climate information..... 5-113
- Air conditioning for driver only..... 5-113
- Automatic ventilation..... 5-113
- System operation..... 5-114
- Climate control air filter..... 5-116
- Checking the amount of air conditioner refrigerant and compressor lubricant..... 5-116
- Air Conditioning refrigerant label..... 5-117
- Windshield defrosting and defogging..... 5-117
- Storage compartment..... 5-121**
- Center console storage..... 5-121
- Glove box..... 5-121
- Sunglass holder..... 5-122
- Luggage box..... 5-122
- Interior features..... 5-123**
- Cup holder..... 5-123
- Seat warmer..... 5-124
- Air ventilation seat..... 5-125
- Sun visor..... 5-126
- Power outlet..... 5-127
- USB charger..... 5-128
- Wireless smart phone charging system..... 5-128
- Coat hook..... 5-132
- Floor mat anchor(s)..... 5-132

- Luggage net holder5-133
- Cargo security screen5-134
- Exterior features5-135**
- Roof rack.....5-135
- Audio system.....5-136**
- Antenna.....5-136
- USB port.....5-137
- How vehicle radio works.....5-137
- Declaration of Conformity5-140**
- FCC.....5-140

FEATURES OF YOUR VEHICLE

Smart key

The mechanical key and various remote functions are integrated into the smart key to provide convenience to the driver.



Record your key number



The key code number is stamped on the bar code tag attached to the key set. Should you lose your keys, this number will enable an authorized Kia dealer to duplicate the keys easily. Remove the bar code tag and store it in a safe place. Also, record the code number and keep it in a safe and handy place, but not in the vehicle.

Smart key function

To remove the mechanical key, press and hold the release button (1) and remove the mechanical key (2).

0DEEV068001NR

To reinstall the mechanical key, put the key into the hole and push it until a click sound is heard.

With a smart key, you can lock or unlock a door (and liftgate) and start the vehicle.

Refer to the following for more details.

⚠ WARNING

Smart key

Never leave the keys in your vehicle with unsupervised children. Leaving children unattended in a vehicle with the Smart key is dangerous even if the start button is not in the ACC or ON position. Children copy adults and they could press the start button. The key would enable children to operate power windows or other controls, or even make the vehicle move, which could result in serious bodily injury or death.

Locking



ODEEV068002NR

Pressing the button of the front outside door handles with all doors (and liftgate) closed and any door unlocked, locks all the doors (and liftgate).

The hazard warning lights will blink once to indicate that all doors (and liftgate) are locked. The button will only operate when the smart key is within 28~40 in (0.7~1 m) from the outside door handle. If you want to make sure that a door has locked or not, you should check the door lock button inside the vehicle or pull the outside door handle.

Even though you press the button, the doors will not lock and an audible chime will sound if any of the following occurs:

- The smart key is in the vehicle.
- The POWER button is in the ACC or ON position.
- Any door except the liftgate is opened.

Unlocking

Pressing the button of the front outside door handles with all doors (and liftgate) closed and locked, unlocks all the doors (and liftgate). The hazard warning lights will blink twice to indicate that all doors (and liftgate) are unlocked. The button will only operate when the smart key is within 28~40 in (0.7~1 m) from the outside door handle. When 2-press unlock function is activated,



ODEEV068235NR

- If you press the Door Unlock button (2) on the smart key, driver's door will unlock.
- If you press Door Unlock button (2) on the smart key within four seconds again, then all the doors will unlock.
- If you press the driver's outside door handle button, driver's door will unlock.
- If you press the driver's outside door handle button within four seconds again, then all the doors will unlock.

* NOTICE

You can activate or deactivate the 2-press unlock function. Refer to "User settings mode" on page 5-56.

Liftgate unlocking

If you are within 28~40 in (0.7~1 m) from the outside liftgate handle, with your smart key in possession, the liftgate will unlock and open when you press the liftgate handle switch.

The hazard warning lights will blink twice to indicate that the liftgate is unlocked.

Also, once the liftgate is opened and then closed, the liftgate will lock automatically.

Panic

1. Press the panic button (4) for more than 1 second.
2. The horn sounds and hazard warning light flash for about 27 seconds.

To stop the horn and lights, press any button on the smart key.

Start-up

You can start the vehicle without inserting the key.

* For information, refer to "Power button" on page 6-6.

Loss of the smart key

A maximum of 2 smart keys can be registered to a single vehicle.

If you happen to lose your smart key, you will not be able to start the vehicle. You should immediately take the vehicle and remaining key to your authorized Kia dealer (tow the vehicle, if necessary) to protect it from potential theft.

Smart key precautions

The smart key will not work if any of the following occur:

- The smart key is close to a radio transmitter such as a radio station or an airport which can interfere with normal operation of the smart key.
- The smart key is near a mobile two way radio system or a cellular phone.
- Another vehicle's smart key is being operated close to your vehicle.

When the smart key does not work correctly, open and close the door with the mechanical key and contact an authorized Kia dealer.

If the smart key is in close proximity to your cell phone or smart phone, the signal from the smart key could be blocked by normal operation of your cell phone or smart phone. This is especially important when the phone is active such as making calls, receiving calls, text messaging, and/or sending/receiving emails. Avoid placing the smart key and your cell

phone or smart phone in the same pants or jacket pocket and maintain adequate distance between the two devices.

⚠ CAUTION

Smart key

Keep the smart key away from water or any liquid, as it can become damaged and not function properly if wet.

* NOTICE

If the smart key is inoperative due to exposure to water or liquids, it will not be covered by your manufacturer's vehicle warranty.

Replacing smart key battery

A smart key battery should last for several years, but if the smart key is not working properly, try replacing the battery with a new one.

If you are unsure how to use your smart key or replace the battery, contact an authorized Kia dealer.

1. Remove the mechanical key.
2. Pry open the rear cover.
3. Replace the battery with a new battery (CR2032). When replacing the battery, make sure the battery is in the correct position.
4. Install the battery in the reverse order of removal.

The smart key is designed to give you years of trouble-free use, however it can malfunction if exposed to moisture or static electricity. If you are unsure how to use or replace the battery, contact an authorized Kia dealer.

Using the wrong battery can cause the smart key to malfunction. Be sure to use the correct battery.

To avoid damaging the smart key, don't drop it, get it wet, or expose it to heat or sunlight.



An inappropriately disposed battery can be harmful to the environment and human health. Dispose the battery according to your local law(s) or regulations.



⚠ CAUTION**Smart key damage**

Do not drop, get wet or expose the smart key to heat or sunlight, or it will be damaged.

Smart key immobilizer system

The immobilizer system protects your vehicle from theft. If an improperly coded key (or other device) is used, the vehicle's power system is disabled.

When the POWER button is placed in the ON position, the immobilizer system indicator should come on briefly, then go off. If the indicator starts to blink, the system does not recognize the coding of the key.

Place the POWER button to the OFF position, then place the POWER button to the ON position again.

In some circumstances, the vehicle may not recognize your smart key if another smart key device is nearby or a metal object such as a key chain is causing interference with the smart key.

If this occurs, your vehicle may not start. Remove any metal objects or additional keys near the smart key before attempting to start the vehicle again.

If the system repeatedly does not recognize the coding of the key, it is recommended that you contact your Kia dealer.

Do not attempt to alter this system or add other devices to it. Electrical problems could result that may make your vehicle inoperable.

*** NOTICE**

When starting the vehicle, do not use the key with other immobilizer keys around. Otherwise the vehicle may not start or may stop soon after it starts. Keep each key separate in order to avoid a starting malfunction.

This device complies with Part 15 of the FCC rules.

Operation is subject to the following two conditions:

1. This device may not cause harmful interference, and
2. This device must accept any interference received, including interference that may cause undesired operation.

* NOTICE

Changes or modifications not expressly approved by the party responsible for compliance could void the user's authority to operate the equipment. If the smart key is inoperative due to changes or modifications not expressly approved by the party responsible for compliance, it will not be covered by your manufacturer's vehicle warranty.

Theft-alarm system (if equipped)

This system is designed to provide protection from unauthorized entry into the vehicle.

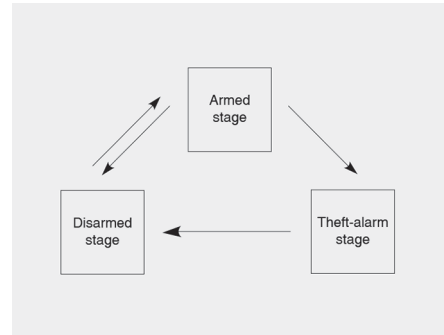

This system is operated in three stages: the first is the "Armed" stage, the second is the "Theft-alarm" stage, and the third is the "Disarmed" stage. If triggered, the system provides an audible alarm with blinking of the hazard warning lights.

Armed stage

Park and stop the vehicle. Arm the system as described below.

Entering the armed stage using the smart key

1. Place the POWER button in OFF position.
2. Make sure that all doors, the hood and liftgate are closed and latched.

3. Lock the doors by pressing the button of the front outside door handle with the smart key in your possession.

After completion of the steps above, the hazard warning lights will operate once to indicate that the system is armed.

If any door (or liftgate) or hood remains open, the hazard warning lights and the chime will not operate and the theft-alarm will not arm. If all doors and liftgate and hood are closed after the lock button is pressed, the hazard warning lights blink once.

The system can also be armed by locking the doors with the key from the front doors; however, the hazard warning lights will not blink using this method.

4. Lock the doors by pressing the lock button on the smart key. After completion of the steps above, the hazard warning lights will operate once to indicate that the system is armed.

* NOTICE

Do not arm the system until all passengers have left the vehicle. If the system is armed while a passenger(s) remains in the vehicle, the alarm may be activated when the remaining passenger(s) leaves the vehicle. If any door (or liftgate) or hood is opened within 30 seconds after the system enters the armed stage, the system will be disarmed to prevent unnecessary alarm.

Theft-alarm stage

The alarm will be activated if any of the following occurs while the system is armed.

- A front or rear door is opened without using the smart key.
- The liftgate is opened without using the smart key.
- The hood is opened.

The horn will sound and the hazard warning lights will blink continuously for approximately 27 seconds, and repeat the horn 3 times unless the system is disarmed. To turn off the system, unlock the doors with the smart key.

Disarmed stage

The system will be disarmed when:

- The doors (and liftgate) are unlocked with the smart key.

After pressing the unlock button, the hazard warning lights will blink and the chime will sound twice (in smart key) to indicate that the system is disarmed.

After pressing the unlock button, if any door (or liftgate) is not opened within 30 seconds, the system will be rearmed.

* NOTICE

- Avoid trying to start the vehicle while the alarm is activated. The vehicle starting motor is disabled during the theft-alarm stage. If the system is not disarmed with the smart key, open the doors by using the mechanical key and start the vehicle by directly pressing the POWER button with the smart key.
- If you lose your keys, consult your authorized Kia dealer.

⚠ CAUTION

Adjusting alarm system

Do not change, alter or adjust the theft alarm system in your vehicle. Improper installation of the alarm system could damage the vehicle or cause the system to malfunction.

* NOTICE

Malfunctions caused by improper alterations, adjustments or modifications to the theft-alarm system are not covered by your vehicle manufacturer warranty.

Door locks

Know how to use the door lock so that you can lock or unlock the door if necessary.

Operating door locks from outside the vehicle

Turn the key toward the rear of the vehicle to lock (1) and toward the front of the vehicle to unlock (2).



ODEEV068007NR

- If you lock the driver's door with a key, all vehicle doors will lock automatically (if equipped).
- From the driver's door, turn the key toward the front of the vehicle once to unlock the driver's door and once more within 4 seconds to unlock all doors.
- Doors can also be locked and unlocked with the smart key.
- Once the doors are unlocked, they may be opened by pulling the door handle.
- When closing the door, push the door by hand. Make sure the doors are closed securely.

* NOTICE

- In cold and wet climates, door lock and door mechanisms may not work properly due to freezing conditions.
- If the door is locked/unlocked multiple times in rapid succession with either the vehicle key or door lock switch, the system may stop operating temporarily in order to protect the circuit and prevent damage to system components.

⚠ WARNING

- Securely close your door before you begin driving. Failure to fully close your door may cause it to open during vehicle operation.
- Keep your body out of the way of the closing door to prevent injuries.

⚠ WARNING

If adult passengers must remain in the vehicle while it is very hot or cold outside, there is risk of injuries or danger to life. Do not lock the vehicle from the outside when there are adult passengers in the vehicle.

⚠ CAUTION

Do not unnecessarily open and close the door repeatedly or with excessive force. Such action can damage the vehicle door.

To lock a door without the key, push the inside door lock button (1) or central door lock switch (2) to the "Lock" position and close the door (3).



ODEEV068008NR

If you lock the door with the central door lock switch (2), all vehicle doors will lock automatically.

* NOTICE

Always turn the POWER button to OFF position, engage the parking brake, close all windows, and lock all doors when leaving your vehicle unattended.

Operating door locks from inside the vehicle

With the door lock button



ODEEV068009NR

- To unlock a door, pull the door lock button (1) to the "Unlock" position. The red mark on the door lock button will be visible.
- To lock a door, push the door lock button (1) to the "Lock" position. If the door is locked properly, the red mark on the door lock button will not be visible.
- To open a door, pull the door handle (2) outward.
- If the inner door handle of the driver's (or front passenger's) door is pulled when the door lock button is in the lock position, the button will unlock and the door will open.
- Doors cannot be locked if the smart key is in the vehicle and a door is open.

⚠ WARNING

Door lock malfunction

If a power door lock ever fails to function while you are in the vehicle, try one or more of the following techniques to exit:

- Operate the door unlock feature repeatedly (both electronic and manual) while simultaneously pulling on the door handle.
- Operate the other door locks and handles, front and rear.
- Lower a front window and use the key to unlock the door from outside.

⚠ WARNING

Do not pull the inner door handle of driver's (or passenger's) door while the vehicle is moving.

With central door lock switch

Driver side



ODEEV068010NR

Passenger side



ODEEV068011NR

Operate by pressing the central door lock switch.

- When pressing the right portion (1) for driver side or the upper portion (1) for passenger side of the switch, all vehicle doors will lock.
- When pressing the left portion (2) for driver side or the lower portion (2) for passenger side of the switch, all vehicle doors will unlock.
- If the smart key is in the vehicle and any door is opened, the doors will not lock even though the right portion (1) for driver side or upper portion (1) for passenger side of the central door lock switch is pressed.

⚠ WARNING

Doors

- The doors should always be fully closed and locked while the vehicle is in motion to prevent accidental opening of the door.
- Be careful when opening doors and watch for vehicles, motorcycles, bicycles or pedestrians approaching the vehicle in the path of the door. Opening a door when something is approaching can cause damage or injury.

⚠ WARNING

Unattended children/animals

Never leave children or animals unattended in your vehicle. An enclosed vehicle can become extremely hot, causing death or severe injury to unattended children or animals who cannot escape the vehicle.

Door lock/unlock features

Impact sensing door unlock system

All doors will automatically unlock when an impact causes the air bags to deploy.

Speed sensing door lock system

All doors will automatically lock after the vehicle speed exceeds 10 mph (15 km/h).

You can activate or deactivate the auto door lock/unlock features in the vehicle. Refer to "User settings mode" on page 5-56.

Child-protector rear door locks

The child safety lock is provided to help prevent children from accidentally opening the rear doors from inside the vehicle. The rear door safety locks should be used whenever children are in the vehicle.

The child safety lock is located on the edge of each rear door. When the child safety lock is in the lock position (1), the rear door will not open if the inner door handle (2) is pulled.

To allow a rear door to be opened from inside the vehicle, unlock the child safety lock.

WARNING

Rear door locks

Use the rear door safety locks whenever children are in the vehicle. If a child accidentally opens the rear doors while the vehicle is moving, he or she may fall out.



ODEEV068012NR

To lock the child safety lock, insert a key (or screwdriver) into the hole and turn it to the lock position.

Liftgate

When you open the liftgate, you will see a space where you can load the cargo.

Opening the liftgate

The liftgate is locked or unlocked when all doors are locked or unlocked with the key, smart key or central door lock/unlock switch.

⚠ CAUTION

Liftgate lift

Make certain that you close the liftgate before driving your vehicle. Possible damage may occur to the liftgate lift cylinders and attached hardware if the liftgate is not closed prior to driving.



ODEEV068013NR

- Only the liftgate is unlocked if the liftgate unlock button on the smart key is pressed for approximately 1 second.

- If unlocked, the liftgate can be opened by pressing the handle and pulling it up.
- Once the liftgate is opened and then closed, the liftgate locks automatically. (All doors must be locked.)

* NOTICE

In cold and wet climates, door lock and door mechanisms may not work properly due to freezing conditions.

⚠ WARNING

The liftgate swings upward. Make sure no objects or people are near the rear of the vehicle when opening the liftgate.

Closing the liftgate

Lower and push down the liftgate firmly. Make sure that the liftgate is securely latched.



ODEEV068014NR

Make sure your hands, feet and other parts of your body are safely out of the way before closing the liftgate.

⚠ WARNING

Rear cargo area

Occupants should never ride in the rear cargo area where no restraints are available. Occupants should always be properly restrained.

Opening the liftgate in emergency

Your vehicle is equipped with the emergency liftgate safety release lever located on the bottom of the liftgate. When someone is inadvertently locked in the luggage compartment.



ODEEV068015NR

The liftgate can be opened by doing as follows:

1. Input the mechanical key into the hole.
2. Push the mechanical key to the right.
3. Push up the liftgate.

⚠ WARNING

- No one should be allowed to occupy the cargo area of the vehicle at any time. The cargo area is a very dangerous location in the event of a crash.
- Use the release lever for emergencies only. Use with extreme caution, especially while the vehicle is in motion.

⚠ WARNING

Make sure there are no people or objects around the liftgate before opening or closing the liftgate. Wait until the liftgate is open fully and stopped before loading or unloading cargo from the vehicle.

⚠ WARNING

Do not grasp the part supporting the liftgate (gas lifter), as this may cause serious injury.



ODEEV068016NR

Windows

The doors of this vehicle are equipped with power windows that can be operated by a switch.



ODEEV068017NR

1. Driver's door power window switch
2. Front passenger's door power window switch
3. Rear door (left) power window switch
4. Rear door (right) power window switch
5. Window opening and closing
6. Automatic power window up/down (if equipped)
7. Power window lock switch

* if equipped

* NOTICE

In cold and wet climates, power windows may not work properly due to freezing conditions.

The POWER button must be in the ON position for power windows to operate.

Each door has a power window switch that controls the door's window. The driver has a power window lock button which can block the operation of rear passenger windows. The power windows can be operated for approximately 30 seconds after the POWER button is turned off. However, if the front doors are opened, the power windows cannot be operated even within the 30 seconds period.

The driver's door has a master power window switch that controls all the windows in the vehicle.

If the window cannot be closed because it is blocked by objects, remove the objects and close the window.

* NOTICE

While driving with the rear windows down or with the sunroof (if equipped) in an open (or partially open position), your vehicle may demonstrate a wind buffeting or pulsation noise. This noise is a normal occurrence and can be reduced or eliminated by taking the following actions. If the noise occurs with one or both of the rear windows down, partially lower both front windows approximately one inch. If you experience the noise with the sunroof open, slightly reduce the size of the sunroof opening.

⚠ CAUTION

Do not install any accessories in the vehicle that extend into the open window area. Such objects will impact the proper function of the Automatic reversal "jam protection" feature.

Window opening and closing

Type A

To open or close a window, press down or pull up the front portion of the corresponding switch to the first detent position (5).



0DEEV068018NR

Type B – Auto up/down window (if equipped)



ODEEV068019NR

Pressing or pulling up the power window switch momentarily to the second detent position (6) completely lowers or raises the window even when the switch is released. To stop the window at the desired position while the window is in operation, pull up or press down and release the switch.

If the power window does not operate normally, the automatic power window system must be reset as follows:

1. Turn the POWER button to the ON position.
2. Close the window and continue pulling up the power window switch for at least 1 second after the window is completely closed.

Automatic reversal (For Type B)

If the upward movement of the window is blocked by an object or part of the body, the window will detect the resistance and will stop upward movement. The window will then lower approximately 11.8 in (30 cm) to allow the object to be cleared.



ODEEV068020NR

If the window detects the resistance while the power window switch is pulled up continuously, the window will stop upward movement then lower approximately 1 in (2.5 cm).

If the power window switch is pulled up continuously again within 5 seconds after the window is lowered by the automatic window reversal feature, the automatic window reversal will not operate.

* NOTICE

The automatic reverse feature for the window is only active when the "auto up" feature is used by fully pulling up the switch. The automatic reverse feature will not operate if the window is raised using the half-way position on the power window switch.

⚠ WARNING

Always check for obstructions before raising any window to avoid injuries or vehicle damage. If an object less than 0.16 in (4 mm) in diameter is caught between the window glass and the upper window channel, the automatic reverse window may not detect the resistance and will not stop and reverse direction.

⚠ WARNING

The automatic reverse feature doesn't activate while resetting power window system. Make sure body parts or other objects are safely out of the way before closing the windows to avoid injuries.

⚠ WARNING

Do not install any accessories in the vehicle that extend into the open window area. Such objects could prevent the automatic reverse feature from functioning.

Power window lock button

The driver can disable the power window switches on the rear passengers' doors by pressing the power window lock switch to the lock position (pressed).



ODEEV068021NR

When the power window lock switch is pressed:

- The driver's master control can operate the front passenger's power window and the rear passengers' power windows.
- The front passenger's control can operate the front passenger's power window.
- The rear passengers' control cannot operate the rear passengers' power window.

⚠ CAUTION**Opening/closing Window**

To prevent possible damage to the power window system, do not open or close two windows or more at the same time. This will also ensure the longevity of the fuse.

Always double check to make sure all arms, hands, head and other obstructions are safely out of the way before closing a window.

If the window cannot be close because it is blocked by objects, remove the objects and close the window.

⚠ WARNING**Power windows**

- Do not allow children to play with the power windows. Keep the power window lock button (on the driver's door) in the LOCK (pressed) position.
- Do not extend a face or arms outside the window opening while the vehicle is in motion. Doing so could result in significant bodily injury.

Hood

The hood serves as a cover for the motor room. Open the hood when you need to maintain the motor room or when you need to look at the motor compartment.

Opening the hood

1. Pull the release lever to unlatch the hood. The hood should pop open slightly.



ODEEV068022NR

⚠ WARNING

Open the hood after turning off the POWER button on a flat surface, turn the shifter dial to the P (Park) position and setting the parking brake.

2. Go to the front of the vehicle, raise the hood slightly, push the secondary latch (1) up side and lift the hood (2).



3. Pull out the stay rod.
4. Hold the hood opened with the stay rod (1).



⚠ WARNING

Stay Rod

- To prevent injuries from being burned by hot metal, grab the stay rod in the area wrapped in rubber.
- Ensure that the stay rod is completely inserted into the hole on the hood whenever you inspect the motor compartment. This will prevent the hood from falling and possibly injuring you.

Hood open warning

A warning message will appear on the LCD display when hood is open.



The warning chime will operate when the vehicle is being driven above 2 mph (3 km/h) with the hood open.

Closing the hood

1. Before closing the hood, check the following:
 - All filler caps in the motor compartment must be correctly installed.
 - Gloves, rags or any other combustible material must be removed from the motor compartment.
2. Lower the hood halfway and push down to securely lock in place.
 - Then double check to be sure the hood is secure.
 - If the hood can be lifted with a slight force, open the hood again and close it more firmly.

⚠ CAUTION**Hood obstruction**

Before closing the hood, ensure that all obstructions are removed from the hood opening. Closing the hood with an obstruction present in the hood opening may result in severe personal injury or property damage.

⚠ WARNING**Fire risk**

Do not leave gloves, rags or any other combustible material in the motor compartment. Doing so may cause a heat-induced fire.

⚠ WARNING**Unsecured hood**

Always double check to be sure that the hood is firmly latched before driving away. If it is not latched, the hood could fly open while the vehicle is being driven, causing a total loss of visibility, which might result in an accident.

Sunroof (if equipped)

If your vehicle is equipped with a sunroof, you can slide or tilt your sunroof with the sunroof control switch located on the overhead console.



0DEEV068068NR

The sunroof can only be opened, closed, or tilted when the POWER button is in the ON position.

The sunroof can be operated for approximately 30 seconds after the POWER button is turned to the ACC or OFF position.

However, if the front door is opened, the sunroof cannot be operated even within the 30 seconds period.

*** NOTICE**

In cold and wet climates, the sunroof may not work properly due to freezing conditions.

After the vehicle is washed or in a rainstorm, be sure to wipe off any water that is on the sunroof before operating it.

The sunroof cannot slide when it is in the tilt position nor can it be tilted while in an open or slide position.

⚠ CAUTION

To prevent damage to the sunroof, periodically remove any dirt that may accumulate on the guide rail.

⚠ CAUTION**Sunroof control lever**

Do not continue to press the sunroof control lever after the sunroof is fully opened, closed, or tilted. Damage to the motor or system components could occur.

⚠ WARNING**Sunroof operation**

When closing the sunroof, make sure there are no body parts in the movement range of the sliding roof. Parts of the body could become trapped or crushed.

⚠ WARNING

In order to prevent accidental operation of the sunroof, especially by a child, do not let a child operate the sunroof.

⚠ WARNING

Never adjust the sunroof or sunshade while driving. This could result in loss of control and an accident that may cause death, serious injury, or property damage.

⚠ CAUTION

Make sure the sunroof is fully closed when leaving your vehicle. If the sunroof is opened, rain or snow may leak through the sunroof and wet the interior as well as increase the risk of theft.

⚠ WARNING**Roof cargo**

Do not operate the sun roof while using the roof rack to transport cargo. This may cause the cargo to come loose and distract the driver.

⚠ WARNING

In order to prevent accidental operation of the sunroof, especially by a child, do not let a child operate the sunroof.

⚠ CAUTION

Do not sit on the top of the vehicle. It may cause vehicle damage.

Sliding the sunroof

ODEEV068026NR

- To open or close the sunroof (manual slide feature), push the sunroof control switch backward or forward to the first detent position.
- To open the sunroof (autoslide feature), push the sunroof control switch backward to the second detent position. The sunroof will slide to the recommended open position about 3 in (7 cm) before the maximum slide open position).

To stop the sunroof sliding at any point, push the sunroof control switch momentarily.

- To open the sunroof to the maximum slide open position, press the switch towards the rear of the vehicle once again and hold it until the sunroof slide all the way open.

*** NOTICE**

To reduce wind noise while driving, we recommend you to drive at the recommended position (about 2.7 in (7 cm) before the maximum slide open position).

- To close the sunroof (autoslide feature), move the sunroof control switch forward to the second detent position. The sunroof will close all the way. To stop the sunroof sliding at any point, pull or push the sunroof control switch momentarily.

Automatic reversal

If an object or part of the body is detected while the sunroof is closing automatically, it will reverse direction, and then stop.

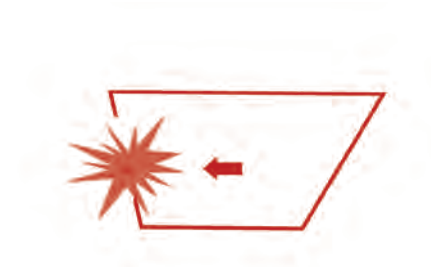

ODEEV068027NR

The auto reverse function will not work if a small obstacle is caught in the sunroof. You should always make sure that all passengers and objects are away from the sunroof before closing it.

Tilting the sunroof



ODEEV068028NR

- To tilt open the sunroof, push the sunroof control switch upward until the sunroof moves to the desired position.
- To close the sunroof, push the sunroof switch forward until the sunroof moves to the desired position.

⚠ WARNING

Sunroof

Do not extend the face, neck, arms or body outside through the sunroof opening while driving or operating the sunroof.

⚠ CAUTION

Sunroof motor damage

If you try to open the sunroof when the temperature is below freezing or when the sunroof is covered with snow or ice, the glass or the motor could be damaged.

⚠ WARNING

Sunroof Operation

When closing the sunroof, make sure there are no body parts in the movement range of the sliding roof. Parts of the body could become trapped or crushed.

Sunshade

The sunshade will be opened with the glass panel automatically when the glass panel is opened. You will have to close it manually if you want it closed.

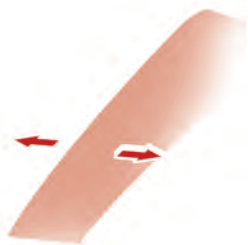

0DEEV068029NR

⚠ CAUTION

The sunroof is made to slide together with the sunshade. Do not pull or push the sunshade by hand as such action may damage the sunshade or cause it to malfunction.

Resetting the sunroof

Reset the sunroof when:

- The battery is discharged or disconnected or the sunroof fuse has been replaced or disconnected.
 - The sunroof control switch is not operating correctly.
1. Place the POWER button to the ON position or start the vehicle (indicator ON). It is recommended to reset the sunroof while the vehicle is in the ready (mode).
 2. Close the sunroof completely if opened.
 3. Release the sunroof control switch.
 4. Move the sunroof control lever forward in the direction of close until the sunroof moves tilt up. Then, release the switch.
 5. Move the sunroof control switch forward in the direction of close, until the sunroof operates as follows again:
Go to the Tilt down → Slide Open
→ Slide Close.

* NOTICE

Do not release the switch until the operation is completed.

If you release the switch during operation, try again from step 2.

6. Release the sunroof control switch after all operation has completed. (The sunroof system has been reset.)

* For more detailed information, contact an authorized Kia dealer.

* NOTICE

If the sunroof is not reset when the vehicle battery is disconnected or discharged, or related fuse is blown, the sunroof may operate improperly.

Sunroof open warning

If the driver turns off the POWER button when the sunroof is not fully closed, the warning chime will sound for approximately 6 seconds and a message will appear on the LCD window.



Close the sunroof securely when leaving your vehicle.

Steering wheel

The steering wheel of this vehicle is equipped with electronic power steering.

Electronic power steering

Power steering uses an electric motor to assist you in steering the vehicle.

If the vehicle is off or if the power steering system becomes inoperative, the vehicle may still be steered, but it will require increased steering effort.

Electronic power steering is controlled by the power steering control unit which senses the steering wheel torque and vehicle speed to command the motor.

The steering effort becomes heavier as the vehicle's speed increases and becomes lighter as the vehicle's speed decreases for better control of the steering wheel.

Should you notice any change in the effort required to steer during normal vehicle operation, have the power steering checked by an authorized Kia dealer.

*** NOTICE**

The following symptoms may occur during normal vehicle operation:

- The EPS warning light does not illuminate.
- The steering gets heavy immediately after turning the POWER button is ON position. This happens as the system performs the EPS system diagnostics. When the diagnostics are completed, the steering wheel will return to its normal condition.
- A click noise may be heard from the EPS relay after turning the POWER button is ON or OFF position.
- A motor noise may be heard when the vehicle is at a stop or at a low driving speed.
- If the Electronic Power Steering System does not operate normally, the warning light will illuminate on the instrument cluster. The steering wheel may become difficult to control or operate abnormally. Take your vehicle to an authorized Kia dealer and have the vehicle checked as soon as possible.
- When the charging system warning light comes on due to the low voltage (when the alternator or battery does not operate normally or malfunctions), the steering wheel may require increased steering effort.

If the Electronic Power Steering System does not operate normally, the warning light will illuminate on the instrument cluster. The steering wheel may become difficult to control or operate abnormally. In this case, have the system inspected by an authorized Kia dealer.

When you operate the steering wheel in low temperature, the steering effort may be high and abnormal noise could occur. If temperature rises, the noise will disappear. This is a normal condition.

When the vehicle is stationary, and the steering wheel is turned all the way to the left or right continuously, the steering wheel becomes harder to turn. The power assist is limited to protect the motor from overheating.

As time passes, the steering wheel will return to its normal condition.

Tilt & telescopic steering wheel

A tilt and telescopic steering wheel allows you to adjust the steering wheel before you drive.

You can also raise it to give your legs more room when you exit and enter the vehicle.

The steering wheel should be positioned so that it is comfortable for you to drive, while permitting you to see the instrument panel warning lights and gauges.

⚠ WARNING**Steering wheel adjustment**

Never adjust the angle and height of the steering wheel while driving. You may lose steering control.

Adjusting steering wheel angle and height

ODEEV068031NR

1. To change the steering wheel angle, pull down the lock release lever (1).
2. Adjust the steering wheel to the desired angle (2) and height (3).
3. Pull up the lock-release lever (4) to lock the steering wheel in place.
4. Be sure to adjust the steering wheel to the desired position before driving.

*** NOTICE**

After adjustment, sometimes the lock-release lever may not lock the steering wheel.

It is not a malfunction. This occurs when two gears engage. In this case, adjust the steering wheel again and then lock the steering wheel.

Heated steering wheel (if equipped)

With the POWER button in the ON position, pressing the heated steering wheel button warms the steering wheel. The indicator on the button will illuminate.



ODEEV068032NR

To turn the heated steering wheel off, press the button once again. The indicator on the button will turn off.

* NOTICE

The heated steering wheel will turn off automatically approximately 30 minutes after the heated steering wheel is turned on.

⚠ CAUTION

- Do not install any type of grip cover for the steering wheel, it may impair the function of the heated steering wheel system.
- When cleaning the heated steering wheel, do not use an organic solvent such as paint thinner, benzene, alcohol and gasoline. Doing so may damage the surface of the steering wheel.
- If the surface of the steering wheel is damaged by a sharp object, damage to the heated steering wheel components could occur.

⚠ WARNING

If the steering wheel becomes too warm, turn the system off. The heated steering wheel may cause burns even at low temperatures, especially if used for long periods of time.

Horn

To sound the horn, press the area indicated by the horn symbol on your steering wheel (see illustration).



0DEEV068033NR

The horn will operate only when this area is pressed. Check the horn regularly to be sure it operates properly.

* NOTICE

To sound the horn, press the area indicated by the horn symbol on your steering wheel (see illustration). The horn will operate only when this area is pressed.

Mirrors

This vehicle is equipped with a rear-view mirrors inside and outside to provide views of objects behind the vehicle.

Inside rearview mirror

Adjust the rearview mirror so that the center view through the rear window is seen. Make this adjustment before you start driving.

Do not place objects in the rear seat or cargo area which would interfere with your vision through the rear window.

⚠ WARNING

Mirror adjustment

Do not adjust the rearview mirror while the vehicle is moving. This could result in loss of control.

⚠ WARNING

Do not modify the inside mirror and don't install a wide mirror. It could result in injury during an accident or deployment of the air bag.

⚠ CAUTION

Cleaning mirror

When cleaning the mirror, use a paper towel or similar material dampened with glass cleaner. Do not spray glass cleaner directly on the mirror. It may cause the liquid cleaner to enter the mirror housing.

Day/night rearview mirror with Telematics function (if equipped)

For day and night function:



* (1): Day, (2): Night

Make this adjustment before you start driving and while the day/night lever (1) is in the day position. Pull the day/night lever (2) toward you to reduce the glare from the headlights of the vehicles behind you during night driving. Remember that you lose some rearview clarity in the night position.

For Telematics button function:



ODEEV068035NR

Telematics buttons are also located on the mirror.

1. Virtual Assist button
2. UVO (Voice local search) button
3. Roadside assist button

Electric chromic mirror (ECM) with HomeLink® system

Your vehicle may be equipped with a Gentex Automatic-Dimming Mirror with an Integrated HomeLink® Wireless Control System.

During nighttime driving, this feature will automatically detect and reduce rearview mirror glare. The HomeLink® Universal Transceiver allows you to activate your garage door(s), electric gate, home lighting, etc.



ODEEV068236NR

1. Virtual Assist button
2. UVO (Voice local search) button
3. Roadside assist button
4. HomeLink Channel 1
5. HomeLink Channel 2
6. HomeLink Channel 3
7. User interface indicator
8. HomeLink operation indicator
9. Orange blinking: Closing
Solid Green: Closed
10. Orange blinking: Opening
Solid Green: Open

Automatic-Dimming Night Vision Safety™ (NVS®) Mirror

The NVS® Mirror in your vehicle is the most advanced way to reduce annoying glare in the rearview mirror during any driving situation. For more information regarding NVS® mirrors and other applications, please refer to the Gentex website: www.gentex.com

* Night Vision Safety™ is a registered trademark of Gentex Corporation.

▲ CAUTION

The NVS[®] Mirror automatically reduces glare during driving conditions based upon light levels monitored in front of the vehicle and from the rear of the vehicle. These light sensors are visible through openings in the front and rear of the mirror case. Any object that obstructs either light sensor will degrade the automatic dimming control feature.

Automatic-dimming function

Your mirror will automatically dim upon detecting glare from the vehicles traveling behind you.

*** NOTICE**

The mirror defaults to the ON position each time the vehicle is started.

Integrated HomeLink[®] Wireless Control System

The HomeLink[®] Wireless Control System provides a convenient way to replace up to three hand-held radiofrequency (RF) transmitters with a single built-in device. This innovative feature will learn the radio frequency codes of most current transmitters to operate devices such as gate operators, garage door openers, entry door locks, security systems, even home lighting. Both standard and rolling code-equipped transmitters can be programmed by following the outlined procedures. Additional HomeLink[®] information can be found at: www.homelink.com or by calling 1-800-355-3515.

* HomeLink[®] is a registered trademark of Gentex Corporation.

Retain the original transmitter of the RF device you are programming for use in other vehicles as well as for future HomeLink[®] programming. It is also suggested that upon the sale of the vehicle, the programmed HomeLink[®] buttons be erased for security purposes.

Programming HomeLink®

* NOTICE

- When programming a garage door opener, it is advised to park the vehicle outside of the garage.
- It is recommended that a new battery be placed in the hand-held transmitter of the device being programmed to HomeLink® for quicker training and accurate transaxle of the radio-frequency signal.
- Some vehicles may require the POWER button to be ACC (or "Accessories") position for programming and/or operation of HomeLink®.
- In the event that there are still programming difficulties or questions after following the programming steps listed below, contact HomeLink® at: www.homelink.com or 1-800-355-3515.

Standard programming

To train most devices, follow these instructions:

1. Press and release (1), (2) or (3) button.



- If the indicator (4) is turned ON in Orange, go to Step 3 since it is a new programming.
 - If the indicator (4) is continuously turned ON or flashes in Green rapidly several times, go to Step 2 since it is a programmed button.
2. Press and hold the button you wish to program about 15–25 seconds until the LED flashes in Orange for several times.
 3. Hold the Garage Door Opener Original Transmitter (OT) near the HomeLink Mirror.
 4. Press the Original Transmitter (OT) button until the indicator (4) is turned continuously ON or flashes in Green for approximately 10 seconds and it indicates the programming is completed.

ODEEV068040NR

*** NOTICE**

- Some garage door openers require to press the programmed button on the mirror up to three times right after the programming is just completed to operate the garage door.
- The indicator (4) is turned ON in Orange and flashes for about 60seconds, during the programming mode and if a programming is not succeeded within the 60 seconds, the programming mode will be abort.

HomeLink® should now activate your rolling code equipped device.

Gate operator & Canadian programming

During programming, your handheld-transmitter may automatically stop transmitting. Continue to press the Integrated HomeLink® Wireless Control System button while you press and re-press ("cycle") your handheld transmitter every two seconds until the frequency signal has been learned.

The indicator light will flash slowly and then rapidly after several seconds upon successful training.

Operating HomeLink®

ODEEV068039NR

- Press and release one of the HomeLink buttons (1, 2 or 3) that programmed.
The HomeLink indicator (4) will operate as below:
 - Indicates Green and is continuously ON (Fixed Code Garage Door Opener)
 - Flashes in Green rapidly (Rolling Code Garage Door Opener)

Erasing HomeLink® buttons



ODEEV068041NR

1. Press and hold the button (1) and (3) simultaneously.
The indicator (4) is turned continuously ON in orange for about 10 seconds.
Then the indicator (4) color changes to Green and flashes rapidly.
2. Release the buttons once the green indicator flashes.
Now HomeLink button (1), (2) and (4) memories are all cleared.

NVS® is a registered trademark and Z-Nav™ is a trademark of the Gentex Corporation, Zeeland, Michigan.

HomeLink® is a registered trademark owned by Johnson Controls, Incorporated, Milwaukee, Wisconsin.

FCC ID: NZLZTVHL3

IC: 4112A-ZTVHL3

This device complies with Part 15 of the FCC Rules.

Operation is subject to the following three conditions:

1. This device may not cause harmful interference, and
2. This device must accept any interference received, including interference that may cause undesired operation.
3. The transceiver has been tested and complies with FCC and Industry Canada rules. Changes or modifications not expressly approved by the party responsible for compliance could void the user's authority to operate the device.

Two Way Communication Programming

1. Complete the HomeLink "Programming" first.
2. Before the first 10 times HomeLink button is pressed after the programming, the following steps MUST occur to program two way communication. (only for some older garage doors)
3. Press and release the programmed HomeLink button to activate the garage door.



ODEEV068042NR

4. Once the garage door is stopped, press and release the "Lean" or "Smart" button on the Garage door opener within 1 minute from the time of pressing the programmed HomeLink button on mirror.

If the both indicator (4) and (6) are flashing rapidly for about 5 seconds, the two way synchronization is completed.



ODEEV068043NR

*** NOTICE**

Some recent garage door opener provides automatic two way communication synchronization while just programing OT (Original Transmitter).

Operating Two Way Communication

- Press and release (1), (2) or (3) button.



ODEEV068042NR

The indicator (4) and (6) operates as below:



ODEEV068044NR

- If the indicator (4) flashes in Orange, it indicates that the garage door is "closing".

- If the indicator (4) is ON continuously in Green, it indicates that the garage door is "closed".
- If the indicator (6) flashes in Orange, it indicates that the garage door is "Opening".
- If the indicator (6) is ON continuously in Green, it indicates that the garage door is "Opened".
- If the indicator (4) or (6) does not turn to Green, it indicates that the last status of garage door was not received properly (HomeLink mirror tries to receive the last status of garage door for seconds.)

Recalling Garage Door Status

Homelink mirror with two way compatible provides a way to view the last stored message from the garage door opener.

In order to recall the last known status of the last activated device, press the buttons "1 and 2" OR "2 and 3" simultaneously.

- If the indicator (4) is ON continuously in Green, it indicates that the last activated device was "closed" properly.
- If the indicator (6) is ON continuously in Green, it indicates that the last activated device was "open" properly.

*** NOTICE**

Two way communication range distance between "vehicle" and "garage door opener" is 3,937 in (100 m).

The range may be reduced or increased a little due to obstacle conditions around the garage door opener, such as houses or trees.

Outside rearview mirror

Your vehicle is equipped with both left-hand and right-hand outside rearview mirrors.

Be sure to adjust the mirror angles before driving.

The mirrors can be adjusted remotely with the remote switch. The mirror heads can be folded back to prevent damage during an automatic car wash or when passing through a narrow street.

⚠ CAUTION

Rearview mirrors

Do not scrape ice off the mirror face; this may damage the surface of the glass. If ice should restrict the movement of the mirror, do not force the mirror for adjustment. To remove ice, use a de-icer spray, a sponge or soft cloth with very warm water.

If the mirror is jammed with ice, do not adjust the mirror by force. Use an approved spray de-icer (not radiator antifreeze) to release the frozen mechanism or move the vehicle to a warm place and allow the ice to melt.

⚠ WARNING

Mirror adjustment

Do not adjust or fold the outside rearview mirrors while the vehicle is moving. This could result in loss of control.

Adjusting the outside rearview mirrors



ODEEV068046NR

Adjusting the rearview mirrors:

1. Press either the L (Front left side) or R (Front right side) button (1) to select the rearview mirror you would like to adjust.
2. Use the mirror adjustment control (2) to position the selected mirror up, down, left or right.

3. After adjustment, put the button into neutral (center) position to prevent inadvertent adjustment.

⚠ CAUTION

- The mirrors stop moving when they reach the maximum adjusting angles, but the motor continues to operate while the switch is pressed. Do not press the switch longer than necessary, the motor may be damaged.
- Do not attempt to adjust the outside rearview mirror by hand. Doing so may damage the parts.

Folding the outside rearview mirror

Manual type

1. To fold the outside rearview mirror, grasp the housing of the mirror and then fold it toward the rear of the vehicle.



ODEEV068047NR

Electric type

1. The outside rearview mirror can be folded or unfolded by pressing the switch when the POWER button is in the ON position as below.



ODEEV068048NR

- **Left:** The mirror will unfold.
- **Right:** The mirror will fold.
- **Center (AUTO)**

The mirror will fold or unfold automatically as follows:

- The mirror will fold or unfold when the door is locked or unlocked by the smart key.
- The mirror will fold or unfold when the door is locked or unlocked by the button on the outside door handle.
- The mirror will unfold when you approach the vehicle (all doors closed and locked) with a smart key in possession. (if equipped)

⚠ CAUTION

The electric type outside rearview mirror operates even though the POWER button is in OFF position. However, to prevent unnecessary battery discharge, do not adjust the mirrors longer than necessary while the POWER button is ON.

Do not fold an electric type outside rearview mirror by hand as this could cause motor failure.

Charging door

To charge the vehicle, open the charging door.

Opening the charging door



ODEEV018045NR

1. Be sure to turn off the power after switching off the various power switches and turning the shifter dial to parking (P).
2. Apply the parking brake on while the brake pedal is depressed.
3. Open the charging door by touching the icon of the charging door. The charging door will not open if the vehicle door is locked.

* NOTICE

If you cannot open the charging door due to freezing weather, tap lightly or remove any ice near the charging door. Do not try to forcibly open the charging door.

Closing the charging door



ODEEV018050NR

1. Close the charging inlet cover securely.
2. Close the charging door securely.

Instrument cluster

The instrument cluster displays various information about the vehicle's condition.



ODEEV068050NR

* The actual cluster and contents of the LCD display in the vehicle may differ from the illustration.

1. Power/Charge gauge
2. Speedometer
3. Warning and indicator lights
4. LCD display (including Trip computer)
5. Battery SOC (State of Charge) gauge
6. Distance to empty

Instrument cluster control

The brightness of the instrument panel illumination is changed by pressing the illumination control button ("+" or "-") when POWER button is ON, or the taillights are turned on.



ODEEV068051NR

- If you hold the illumination control button ("+" or "-"), the brightness will be changed continuously.



ODEEV068052NR

- If the brightness reaches to the maximum or minimum level, an alarm will sound.

LCD display control

The LCD display modes can be changed by using the control buttons on the steering wheel.

Type A



ODEEV068053NR

Type B



ODEEV068054NR

1. : MODE button for change the LCD MODES
2. : MOVE scroll switch for select the items
3. OK: SET/RESET button for set the items or reset the items

* For the LCD modes, refer to "LCD display" on page 5-53.

Gauges

The gauges display various information such as the speed of the vehicle, the amount of charge of the battery, and so on.

Speedometer



The speedometer indicates the speed of the vehicle and is calibrated in miles per hour (mph) and/or kilometers per hour (km/h).

Power/Charge gauge

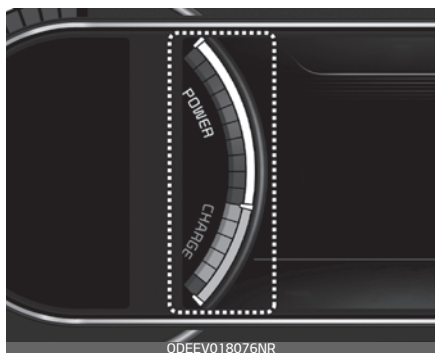

The Power/Charge gauge shows the energy consumption rate of the vehicle and the charge/discharge status of the regenerative brakes.

- **POWER:** It shows the energy consumption rate of the vehicle when driving uphill or accelerating. The more electric energy is used, the higher the gauge level.
- **CHARGE:** It shows the charging status of the battery when it is being charged by the regenerative brakes (decelerating or driving on a downhill road). The more electric energy is charged, the lower the gauge level.

State of Charge (SOC) gauge for high voltage battery

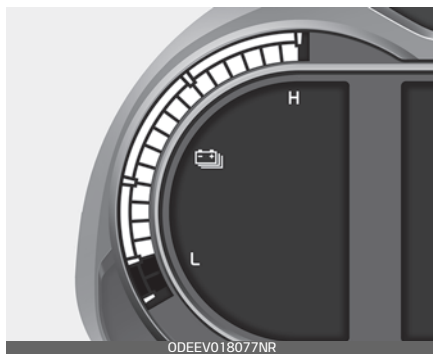

The SOC gauge shows the charging status of the high voltage battery. "L (Low)" position on the indicator indicates that there is not enough energy in the high voltage battery. "H (High)" position indicates that the driving battery is fully charged. When driving on highways or

motorways, make sure to check in advance if the driving battery is charged enough.

When there are 2 gauge bars (near the "L (Low)" area) on the SOC gauge, the warning lamp turns ON alert you of the battery level.



ODEEV018078NR

When the warning lamp turns ON the vehicle can drive an additional 12~18 miles (20~30 km) depending on the driving speed, heater/air conditioner, weather, driving style, an other factors. Charging is required.

WARNING

When there are 1-2 gauge bars left for the high voltage battery, the vehicle speed is limited and then eventually the vehicle will turn OFF. Charge the vehicle immediately.

Distance to empty



ODEEV018075NR

- The distance to empty is the estimated distance the vehicle can be driven with the remaining level of the high voltage battery.
- The distance to empty is displayed differently according to the selected drive mode in the Drive Mode Integrated Control System.

* For more details, refer to "Drive mode integrated control system" on page 6-76.

Additional Distance to Empty from Regenerative Braking



ODEEV068060NR

The additional distance to empty which is converted from the energy regenerated by the regenerative braking is displayed if the ECO/ECO+ mode is selected by pressing the Drive Mode button. The display is initialized to 0 if the regenerative braking stops because of acceleration, etc.

Odometer

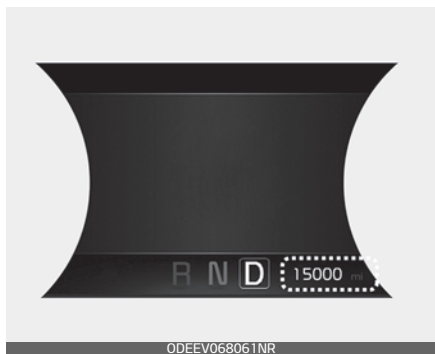

The odometer indicates the total distance that the vehicle has been driven and should be used to determine when periodic maintenance should be performed.

- Odometer range: 0 ~ 999,999 miles or 1,599,999 kilometers.

Outside Temperature Gauge

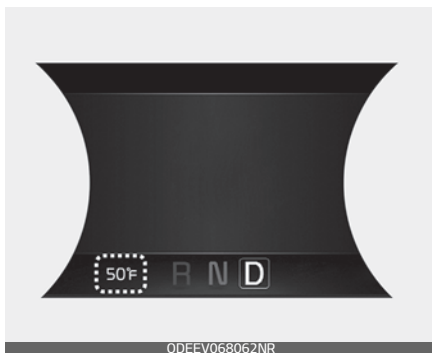

This gauge indicates the current outside air temperatures by 1 °F (1 °C).

- Temperature range: -40~140 °F (-40~60 °C)

The outside temperature on the display may not change immediately like a general thermometer to prevent the driver from being distracted.

To change the temperature unit (from °F to °C or from °C to °F)

The temperature unit can be changed by using the "User Settings" mode of the LCD display.

* For more details, refer to "LCD display" on page 5-53.

Reduction gear

This indicator displays which position is selected.

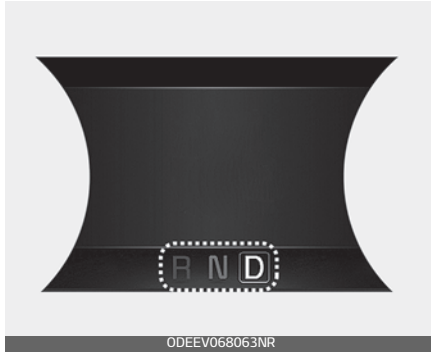

- Park: P
- Reverse: R
- Neutral: N
- Drive: D

Shift indicator pop-up (if equipped)

The pop-up indicates the current gear position displayed in the cluster for about 2 seconds when shifting into other positions (P/R/N/D).

Type A

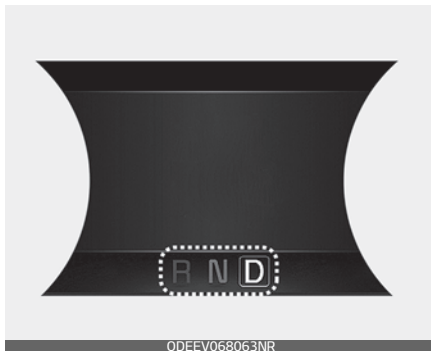

Type B

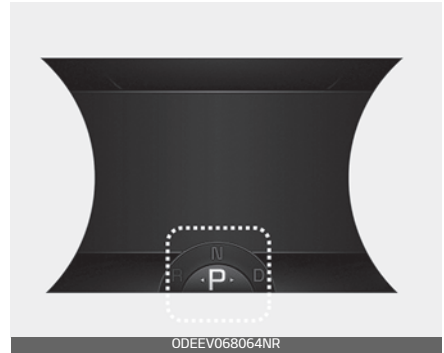

The shift indicator pop-up function can be activated or deactivated from the User Settings mode in the cluster LCD display.

Regenerative braking level indicator

While using the regenerative brakes, you may select the regenerative braking level from 0 to 3 by pulling the paddle shifter.



* For more details, refer to "Regenerative braking system" on page 6-16.

Utility mode (if equipped)

The high voltage battery is used instead of the 12 V auxiliary battery for operating the convenient features of the vehicle.



When driving is not necessary such as while camping or when stopping the vehicle for a long time, it is possible to use the electrical devices (audio, lights, etc.) for long hours.

The driver can activate the Utility Mode function when the following conditions are satisfied.

- The vehicle is in the ready (🚗) mode and the gear is shifted to P (Park).
- The EPB (Electronic Parking Brake) is applied.
- User Settings → Convenience → Utility Mode is selected in the cluster.

Utility mode activation

When the system is activated:

- The indicator will turn off and the indicator will illuminate on the cluster.
- All electric devices are usable but the vehicle cannot be driven.
- The EPB can be cancelled by pressing the EBP switch.
- Gear cannot be shifted out of P (Park). If a shift attempt is made, a message "Shifting conditions not met" will be displayed on the cluster.

Utility mode deactivation



The Utility Mode can be deactivated by pressing the POWER button to the OFF position. The function cannot be deactivated from the User Settings mode.

LCD display

The LCD display shows trip computer and other information.

LCD Display Control

The LCD display modes can be changed by using the control buttons.

1. : MODE button for changing modes
2. : MOVE switch for changing items
3. OK: SELECT/RESET button for setting or resetting the selected item

Type A



ODEEV068053NR







Type B



ODEEV068054NR

LCD Display Modes

The LCD display provides 5 modes. You can switch modes by pressing the Mode button.

 Mode					
 Trip Computer  Turn By Turn (TBT)  Assist  User Settings  Master warning					
 Up/Down	Consumption Info	Route Guidance	Lane Keeping Assist	Driver Assistance	The Master Warning mode displays warning messages related to the vehicle when one or more systems is not operating normally.
	Accumulated Info	Destination Info	Driver Attention Warning	Door	
	Drive Info		Tire Pressure	Lights	
	Driving Style			Sound	
	Energy Flow			Convenience	
				Service Interval	
	Other features				
	Language				
	Reset				

The information provided may differ depending on which functions are applicable to your vehicle.

Trip computer mode



The trip computer mode displays information related to vehicle driving parameters including fuel economy, tripmeter information and vehicle speed.

* For more details, refer to "Trip information (Trip computer)" on page 5-62.

Turn By Turn (TBT) mode



This mode displays the state of the navigation.

Assist mode



This mode displays the state of:

- Lane Safety system
- Driver Attention Warning (DAW)
- Tire pressure

* For more details, refer to each system information in "Driving your vehicle" on page 6-5.

Tire pressure status

* For more details, refer to "Tire Pressure Monitoring System (TPMS)" on page 7-9.

Master warning mode

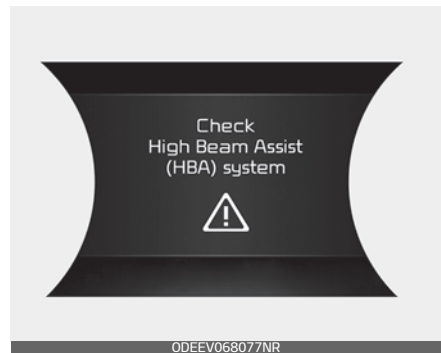

This warning light informs the driver the following situations.

- LED headlamp malfunction (if equipped)
- Forward Collision-Avoidance Assist system malfunction (if equipped)
- Forward Collision-Avoidance Assist radar blocked (if equipped)
- Blind-Spot Collision Warning system malfunction (if equipped)
- Blind-Spot Collision Warning radar blocked (if equipped)
- Smart Cruise Control with Stop & Go malfunction (if equipped)
- Smart Cruise Control with Stop & Go radar blocked (if equipped)
- Lamp malfunction
- High Beam Assist malfunction (if equipped)

At this time, a Master Warning icon (⚠️) will appear beside the User Settings icon (⚙️), on the LCD display.

If the warning situation is resolved, the master warning light will be turned off and the Master Warning icon will disappear.

User settings mode

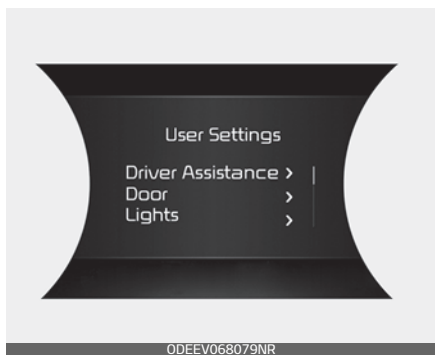

In this mode, you can change the settings of the instrument cluster, doors, lamps, etc.

1. Driver Assistance
2. Door
3. Lights
4. Sound
5. Convenience
6. Service Interval
7. Other features
8. Reset

The information provided may differ depending on which functions are applicable to your vehicle.

Shift to P to edit settings

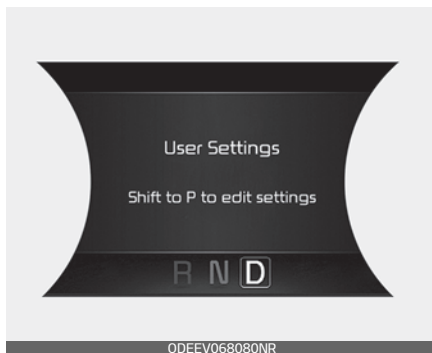

This warning message appears if you try to adjust the User Settings while driving.

For your safety, change the User Settings after parking the vehicle, applying the parking brake and shifting to P (Park).

1. Driver Assistance

	Explanation
Lane Safety	The driver is able to choose one of two functions <ul style="list-style-type: none"> • Lane Keeping Assist • Lane Departure Warning * For more details, refer to "Lane Keeping Assist (LKA) System (if equipped)" on page 6-106.
Driver Attention Warning	<ul style="list-style-type: none"> • High sensitivity / Normal sensitivity / Off To adjust the sensitivity of the Driver Attention Warning. * For more details, refer to "Driver Attention Warning (DAW) (if equipped)" on page 6-96.
SCC Reaction	<ul style="list-style-type: none"> • Slow / Normal / Fast To adjust the sensitivity of the Smart Cruise Control system. * For more details, refer to "Smart Cruise Control with Stop & Go System (if equipped)" on page 6-59.
Forward Collision-Avoidance Assist	To activate or deactivate the Forward Collision-Avoidance Assist system. * For more details, refer to "Forward Collision-Avoidance Assist (FCA) (Smart Cruise Control System Equipped) (if equipped)" on page 6-45.
Forward Collision Warning	To adjust the initial warning alert time for Forward Collision-Avoidance Assist system. <ul style="list-style-type: none"> • Early / Normal / Late * For more details, refer to "Forward Collision-Avoidance Assist (FCA) (Smart Cruise Control System Equipped) (if equipped)" on page 6-45.
Blind-Spot Collision Warning Sound	To activate or deactivate the Blind-Spot Collision Warning sound. * For more details, refer to "Blind-Spot Collision Warning (if equipped)" on page 6-78.
Rear Cross-Traffic Collision Warning	To activate or deactivate the Rear Cross-Traffic Collision Warning function * For more details, refer to "Blind-Spot Collision Warning (if equipped)" on page 6-78.

* The information provided may differ depending on which functions are applicable to your vehicle.

2. Door

	Explanation
Automatically Lock	<ul style="list-style-type: none"> • Enable on speed: All doors will be automatically locked when the vehicle speed exceeds 9.3 mph (15 km/h). • Enable on shift: All doors will be automatically locked if the vehicle is shifted from the P (Park) position to the R (Reverse), N (Neutral), or D (Drive) position.
Automatically Unlock	<ul style="list-style-type: none"> • Disable: The auto door unlock operation will be canceled. • Vehicle off: All doors will be automatically unlocked when the POWER button is set to the OFF position. • On shift to P: All doors will be automatically unlocked if the gear is shifted to the P (Park) position.
2-press Unlock	<ul style="list-style-type: none"> • Off: The 2-press unlock function will be deactivated. Therefore, all doors will unlock if the door unlock button is pressed. • On: Only the driver's door will unlock if the door unlock button is pressed. When the door unlock button is pressed again within 4 seconds, the remaining doors will unlock.

* The information provided may differ depending on which functions are applicable to your vehicle.

3. Lights

	Explanation
One Touch Turn Signal	<ul style="list-style-type: none"> • Off: The one touch turn signal function will be deactivated. • 3, 5, 7 Flashes: The turn signal indicator will blink 3, 5, or 7 times when the turn signal lever is moved slightly. <p>* For more details, refer to "Lighting" on page 5-91.</p>
Ambient Light Brightness (if equipped)	To select the brightness of the ambient light. (Level 1~4)
Ambient Light Color (if equipped)	To select the color of the ambient light. (White / Grey/ Blue/ Green/ Bronze/ Red)

* The information provided may differ depending on which functions are applicable to your vehicle.

4. Sound

	Explanation
Parking Distance Warning Volume (if equipped)	<ul style="list-style-type: none"> Level 1 / Level 2 / Level 3 To adjust the Parking Distance Warning system volume.

* The information provided may differ depending on which functions are applicable to your vehicle.

5. Convenience (if equipped)

	Explanation
Seat easy access (if equipped)	<ul style="list-style-type: none"> Off: The seat easy access function will be deactivated. Normal/Extended <ul style="list-style-type: none"> When you turn off the vehicle, the driver's seat will automatically move rearward short (Normal) or long (Extended) for you to enter or exit the vehicle more comfortably. If you change the POWER button from OFF position to ACC or ON position, the driver's seat will return to the original position. * For more details, refer to "Driver position memory system for power seat (if equipped)" on page 4-10.
Utility Mode	To activate the utility mode. When activated, electric devices in the vehicle is operated using the high voltage battery. * For more details, refer to "Utility Mode (if equipped)" on page 1-54.
Welcome Mirror/Light (if equipped)	If this item is checked, the welcome mirror/light function will be activated.
Wireless charging system (if equipped)	If this item is checked, the wireless charging system function will be activated.
Wiper/Lights Display (if equipped)	If this item is checked, the wiper/lights display will be activated.
Auto rear wiper (in R) (if equipped)	If this item is checked, the Auto rear wiper function will be activated.

	Explanation
Smart Regeneration	If this item is checked the Smart Regeneration function will be activated. When activated, the regeneration level is adjusted automatically according to the current driving situation. * For more details, refer to "Smart regeneration system (If equipped with smart cruise control)" on page 6-19.
Icy Road Warning	If this item is checked, the Icy Road Warning function will be activated.

* The information provided may differ depending on which functions are applicable to your vehicle.

6. Service Interval

	Explanation
Enable Service Interval	If this item is checked, the Service Interval function will be activated.
Adjust Interval	If the service interval menu is activated, you may adjust the time and distance.
Reset	To reset the service interval function.

If the service interval is activated and the time and distance is adjusted, messages are displayed in the following situations each time the vehicle is turned on.

- Service in: Displayed to inform the driver the remaining mileage and days to service.
- Service required: Displayed when the mileage and days to service has been reached or passed.

If any of the following conditions occur, the mileage and number of days to service may be incorrect.

- The battery cable is disconnected.
- The fuse switch is turned off.
- The battery is discharged.

7. Other

	Explanation
Aux. Battery Saver+	To activate or deactivate the Aux. Battery Saver+ function. When activated, the high voltage battery is used to keep the 12 V battery charged. * For more information, refer to "12 V Aux. Battery Saver+" on page 1-52.
Energy Consumption Reset	<ul style="list-style-type: none"> • Off: The average fuel economy will not reset automatically whenever recharging. • After Ignition: The average fuel economy will reset automatically whenever it has passed 4 hours after turning OFF the vehicle. • After Recharging: The average fuel economy will reset automatically when recharging. * For more details, refer to "Trip information (Trip computer)" on page 5-62.
Temperature Unit	<ul style="list-style-type: none"> • °F / °C To select the temperature unit.
Tire Pressure Unit	<ul style="list-style-type: none"> • psi / kPa / bar To select the tire pressure unit.

* The information provided may differ depending on which functions are applicable to your vehicle.

8. Reset

	Explanation
Reset	You can reset the menus in the User Settings mode. All menus in the User Settings mode are reset to factory settings, except language and service interval.

LCD displays

LCD displays show the following information to drivers.



- Trip information
- LCD modes
- Warning messages

Trip information (Trip computer)

The trip computer is a microcomputer-controlled driver information system that displays information related to driving.

* NOTICE

Some driving information stored in the trip computer resets if the battery is disconnected.

Trip Modes

To change the trip mode, scroll the toggle the switch (\wedge / \vee) on the steering wheel.

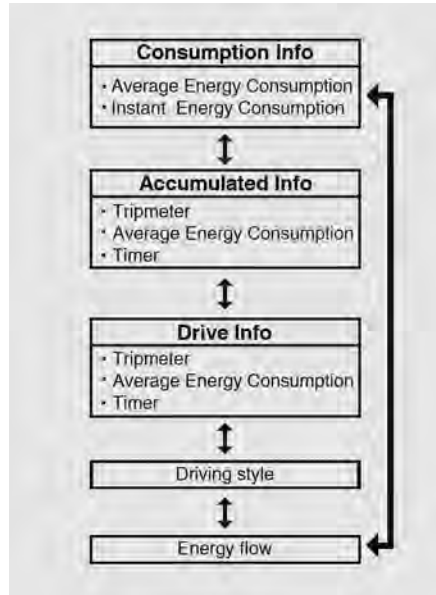

Consumption info display



Average Energy Consumption (1)

- The average energy consumption is calculated by the total driving distance and the high voltage battery consumption since the last average energy consumption reset.

- The average energy consumption can be reset both manually and automatically.

Manual reset

To clear the average energy consumption manually, press the OK button on the steering wheel for more than 1 second when the average energy consumption is displayed.

Automatic reset

To automatically reset the average energy consumption select either menu from the 'Energy Consumption Reset' in the User Settings mode on the LCD display.

- After ignition: The average energy consumption will reset automatically whenever it has passed 4 hours after turning OFF the vehicle.
- After recharging: The average energy consumption will reset automatically when driving speed exceeds 1 mph (1 km/h), after recharging more than 10%.

* NOTICE

The vehicle must be driven for a minimum of 0.19 miles (300 meters) since the last ignition key cycle before the average energy consumption will be recalculated.

Instant Energy Consumption (2)

- The instantaneous energy consumption is displayed according to the bar graph in the LCD display while driving.

Accumulated Info display



This display shows the accumulated trip distance (1), the average energy consumption (2), and the total driving time (3).

The information is accumulated starting from the last reset.

To reset the details, press and hold the OK button when viewing the Accumulated driving info. The trip distance, the average energy consumption, and total driving time will reset simultaneously.

The accumulated driving information will continue to be counted while the vehicle is in the ready (🚗) mode (for example, when the vehicle is in traffic or stopped at a stop light).

* NOTICE

The vehicle must be driven for a minimum of 0.19 miles (300 meters) since the last ignition key cycle before the average accumulated driving information is recalculated.

Drive Info display



This display shows the trip distance (1), the average energy consumption (2), and the total driving time (3).

The information is combined for each ignition cycle. However, when the vehicle has been OFF for 4 hours or longer the Drive Info screen will reset.

To reset the details, press and hold the OK button when viewing the Drive Info. The trip distance, the average energy consumption, and total driving time will reset simultaneously.

The driving information will continue to be counted while the vehicle is in the ready (🚗) mode (for example, when the vehicle is in traffic or stopped at a stop light).

* NOTICE

The vehicle must be driven for a minimum of 0.19 miles (300 meters) since the last ignition key cycle before the driving information is recalculated.

Digital speedometer



This digital speedometer display shows the speed of the vehicle.

Energy flow



The electric vehicle system informs the driver its energy flow in various operating modes. While driving, the current energy flow is specified in 3 modes.

Driving style



This display shows whether the driver's driving style is Economical, Normal or Aggressive.

Driving info display

At the end of each driving cycle, the Driving Info message is displayed.



This display shows the trip distance (1), average energy consumption (2), driving time (3), charging time status (4) and climate time status (5).

This information is displayed for a few seconds when you turn off the vehicle, and then goes off automatically. The information is calculated for each time the vehicle is turned on.

* NOTICE

- If sunroof open warning is displayed in the cluster, the Driving Information message may not be displayed.
- To set the charging time and/or climate time, refer to a separately supplied car navigation system manual for detailed information.

Press brake pedal to start vehicle

This warning message is displayed if the POWER button changes to the ACC position twice by pressing the button repeatedly without depressing the brake pedal.

You can start the vehicle by depressing the brake pedal.

Key not in vehicle

This warning message is displayed if the smart key is not in the vehicle when you press the POWER button.

When attempting to start the vehicle, always have the smart key with you.

Key not detected

This warning message is displayed if the smart key is not detected when you press the POWER button.

Press POWER button again

This message is displayed if you were unable to start the vehicle when the POWER button was pressed.

If this occurs, attempt to start the vehicle by pressing the POWER button again.

If the warning message appears each time you press the POWER button, have your vehicle inspected by an authorized Kia dealer.

Press POWER button with key

This warning message is displayed if you press the POWER button while the warning message "Key not detected" is displayed.

Check BRAKE SWITCH fuse

This warning message is displayed if the brake switch fuse is disconnected.

You need to replace the fuse with a new one before starting the vehicle.

If that is not possible, you can start the vehicle by pressing the POWER button for 10 seconds in the ACC position.

Shift to P to start vehicle

This warning message is displayed if you try to start the vehicle without shifting to the P (Park) position.

Shift to P

This warning message is displayed if you try to turn off the vehicle with the gear in the N (Neutral) position.

At this time, the POWER button changes to the ACC position (If you press the POWER button once more, it will turn to the ON position).

Low Key Battery

This warning message is displayed if the battery of the smart key is discharged while changing the POWER button to the OFF position.

Battery discharging due to external electrical devices

This message is displayed if the battery voltage is weak due to any nonfactory electrical accessories (ex. dashboard camera). Be careful that the battery is not discharged.

If the warning message appears after removing the non-factory electrical accessories, have your vehicle inspected by an authorized Kia dealer.

Door, Hood, Liftgate open warning display



This warning is displayed if any door or the hood or the liftgate is left open. The warning will indicate which door is open in the display.

⚠ CAUTION

Before driving the vehicle, you should confirm that the door/hood/liftgate is fully closed. Also, check there is no door/hood/liftgate open warning light or message displayed on the instrument cluster.

Sunroof open warning display (if equipped)



This warning is displayed if you turn off the vehicle when the sunroof is open.

Close the sunroof securely before leaving your vehicle.

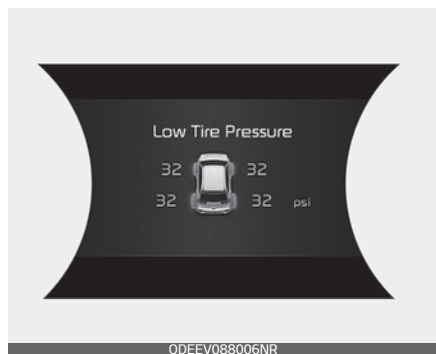
Low Pressure warning display

This warning message is displayed if the tire pressure is low. The corresponding tire on the vehicle will be illuminated.

* For more details, refer to "Tire Pressure Monitoring System (TPMS)" on page 7-9.

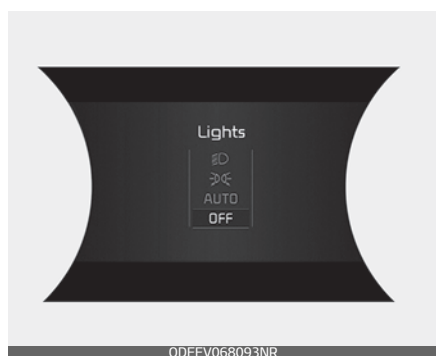
Lights mode

This indicator displays which exterior light is selected using the lighting control.

You can activate or deactivate Wiper/Lights Display function from the User Settings mode in the cluster LCD display.

Wiper mode

This indicator displays which wiper speed is selected using the wiper control.

You can activate or deactivate Wiper/Lights Display function from the User Settings mode in the cluster LCD display.

Low washer fluid

This warning message is displayed if the washer fluid level in the reservoir is nearly empty.

Have the washer fluid reservoir refilled.

Check headlight (if equipped)

This warning message is displayed if the headlights are not operating

properly. A headlight bulb may need to be replaced.

Make sure to replace the burned out bulb with a new one of the same wattage rating.

Check turn signal (if equipped)

This warning message is displayed if the turn signal lamps are not operating properly. A lamp may need to be replaced.

Make sure to replace the burned out bulb with a new one of the same wattage rating.

Check brake light (if equipped)

This warning message is displayed if the stop lamps are not operating properly. A lamp may need to be replaced.

Make sure to replace the burned out bulb with a new one of the same wattage rating.

Check High Beam Assist (HBA) system (if equipped)

This warning message is displayed if there is a problem with the High Beam Assist (HBA) system. Have your vehicle inspected by an authorized Kia dealer.

* For more details, refer to "High Beam Assist (if equipped)" on page 5-95.

Check headlight LED (if equipped)

This warning message is displayed if there is a problem with the LED headlight. Have your vehicle inspected by an authorized Kia dealer.

Check Forward Collision Avoidance Assist system (if equipped)

This warning message is displayed if there is a problem with the Forward Collision-Avoidance Assist (FCA) system. Have your vehicle inspected by an authorized Kia dealer.

* For more details, refer to "Forward Collision-Avoidance Assist (FCA) (Smart Cruise Control System Equipped) (if equipped)" on page 6-45.

Check Blind-Spot Collision Warning (BCW) system (if equipped)

This warning message is displayed if there is a problem with the Blind-Spot Collision Warning system. Have your vehicle inspected by an authorized Kia dealer.

* For more details, refer to "Blind-Spot Collision Warning (if equipped)" on page 6-78 and "Rear Cross-Traffic Collision Warning (RCCW) (if equipped)" on page 6-88.

Check Smart Cruise Control System (if equipped)

This warning message is displayed if there is a problem with the Smart Cruise Control system. Have your vehicle inspected by an authorized Kia dealer.

* For more details, refer to "Smart Cruise Control with Stop & Go System (if equipped)" on page 6-59.

Check Driver Attention Warning (DAW) system (if equipped)

This warning message is displayed if there is a problem with the Driver Attention Warning (DAW). Have your vehicle inspected by an authorized Kia dealer.

* For more details, refer to "Driver Attention Warning (DAW) (if equipped)" on page 6-96.

Check Lane Keeping Assist (LKA) system (if equipped)

This warning message is displayed if there is a problem with the Lane Keeping Assist (LKA) system. Have your vehicle inspected by an authorized Kia dealer.

* For more details, refer to "Lane Keeping Assist (LKA) System (if equipped)" on page 6-106.

Shift to P to charge

This message is displayed if you connect the charging cable without the gear in the P (Park) position.

Shift to P (Park) before connecting the charging cable.

Remaining Time

This message is displayed to notify the remaining time to charge the battery to the selected target battery charge level.

Unplug vehicle to start

This message is displayed when you start the vehicle without unplugging the charging cable. Unplug the charging cable, and then turn on the vehicle.

Charging Door Open

This message is displayed when the vehicle is driven with the charging door opened. Close the charging door and then start driving.

Aux. Battery Saver+ used while parked

This message is displayed when the Aux. Battery Saver+ function has been completed.

* For more information, refer to "12 V Aux. Battery Saver+" on page 1-52.

Charging Stopped. Check the cable connection

This warning message is displayed when charging is stopped because the charging connector is not correctly connected to the charging inlet.

If this occurs, separate the charging connector and re-connect it and check whether there is any problem (external damage, foreign substances, etc.) with the charging connector and charging inlet.

If the same problem occurs when charging the vehicle with a replaced charging cable or genuine Kia portable charger, we recommend that you have your vehicle inspected by an authorized Kia dealer.

Low Battery



When the high voltage battery level reaches below 8%, this warning message is displayed.

The warning light on the instrument cluster () will turn ON simultaneously.

Charge the high voltage battery immediately.

Charge immediately. Power limited

When the high voltage battery level reaches below 3%, this warning message is displayed.

The warning light on the instrument cluster () and the power down warning light () will turn on simultaneously.

The vehicle's power will be reduced to minimize the energy consumption of the high voltage battery. Charge the battery immediately.

Low outside temperature may limit power output. Charge EV battery / Low EV battery temperature. Power limited

Both warning messages are displayed to protect electric vehicle system when outside temperature is low. If the high voltage battery charging level is low and parked outside in low temperature for a long time, vehicle power could be limited.

Charging the battery before driving helps increase power.

*** NOTICE**

If this warning message is still displayed even after the ambient temperature has increased, have your vehicle inspected by an authorized Kia dealer.

EV Battery Overheated! Stop vehicle

This warning message is displayed to protect battery and electric vehicle system when the high voltage battery temperature is too high.

Turn off the POWER button and stop the vehicle so that the battery temperature decreases.

Power limited

This warning message is displayed when the vehicle's power is limited due to any of the following reasons:

- When the high voltage battery is below a certain level, or voltage is decreasing.
- When the temperature of the motor or high voltage battery is too high or too low.
- When there is a problem with the cooling system or a failure that may interrupt normal driving.

*** NOTICE**

When this warning message is displayed, do not accelerate or start the vehicle suddenly.

Charge the battery immediately when the high voltage battery level is not enough.

Stop vehicle and check power supply

This warning message is displayed when a failure occurs in the power supply system.

If this occurs, park the vehicle in a safe location and tow your vehicle to the nearest authorized Kia dealer and have your vehicle inspected by an authorized Kia dealer.

Check Virtual Engine Sound System

This message is displayed when there is a problem with the Virtual Engine Sound System (VESS).

If this occurs, have your vehicle inspected by an authorized Kia dealer.

Check electric vehicle system

This warning message is displayed when there is a problem with the electric vehicle control system.

Refrain from driving when the warning message is displayed.

If this occurs, have your vehicle inspected by an authorized Kia dealer.

Warning and indicator lights

The warning light and indicator light indicate a situation where the driver should be careful and whether the various functions are activated.

Warning lights

The warning light indicates situations that require the driver to pay attention.

* NOTICE

Warning lights

Make sure that all warning lights are OFF after starting the vehicle. If any light is still ON, this indicates a situation that needs attention.

Service Warning Light

This warning light illuminates:

- When the POWER button is in the ON position.
 - It illuminates for approximately 3 seconds and then goes off.
- When there is a problem with related parts of the electric vehicle control system, such as sensors, etc.

When the warning light illuminates while driving, or does not go OFF after starting the vehicle, have your vehicle inspected by an authorized Kia dealer.

Air bag Warning Light

This warning light illuminates:

- Once you set the POWER button to the ON position.
 - It illuminates for approximately 6 seconds and then goes off.
- When there is a malfunction with the SRS.

In this case, have the vehicle inspected by an authorized Kia dealer.

Seat Belt Warning Light

This warning light informs the driver that the seat belt is not fastened.

* For more details, refer to "Seat belts" on page 4-19.

Parking Brake & Brake Fluid Warning Light

This warning light illuminates:

- Once you set the POWER button to the ON position.
 - It illuminates for approximately 3 seconds
 - It remains on if the parking brake is applied.
- When the parking brake is applied.
- When the brake fluid level in the reservoir is low.
 - If the warning light illuminates with the parking brake released, it indicates the brake fluid level in reservoir is low.

If the brake fluid level in the reservoir is low:

1. Drive carefully to the nearest safe location and stop your vehicle.
2. With the vehicle stopped, check the brake fluid level immediately and add fluid as required (For more details, refer to "Brake fluid" on page 8-17). Then check all brake components for fluid leaks. If any leak on the brake system is still found, the warning light remains on, or the brakes do not operate properly, do not drive the vehicle.

In this case, have your vehicle towed to an authorized Kia dealer and inspected.

Dual-diagonal braking system

Your vehicle is equipped with dual-diagonal braking systems. This means you still have braking on two wheels even if one of the dual systems should fail.

With only one of the dual systems working, more than normal pedal travel and greater pedal pressure are required to stop the vehicle. Also, the vehicle will not stop in as short a distance with only a portion of the brake system working.

WARNING

Parking Brake & Brake Fluid Warning Light

Driving the vehicle with a warning light ON is dangerous. If the Parking Brake & Brake Fluid Warning Light illuminates with the parking brake released, it indicates that the brake fluid level is low.

In this case, have your vehicle inspected by an authorized Kia dealer.

Anti-lock Brake System (ABS) Warning Light

This warning light illuminates:

- When the POWER button is in the ON position.
 - It illuminates for approximately 3 seconds and then goes off.
- When there is a malfunction with the ABS (The normal braking system will still be operational without the assistance of the anti-lock brake system).

In this case, have your vehicle inspected by an authorized Kia dealer.

Electronic Brake force Distribution (EBD) System Warning Light



These two warning lights illuminate at the same time while driving:

- When the ABS and regular brake system may not work normally. In this case, have your vehicle inspected by an authorized Kia dealer.

WARNING

Electronic Brake force Distribution (EBD) System Warning Light

When both ABS and Parking Brake & Brake Fluid Warning Lights are on, the brake system will not work normally and you may experience an unexpected and dangerous situation during sudden braking.

In this case, avoid high speed driving and abrupt braking.

Have your vehicle inspected by an authorized Kia dealer as soon as possible.

Regenerative Brake Warning Light



This warning light illuminates:

When the regenerative brake does not operate and the brake does not perform well. This causes the Brake Warning light (red) and Regenera-

tive Brake Warning Light (yellow) to illuminate simultaneously.

In this case, drive safely and have your vehicle inspected by an authorized Kia dealer as soon as possible. The operation of the brake pedal may be more difficult than normal and the braking distance can increase.

Electronic Power Steering (EPS) Warning Light



This warning light illuminates:

- When the POWER button is in the ON position.
 - It remains on until the vehicle is started.
 - When there is a malfunction with the EPS.
- When there is a malfunction with the EPS. In this case, have your vehicle inspected by an authorized Kia dealer.

Charging System Warning Light



This warning light illuminates:

- When the 12-volt battery level is low or a failure occurs on the charging system such as LDC.
- If the warning light turns on while driving, move the vehicle to a safe location, turn off and turn on the vehicle again, and check if the warning light turns off. If the

warning light remains on, have your vehicle inspected by an authorized Kia dealer.

- Even if the warning light turns off, have the vehicle inspected by an authorized Kia dealer. If you drive the vehicle while the warning light is on, vehicle speed may be limited and the 12-volt battery may be discharged.
- * LDC: Low voltage DC-DC Converter.

High Voltage Battery Low Level Warning Light

This warning light illuminates:

- When the high voltage battery level is low. When the warning light turns ON, charge the battery immediately.

Power Down Warning

This warning light illuminates:

When the power is limited for the safety of the electric vehicle. Power can be limited for the following reasons.

- The high voltage battery level is below a certain level or voltage is decreasing.
- The temperature of the motor or high voltage battery is too high or too low.
- There is a problem with the cooling system, or a failure that may interrupt normal driving.

*** NOTICE**

Do not accelerate or start the vehicle suddenly when the power down warning light is ON.

Charge the battery immediately when the high voltage battery level is not enough.

Low Tire Pressure Warning Light

 (if equipped)

This warning light illuminates:

- When the POWER button is in the ON position.
 - It illuminates for approximately 3 seconds and then goes off.
 - When one or more of your tires are significantly under inflated.
- * For more details, refer to "Tire Pressure Monitoring System (TPMS)" on page 7-9.

This warning light remains on after blinking for approximately 60 seconds or repeats blinking on and off at the intervals of approximately 3 seconds:

- When there is a malfunction with the TPMS. In this case, have your vehicle inspected by an authorized Kia dealer.
- * For more details, refer to "Tire Pressure Monitoring System (TPMS)" on page 7-9.

⚠ WARNING**Low tire pressure**

- Significantly low tire pressure makes the vehicle unstable and can contribute to loss of vehicle control and increased braking distances.
- Continued driving on low pressure tires will cause the tires to over-heat and fail.

⚠ WARNING**Safe Stopping**

- The TPMS cannot alert you to severe and sudden tire damage caused by external factors.
- If you notice any vehicle instability, immediately take your foot off the accelerator pedal, apply the brakes gradually with light force, and slowly move to a safe position off the road.

Master Warning Light **This warning light informs the driver the following situations**

- LED headlamp malfunction (if equipped)
- Blind-Spot Collision Warning system malfunction (if equipped)
- Smart Cruise Control with Stop & Go malfunction (if equipped)
- Forward Collision-Avoidance Assist system malfunction (if equipped)

- Blind-Spot Collision Warning radar blocked (if equipped)
- Smart Cruise Control with Stop & Go radar blocked (if equipped)
- Forward Collision-Avoidance Assist radar blocked (if equipped)
- Lamp malfunction
- High Beam Assist malfunction (if equipped)

To identify the details of the warning, look at the LCD display.

Electronic Parking Brake (EPB) Warning Light *EPB (if equipped)***This warning light illuminates:**

- When the POWER button is in the ON position.
 - It illuminates for approximately 3 seconds and then goes off.
- When there is a malfunction with the EPB.

In this case, have your vehicle inspected by an authorized Kia dealer.

*** NOTICE****Electronic Parking Brake (EPB) Warning Light**

The Electronic Parking Brake (EPB) Warning Light may illuminate when the Electronic Stability control (ESC) Indicator Light comes on to indicate that the ESC is not working properly (This does not indicate malfunction of the EPB).

LED Headlamp Warning Light (if equipped)

This warning light illuminates:

- When the POWER button is in the ON position.
 - It illuminates for approximately 3 seconds and then goes off.
- When there is a malfunction with the LED headlamp.

In this case, have your vehicle inspected by an authorized Kia dealer.

This warning light blinks:

- When there is a malfunction with a LED headlamp related part.

In this case, have your vehicle inspected by an authorized Kia dealer.

CAUTION

LED Headlamp Warning Light

Continuous driving with the LED Headlamp Warning Light on or blinking can reduce LED headlamp (low beam) life.

Forward Collision-Avoidance Assist (FCA) System Warning Light (if equipped)

This indicator light illuminates:

- When the POWER button is in the ON position.
 - It illuminates for approximately 3 seconds and then goes off.

- When the FCA system is turned off.
 - When the radar sensor or cover is blocked with dirt or snow. Check the sensor and cover and clean them by using a soft cloth.
 - When there is a malfunction with FCA. If this occurs, have your vehicle inspected by an authorized Kia dealer.
- * For more details, refer to "Forward Collision-Avoidance Assist (FCA) (Smart Cruise Control System Equipped) (if equipped)" on page 6-45.

Indicator lights

The indicator light indicates whether the various functions are activated.

Electronic Stability Control (ESC)

Indicator Light

This indicator light illuminates:

- When the POWER button is in the ON position.
 - It illuminates for approximately 3 seconds and then goes off.
- When there is a malfunction with the ESC system.

In this case, have your vehicle inspected by an authorized Kia dealer.

This indicator light blinks:

While the ESC is operating.

* For more details, refer to "Electronic stability control (ESC)" on page 6-39.

Electronic Stability Control (ESC)**OFF Indicator Light** **This indicator light illuminates:**

- When the POWER button is in the ON position.
 - It illuminates for approximately 3 seconds and then goes off.
- When you deactivate the ESC system by pressing the ESC OFF button.



* For more details, refer to "Electronic stability control (ESC)" on page 6-39.

Charging Cable Connection Indicator

This indicator illuminates in red when the charging cable is connected.

Immobilizer Indicator Light (With Smart Key)  **(if equipped)****This indicator light illuminates for up to 30 seconds:**

- When the vehicle detects the smart key in the vehicle with the POWER button in the ACC or ON position.

- Once the smart key is detected, you can start the vehicle ( indicator ON).
- The indicator light goes off after starting the vehicle ( indicator ON).

This indicator light blinks for a few seconds:

- When the smart key is not in the vehicle.
 - At this time, you cannot start the vehicle.

This indicator light illuminates for 2 seconds and goes off:

- If the smart key is in the vehicle and the POWER button is ON, but the vehicle cannot detect the smart key.
In this case, have your vehicle inspected by an authorized Kia dealer.

This indicator light blinks:

- When the battery of the smart key is weak.
- When there is a malfunction with the immobilizer system.
In this case, have your vehicle inspected by an authorized Kia dealer.

Turn Signal Indicator Light **This indicator light blinks:**

- When you turn the turn signal light on.

If any of the following occurs, there may be a malfunction with the turn signal system.

In this case, have your vehicle inspected by an authorized Kia dealer.

- The indicator light does not blink but illuminates.
- The indicator light blinks more rapidly.
- The indicator light does not illuminate at all.

Low Beam Indicator Light  (if equipped)**This indicator light illuminates:**

- When the headlights are on.

High Beam Indicator Light **This indicator light illuminates:**

- When the headlights are on and in the high beam position.
- When the turn signal lever is pulled into the Flash-to-Pass position.

Light ON Indicator Light **This indicator light illuminates:**

- When the tail lights or headlights are on.

Front Fog Indicator Light **This indicator light illuminates:**

- When the front fog lights are on.

Ready Indicator **This indicator illuminates:**

When the vehicle is ready to be driven.

- ON: Normal driving is possible.
- OFF: Normal driving is not possible, or a problem has occurred.
- Blinking: Emergency driving.

When the ready indicator goes OFF or blinks, there is a problem with the system. In this case, have your vehicle inspected by an authorized Kia dealer.

LKA (Lane Keeping Assistant) System Indicator  (if equipped)

The LKA indicator will illuminate when you turn the lane keeping assistant system on by pressing the LKA button.

If there is a problem with the system, the yellow LKA indicator will illuminate.

* For more details, refer to "Lane Keeping Assist (LKA) System (if equipped)" on page 6-106.

Cruise Indicator Light CRUISE (if equipped)

This indicator light illuminates:

- When the cruise control system is enabled.
- * For more details, refer to "Smart Cruise Control with Stop & Go System (if equipped)" on page 6-59.

SPORT Mode Indicator Light

SPORT (if equipped)

This indicator light illuminates:

- When you select "SPORT" mode as drive mode.
- * For more details, refer to "Drive mode integrated control system" on page 6-76.

ECO Mode Indicator Light **ECO** (if equipped)

This indicator light illuminates:

- When you select "ECO" mode as drive mode.
- * For more details, refer to "Drive mode integrated control system" on page 6-76.

ECO+ Mode Indicator **ECO+**

This indicator light illuminates:

- When you select "ECO+" mode as drive mode.
- * For more details, refer to "Drive mode integrated control system" on page 6-76.

Parking distance warning-reverse (if equipped)

The parking distance warning-reverse assists the driver during backward movement of the vehicle by chiming if any object is sensed within a distance of 49 in (125 cm) behind the vehicle.



The sensing range and objects detectable by the back sensors (1) are limited. Whenever backing-up, pay as much attention to what is behind you as you would in a vehicle without a parking distance warning-reverse.



⚠ WARNING

The parking distance warning–reverse is a supplementary function only. The operation of the parking distance warning reverse can be affected by several factors (including environmental conditions). It is the responsibility of the driver to always check the area behind the vehicle before and while backing up.

Operation of the parking distance warning–reverse

Operating condition

- This system will activate when backing up with the POWER button ON.
If the vehicle is moving at a speed over 3 mph (5 km/h), the system may not be activated correctly.
- The sensing distance while the parking distance warning–reverse is in operation is approximately 49 in (125 cm).
- When more than two objects are sensed at the same time, the closest one will be recognized first.

Types of warning sound	Indicator*
When an object is 49 in to 28 in (125 cm to 71 cm) from the rear bumper: Buzzer beeps intermittently.	
When an object is 28 in to 14 in (70 cm to 36 cm) from the rear bumper: Buzzer beeps more frequently	
When an object is within 14 in (35 cm) of the rear bumper: Buzzer sounds continuously.	

* if equipped

*** NOTICE**

The indicator may differ from the illustration as objects or sensors status.
If the indicator blinks, have the system checked by a professional workshop. Kia recommends to visit an authorized Kia dealer.

Non-operational conditions of parking distance warning–reverse

The parking distance warning–reverse may not operate properly when:

- Moisture is frozen to the sensor. (It will operate normally when the moisture has been cleared.)
- The sensor is covered with foreign matter, such as snow or water, or the sensor cover is blocked. (It will

operate normally when the material is removed or the sensor is no longer blocked.)

- Driving on uneven road surfaces (unpaved roads, gravel, bumps, gradient).
- Objects generating excessive noise (vehicle horns, loud motorcycle engines, or truck air brakes) are within range of the sensor.
- Heavy rain or water spray exists.
- Wireless transmitters or mobile phones are within range of the sensor.
- The sensor is covered with snow.
- Trailer towing

The detecting range may decrease when:

- The sensor is stained with foreign matter such as snow or water. (The sensing range will return to normal when removed.)
- Outside air temperature is extremely hot or cold.

The following objects may not be recognized by the sensor:

- Sharp or slim objects such as ropes, chains or small poles.
- Objects which tend to absorb the sensor frequency such as clothes, spongy material or snow.
- Undetectable objects smaller than 40 in (1 m) in height and narrower than 6 in (14 cm) in diameter.

Parking distance warning-reverse precautions

- The parking distance warning-reverse may not sound consistently depending on the speed and shapes of the objects detected.
- The parking distance warning-reverse may malfunction if the vehicle bumper height or sensor installation has been modified or damaged. Any non-factory installed equipment or accessories may also interfere with the sensor performance.
- The sensor may not recognize objects less than 12 in (30 cm) from the sensor, or it may sense an incorrect distance. Use caution.
- When the sensor is frozen or stained with snow, dirt, or water, the sensor may be inoperative until the stains are removed using a soft cloth.
- Do not push, scratch or strike the sensor. Sensor damage could occur.

*** NOTICE**

This system can only sense objects within the range and location of the sensors; It can not detect objects in other areas where sensors are not installed. Also, small or slim objects, such as poles or objects located between sensors may not be detected by the sensors.

Always visually check behind the vehicle when backing up.

Be sure to inform any drivers of the vehicle that may be unfamiliar with the system regarding the systems capabilities and limitations.

*** NOTICE**

Pay close attention when the vehicle is driven close to objects on the road, particularly pedestrians, and especially children. Be aware that some objects may not be detected by the sensors, due to the object's distance, size or material, all of which can limit the effectiveness of the sensor. Always perform a visual inspection to make sure the vehicle is clear of all obstructions before moving the vehicle in any direction.

Self-diagnosis

If you don't hear an audible warning sound or if the buzzer sounds intermittently when shifting the gear to the R (Reverse) position, this may indicate a malfunction in the parking distance warning-reverse. If this occurs, have the system checked by a professional workshop. Kia recommends to visit an authorized Kia dealer.

⚠ WARNING

Your new vehicle warranty does not cover any accidents or damage to the vehicle or injuries to its occupants due to a parking distance warning-reverse malfunction. Always drive safely and cautiously.

Parking distance warning (if equipped)

The parking distance warning assists the driver during movement of the vehicle by chiming if any object is sensed within the distance of 39 in (100 cm) in front and 47 in (120 cm) behind the vehicle.

Rear



Front



This system is a supplemental system and it is not intended to nor does it replace the need for extreme care and attention of the driver.

The sensing range and objects detectable by the sensors (1) are limited. Whenever moving pay as much attention to what is in front and behind of you as you would in a vehicle without a parking distance warning.

⚠ WARNING

The parking distance warning is a supplemental system only.

The operation of the parking distance warning can be affected by several factors (including environmental conditions).

It is the responsibility of the driver to always check the front and rear views before and while parking.

Operation of the parking distance warning

Operating condition



ODEEV068125NR

- This system activates when the parking distance warning button is pressed with the POWER button ON.
- The indicator of the parking distance warning button turns on automatically and activates the parking distance warning when you shift the gear to the R (Reverse) position. It will turn off automatically when you drive above 12.4 mph (20 km/h).
- The sensing distance while backing up is approximately 47 in (120 cm) when you are driving less than 6.2 mph (10 km/h).
- The sensing distance while moving forward is approximately 39 in (100 cm) when you are driving less than 6.2 mph (10 km/h).
- When more than two objects are sensed at the same time, the







closest one will be recognized first.

- The side sensors are activated when you shift the gear to the R (Reverse) position.
- If the vehicle speed is above 12.4 mph (20 km/h), the system automatically turns off. To activate again, push the button.

* NOTICE

It may not operate if the vehicle's distance from the object is already less than approximately 10 in (25 cm) when the system is activated.

Type of warning indicator and sound

Distance from object		Warning indicator		Warning sound
		When driving forward	When driving rearward	
39~24 inch	Front		-	Buzzer beeps intermittently
47~24 inch	Rear	-		Buzzer beeps intermittently
23~12 inch	Front			Buzzer beeps frequently
	Rear	-		Buzzer beeps frequently
11 inch	Front			Buzzer beeps continuously
	Rear	-		Buzzer beeps continuously

*** NOTICE**

- The actual warning sound and indicator may differ from the illustration depending on the objects or sensor status.
- Do not wash the vehicle's sensor with high pressure water.

*** NOTICE**

- This system can only sense objects within the range and location of the sensors; It cannot detect objects in other areas where sensors are not installed. Also, small or slim objects, such as poles or objects located between sensors may not be detected by the sensors. Always visually check behind the vehicle when backing up.
- Be sure to inform any drivers of the vehicle that may be unfamiliar with the system regarding the systems capabilities and limitations.

Non-operational conditions of parking distance warning

parking distance warning may not operate normally when:

- Moisture is frozen to the sensor. (It will operate normally when moisture melts.)
- Sensor is covered with foreign matter, such as snow or water, or the sensor cover is blocked. (It will operate normally when the material is removed or the sensor is no longer blocked.)
- Sensor is stained with foreign matter such as snow or water. (Sensing range will return to normal when removed.)
- The parking assist button is off.

There is a possibility of parking distance warning malfunction when:

- Driving on uneven road surfaces such as unpaved roads, gravel, bumps, or gradient.
- Objects generating excessive noise such as vehicle horns, loud motorcycle engines, or truck air brakes can interfere with the sensor.
- Heavy rain or water spray.
- Wireless transmitters or mobile phones present near the sensor.
- Sensor is covered with snow.

Detecting range may decrease when:

- Outside air temperature is extremely hot or cold.

- Undetectable objects smaller than 4 in (1 m) and narrower than 5.5 in (14 cm) in diameter.

The following objects may not be recognized by the sensor:

- Sharp or slim objects such as ropes, chains or small poles.
- Objects, which tend to absorb sensor frequency such as clothes, spongy material or snow.

* NOTICE

1. The warning may not sound consistently depending on the speed and shapes of the objects detected.
2. The parking distance warning may malfunction if the vehicle bumper height or sensor installation has been modified. Any non-factory installed equipment or accessories may also interfere with the sensor performance.
3. Sensor may not recognize objects less than 12 in (30 cm) from the sensor, or it may sense an incorrect distance. Use with caution.
4. When the sensor is frozen or stained with snow or water, the sensor may be inoperative until the stains are removed using a soft cloth.
5. Do not push, scratch or strike the sensor with any hard objects that could damage the surface of the sensor. Sensor damage could occur.

* NOTICE

This system can only sense objects within the range and location of the sensors, it cannot detect objects in other areas where sensors are not installed. Also, small or slim objects, or objects located between sensors may not be detected.

Always visually check in front and behind the vehicle when driving. Be sure to inform any drivers in the vehicle that may be unfamiliar with the system regarding the systems capabilities and limitations.

* NOTICE

Pay close attention when the vehicle is driven close to objects on the road, particularly pedestrians, and especially children. Be aware that some objects may not be detected by the sensors, due to the objects distance, size or material, all of which can limit the effectiveness of the sensor. Always perform a visual inspection to make sure the vehicle is clear of all obstructions before moving the vehicle in any direction.

Self-diagnosis

When you shift the gear to the R (Reverse) position and if one or more of the below occurs you may have a malfunction in the parking distance warning system.

- You don't hear an audible warning sound or if the buzzer sounds intermittently.
-  (blinks) is displayed. (if equipped)

If this occurs, we recommend that the system be checked by an authorized Kia dealer.

* NOTICE

Your new vehicle warranty does not cover any accidents or damage to the vehicle or injuries to its occupants related to a parking distance warning. Always drive safely and cautiously.

Rear view monitor

The rearview camera will activate with the POWER button ON and the shift lever in the R (Reverse) position.



- This system is a supplemental system only. It is the responsibility of the driver to always check the inside/outside rearview mirrors and the area behind the vehicle before and while backing up.
- Always keep the camera lens clean. If lens is covered with foreign matter, the camera may not operate normally.

* If your vehicle is equipped with multimedia system, rearview display image will show behind the vehicle through the multimedia monitor while backing-up. Refer to a separately supplied manual for detailed information.

⚠ WARNING

Backing & using camera

Never rely solely on the rear view camera when backing. You must always use methods of viewing the area behind you including looking over both shoulders as well as continuously checking all three rear view mirrors. Due to the difficulty of ensuring that the area behind you remains clear, always back up slowly and stop immediately if you even suspect that a person, and especially a child, might be behind you.

Lighting

This vehicle is equipped with a variety of lights to illuminate the interior and exterior of the vehicle.

Battery saver function

The purpose of this feature is to prevent the battery from being discharged if the lights are left in the ON position. The system automatically shuts off the parking lights 30 seconds after the vehicle is turned off and the driver's door is opened and closed.

With this feature, the parking lights will turn off automatically if the driver parks on the side of the road at night and opens the driver's side door.

If necessary, to keep the parking lights on when the vehicle is turned off, perform the following:

1. Open the driver-side door.
2. Turn the parking lights OFF and ON again using the light switch on the steering column.

Headlight escort function (if equipped)

If you turn the POWER button to the ACC or OFF position with the headlights ON, the headlights remain on for about 5 minutes.

However, if the driver's door is opened and closed, the headlights are turned off after 15 seconds.

The headlights can be turned off by pressing the lock button on the transmitter (or smart key) one more or turning the light switch to the OFF position.

Daytime running light (if equipped)

The Daytime Running Lights (DRL) can make it easier for others to see the front of your vehicle during the day.

DRL can be helpful in many different driving conditions, and it is especially helpful after dawn and before sunset.

The DRL system will turn the dedicated lamp OFF when:

- The headlight switch is on.
- The vehicle is off.
- The front fog light is on.
- Engaging the Parking Brake

Lighting control

The light switch has a Headlight and a Parking light position.



ODEEV068131NR

To operate the lights, turn the knob at the end of the control lever to one of the following positions:

1. OFF position / DRL off position.
2. Auto light position
3. Parking & Tail light
4. Headlight position

Parking Tail light



ODEEV068132NR

When the light switch is in the parking light position, the tail, license and instrument panel lights will turn ON.

Headlight position



ODEEV068133NR

When the light switch is in the headlight position, the head, tail, license lights will turn ON.

* NOTICE

The POWER button must be in the ON position to turn on the headlights.

Auto light (if equipped)



ODEEV068134NR

When the light switch is in the AUTO light position, the taillights and headlights will turn ON or OFF automatically depending on the amount of light outside the vehicle.

When the light switch is positioned at an auto light position, at first, the wiper will turn on and then, after 5 seconds the head lamp will turn on automatically.

If the head lamp has been turned on due to this function of the vehicle, the head lamp will turn off 60 seconds after the wiper has been turned off.

CAUTION

- Never place anything over the sensor (1) located on the instrument panel as this will ensure better auto-light system control.
- Don't clean the sensor using a window cleaner, the cleaner may leave a light film which could interfere with sensor operation.
- If your vehicle has window tint or other types of metallic coating on the front windshield, the Auto light system may not work properly.

Operating high beam



ODEEV068135NR

To turn on the high beam headlamp:

- Push the lever away from you. The lever will return to its original position. The high beam indicator will light when the headlight high beams are switched on. To prevent the battery from being discharged, do not leave the lights on for a prolonged time while the vehicle is off.

WARNING

High beams

Do not use high beam when there are other vehicles in front of or approaching your vehicle. Using high beam could obstruct the other driver's vision.

To flash the headlights:

- Pull the lever towards you.



ODEEV068136NR

It will return to the normal (low beam) position when released. The headlight switch does not need to be on to use this flashing feature.

Operating turn signals and lane change signals



ODEEV068137NR

The POWER button must be on for the turn signals to function.

To turn on the turn signals:

- Move the lever up or down (A). The green arrow indicators on the instrument panel indicate which turn signal is operating. They will self-cancel after a turn is completed. If the indicator continues to flash after a turn, manually return the lever to the OFF position.

To signal a lane change:

- Move the turn signal lever slightly and hold it in position (B). The lever will return to the OFF position when released.

If an indicator stays on and does not flash or if it flashes abnormally, one of the turn signal bulbs may be burned out and will require replacement.

* NOTICE

If an indicator flash is abnormally quick or slow, a bulb may be burned out or have a poor electrical connection in the circuit.

Operating front fog light (if equipped)

Fog lights are designed to provide improved visibility when visibility is poor due to fog, rain or snow, etc.



ODEEV068138NR

The fog lights will turn on when the fog light switch (1) is turned to the on position after the headlight is turned on.

To turn off the fog lights:

- Turn the fog light switch (1) to the OFF position.

High Beam Assist (if equipped)

The High Beam Assist is a system that automatically adjusts the headlamp range (switches between high beam and low beam) depending to the brightness of detected vehicles and certain road conditions.



ODEEV068139NR

Operating High Beam Assist

The High Beam Assist can be operated using the light switch.

1. Place the light switch in the AUTO position.
2. Turn on the high beam by pushing the lever away from you. The High Beam Assist (HBA) indicator will illuminate.

The High Beam Assist will turn on when vehicle speed is above 25 mph (40 km/h).

The details of operation with the light switch while the High Beam Assist is on are below.

- If the light switch is pushed away, the High Beam Assist will turn off and the high beam will be on.
- If the light switch is pulled towards you when the high beam is off, the high beam will be on without canceling the operation of the High Beam Assist. (When you hands off, the lever will move to the middle and the high beam will turn off.)
- If the light switch is pulled towards you when the high beam is on by the High Beam Assist, the low beam will be on and the High Beam Assist will turn off.
- If the light switch is turned to the headlamp position (H) from AUTO position, the High Beam Assist will turn off and the low beam will be on.

When the High Beam Assist is operating, the high beam switches to low beam in the following conditions.

- When the headlamp is detected from the on-coming vehicle.
- When the tail lamp is detected from the front vehicle.
- When headlamp / tail lamp of bicycle/motorcycle is detected.
- When the surrounding is so bright that high beams are not needed.
- When streetlights or other lights are detected.
- When the light switch is not in the AUTO position.
- When the High Beam Assist is off.
- When vehicle speed is below 15 mph (24 km/h).

High Beam Assist warning light and message

When the High Beam Assist System is not working properly, a warning message will come on for a few seconds.

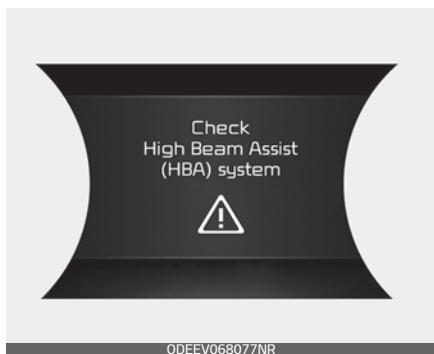

After the message disappears, the master warning light (⚠) will illuminate. Take your vehicle to an authorized Kia dealer and have the system checked.

⚠ CAUTION

The High Beam Assist system may not work properly in the following situations:

- When the light from a vehicle is poor
 - When the light from a vehicle is not detected because of lamp damage, or because it is hidden from sight, etc.
 - When the lamp of a vehicle is covered with dust, snow or water.
 - When a vehicle's headlamps are off but the fog lamps on and etc.
- When external conditions intervene
 - When there is a lamp that has a similar shape as a vehicle's lamps.
 - When the headlamp is not repaired or replaced at an authorized dealer.
 - When headlamp aiming is not properly adjusted.
 - When driving on a narrow curved road, rough road, downhill or uphill.

- When only part of the vehicle in front is visible on a crossroad or curved road.
 - When there is a traffic light, reflecting sign, flashing sign or mirror ahead.
 - When there is a temporary reflector or flash ahead (construction area).
 - When the road conditions are bad such as being wet, iced or covered with snow.
 - When a vehicle suddenly appears from a curve.
 - When the vehicle is tilted from a flat tire or being towed.
 - When front visibility is poor
 - When the lamp of the on-coming or front vehicle is covered with dust, snow or water.
 - When the light from a vehicle is not detected because of exhaust fume, smoke, fog, snow, etc.
 - When the front window is covered with foreign substance.
 - When it is hard to see because of fog, heavy rain or snow and etc.
-
- *
NOTICE
- Do not disassemble a front view camera temporarily for tinted window or attaching any types of coatings and accessories. If you disassemble the camera and assemble it again, take your vehicle to an authorized Kia dealer and have the system checked.
 - When you replace or reinstall the windshield glass, take your vehicle to an authorized Kia dealer and have the system checked.
 - Be careful that water doesn't get into the High Beam Assist unit and do not remove or damage parts of the High Beam Assist system.
 - Do not place objects on the dashboard that reflect light such as mirrors, white paper, etc. The system may not be able to function if sunlight is reflected.
 - At times, the High Beam Assist may not operate due to system limitations. The system is for your convenience only. It is the responsibility of the driver to drive safely and always check the road conditions.
 - When the system does not operate normally, change the lamp position manually between the high beam and low beam.
-

Wipers and washers

The wipers and washers remove foreign substances from the windshield and rear window, helping to maintain visibility.

Front windshield wiper/washer



ODEEV068143NR

Rear windshield wiper/washer



ODEEV068144NR

A: Wiper speed control (front)

- MIST – Single wipe
- OFF – Off
- INT – Intermittent wipe
- LO – Low wiper speed
- HI – High wiper speed

B: Intermittent control wipe time adjustment

C: Wash with brief wipes (front)*

D: Rear wiper/washer control*

- HI – Continuous wipe
- LO – Intermittent wipe*
- OFF – Off

E: Wash with brief wipes (rear)*

* if equipped

Windshield washers

Operates as follows when the POWER button is turned ON.

MIST: For a single wiping cycle, move the lever to this (MIST) position and release it. The wipers will operate continuously if the lever is held in this position.

OFF: Wiper is not in operation

INT: Wiper operates intermittently at the same wiping intervals. Use this mode in light rain or mist. To vary the speed setting, turn the speed control switch.

LO: Normal wiper speed

HI: Fast wiper speed

* NOTICE

If there is heavy accumulation of snow or ice on the windshield, defrost the windshield for about 10 minutes, or until the snow and/or ice is removed before using the windshield wipers to ensure proper operation. If you do not remove the snow and/or ice before using the wiper and washer, it may damage the wiper and washer system.

Operating windshield washer

Use this function when the windshield is dirty.



ODEEV068145NR

1. Move the wiper speed control switch to the OFF position.
2. Pull the lever gently toward you to spray washer fluid on the windshield and to run the wipers 1–3 cycles.
The spray and wiper operation will continue until you release the lever.

If the washer does not work, check the washer fluid level. If the fluid level is not sufficient, you will need to add appropriate non-abrasive windshield washer fluid to the washer reservoir.

The reservoir filler neck is located in the front of the motor compartment on the passenger side.

⚠ CAUTION

Washer pump

To prevent possible damage to the washer pump, do not operate the washer when the fluid reservoir is empty.

⚠ WARNING

Obscured visibility

Do not use the washer in freezing temperatures without first warming the windshield with the defrosters; the washer solution could freeze on the windshield and obscure your vision.

⚠ CAUTION

Wipers & windshields

- To prevent possible damage to the wipers or windshield, do not operate the wipers when the windshield is dry.
- To prevent damage to the wiper blades, do not use gasoline, kerosene, paint thinner, or other solvents on or near them.
- To prevent damage to the wiper arms and other components, do not attempt to move the wipers manually.

Operating rear window wiper and washer switch

The rear window wiper and washer switch is located at the end of the wiper and washer switch lever.

- Turn the switch to the desired position to operate the rear wiper and washer.



ODEEV068146NR

- HI: Continuous wipe
- LO: Intermittent wipe
- OFF: OFF

- Push the lever away from you to spray rear washer fluid and to run the rear wipers 1~3 cycles.



ODEEV068147NR

The spray and wiper operation will continue until you release the lever.

Interior lights

This vehicle is equipped with lights throughout the vehicle to illuminate the interior.

Do not use the interior lights for extended periods when the vehicle is off.

It may cause battery discharge.

⚠ WARNING

Interior Lights

Do not use the interior lights when driving in the dark. Accidents could happen because the view may be obscured by interior lights.

Automatic turn off function (if equipped)

The interior lights automatically turn off approximately 20 minutes after the POWER button is turned off, if the lights are in the ON position.

If your vehicle is equipped with the theft alarm system, the interior lights automatically turn off approximately 5 seconds after the system is armed.

Room lamp

Type A



0DEEV068 148NR

Type B



0DEEV068 149NR

-  : The light stays on at all times.

Map lamp

Type A



ODEEV068150NR

Type B

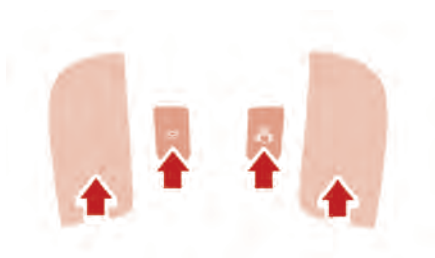



ODEEV068151NR

- Press the lens (1) to turn ON the map lamp.
To turn the map lamp OFF press the lens (1) again.
-  (2): DOOR mode
 - The map lamp and room lamp come on when a door is opened. The lamps go out after approximately 30 seconds.
 - The map lamp and room lamp come on for approximately 30 seconds when doors are unlocked with a transmitter or smart key as long as the doors are not opened.
- The map lamp and room lamp will stay on for approximately 20 minutes if a door is opened with the POWER button in the ACC or LOCK/OFF position.
- The map lamp and room lamp will stay on continuously if the door is opened with the POWER button in the ON position.
- The map lamp and room lamp will go out immediately if the POWER button is changed to the ON position or all doors are locked.
- To turn off the DOOR mode, press the DOOR button (2) once again (not pressed).

* NOTICE

The DOOR mode and ROOM mode cannot be selected at the same time.

Front Room Lamp:

- Type A
 -  (3): Press this switch to turn the front and rear room lamps on.
 -  (4): Press this switch to turn the front and rear room lamps off.
- Type B

 (3): Press this switch to turn the front and rear room lamps on and off.

Liftgate room lamp

The liftgate room lamp comes on when the liftgate is opened.



ODEEV068156NR



* NOTICE

The liftgate lamp comes on as long as the liftgate lid is open. To prevent unnecessary charging system drain, close the liftgate lid securely after using the liftgate.

Vanity mirror lamp (if equipped)



ODEEV068157NR

- Push the switch to turn the light on or off.
 - : The lamp will turn on if this button is pressed.
 - : The lamp will turn off if this button is pressed.

⚠ CAUTION

Vanity mirror lamp

Always have the switch in the off position when the vanity mirror lamp is not in use. If the sun visor is closed without the lamp off, it may discharge the battery or damage the sun visor.

Welcome system (if equipped)

The welcome system is a function that illuminates the surroundings or the interior when the driver approaches or exits the vehicle.

Headlight (Headlamp) escort function

The headlights (and/or taillights) remain on for approximately 5 minutes after the vehicle is turned off. However, if the driver's door is opened and closed, the headlights are turned off after 15 seconds.

The headlights can be turned off by pressing the lock button on the transmitter or smart key twice or turning off the light switch from the headlight or Auto light position.

Interior light

When the interior light switch is in the DOOR position and all doors (and liftgate) are locked and closed, the room lamp will come on for 30 seconds if any of the following occurs.

- With the smart key system
 - When the door unlock button is pressed on the smart key.
 - When the button of the outside door handle is pressed.

At this time, if you press the door lock button, the lamps will turn off immediately.

Pocket lamp (if equipped)

When all doors are locked and closed, the pocket lamp will come on for 15 seconds if any of the below is performed.

- With the smart key system
 - When the door unlock button is pressed on the smart key.
 - When the button of the outside door handle is pressed.

At this time, if you press the door lock button, the lamps will turn off immediately.

Defroster

The vehicle is equipped with a defroster for removing frost or fog from the rear window.

⚠ CAUTION

Conductors

To prevent damage to the conductors bonded to the inside surface of the rear window, never use sharp instruments or window cleaners containing abrasives to clean the window.

If you want to defrost and defog the front windshield, refer to "Windshield defrosting and defogging" on page 5-117.

Operating rear window defroster

The defroster heats the window to remove frost, fog and thin ice from the rear window, while the vehicle is on.

If there is heavy accumulation of snow on the rear window, brush it off before operating the rear defroster.



0DEEV068159NR

To activate the rear window defroster:

- Press the rear window defroster button located in the center facia switch panel.

The indicator on the rear window defroster button illuminates when the defroster is ON.

The rear window defroster automatically turns off after approximately 20 minutes or when the POWER button is turned off.

To turn off the defroster:

- Press the rear window defroster button again.

Outside mirror defroster (if equipped)

If your vehicle is equipped with the outside rearview mirror defrosters, they will operate at the same time you turn on the rear window defroster.

Automatic climate control system

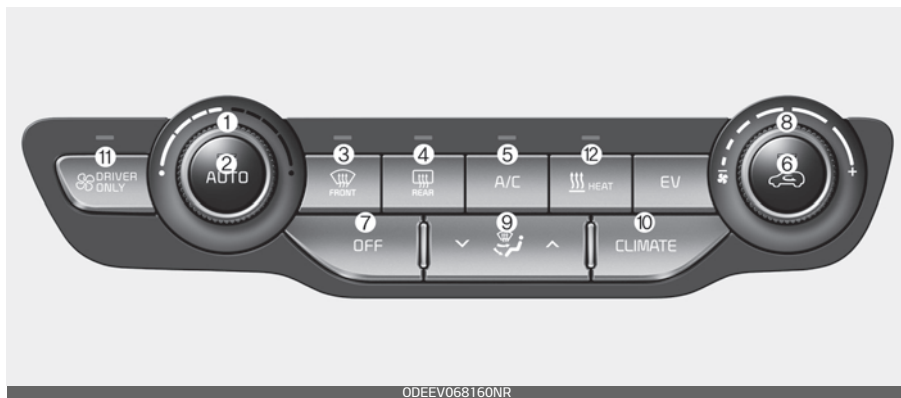

1. Driver's temperature control switch
2. AUTO (automatic control) button
3. Front windshield defroster button
4. Rear window defroster button
5. Air conditioning button
6. Air intake control button
7. OFF button
8. Fan speed control switch
9. Mode selection button
10. Climate button
11. Driver only select button
12. HEAT button

* NOTICE

Operating the blower when the POWER button is in the ON position could cause the battery to discharge. Operate the blower when the vehicle is on.

Heating and air conditioning automatically

1. Press the AUTO button.
The modes, fan speeds, air intake and air-conditioning will be controlled automatically by setting the temperature.



ODEEV068161NR

2. Turn the temperature control switch to the desired temperature.



ODEEV068162NR

- To turn the automatic operation off, select any button or switch of the following:
 - Mode selection button
 - Air conditioning button
 - Front windshield defroster button (Press the button one more

time to deselect the front windshield defroster function. The 'AUTO' sign will illuminate on the information display once again.)

- Air intake control button
 - Fan speed control switch
- The selected function will be controlled manually while other functions operate automatically.

- For your convenience and to improve the effectiveness of the climate control, use the AUTO button and set the temperature to 72 °F (22 °C).

* NOTICE

Do not place anything over the sensor located on the instrument panel to ensure better control of the heating and cooling system.



ODEEV068163NR



Manual heating and air conditioning

The heating and cooling system can be controlled manually by pressing buttons or turning knob(s) other than the AUTO button.



0DEEV068164NR

In this case, the system works sequentially according to the order of buttons or knob(s) selected.

1. Start the vehicle.
2. Set the mode to the desired position.
 - For improving the effectiveness of heating and cooling;
 - Heating: 
 - Cooling: 
3. Set the temperature control to the desired position.
4. Set the air intake control to the outside (fresh) air position.
5. Set the fan speed control to the desired speed.
 - If air conditioning is desired, turn the air conditioning system on.

Press the AUTO button in order to convert to full automatic control of the system.

Mode selection

The mode selection button controls the direction of the air flow through the ventilation system.



ODEEV068167NR

The air flow outlet port is converted as follows:



 **Face-Level (B, D)**

Air flow is directed toward the upper body and face. Additionally, each outlet can be controlled to direct the air discharged from the outlet.

 **Bi-Level (B, C, D, E, F)**

Air flow is directed towards the face and the floor.

 **Floor-Level (A, C, D, E)**

Most of the air flow is directed to the floor, with a small amount of the air being directed to the windshield and side window defrosters.

 **Floor/Defrost-Level (A, C, D, E)**

Most of the air flow is directed to the floor and the windshield with a small amount directed to the side window defrosters.

Defrost-Level (A, D)



ODEEV068173NR

Most of the air flow is directed to the windshield with a small amount of air directed to the side window defrosters.

Instrument panel vents



ODEEV068174NR

The outlet vents can be opened or closed separately using the thumb-wheel. (if equipped)

Also, you can adjust the direction of air delivery from these vents using the vent control lever as shown.

Temperature control



ODEEV068162NR

The temperature will increase to the maximum (82 °F) by turning the knob to the extreme right.

The temperature will decrease to the minimum (62 °F) by turning the knob to the extreme left.

When turning the knob, the temperature will increase or decrease by 1 °F / 0.5 °C. When set to the lowest temperature setting, the air conditioning will operate continuously.

Temperature conversion

You can switch the temperature mode from Centigrade to Fahrenheit as follows:

While pressing the OFF button, press the AUTO button for 3 seconds or more. The display will change from Centigrade to Fahrenheit, or from Fahrenheit to Centigrade. If the battery has been discharged or disconnected, the temperature mode display will reset to Fahrenheit.

Controlling air intake

This is used to select the outside (fresh) air position or recirculated air position.



ODEEV068175NR

To change the air intake control position:

- Push the control button.

Outside (fresh) air position



With the outside (fresh) air position selected, air enters the vehicle from outside and is heated or cooled according to the function selected.

Recirculated air position

With the recirculated air position selected, air from the passenger compartment will be drawn through the heating system and heated or cooled according to the function selected. Prolonged operation of the heater in the recirculated air position (without air conditioning selected) may cause fogging of the windshield and side windows and the air within the passenger compartment may become stale.

In addition, prolonged use of the air conditioning with the recirculated air position selected will result in excessively dry air in the passenger compartment.

Controlling fan speed

The fan speed can be set to the desired speed by operating the fan speed control switch.

To change the fan speed:

- Turn it right for higher speed, or turn it left for lower speed.



ODDEEV068178NR

- To turn the fan speed control off, press the front blower OFF button.

Air conditioning



ODDEEV068179NR

- Press the A/C button to turn the air conditioning system on (indicator light will illuminate).
- Press the button again to turn the air conditioning system off.

⚠ WARNING**Reduced Visibility**

Continuous use of the climate control system in the recirculated air position may allow humidity to increase inside the vehicle which may fog the glass and obscure visibility.

⚠ WARNING**Recirculated Air**

Continued use of the climate control system in the recirculated air position can cause drowsiness or sleepiness, and loss of vehicle control. Set the air intake control to the outside (fresh) air position as much as possible while driving.

⚠ WARNING**Sleeping with A/C on**

Do not sleep in a vehicle with the air conditioning or heating on as this may cause serious harm or death due to a drop in the oxygen level and/or body temperature.

Turning heating on or off

0DEEV068180NR

- Push the HEAT button to turn the heater on (indicator light will illuminate).
- Push the button again to turn the heater off.

The air conditioner and heater uses energy from the battery. If you use the heater or air conditioner for too long, distance to empty can be reduced due to increased power consumption.

Turn off the heater or air conditioner if not necessary.

Turning off the front air climate control



ODEEV068181NR

- Press the front blower OFF button to turn off the front air climate control system. However, you can still operate the mode and air intake buttons as long as the POWER button is in the ON position.

Displaying climate information (if equipped)



ODEEV068182NR

- Press the climate information screen selection button to display climate information on the screen.

Air conditioning for driver only



ODEEV068183NR

- Press the DRIVER ONLY button  and the indicator light illuminates, cold air mostly blows in the direction of the driver's seat. However, some of the cold air may come out of other seats' ducts to keep indoor air pleasant.

If you use the button with no passenger in the front passenger seat, energy consumption will be reduced.

Automatic ventilation

The system automatically selects the outside (fresh) air position when the climate control system operates over a certain period of time (5 minutes) in low temperature with the recirculated air position selected.

To cancel or reset the Automatic Ventilation

When the air conditioning system is on, select Face Level  mode and press the recirculated air position

button more than five times within 3 seconds while pressing A/C button.



When the automatic ventilation is canceled, the indicator blinks 3 times. When the automatic ventilation is activated, the indicator blinks 6 times.

System operation

Ventilation

1. Set the mode to the  position.
2. Set the air intake control to the outside (fresh) air position.
3. Set the temperature control to the desired position.
4. Set the fan speed control to the desired speed.

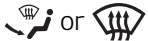
Heating

1. Set the mode to the  position.
2. Set the air intake control to the outside (fresh) air position.
3. Set the temperature control to the desired position.
4. Set the fan speed control to the desired speed.
5. If dehumidified heating is desired, turn the air conditioning system (if equipped) on.
 - If the windshield fogs up, set the mode to the  or  position.

Operation Tips

- To keep dust or unpleasant fumes from entering the vehicle through the ventilation system, temporarily set the air intake control to the recirculated air position. Be sure to return the control to the fresh air position when the irritation has passed to keep fresh air in the vehicle. This will help keep the driver alert and comfortable.
- Air for the heating/cooling system is drawn in through the grilles just ahead of the windshield. Care should be taken that these are not blocked by leaves, snow, ice or other obstructions.
- To prevent interior fog on the windshield, set the air intake control to the fresh air position and fan speed to the desired position, turn on the air conditioning system, and adjust the temperature control to desired temperature.

Air conditioning (if equipped)

All Kia Air Conditioning Systems are filled with R-1234yf refrigerant.

1. Start the vehicle. Press the air conditioning button.
2. Set the mode to the  position.
3. Set the air intake control to the outside-air or recirculated air position.
4. Adjust the fan speed control and temperature control to maintain maximum comfort.

- When maximum cooling is desired, set the temperature control to the extreme left position, set the mode control to the MAX A/C position, then set the fan speed control to the highest speed.

CAUTION

Excessive A/C Use

When using the air conditioning system, monitor the temperature gauge closely while driving up hills or in heavy traffic when outside temperatures are high. Air conditioning system operation may cause vehicle overheating. Continue to use the blower fan but turn the air conditioning system off if the temperature gauge indicates vehicle overheating.

CAUTION

When opening the windows in humid weather, air conditioning may create water droplets inside the vehicle. Since excessive water droplets may cause damage to electrical equipment, air conditioning should only be used with the windows closed.

Air conditioning system operation tips

- If the vehicle has been parked in direct sunlight during hot weather, open the windows for a

short time to let the hot air inside the vehicle escape.

- To help reduce moisture inside of the windows on rainy or humid days, decrease the humidity inside the vehicle by operating the air conditioning system.
- During air conditioning system operation, you may occasionally notice a slight change in vehicle speed as the air conditioning compressor cycles. This is a normal system operation characteristic.
- Use the air conditioning system every month only for a few minutes to ensure maximum system performance.
- When using the air conditioning system, you may notice clear water dripping (or even puddling) on the ground under the passenger side of the vehicle. This is a normal system operation characteristic.
- Operating the air conditioning system in the recirculated air position provides maximum cooling; however, continual operation in this mode may cause the air inside the vehicle to become stale.
- During cooling operation, you may occasionally notice a misty air flow because of rapid cooling and humid air intake. This is a normal system operation characteristic.

Climate control air filter (if equipped)

The climate control air filter installed behind the glove box filters the dust or other pollutants that come into the vehicle from the outside through the heating and air conditioning system.

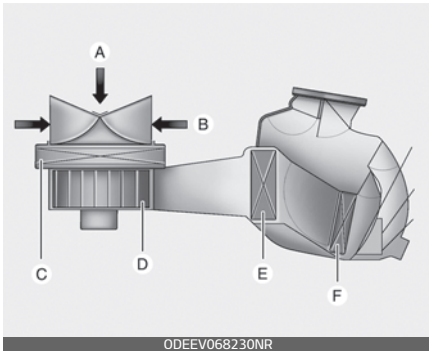

ODDEV068230NR

- A: Outside air
- B: Recirculated air
- C: Climate control air filter
- D: Blower
- E: Evaporator core
- F: Heater core

If dust or other pollutants accumulate in the filter over a period of time, the air flow from the air vents may decrease, resulting in moisture accumulation on the inside of the windshield even when the outside (fresh) air position is selected. If this happens, have the climate control air filter replaced by an authorized Kia dealer.

* NOTICE

- Replace the filter every 15,000 miles or once a year. If the vehicle is being driven in severe conditions such as dusty or rough roads, more frequent air conditioner filter inspections and changes are required.
- When the air flow rate suddenly decreases, the system should be checked at an authorized Kia dealer.

Checking the amount of air conditioner refrigerant and compressor lubricant

When the amount of refrigerant is low, the performance of the air conditioning is reduced. Overfilling also has a negative impact on the air conditioning system.

Therefore, if abnormal operation is found, have the system inspected by an authorized Kia dealer.

⚠ WARNING

The oil and refrigerant in your vehicle's air conditioning system is under very high pressure. If proper service procedures are not followed an explosion may result. To reduce the risk of serious injury or death, the air conditioning system in your vehicle should only be serviced by trained and certified technicians.

⚠ CAUTION

It is important that the correct type and amount of oil and refrigerant is used, otherwise damage to the vehicle may occur. To prevent damage, the air conditioning system in your vehicle should only be serviced by trained and certified technicians.

⚠ WARNING**Vehicles equipped with R-1234yf**

Because the refrigerant is mildly inflammable and at very high pressure, the air conditioning system should only be serviced by trained and certified technicians.

It is important that the correct type and amount of oil and refrigerant is used.

Otherwise, it may cause damage to the vehicle and personal injury.

Air Conditioning refrigerant label

Example



ODEEV068189NR

* The actual Air Conditioning refrigerant label in the vehicle may differ from the illustration.

Each symbol and specification on the air conditioning refrigerant label is represented below:



1. Classification of refrigerant
2. Amount of refrigerant
3. Classification of Compressor lubricant

Refer to "Refrigerant label" on page 9-8 for more detail on the location of air conditioning refrigerant label.

Windshield defrosting and defogging

When the windshield is covered with frost or moisture, the front view is blurred, so you should remove the frost and moisture.

⚠ WARNING**Windshield heating**

Do not use the  or  position during cooling operation in extremely humid weather. The difference between the temperature of the outside air and the windshield could cause the outer surface of the windshield to fog up, causing loss of visibility. In this case, set the mode selection to the  position and fan speed control to the lower speed.

- For maximum defrosting, set the temperature control to the extreme right/hot position and the fan speed control to the highest speed.
- If warm air to the floor is desired while defrosting or defogging, set the mode to the floor-defrost position.
- Before driving, clear all snow and ice from the windshield, rear window, outside rear view mirrors, and all side windows.
- Clear all snow and ice from the hood and air inlet in the cowl grill to improve heater and defroster efficiency and to reduce the probability of fogging up the inside of the windshield.

Defogging inside windshield with the automatic climate control

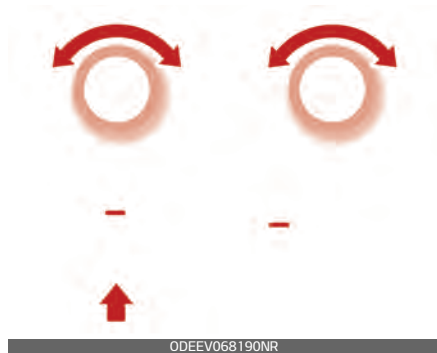

1. Set the fan speed to the desired position.
2. Select desired temperature.
3. Press the defroster button ().
4. The outside (fresh) air position will be selected automatically and the air conditioning will turn on according to the detected ambient temperature.

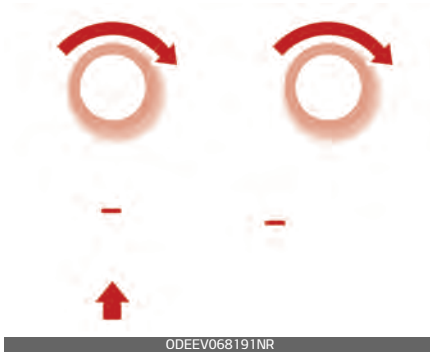

If the air conditioning and outside (fresh) air position are not selected automatically, adjust the corresponding button manually. If the  position is selected, lower fan speed is adjusted to a higher fan speed.

Defrosting outside windshield with automatic climate control



1. Set the fan speed to the highest position.
2. Set the temperature to the extreme hot (HI) position.
3. Press the defroster button ()
4. The outside (fresh) air position will be selected automatically and the air conditioning will turn on according to the detected ambient temperature.

Defogging logic (if equipped)

To reduce the possibility of fogging up the inside of the windshield, the air intake or air conditioning is controlled automatically according to certain conditions such as  or  position.

To cancel automatic defogging logic or return to the automatic defogging logic, do the following.

Turning the defogging logic on or off



1. Turn the POWER button to the ON position.
2. Press the defroster button ()
3. While pressing the air conditioning button (A/C), press the air intake control button at least 5 times within 3 seconds.

The recirculation indicator blinks 3 times in 0.5 second of intervals. It indicates that the defogging logic is canceled or returned to the programmed status.

If the battery has been discharged or disconnected, it resets to the defog logic status.

Auto defogging system (if equipped)

Auto defogging reduces the probability of fogging up the inside of the windshield by automatically sensing the moisture of inside the windshield.



ODEEV068193NR

The auto defogging system operates when the heater or air conditioning is on.

The indicator illuminates when the auto defogging system senses the moisture on the inside of the windshield and operates.

The auto defogging system addresses excess moisture on the inside of the windshield in stages. For example if auto defogging does not defog inside the windshield at step 1 Outside air position, it tries to defog again at step 2 Operating the air conditioning.

1. Outside air position
2. Operating the air conditioning

3. Increasing air flow toward the windshield
4. Blowing air flow toward the windshield

Turning the auto defogging system on or off

- Press the front windshield defroster button for 3 seconds when the POWER button is in the ON position.

When the ADS system is canceled, the defroster button indicator will blink 3 times per 0.5 sec.

When the ADS system is reset, the defroster button indicator will blink 6 times per 0.25 sec.

⚠ CAUTION

Do not remove the sensor cover located on the upper end of the passenger side windshield glass. Damage to the system parts could occur and may not be covered by your vehicle warranty.

Storage compartment

These compartments can be used to store small items required by the driver or passengers.

- To avoid possible theft, do not leave valuables in the storage compartment.
- Always keep the storage compartment covers closed while driving. Do not attempt to place so many items in the storage compartment that the storage compartment cover cannot close securely.

⚠ WARNING

Flammable materials

Do not store, propane cylinders or other flammable/explosive materials in the vehicle. These items may catch fire and/or explode if the vehicle is exposed to hot temperatures for extended periods.

Center console storage



ODEEV068194NR

To open the center console storage:

- Pull up the lever.

Glove box



ODEEV068195NR

To open the glove box:

- Push the lever and the glove box will automatically open.

Close the glove box after use.

⚠ WARNING

Glove Box

To reduce the risk of injury in an accident or sudden stop, always keep the glove box door closed while driving.

*** NOTICE**

If the temperature control switch is in the warm or hot position, warm or hot air will flow into the glove box.

Sunglass holder



ODEEV068196NR

To open the sunglasses holder:

- Press the cover and the holder will slowly open.

Place your sunglasses with the lenses facing out. To close the sunglasses holder push it up.

⚠ WARNING

Sunglass holder

- Do not keep objects except sunglasses inside the sunglasses holder. Such objects can be thrown from the holder in the event of a sudden stop or an accident, possibly injuring the passengers in the vehicle.
- Do not open the sunglasses holder while the vehicle is moving. The rear view mirror of the vehicle can be blocked by an opened sunglasses holder.

Luggage box



ODEEV068197NR

You can place tools, etc. in the box for easy access.

- Grasp the handle on the edge of the cover and lift it.

Interior features

There are various features inside the vehicle for the convenience of the occupants.

Cup holder

The front and rear seats of the vehicle have cup holders to accommodate cups.

⚠ WARNING

Hot liquids

Do not place uncovered cups with hot liquid in the cup holder while the vehicle is in motion. If the hot liquid spills, you may burn yourself. Such a burn to the driver could lead to loss of control of the vehicle.

⚠ CAUTION

- Keep your drinks sealed while driving to prevent spilling your drink. If liquid spills, it may get into the vehicle's electrical/electronic system and damage electrical/electronic parts.
- When cleaning spilled liquids, do not use heat to dry the cup holders. This may damage the cup holder.

- To open the cover, slightly press the upper part of the cover (1) and slide down the cover (2) as indicated in the picture below.

Front seat



ODEEV068198NR

- To use the cup holder, press the button (1).



ODEEV068199NR

The cup holder (2) will appear.

⚠ CAUTION

Be careful not to spill drinks in the cup holder. The cup holder may not work.

- To use the cup holder space as a storage compartment, turn the cup holder (2) the direction of the arrow.



ODEEV068200NR

Cups or small beverage cans may be placed in the cup holders.

Rear seat



ODEEV068201NR

Seat warmer (if equipped)

The seat warmer is provided to warm the front seats during cold weather.



ODEEV068202NR

With the POWER button in the ON position:

- Push either of the switches to warm the driver's seat or the front passenger's seat.

During mild weather or under conditions where the operation of the seat warmer is not needed, keep the switches in the "OFF" position.

Temperature control (Manual)

Each time you press the switch, the temperature setting of the seat will change as follows:

Front seat

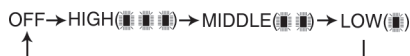

The seat warmer defaults to the OFF position whenever the POWER button is turned on.

Temperature control (Automatic)

The seat warmer starts to automatically control the seat temperature in order to prevent low-temperature burns after being manually turned ON.

Front seat

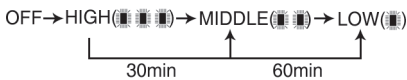

You may manually press the button to increase the seat temperature. However, it soon returns to the automatic mode again. When pressing the switch for more than 1.5 seconds with the seat warmer operating, the seat warmer will turn OFF. The seat warmer defaults to the OFF position whenever the power button is in the ON position.

* NOTICE

With the seat warmer switch in the ON position, the heating system in the seat turns off or on automatically depending on the seat temperature.

⚠ WARNING

Seat warmer burns

The seat warmer may cause burns, even at low temperature, if used over a long period of time. Never allow passengers who may not be able to take care of themselves to be exposed to the risk of seat heater burns. These include:

1. Infants, children, elderly or disabled persons, or hospital outpatients
2. Persons with sensitive skin or those that burn easily
3. Fatigued individuals
4. Intoxicated individuals
5. Individuals taking medication that can cause drowsiness or sleepiness (sleeping pills, cold tablets, etc.)

Air ventilation seat (if equipped)



ODEEV068204NR

The temperature setting of the seat changes according to the switch position.

- To ventilate your seat cushion, press the switch (blue color). Each time you press the button, the airflow will change as follows:

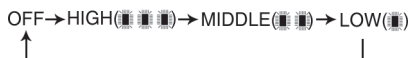

The seat warmer (with air ventilation) defaults to the OFF position whenever the POWER button is turned on.

⚠ CAUTION

Seat damage

- When cleaning the seats, do not use an organic solvent such as paint thinner, benzene, alcohol and gasoline. Doing so may damage the air ventilation seat.
- Do not place heavy or sharp objects on the seat. Those things may damage the air ventilation seat.
- Be careful not to spill liquid such as water or beverages on the seat. If you spill some liquid, wipe the seat with a dry towel. Before using the air ventilation seat, dry the seat completely.

Sun visor

Use the sun visor to shield direct light through the front or side windows.



ODEEV06823 1NR

- * The actual sun visor lamp in the vehicle may differ from the illustration.
- To use the sun visor, pull it downward.
- To use the sun visor for the side window, pull it downward, unsnap it from the bracket (1) and swing it to the side (2).
- To use the vanity mirror, pull down the visor and slide the mirror cover (3). Adjust the sun visor extension forward or backward (4). The ticket holder (5) is provided for holding a tollgate ticket (if equipped)

⚠ CAUTION

Vanity mirror lamp

If you use the vanity mirror lamp, turn off the lamp before returning the sun visor to its original position, otherwise it could result in battery discharge and possible sun visor damage.

Power outlet (if equipped)

The power outlet is designed to provide power for mobile telephones or other devices designed to operate with vehicle electrical systems.



0DEEV068205NR

The devices should draw less than 10 amps with the vehicle on.

- Use the power outlet only when the vehicle is on and remove the accessory plug after use. Using the accessory plug for prolonged periods of time with the vehicle off could cause the battery to discharge.
- Only use 12 V electric accessories which are less than 10 A in electric capacity
- Adjust the air-conditioner or heater to the lowest operating level when using the power outlet.
- Close the cover when not in use.

- Some electronic devices can cause electronic interference when plugged into a vehicle's power outlet. These devices may cause excessive audio static and malfunctions in other electronic systems or devices used in your vehicle.
- Push the plug in as far as it will go. If good contact is not made, the plug may overheat and the fuse may open.
- Plug in battery equipped electronic devices with reverse current protection. The current from the battery may flow into the vehicle's electrical/electronic system and cause system malfunction.

⚠ WARNING

Electric shock

Do not put a finger or a foreign object (pen, etc.) into a power outlet and do not touch with a wet hand. You may get an electric shock.

USB charger (if equipped)

The USB charger is designed to recharge batteries of small size electrical devices using a USB cable.



ODEEV068206NR

The electrical devices can be recharged when the power button is in ACC/ON position.

The battery charging state may be monitored on the electrical device.

Disconnect the USB cable from the USB port after use.

* NOTICE

- Some devices are not supported for fast charging but will be charged with normal speed.
- Use the USB charger when the vehicle is on to prevent battery discharge.
- Only devices that fit the USB port can be used.
- The USB charger can be used only for battery charging purposes.
- Battery chargers cannot be charged.

Wireless smart phone charging system (if equipped)

A wireless smart phone charging system is located in front of the center console.



ODEEV068207NR

Firmly close all doors, and turn vehicle on. To start wireless charging, place the smart phone equipped with wireless charging function on the wireless charging pad.

For best wireless charging results, place the smart phone on the center of the charging pad.

The wireless charging system is designed for one smart phone equipped with Qi per single usage only. Please refer to the smart phone accessory cover or the smart phone manufacturer homepage to check whether your smart phone supports Qi function.

Charging wireless smart phone

1. Remove any object on the smart phone charging pad including the smart key. If there is any foreign object on the pad other than a smart phone, the wireless charging function may not operate properly.
2. Place the smart phone on the center of the wireless charging pad.
The indicator light will change to orange once the wireless charging begins. After the charging is complete, the orange light will change to green.

You can choose to turn the wireless charging function to either ON or OFF by selecting the USM on the instrument cluster. (Please refer to "Instrument cluster" on page 5-46 for details).

If the wireless charging does not work, gently move your smart phone around the pad until the charging indicator light turns orange.

Depending on the smart phone, the charging indicator light may not turn green even after the charging is complete.

If the wireless charging is not functioning properly, the orange light will blink and flash for ten seconds then turn off. In such cases, remove the smart phone from the pad and replace it on the pad again, or double check the charging status.

If you leave the smart phone on the charging pad when the vehicle is turned off, the vehicle will alert you through warning messages and sound (applicable for vehicles with voice guidance function) after the 'Good bye' function on the instrument cluster ends.

⚠ WARNING

Distracted driving

Driving while distracted can result in a loss of vehicle control that may lead to an accident, severe bodily injury, and death. The driver's primary responsibility is in the safe and legal operation of a vehicle, and use of any handheld devices, other equipment, or vehicle systems which take the driver's eyes, attention and focus away from the safe operation of a vehicle or which are not permissible by law should never be used during operation of the vehicle.

⚠ CAUTION**Liquid in Wireless Smart Phone Charger**

To prevent liquid from damaging the wireless smart phone charging system in your vehicle, be sure not to spill liquid over the charging system when charging your phone.

⚠ CAUTION**Metal in Wireless Charging System**

If any metallic object such as a coin is located between the wireless charging system and the smart phone, the charging may be disrupted. Also, the metallic object may heat up and potentially damage the charging system. If there is any metallic object between the smart phone and the charging pad, immediately remove the smart phone. Remove the metallic object after it has cooled down.

*** NOTICE**

- When the interior temperature of the wireless charging system rises above a set temperature, the wireless charging will cease to function. After the interior temperature drops below the threshold, the wireless charging function will resume.
- The wireless charging may not function properly when there is a heavy accessory cover on the smart phone.
- The wireless charging will stop when using the wireless smart key search function to prevent radio wave disruption.
- The wireless charging will stop when the smart key is moved out of the vehicle with the vehicle in ON.
- The wireless charging will stop when any of the doors are opened (applicable for vehicles equipped with smart keys).
- The wireless charging will stop when the vehicle is turned OFF.
- The wireless charging will stop when the smart phone is not in complete contact with the wireless charging pad.
- Items equipped with magnetic components such as credit card, telephone card, bankbook or any transportation ticket may become damaged during wireless charging.

- Place the smart phone on the center of the charge pad for best results. The smart phone may not charge when placed near the rim of the charging pad. When the smart phone does get charged, it may heat up excessively.
- For smart phones without built-in wireless charging system, an appropriate accessory has to be equipped in order to use the vehicle's wireless charging system.
- Smart phones of some manufacturers may display messages on weak current. This is due to the particular characteristic of the smart phone and does not imply a malfunction on wireless charging function.
- The indicator light of some manufacturers' smart phones may still be orange after the smart phone is fully charged. This is due to the particular characteristic of the smart phone and not a malfunction of the wireless charging.
- When any smart phone without a wireless charging function or a metallic object is placed on the charging pad, a small noise may sound. This small sound is due to the vehicle discerning compatibility of the object placed on the charging pad. It does not affect your vehicle or the smart phone in any way.
- The wireless cellular phone charging system may not support certain cellular phones, which are not verified for Qi specification(Qi).
- When placing your cellular phone on the charging mat, position the phone in the middle of the mat for optimal charging performance. If your cell phone is off to the side, the charging rate may be less and in some cases the cell phone may experience higher heat conduction.
- When charging some cellular phones with a self-protection feature, the wireless charging speed may decrease and the wireless charging may stop.

This device complies with part 15 of the FCC Rules

Operation is subject to the following two conditions:

1. This device may not cause harmful interference, and
2. This device must accept any interference received, including interference that may cause undesired operation.

Coat hook (if equipped)

A Coat hook is next to the rear grab handle.



ODEEV068208NR

* This actual feature may differ from the illustration.

⚠ CAUTION

Hanging clothing

Do not hang heavy clothes, since they may damage the hook.

⚠ WARNING

Do not hang other objects such as hangers or hard objects except clothes. Also, do not put heavy, sharp or breakable objects in the clothing's pockets. In an accident or when the curtain air bag is inflated, it may cause vehicle damage or personal injury.



ODEEV068209NR

Floor mat anchor(s) (if equipped)

Type A / Type B

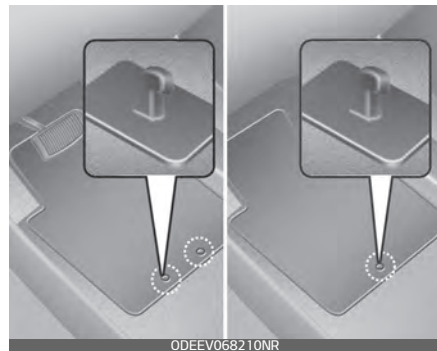

ODEEV068210NR

When using a floor mat on the front floor carpet, make sure it attaches to the floor mat anchor(s) in your vehicle. This keeps the floor mat from sliding forward.

⚠ WARNING

After market floor mat

Do not install after market floor mats that are not capable of being securely attached to the vehicle's floor mat anchors.

Unsecured floor mats can interfere with pedal operation.

The following must be observed when installing ANY floor mat to the vehicle.

- Ensure that the floor mats are securely attached to the vehicle's floor mat anchor(s) before driving the vehicle.
- Do not use ANY floor mat that cannot be firmly attached to the vehicle's floor mat anchors.
- Do not stack floor mats on top of one another (e.g. all-weather rubber mat on top of a carpeted floor mat). Only a single floor mat should be installed in each position.

*** NOTICE**

Your vehicle was manufactured with driver's side floor mat anchors that are designed to securely hold the floor mat in place. To avoid any interference with pedal operation, Kia recommends that only the Kia floor mat designed for use in your vehicle be installed.

Luggage net holder (if equipped)

To keep items from shifting in the cargo area, you can use the holders located in the cargo area to attach the luggage net.

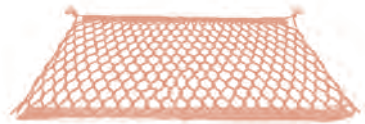

0DEEV06821 1NR

If necessary, we recommend that you contact an authorized Kia dealer.

⚠ CAUTION

To prevent damage to the vehicle, care should be taken when carrying fragile or bulky objects in the luggage compartment.

⚠ WARNING**Luggage net**

Always keep your face and body out of the luggage net recoil path and avoid using the luggage net when the straps have visible signs of wear or damage. The luggage net can snap and cause injuries.

Cargo security screen (if equipped)

Use the cargo security screen to hide items stored in the cargo area.

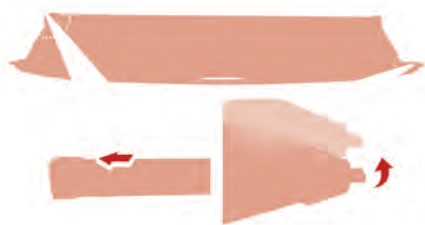

ODEEV068212NR

- To use the cargo security screen, pull the handle backward and insert the edges into the slots.

⚠ WARNING**Cargo Security Screen**

Do not place objects on the cargo security screen. Such objects may be thrown about inside the vehicle and possibly injure vehicle occupants during an accident or when braking.

⚠ CAUTION

Do not place luggage on the cargo security screen. This may cause the security screen to become damaged or malformed.

Exterior features

If the vehicle has a roof rack, you can load cargo on top of your vehicle.

Roof rack (if equipped)



0DEEV068213NR

Crossbars and fixing components needed to install the roof rack on your vehicle may be obtained from an authorized Kia dealer or other qualified shop.

* NOTICE

- The crossbars (if equipped) should be placed in the proper load carrying positions prior to placing items onto the roof rack.
- If the vehicle is equipped with a sunroof, be sure not to position cargo onto the roof rack in such a way that it could interfere with sunroof operation.
- When the roof rack is not being used to carry cargo, the crossbars may need to be repositioned if wind noise is detected.

⚠ CAUTION

Loading Roof Rack

- When carrying cargo on the roof rack, take the necessary precautions to make sure the cargo does not damage the roof of the vehicle.
 - When carrying large objects on the roof rack, make sure they do not exceed the overall roof length or width.
 - When you are carrying cargo on the roof rack, do not operate the sunroof (if equipped). This can damage the sunroof.
-
- The following specification is the maximum weight that can be loaded onto the roof rack. Distribute the load as evenly as possible across the crossbars (if equipped) and roof rack and secure the load firmly.

ROOF RACK	220 lbs. (100 kg) EVENLY DISTRIBUTED
-----------	---

Loading cargo or luggage in excess of the specified weight limit on the roof rack may damage your vehicle.

⚠ WARNING

- The vehicle center of gravity will be higher when items are loaded onto the roof rack. Avoid sudden starts, braking, sharp turns, abrupt maneuvers or high speeds that may result in loss of vehicle control or rollover resulting in an accident.
- Always drive slowly and turn corners carefully when carrying items on the roof rack. Severe wind updrafts, caused by passing vehicles or natural causes, can cause sudden upward pressure on items loaded on the roof rack. This is especially true when carrying large, flat items such as wood panels or mattresses. This could cause the items to fall off the roof rack and cause damage to your vehicle or others around you.

-
- To prevent damage or loss of cargo while driving, check frequently before or while driving to make sure the items on the roof rack are securely fastened.

⚠ WARNING**Driving with roof load**

Always drive slow and turn corners carefully when carrying items on the roof rack. The vehicle's center of gravity will be higher when items are loaded onto the roof rack.

Audio system*** NOTICE**

If you install an after market HID head lamp, your vehicle's audio and electronic device may malfunction.

-
- * If your vehicle is equipped with multimedia system, refer to a separately supplied manual for detailed information.

Antenna

This vehicle is equipped with a glass antenna and a shark fin antenna.

Shark fin antenna

0DEEV0682 14NR

The shark fin antenna will receive the transmit data.

USB port

You can use an USB port to plug in an USB or iPod®.



ODDEEV068215NR

* NOTICE

When using a portable audio device connected to the power outlet, noise may occur during playback. If this happens, use the power source of the portable audio device.

* iPod® is a trademark of Apple Inc.

How vehicle radio works

FM reception

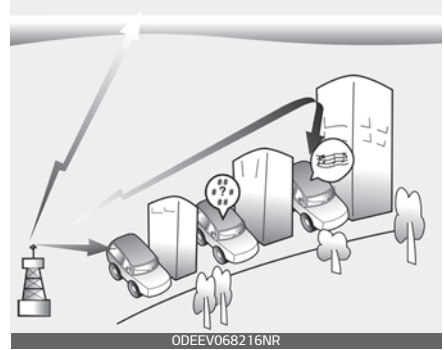

ODDEEV068216NR

AM and FM radio signals are broadcast from transmitter towers located around your city. They are intercepted by the radio antenna on your vehicle. This signal is then processed by the radio and sent to your vehicle speakers.

However, in some cases the signal coming to your vehicle may not be strong and clear.

This can be due to factors, such as the distance from the radio station, closeness of other strong radio stations or the presence of buildings, bridges or other large obstructions in the area.

AM reception

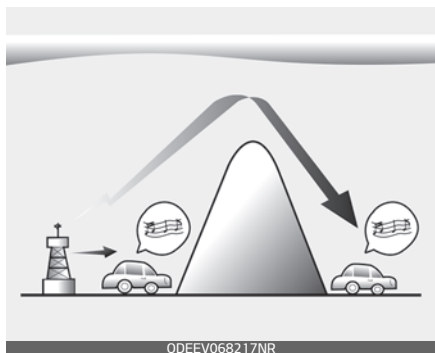

AM broadcasts can be received at greater distances than FM broadcasts. This is because AM radio waves are transmitted at low frequencies. These long distance, low frequency radio waves can follow the curvature of the earth rather than traveling straight. In addition, they curve around obstructions resulting in better signal coverage.

FM radio station

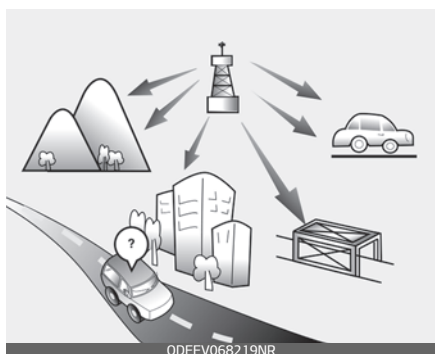

FM broadcasts are transmitted at high frequencies and do not bend to follow the earth's surface. Because

of this, FM broadcasts generally begin to fade within short distances from the station. Also, FM signals are easily affected by buildings, mountains, and obstructions. This can lead to undesirable or unpleasant listening conditions which might lead you to believe a problem exists with your radio.

The following conditions are normal and do not indicate radio trouble:

- Fading – As your vehicle moves away from the radio station, the signal will weaken and sound will begin to fade. When this occurs, we suggest that you select another station with a stronger signal.

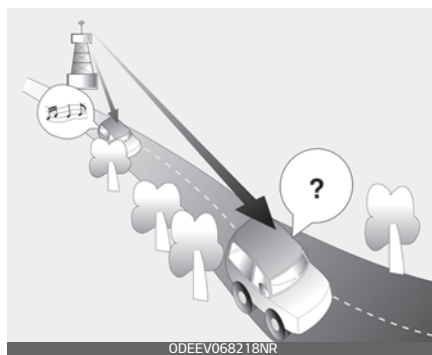

- Flutter/Static – Weak FM signals or large obstructions between the transmitter and your radio can disturb the signal causing static or fluttering noises to occur. Reducing the treble level may lessen this effect until the disturbance clears.

- Station Swapping – As an FM signal weakens, another more powerful signal near the same frequency may begin to play. This is because your radio is designed to lock onto the clearest signal. If this occurs, select another station with a stronger signal.

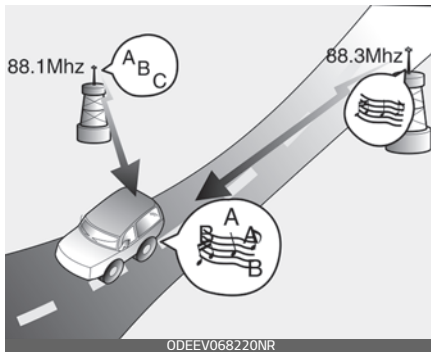

- Multi-Path Cancellation – Radio signals being received from several directions can cause distortion or fluttering. This can be caused by a direct and reflected signal from the same station, or by signals from two stations with close frequencies. If this occurs, select another station until the condition has passed.

Using a cellular phone or a two-way radio

When a cellular phone is used inside the vehicle, noise may be produced from the audio system. This does not mean that something is wrong with the audio equipment. In such a case, try to operate mobile devices

as far from the audio equipment as possible.

When using a communication system such as a cellular phone or a radio set inside the vehicle, a separate external antenna must be fitted. When a cellular phone or a radio set is used with an internal antenna alone, it may interfere with the vehicle's electrical system and adversely affect safe operation of the vehicle.

⚠ WARNING

Cell phone use

Do not use a cellular phone while driving. Stop at a safe location to use a cellular phone.

⚠ WARNING

Distracted driving

Driving while distracted can result in a loss of vehicle control that may lead to an accident, severe bodily injury, or death. The driver's primary responsibility is the safe and legal operation of the vehicle, and the use of any handheld devices, other equipment, or vehicle systems which take the driver's eyes, attention, and focus away from the safe operation of the vehicle, or which are not permissible by law, should never be used during the operation of the vehicle.

Declaration of Conformity

FCC

This equipment has been tested and found to comply with the limits for a Class B digital device, pursuant to part 15 of the FCC Rules. These limits are designed to provide reasonable protection against harmful interference in a residential installation.

This equipment generates, uses and can radiate radio frequency energy and, if not installed and used in accordance with the instructions, may cause harmful interference to radio communications. However, there is no guarantee that interference will not occur in a particular installation. If this equipment does cause harmful interference to radio or television reception, which can be determined by turning the equipment off and on, the user is encouraged to try to correct the interference by one or more of the following measures:

- Reorient or relocate the receiving antenna.
- Increase the separation between the equipment and receiver.
- Connect the equipment into an outlet on a circuit different from that to which the receiver is connected.

- Consult the dealer or an experienced radio/TV technician for help.

CAUTION

Any changes or modifications to this device not explicitly approved by manufacturer could void your authority to operate this equipment.

This device complies with part 15 of the FCC Rules. Operation is subject to the following two conditions:

1. This device may not cause harmful interference, and
2. This device must accept any interference received, including interference that may cause undesired operation.

This equipment complies with FCC radiation exposure limits set forth for an uncontrolled environment.

This equipment should be installed and operated with minimum 8 in (20 cm) between the and your body. This transmitter must not be collocated or operating in conjunction with any other antenna or transmitter unless authorized to do so by the FCC.

Before driving	6-5
Power button	6-6
• Starting the vehicle	6-8
• Turning Off the Vehicle	6-9
Reduction gear	6-10
• Reduction Gear Operation	6-10
• Parking	6-12
• LCD Display Messages	6-12
• Good Driving Practices	6-15
Regenerative braking system	6-16
Smart regeneration system (If equipped with smart cruise control)	6-19
• Setting Smart Regeneration System	6-19
• Smart Regeneration System Activation	6-19
• Resuming Smart Regeneration System	6-21
• Turning Smart Regeneration system off	6-21
• Vehicle-to-Vehicle Distance Recognition Sensor (Front Radar)	6-21
• System Malfunction	6-22
• Limitations of the System	6-23
• This device complies with Part 15 of the FCC rules.	6-26
• Radio frequency radiation exposure information:	6-26
Brake system	6-27
• Power brakes	6-27
• Electronic parking brake (EPB)	6-28
• AUTO HOLD	6-33
• Anti-lock brake system (ABS)	6-37
• Electronic stability control (ESC)	6-39

6 Driving your vehicle

- Vehicle stability management (VSM) 6-42
- Hill-start Assist Control (HAC)..... 6-44
- Good braking practices 6-44
- Forward Collision-Avoidance Assist (FCA) (Smart Cruise Control System Equipped)..... 6-45**
 - Setting and activating the FCA 6-46
 - Setting the initial warning activation time..... 6-46
 - Prerequisite for the FCA activation..... 6-47
 - FCA warning message and brake control..... 6-47
 - Brake operation 6-48
 - FCA front radar / Camera sensor 6-49
 - Warning message and warning light..... 6-50
 - FCA malfunction 6-51
 - Limitations of the FCA..... 6-53
 - Recognizing pedestrians 6-57
 - This device complies with Part 15 of the FCC rules. 6-58
 - Radio frequency radiation exposure information: 6-58
- Smart Cruise Control with Stop & Go System 6-59**
 - Smart Cruise Control switch..... 6-60
 - Setting Smart Cruise Control speed 6-61
 - Increasing Smart Cruise Control set speed 6-62
 - Decreasing Smart Cruise Control set speed 6-62
 - Accelerating temporarily with Smart Cruise Control on.... 6-62
 - Smart Cruise Control will be temporarily canceled when: 6-63
 - Resuming Smart Cruise Control set speed 6-65
 - Turning Smart Cruise Control off..... 6-65
 - Setting vehicle-to-vehicle distance..... 6-65
 - When the lane ahead is clear: 6-66
 - When there is a vehicle ahead of you in your lane:..... 6-67

- Adjusting the sensitivity of Smart Cruise Control 6-70
- Converting to Cruise Control mode 6-71
- Limitations of the Smart Cruise Control 6-71
- This device complies with Part 15 of the FCC rules. 6-76
- Radio frequency radiation exposure information:..... 6-76
- Drive mode integrated control system..... 6-76**
- Blind-Spot Collision Warning 6-78**
- Blind-Spot Collision Warning (BCW)..... 6-78
- Setting and activating the BCW 6-79
- Setting the warning volume of the Blind-Spot Collision Warning 6-80
- Operating Conditions 6-80
- Blind-Spot Collision Warning (BCW) alert 6-81
- Detecting Sensor (radar)..... 6-82
- Warning message 6-83
- Limitations of the BCW 6-84
- This device complies with Part 15 of the FCC rules. 6-88
- Rear Cross-Traffic Collision Warning (RCCW) 6-88**
- Rear Cross-Traffic Collision Warning (RCCW) system ... 6-88
- Setting and activating the RCCW..... 6-88
- Operating conditions 6-89
- Rear Cross-Traffic Collision Warning (RCCW) alert 6-89
- Detecting Sensor 6-90
- Warning message 6-91
- Limitations of the RCCW 6-92
- This device complies with Part 15 of the FCC rules. 6-96
- Driver Attention Warning (DAW) 6-96**
- Setting and activating the DAW 6-96
- Displaying the driver's attention level 6-97

6 Driving your vehicle

• Taking a break	6-98
• Resetting the Driver Attention Warning system	6-98
• DAW disabled	6-99
• DAW malfunction	6-99
Lane Following Assist (LFA).....	6-101
• Activating the LFA	6-102
• Steering assist	6-102
• Warning message	6-103
• LFA malfunction	6-103
• Limitations of the LFA	6-104
Lane Keeping Assist (LKA) System.....	6-106
• LKA operation.....	6-108
• LKA activation	6-108
• Warning message	6-109
• The system will be canceled when:.....	6-111
• Driver's Attention	6-111
• LKA malfunction	6-113
• LKA function change	6-113
Special driving conditions	6-114
Winter driving	6-118
Trailer towing	6-122
Vehicle load limit	6-123
• Steps For Determining Correct Load Limit -.....	6-123
• Certification label.....	6-125
Vehicle weight	6-127

DRIVING YOUR VEHICLE

Before driving

Before getting into the vehicle, you should examine the car and its surroundings. After getting into the vehicle, you should check a number of things before driving.

Before entering vehicle

- Be sure that all windows, outside mirror(s), and outside lights are clean.
- Check the condition of the tires.
- Check under the vehicle for any sign of leaks.
- Be sure there are no obstacles behind you if you intend to back up.

Before starting

- Close and lock all doors.
- Position the seat so that all controls are easily reached.
- Buckle your seat belt.
- Adjust the inside and outside rearview mirrors.
- Be sure that all lights work.
- Check all gauges.
- Check the operation of warning lights when the POWER button is turned to the ON position.
- Release the parking brake and make sure the brake warning light goes out.

For safe operation, be sure you are familiar with your vehicle and its equipment.

WARNING

Check surroundings

Always check the surrounding areas near your vehicle for people, especially children, before putting a vehicle into D (Drive) or R (Reverse).

WARNING

Loose objects

Securely store items in your vehicle. When you make a sudden stop or turn the steering wheel rapidly, loose objects may drop on the floor and it could interfere with the operation of the foot pedals, possibly causing an accident.

WARNING

Proper footwear

Always wear appropriate shoes when operating your vehicle. Unsuitable shoes (high heels, ski boots, sandals, etc.) may interfere with your ability to use the brake and accelerator pedals.

⚠ WARNING**Driving while intoxicated**

Do not drive while intoxicated. Drinking and driving is dangerous. Even a small amount of alcohol will affect your reflexes, perceptions and judgment.

Driving while under the influence of drugs is as dangerous as or more dangerous than driving drunk.

⚠ WARNING**Distracted driving**

Focus on the road while driving. The driver's primary responsibility is in the safe and legal operation of the vehicle. Use of any handled devices, other equipment or vehicle systems that distract the driver should not be used during vehicle operation.

Power button

Whenever the front door is opened, the POWER button will illuminate for your convenience.



ODEEV078001NR

The light will go off after about 30 seconds when the door is closed.

When all entrances are closed, if you lock the vehicle by using the transmitter or the smart key, the light will go off immediately.

POWER button position

The POWER button has the following four positions.

- OFF
- ACC (Accessory)
- ON
- START/RUN

OFF (Not Illuminated)

To turn off the vehicle power (ON position), press the POWER button with the shifter dial in the P (Park) position. When you press the POWER button without the shifter dial in the P (Park) position, the POWER button will not change to the OFF position but to the ACC position.

ACC (Accessory) - (Amber)

Press the POWER button while it is in the OFF position without depressing the brake pedal.

If the POWER button is in the ACC position for more than 1 hour, the button is turned off automatically to prevent battery discharge.

ON - (Red)

Press the POWER button while it is in the ACC position without depressing the brake pedal.

The warning lights can be checked before the vehicle is started. Do not leave the POWER button in the ON position for a long time. The battery may discharge, because the vehicle is not ON.

START/RUN (Not Illuminated)

To start the vehicle, depress the brake pedal and press the POWER button with the shifter dial in the P (Park) position. For your safety,

start the vehicle with the shifter dial in the P (Park) position.

If you press the POWER button without depressing the brake pedal, the vehicle will not start and the POWER button changes as follow: Go to OFF → ACC → ON → OFF or ACC

* NOTICE

If you leave the POWER button in the ACC or ON position for a long time, the battery will discharge.

⚠ WARNING

Starting vehicle

Never press the POWER button while the vehicle is in motion except in an emergency. This would result in loss of directional control and braking function, which could cause an accident.

⚠ WARNING



Leaving the Vehicle

To avoid unexpected or sudden vehicle movement, never leave your vehicle if the reduction gear is not locked in the P (Park) position and the parking brake is fully engaged. Before leaving the driver's seat, always make sure the reduction gear is engaged in P (Park), set the parking brake fully and shut the vehicle off.

Starting the vehicle

WARNING

Do not start the vehicle with the accelerator pedal depressed. The vehicle can move and lead to an accident.

- The vehicle will start by pressing the POWER button, only when the smart key is in the vehicle.
 - Even when the smart key is in the vehicle, if it is far away from the driver, the vehicle may not start.
 - When the POWER button is in the ACC or ON position, and any door is open, the system checks for the smart key. When the smart key is not in the vehicle, the " " indicator will blink and the warning "Key not in vehicle" will come on. When all doors are closed, the chime will also sound for about 5 seconds. Keep the smart key in the vehicle when in the ACC position or if the vehicle is ON.
1. Always carry the smart key with you.
 2. Make sure the parking brake is applied.
 3. Make sure the shifter dial is in P (Park).
 4. Depress the brake pedal.
 5. Press the POWER button. If the vehicle starts, the " " indicator will come on.

* NOTICE

- Always start the vehicle with your foot on the brake pedal.
- If ambient temperature is low, the " " indicator may remain illuminated longer than the normal amount of time.

* NOTICE

To prevent damage to the vehicle:

- If the " " indicator turns off while you are in motion, do not attempt to move the shifter dial to the P (Park) position. If traffic and road conditions permit, you may put the shifter dial in the N (Neutral) position while the vehicle is still moving and press the POWER button in an attempt to restart the vehicle.
- Do not push or tow your vehicle to start the vehicle.

WARNING

Unintended vehicle movement

Never leave the smart key in the vehicle with children or vehicle occupants who are unfamiliar with the vehicle operation. Pushing the POWER button while the smart key is in the vehicle may result in unintended vehicle activation and/or unintended vehicle movement.

If the battery is weak or the smart key does not work correctly, you can start the vehicle by pressing the POWER button with the smart key.



ODEEV078005NR

The side with the lock button should contact the POWER button directly.

When you press the POWER button directly with the smart key, the smart key should contact the button at a right angle.

When the stop lamp fuse is blown, you can't start the vehicle normally. Replace the fuse with a new one. If it is not possible, you can start the vehicle by pressing the POWER button for 10 seconds while it is in the ACC position. The vehicle can start without depressing the brake pedal. But for your safety always depress the brake pedal before starting the vehicle.

Do not press the POWER button for more than 10 seconds except when the stop lamp fuse is blown.

Turning Off the Vehicle

1. Depress the brake pedal fully.
2. Shift to P (Park).
3. Apply the parking brake.
4. Press the POWER button to turn the vehicle off.
5. Make sure the "⏻" indicator light on the instrument cluster is turned off.

⚠ CAUTION

If the "⏻" indicator light on the instrument cluster is still on, the vehicle is not turned off and can move when the gear is in any position except P (Park).

Reduction gear

Electric cars transmit the rotation of the motor to the wheel through the reducer.

Reduction Gear Operation

Select gear positions by turning the shifter dial.



ODEEV078006NR

⚠ WARNING

To reduce the risk of serious injury or death:

- ALWAYS check the surrounding areas near your vehicle for people, especially children, before shifting a vehicle into D (Drive) or R (Reverse).
- Before leaving the driver's seat, always make sure the gear is in the P (Park) position, then set the parking brake, and place the Power button in the OFF position. Unexpected and sudden vehicle movement can occur if these precautions are not followed.

For your safety, always depress the brake pedal while shifting to another gear.

Gear position



ODEEV078007NR

The indicator in the instrument cluster displays the gear position when the POWER button is in the ON position.

P (Park)

Always come to a complete stop before shifting into P (Park).

To shift the gear from R (Reverse), N (Neutral) or D (Drive) to P (Park), press the [P] button.

If you turn off the vehicle in D (Drive) or R (Reverse), the gear automatically shifts to P (Park).

With the vehicle on, the gear automatically shifts to P (Park) if you open the driver's door when the gear is in N (Neutral), R (Reverse) or D (Drive) and the following conditions are met:

- The brake/accelerator pedal is not depressed.
- The seat belt is unfastened.

- The vehicle speed is below 1 mph (2 km/h).

When the vehicle is over a certain speed, the gear does not shift to P (Park) when the P button is pressed.

WARNING

- Shifting into P (Park) while the vehicle is in motion may cause you to lose control of the vehicle.
- After the vehicle has stopped, always make sure the gear is in P (Park), apply the parking brake, and turn the vehicle off.
- Do not use the P (Park) position in place of the parking brake.

R (Reverse)

Use this position to drive the vehicle backward.

To shift to R (Reverse), press the [R] button while depressing the brake pedal.

CAUTION

Shifting

Always come to a complete stop before shifting into or out of R (Reverse); you may damage the reduction gear if you shift into R (Reverse) while the vehicle is in motion, except on "Rocking the vehicle" ("Rocking the vehicle" on page 6-115).

N (Neutral)

The wheels and gear are not engaged.

To shift to N (Neutral), press the [N] button while depressing the brake pedal.

Always depress the brake pedal when you are shifting from N (Neutral) to another gear.

In N (Neutral), if the driver attempts to turn off the vehicle, the gear remains in N (Neutral) and the POWER button will be in the ACC position.

To turn off the vehicle from the ACC position, press the [P] button within 3 minutes. The vehicle will shift to P (Park) and turn off.

When the driver's door is opened within 3 minutes with the POWER button in the ACC position and the gear in N (Neutral), the vehicle is automatically turned OFF and shifted to the P (Park) position.

D (Drive)

This is the normal driving position.

To shift to D (Drive), press the [D] button while depressing the brake pedal.

Shift-lock system

For your safety, your vehicle has a shift-lock system which prevents shifting the gear from P (Park) or N (Neutral) into R (Reverse) or D (Drive) unless the brake pedal is depressed.

To shift from P (Park) or N (Neutral) into R (Reverse) or D (Drive), from R (Reverse) into D (Drive) or from D (Drive) into R (Reverse):

1. Depress and hold the brake pedal.
2. Start the vehicle or place the POWER button in the ON position.
3. Press the R (Reverse) or D (Drive) button.

*** NOTICE**

For your safety, you cannot shift the gear while the charging cable is connected.

When the battery (12 V) is discharged

You cannot shift the gear when the battery is discharged.

Jump start your vehicle (refer to "Jump starting" on page 7-5) or contact an authorized Kia dealer.

Parking

1. Always come to a complete stop and continue to depress the brake pedal.
2. Shift to the P (Park) position.
3. Apply the parking brake.
4. Place the POWER button in the OFF position.
5. Take the Key with you when exiting the vehicle.

LCD Display Messages

If a message appears on the LCD display, refer to the next section for the appropriate steps to take.

Shifting conditions not met



The message appears on the LCD display in the following conditions:

1. When driving speed is too fast to shift the gear. Decrease the vehicle speed or slow down before shifting the gear.
2. When the gear is shifted while the vehicle is in Utility mode.

Press brake pedal to change gear

The message appears on the LCD display, when the brake pedal is not depressed while shifting the gear.

Depress the brake pedal and then shift the gear.

Shift to P after stopping

The message appears on the LCD display when the gear is shifted to P (Park) while the vehicle is moving.

Stop the vehicle before shifting to P (Park).

Gear already selected

The message appears on the LCD display when the selected gear button is pressed again.

PARK malfunction. Engage parking brake when parking vehicle

The message is displayed when there is a problem with function engaging P (Park) position.

Immediately have the vehicle inspected by an authorized Kia dealer.

Check P button



The message appears on the LCD display when there is problem with the P button.

Immediately have the vehicle inspected by an authorized Kia dealer.

Check shifter dial



The message appears on the LCD display when there is problem with the shift buttons.

Immediately have the vehicle inspected by an authorized Kia dealer

Rotary shifter stuck



The message appears on the LCD display when the shifter dial is continuously stuck or there is problem with the shifter dial.

Make sure that there is no object over the shifter dial. If the problem persists, immediately have the vehicle inspected by an authorized Kia dealer.

Shift button held down



The message appears on the LCD display when the shifter button is continuously pressed or there is problem with the button.

Make sure that there is no object over the shift button. If the problem persists, immediately have the system checked by an authorized Kia dealer.

Rotary shifter turned while pressing P

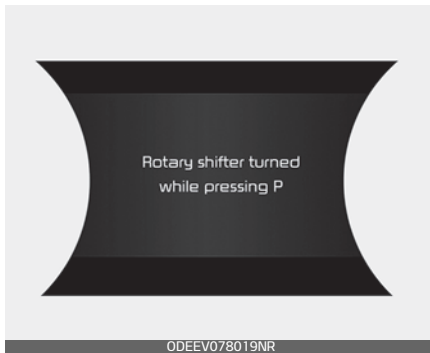

The message appears on the LCD display when the shift dial is not turned while pressing P button.

Make sure that shifter dial is not turned while pressing P button.

Good Driving Practices

Good driving habits reduce the risk of accidents and help maintain vehicle performance.

- Never shift from P (Park) or N (Neutral) to any other position with the accelerator pedal depressed.
- Never shift from P (Park) when the vehicle is in motion.

- Be sure the vehicle is completely stopped before you attempt to shift into R (Reverse) or D (Drive).
- Do not shift to N (Neutral) when driving. Doing so may result in an accident.
- Do not drive with your foot resting on the brake pedal. Even light, but consistent pedal pressure can result in the brakes overheating, brake wear and possibly even brake failure.
- Always apply the parking brake when leaving the vehicle. Do not depend on placing the gear in P (Park) to keep the vehicle from moving.
- Exercise extreme caution when driving on a slippery surface. Be especially careful when braking, accelerating or shifting gears. On a slippery surface, an abrupt change in vehicle speed can cause the drive wheels to lose traction and may cause loss of vehicle control resulting in an accident.
- Optimum vehicle performance and economy is obtained by smoothly depressing and releasing the accelerator.

⚠️ WARNING

To reduce the risk of **SERIOUS INJURY** or **DEATH**:

- ALWAYS wear your seat belt. In a collision, an unbelted occupant is significantly more likely to be seriously injured or killed than a properly belted occupant.
- Avoid high speeds when cornering or turning.
- Do not make quick steering wheel movements, such as sharp lane changes or fast, sharp turns.
- The risk of rollover is greatly increased if you lose control of your vehicle at highway speeds.
- Loss of control often occurs if two or more wheels drop off the roadway and the driver over steers to reenter the roadway.
- In the event your vehicle leaves the roadway, do not steer sharply. Instead, slow down before pulling back into the travel lanes.
- Kia recommends you follow all posted speed limits.

Regenerative braking system

The regenerative braking system allows you to charge the battery when you use the brakes to stop the vehicle.

Regenerative Braking (Paddle Shifter)

The paddle shifter is used to adjust the regenerative braking level from 0 to 3 during decelerating or braking.



ODEEV078020NR

- Left side (🔋⬅️): Increases regenerative braking and deceleration.
- Right side (🔋➡️): Decreases regenerative braking and deceleration.

Pull and hold the left side paddle shifter for more than 0.5 seconds and One Pedal Driving function is operated, increasing the regenerative braking. In this case, stopping the vehicle is possible by pulling the paddle shifter.

* Refer to "One pedal driving" on page 6-17.

With the Smart Regeneration System activated, pull and hold the right side paddle shifter for over 1 second to turn on and off the automatic change of the regenerative braking. However, nothing will happen if the Smart Regeneration System is not activated from the User Settings mode. To activate or deactivate the function go to 'User settings → Convenience → Smart Regeneration'.

* Refer to "Smart regeneration system (If equipped with smart cruise control)" on page 6-19.

*** NOTICE**

The paddle shifter does not operate when:

- The [←←←] and [←] paddle shifters are pulled at the same time.
- The vehicle is decelerating by depressing the brake pedal.
- The Cruise Control system or Smart Cruise Control system is activated.

The selected regenerative braking level is displayed on the instrument cluster.



Initial setting of the regenerative braking level and adjustable range vary according to the selected Drive mode.

Drive mode	Initial setting
ECO+	2
ECO	2
NORMAL	1
SPORT	1

* For more details, refer to "Drive mode integrated control system" on page 6-76.

One pedal driving

The driver can stop the vehicle by pulling and holding the left side paddle shifter.

Operating Conditions

The system enters the operating condition when the conditions below are met:

- The driver's door is closed.
- The driver's seat belt is fastened.

To operate:

- Pull and hold the left side paddle shifter while coasting.
- When the vehicle speed is above 2 mph (3 km/h), release the paddle shifter to return to the previously set level.
- When the vehicle speed is below 2 mph (3 km/h), the function maintains control to stop the vehicle even though the paddle shifter is released.
- While the One pedal driving is in activation, the driver can control the vehicle stopping position using the accelerator pedal.

Automatic engagement of EPB

After the vehicle is stopped by the One Pedal Driving function, EPB is automatically engaged when any of these conditions occur:

- The driver's door is open.
- The driver's seatbelt is unfastened.
- The hood is open.
- The liftgate is open.
- 5 minutes have passed after the vehicle has stopped.
- The system operation is limited due to other reasons.

WARNING

Do not solely rely on one pedal driving to stop the vehicle. Stopping the vehicle may not be possible depending on vehicle and road conditions. Pay attention to the road condition ahead and apply the brake if necessary.

Smart regeneration system (If equipped with smart cruise control)

The Smart Regeneration System controls the regenerative braking automatically according to the road gradient and driving condition of the vehicle in front.

The system minimizes the unnecessary operation of the brake and acceleration pedal, improving the electric efficiency and assisting the driver.

Setting Smart Regeneration System

1. Place the gear in P (Park).
2. Select 'User settings → Convenience → Smart Regeneration' on the User Settings mode.

The setting is maintained when the vehicle is restarted.

Also, with the Smart Regeneration System activated, pull and hold the right side paddle shifter for over 1 second to turn on and off the automatic change of the regenerative braking.

Smart Regeneration System Activation

With 'AUTO' for the regenerative braking level displayed on the cluster, the regenerative braking level is controlled automatically when vehi-

cle speed is above 6 mph (10 km/h) and one of the condition below is met.

- The road gradient changes
- Distance from the vehicle ahead reduces or increases
- Speed of the vehicle ahead reduces or increases

⚠ WARNING

When vehicle speed is under 6 mph (10 km/h), the Smart Regeneration System is cancelled. The driver must adjust the vehicle speed by depressing the accelerator or brake pedal according to the road condition ahead and driving condition.

When the system is turned on from the User Settings mode, but the front radar doesn't recognize the vehicle in front, 'AUTO' is displayed in white.

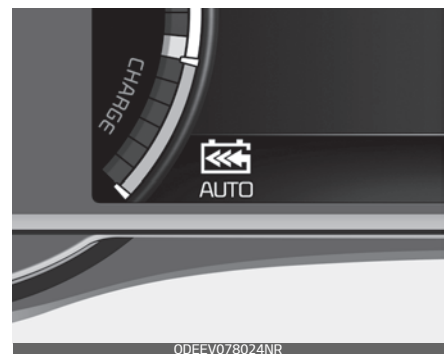

If the front radar recognizes the vehicle in front, 'AUTO' is displayed in blue. The regenerative braking level is automatically controlled depending on the driving condition of the vehicle in front and the level is indicated with arrows.



0DEEV078025NR

However, current regenerative braking level is maintained if the driver depresses the brake pedal while the system is in activation. Also, the system is cancelled temporarily if the accelerator pedal is depressed.

⚠ WARNING

The Smart Regeneration System which automatically controls the regenerative braking level when coasting is only a supplemental system for the driver's convenience. Do not solely rely on this system to stop the vehicle. The system cannot completely stop the vehicle in all situations nor avoid all collisions. The brake control may be insufficient depending on the speed of the vehicle in front and when the vehicle in front suddenly stops, a vehicle cuts in suddenly and there is a steep slope. Always look ahead cautiously to prevent unexpected and sudden situations from occurring.

Smart Regeneration System Will Be Temporarily cancelled When:

- Cancelled manually
Pulling and holding the right side paddle shifter for more than 1 second.
The Smart Regeneration System turns off temporarily and AUTO for the regenerative braking level disappears from the cluster.
- Cancelled automatically
 - The vehicle is shifted to N (Neutral), R (Reverse) or P (Park).
 - The Cruise Control System (including the Smart Cruise Control system) is in activation.

- The ESC (Electronic Stability Control) or ABS is operating.

⚠ WARNING

When the Smart Regeneration System is cancelled automatically, adjust the vehicle speed directly by depressing the accelerator or brake pedal according to the road and driving conditions ahead.

Resuming Smart Regeneration System

To re-activate the Smart Regeneration System while driving:

- Pull and hold the right side paddle shifter for more than 1 second again. Then, AUTO for the regenerative braking level will appear on the cluster.

Turning Smart Regeneration system off

To turn off the system:

- Shift to P (Park) and deselect 'User Settings → Convenience → Smart Regeneration' on the User Settings mode.

Vehicle-to-Vehicle Distance Recognition Sensor (Front Radar)

In order for the Smart Regeneration System to operate properly, always make sure the radar sensor cover is clean and free of dirt, snow, and debris.

Dirt, snow, or foreign substances on the lens may adversely affect the sensing performance of the sensor. In this case, the system operation may stop temporarily and not operate normally.



ODEEV078051NR

⚠ CAUTION

- Do not apply license plate frame or foreign objects such as a bumper sticker or a bumper guard near the radar sensor. Doing so may adversely affect the sensing performance of the radar.
- Always keep the radar sensor and lens cover clean and free of dirt and debris.
- Use only a soft cloth to wash the vehicle. Do not spray pressurized water directly on the sensor or sensor cover.
- Be careful not to apply unnecessary force on the radar sensor or sensor cover. If the sensor is forcibly moved out of proper alignment, the Smart Regeneration System may not operate correctly. In this case, a warning message may not be displayed. Have the vehicle inspected by an authorized Kia dealer.
- If the front bumper becomes damaged in the area around the radar sensor, the Smart Regeneration System may not operate properly. Have the vehicle inspected by an authorized Kia dealer.
- Use only genuine Kia parts to repair or replace a damaged sensor or sensor cover. Do not apply paint to the sensor cover.

System Malfunction

"Check Smart Regeneration System" message will appear when the Smart Regeneration System is not functioning normally.

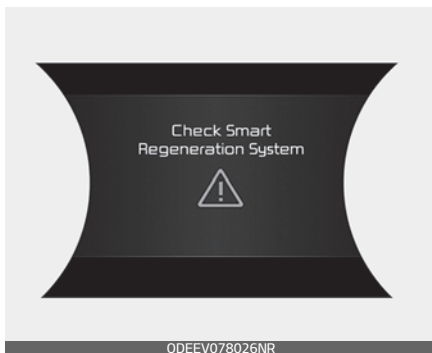

The message will appear when the system is not functioning normally. The system will be cancelled and the word 'AUTO' on the cluster will disappear and instead display regenerative braking level. Check for foreign substances on the front radar. Remove any dirt, snow, or foreign material that could interfere with the radar sensors. If the system still does not operate normally, take your vehicle to an authorized Kia dealer and have the system checked.

Limitations of the System

The Smart Regeneration System may not operate properly in certain situations when the driving condition is beyond the performance of the front radar sensor.

Driver's attention is required in such cases when the system does not react properly or operate unintentionally.

Driving on a curve



ODEEV078027NR

When driving on the curve, the system may not detect the vehicle in your lane and the regenerative braking level will reduce automatically, making you feel that the vehicle is accelerating.

Also, if the system suddenly recognizes the vehicle in front, the regenerative braking level will increase automatically, making you feel that the vehicle is decelerating.

The driver must maintain a safe braking distance, and if necessary, depress the brake pedal to reduce your driving speed in order to maintain a safe distance.



ODEEV078028NR

The smart regeneration system may recognize a vehicle in an adjacent lane when driving on a curved road. In this case, the system increase the braking level and slow the vehicle.

Always pay attention to road and driving conditions while driving. If necessary, depress the brake pedal to reduce your driving speed in order to maintain a safe distance. Also, when necessary, you may depress the accelerator pedal to prevent the system from unnecessarily decelerating your vehicle.

Always check the traffic conditions around the vehicle.

Driving on a slope

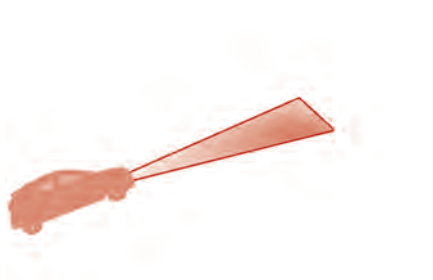

ODEEV078029NR

When driving uphill or downhill, the system may not detect the vehicle in your lane and the regenerative braking level will reduce automatically, making you feel that the vehicle is accelerating.

Also, if the system suddenly recognizes the vehicle in front, the regenerative braking level will increase automatically, making you feel that the vehicle is decelerating.

The driver must maintain a safe braking distance, and if necessary, depress the brake pedal to reduce your driving speed in order to maintain a safe distance.

Changing lanes

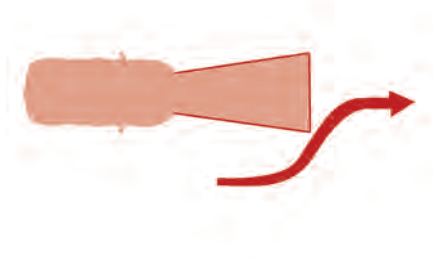

ODEEV078030NR

When a vehicle changes lanes in front of you, the smart regeneration system may not immediately detect the vehicle, especially if the vehicle changes lanes abruptly. In this case, you must maintain a safe braking distance, and if necessary, depress the brake pedal to reduce your driving speed in order to maintain a safe distance.

Recognizing the vehicle



ODEEV078031NR

Some vehicles in your lane cannot be recognized by the sensor:

- Narrow vehicles such as motorcycles or bicycles
- Vehicles offset to one side
- Slow-moving vehicles or sudden-decelerating vehicles
- Stopped vehicles (When the vehicle ahead drives away, the system may not detect a stopped vehicle.)
- Vehicles with small rear profile such as trailers with no loads

A vehicle ahead cannot be recognized correctly by the sensor if any of following occurs:

- When the vehicle is pointing upwards due to overloading in the luggage compartment
- While the steering wheel is operating
- When driving to one side of the lane
- When driving on narrow lanes or on curves

Apply the brake or accelerator pedal if necessary.

⚠ WARNING

When using the Smart Regeneration System take the following precautions:

- If an emergency stop is necessary, you must apply the brakes.
- Keep a safe distance according to road conditions and vehicle speed. If the vehicle to vehicle distance is too close during a high-speed driving, a serious collision may result.
- Always maintain sufficient braking distance and decelerate your vehicle by applying the brakes if necessary.
- The Smart Regeneration System is designed to detect and monitor the vehicle ahead in the roadway through radar signals. It is not designed to detect oncoming vehicles, pedestrians, bicycles, motorcycles, or smaller wheeled objects such as luggage bags, shopping carts, or strollers.
- Vehicles moving in front of you with a frequent lane change may cause a delay in the system's reaction or may cause the system to react to a vehicle actually in an adjacent lane. Always drive cautiously to prevent unexpected and sudden situations from occurring.
- The Smart Regeneration System may not recognize complex driving situations so always pay attention to driving conditions and control your vehicle speed.

*** NOTICE**

The Smart Regeneration System may not operate temporarily due to:

- Electrical interference
 - Modifying the suspension
 - Differences of tire abrasion or tire pressure
 - Installing different type of tires
-

This device complies with Part 15 of the FCC rules.

Operation is subject to the following three conditions:

1. This device may not cause harmful interference, and
2. This device must accept any interference received, including interference that may cause undesired operation.
3. Changes or modifications not expressly approved by the party responsible for compliance could void the user's authority to operate the device.

Radio frequency radiation exposure information:

This equipment complies with FCC radiation exposure limits set forth for an uncontrolled environment.

This equipment should be installed and operated with minimum distance of 8 in (20 cm) between the radiator (antenna) and your body.

This transmitter must not be collocated or operating in conjunction with any other antenna or transmitter.

Brake system

This vehicle is equipped with various brakes and functions to stop the vehicle or keep it stationary.

Power brakes

Your vehicle has power-assisted brakes that adjust automatically through normal usage.

If the vehicle is not on or is turned off while driving, the power assist for the brakes will not work. You can still stop your vehicle by applying greater force to the brake pedal than typical. The stopping distance, however, will be longer than with power brakes.

When the vehicle is not on, the reserve brake power is partially depleted each time the brake pedal is applied. Do not pump the brake pedal when the power assist has been interrupted.

Pump the brake pedal only when necessary to maintain steering control on slippery surfaces.

CAUTION

Brake Pedal

Do not drive with your foot resting on the brake pedal. This will create abnormally high brake temperatures which can cause excessive brake lining and pad wear.

WARNING

Steep hill braking

Avoid continuous application of the brakes when descending a long or steep hill by shifting to a lower gear. Continuous brake application will cause the brakes to overheat and could result in a temporary loss of braking performance.

Wet brakes may impair the vehicle's ability to safely slow down; the vehicle may also pull to one side when the brakes are applied. Applying the brakes lightly will indicate whether they have been affected in this way. Always test your brakes in this fashion after driving through deep water. To dry the brakes, apply them lightly while maintaining a safe forward speed until brake performance returns to normal.

CAUTION

Do not depress the brake pedal continuously without the "" indicator ON. The battery may be discharged.

In the event of brake failure

If service brakes fail to operate while the vehicle is in motion, you can make an emergency stop with the parking brake. The stopping distance, however, will be much greater than normal.

⚠ WARNING

Parking brake

Avoid applying the parking brake to stop the vehicle while it is moving except in an emergency situation. Applying the parking brake while the vehicle is moving at normal speeds can cause a sudden loss of control of the vehicle. If you must use the parking brake to stop the vehicle, use great caution in applying the brake.

Disc brakes wear indicator

When your brake pads are worn and new pads are required, you will hear a high-pitched warning sound from your front brakes or rear brakes. You may hear this sound come and go or it may occur whenever you depress the brake pedal.

Please remember that some driving conditions or climates may cause a brake squeal when you first apply (or lightly apply) the brakes. This is normal and does not indicate a problem with your brakes.

Always replace the front or rear brake pads as pairs.

⚠ CAUTION

Replace brake pads

Do not continue to drive with worn brake pads. Continuing to drive with worn brake pads can damage the braking system and result in costly brake repairs.

⚠ WARNING

Brake wear

Do not ignore high pitched wear sounds from your brakes. If you ignore this audible warning, you will eventually lose braking performance, which could lead to a serious accident.

Electronic parking brake (EPB)

The electronic parking brake switch is located on the lower left side of the shifter dial.

Applying the parking brake



ODEEV078032NR

1. Depress the brake pedal.
2. Pull up the EPB switch.

Make sure the warning light comes on.

Also, the EPB is applied automatically if the Auto Hold button is on when the vehicle is turned off. However, if you pull up the EPB switch after the vehicle is turned off, the EPB will not be Applied.

* NOTICE

On a steep incline or when pulling a trailer, if the vehicle does not remain at a standstill, do as follows:

1. Apply the EPB.
2. Pull up the EPB switch for more than 3 seconds.

Do not operate the parking brake / EPB while the vehicle is moving except in an emergency situation.

* NOTICE

A click or electric brake motor whine sound may be heard while operating or releasing the EPB.

These conditions are normal and indicate that the EPB is functioning properly.

Releasing the parking brake with Electronic parking brake (EPB) switch



ODEEV078033NR

1. Releasing the parking brake with EPB switch,
 - Have the POWER button in the ON position.
 - Depress the brake pedal.
 - The shifter dial must be in P (Park).
2. Make sure the brake warning light goes off.

Automatic release of Electronic parking brake (EPB)

The EPB is released automatically under following conditions.

- Shifter dial in P (Park)
With the vehicle running depress the brake pedal and shift out of P (Park) to R (Reverse) or D (Drive).
- Shifter dial in N (Neutral)
With the vehicle running depress the brake pedal and shift out of N (Neutral) to R (Reverse) or D (Drive).
- Reduction gear
 1. Start the vehicle.
 2. Fasten the driver's seat belt.
 3. Close the driver's door, hood and trunk (liftgate).
 4. Depress the accelerator pedal while the shifter dial is in R (Rear), D (Drive).

Make sure the brake warning light goes off.

* NOTICE

- For your safety, you can engage the EPB even though the POWER button is in the OFF position, but you cannot release it.
- For your safety, depress the brake pedal and release the parking brake manually with the EPB switch when you drive downhill or when backing up the vehicle.

Do not follow the above procedure when driving on a flat level ground. The vehicle may suddenly move forward.

* NOTICE

If the parking brake warning light is still on even though the EPB has been released, have the system checked by an authorized Kia dealer.

⚠ CAUTION

Do not drive your vehicle with the EPB applied. It may cause excessive brake pad and brake rotor wear.

(EPB) may be automatically applied when:

- The EPB is overheated
- Requested by other systems

* NOTICE

For EPB (Electronic Parking Brake) equipped vehicles with AUTO HOLD function used while driving, if the POWER button has been turned OFF, the EPB will be engaged automatically. Therefore, AUTO HOLD function should be turned off before the POWER button is turned off.

System warning

The EPB will display a warning message with sound under certain conditions.

- If you try to drive off depressing the accelerator pedal with the EPB applied, but the EPB doesn't release automatically, a warning will sound and a message will appear.
- If the driver's seat belt is not fastened and the vehicle hood, driver's door or trunk is opened, a warning will sound and a message will appear.



- If there is a problem with the vehicle, a warning may sound and a message may appear.

If the above situation occurs, depress the brake pedal and release EPB by pressing the EPB switch.

⚠ WARNING

Parking Brake Use

- Never allow a passenger to touch the parking brake. If the parking brake is released unintentionally, serious injury may occur.
 - All vehicles should always have the parking brake fully engaged when parked to avoid inadvertent movement of the vehicles which can injure occupants or pedestrians.
-
- A click or electric brake motor whine sound may be heard while operating or releasing the EPB. These conditions are normal and indicate that the EPB is functioning properly.
 - When leaving your keys with a parking lot attendant or valet, make sure to inform him/her how to operate the EPB.
 - The EPB may malfunction if you drive with the EPB applied.
 - When you automatically release EPB by depressing the accelerator pedal, depress it slowly.

When the conversion from Auto Hold to EPB is not working properly a warning will sound and a message will appear.

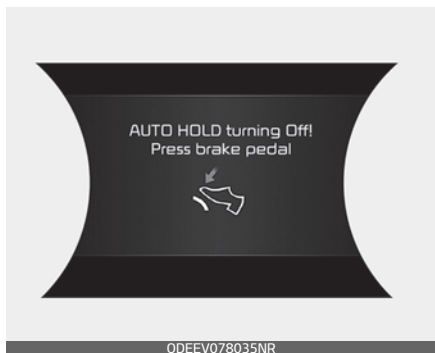

*** NOTICE**

Depress the brake pedal when the above message appears for the Auto Hold and EPB may not activate.

If the EPB is applied while Auto Hold is activated because of an ESC (Electronic Stability Control) signal, a warning will sound and a message will appear.

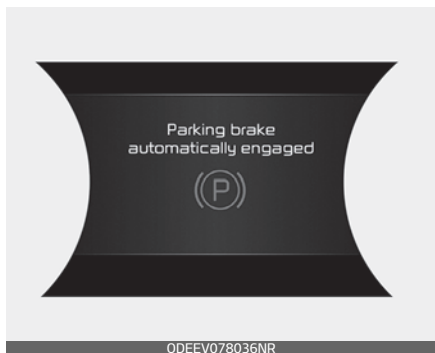

Electronic parking brake (EPB) malfunction indicator (if equipped)

This warning light illuminates if the POWER button is changed to the ON position and goes off in approximately 3 seconds if the system is operating normally.



ODEEV078037NR

If the EPB malfunction indicator remains on, comes on while driving, or does not come on when the POWER button is changed to the ON position, this indicates that the EPB may have malfunctioned.

If this occurs, have your vehicle checked by an authorized Kia dealer as soon as possible.

The EPB malfunction indicator may illuminate when the ESC indicator comes on to indicate that the ESC is not working properly, but it does not indicate a malfunction of the EPB.

The EPB warning light may illuminate if the EPB switch operates abnormally. Shut the vehicle off and turn it on again after a few minutes.

The warning light will go off and the EPB switch will operate normally. However, if the EPB warning light is still on, have the system checked by an authorized Kia dealer.

If the parking brake warning light does not illuminate or blinks even though the EPB switch was pulled up, the EPB is not applied.

If the parking brake warning light blinks when the EPB warning light is on, press the EPB switch, then pull it up. Once more press it back to its original position and pull it back up. If the EPB warning does not go off, have the system checked by an authorized Kia dealer.

Emergency braking

If there is a problem with the brake pedal while driving, emergency braking is possible by pulling up and holding the EPB switch.

Braking is possible only while you are holding the EPB switch.

⚠ WARNING

Do not operate the electronic parking brake while the vehicle is moving except in an emergency situation. Applying the electronic parking brake while the vehicle is moving at normal speeds can cause a sudden loss of control of the vehicle. If you must use the electronic parking brake to stop the vehicle, use great caution in applying the brake.

*** NOTICE**

During emergency braking by the EPB, the parking brake warning light will illuminate to indicate that the system is operating.

If you notice a continuous noise or burning smell when the EPB is used for emergency braking, have your vehicle checked by an authorized Kia dealer.

When the EPB (electronic parking brake) is not released

If the EPB does not release normally, take your vehicle to an authorized Kia dealer by loading the vehicle on a flatbed tow truck and have the system checked.

AUTO HOLD (if equipped)

The Auto Hold maintains the vehicle in a standstill even though the brake pedal is not depressed after the driver brings the vehicle to a complete stop by depressing the brake pedal.

Applying Auto Hold function

1. Depress the brake pedal, start the vehicle and then press the Auto Hold button. The white AUTO HOLD indicator will come on indicating the system is in standby.



ODEEV078038NR

Before the Auto Hold will engage, the driver's door and vehicle hood must be closed and the liftgate must be closed.

When coming to a complete stop by depressing the brake pedal, the AUTO HOLD indicator changes from white to green indicating the AUTO HOLD is engaged. The vehicle will remain at a standstill even if you release the brake pedal.



ODEEV078039NR

If EPB is applied, Auto Hold will be released.

If you press the accelerator pedal with the shifter dial in D (Drive) or manual mode, the Auto Hold will be released automatically and the vehicle will start to move. The indicator changes from green to white indicating the Auto Hold is in standby and the EPB is released.

When driving off from Auto Hold by depressing the accelerator pedal, always check the surrounding area near your vehicle.

Slowly depress the accelerator pedal for a smooth launch.

Canceling Auto Hold function



ODEEV078040NR

- To cancel the Auto Hold operation, press the Auto Hold switch. The AUTO HOLD indicator will go out.
- To cancel the Auto Hold operation when the vehicle is at a standstill, press the Auto Hold switch while depressing the brake pedal.

* NOTICE

- The following are conditions when the Auto Hold will not engage (Auto Hold light will not turn green and the Auto Hold system remains in stand by):
 - The driver's door is opened
 - The vehicle hood or liftgate is opened
 - The shifter dial is in P (Park)
 - The EPB is applied
- For your safety, the Auto Hold automatically switches to EPB under any of the following conditions (Auto Hold light remains white and the EPB automatically applies):
 - The driver's door is opened
 - The vehicle hood or liftgate is opened
 - The vehicle is in a standstill for more than 10 minutes
 - The vehicle is standing on a steep slope
 - The vehicle moved for a few seconds

In these cases, the brake warning light comes on, the AUTO HOLD indicator changes from green to white, and a warning sounds and a message will appear to inform you that EPB has been automatically engaged. Before driving off again, press foot brake pedal, check the surrounding area near your vehicle and release

parking brake manually with the EPB switch.

- If the AUTO HOLD indicator lights up yellow, the Auto Hold is not working properly. Take your vehicle to an authorized Kia dealer and have the system checked.

⚠ WARNING

To reduce the risk of an accident, do not activate Auto Hold while driving downhill, backing up or parking your vehicle.

If there is a malfunction with the driver's door or vehicle hood or liftgate open detection system, the Auto Hold may not work properly.

Take your vehicle to an authorized Kia dealer and have the system checked.

* NOTICE

A click or electric brake motor whine sound may be heard while operating or releasing the EPB, but these conditions are normal and indicate that the EPB is functioning properly.

Warning messages

The Auto Hold function will display a warning message with sound under certain conditions.

When the EPB is applied from Auto Hold, a warning will sound and a message will appear.

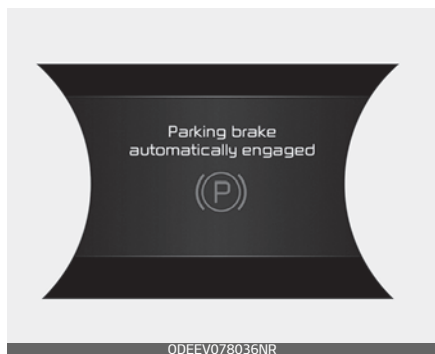

When the conversion from Auto Hold to EPB is not working properly a warning will sound and a message will appear.

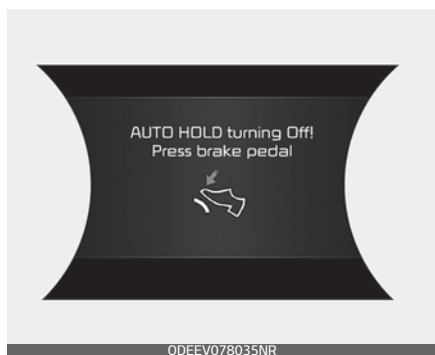

* NOTICE

When this message is displayed, the Auto Hold and EPB may not operate. For your safety, depress the brake pedal.

If you do not apply the brake pedal when you release the Auto Hold by pressing the [AUTO HOLD] switch, a warning will sound and a message will appear.

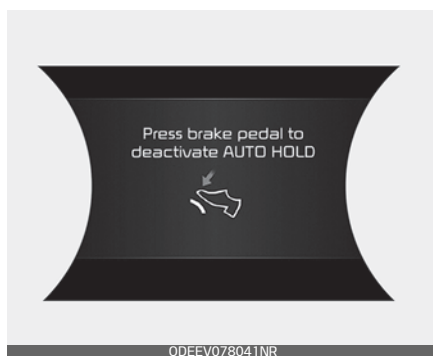

When you press the [AUTO HOLD] switch, if the driver's door and vehicle hood are not closed or the lift-gate is not closed, a warning will sound and a message will appear on the LCD display.

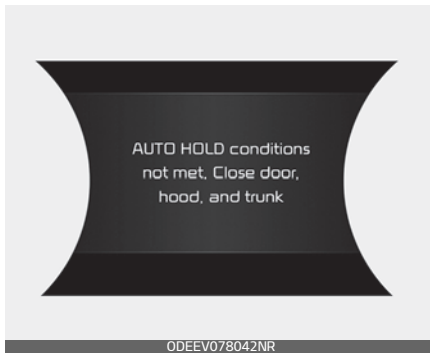

At this moment, press the [AUTO HOLD] button after closing the driver's door, vehicle hood and lift-gate.

WARNING

Parking brake use

- Never allow a passenger to touch the parking brake. If the parking brake is released unintentionally, serious injury may occur.
- All vehicles should always have the parking brake fully engaged when parked to avoid inadvertent movement of the vehicles which can injure occupants or pedestrians.

Check the brake warning light by pressing POWER button ON (do not start the vehicle). This light will be illuminated when the parking brake is applied with the POWER button in the START or ON position.



Before driving, be sure the parking brake is fully released and the brake warning light is off.

If the brake warning light remains on after the parking brake is released while the vehicle is running, there may be a malfunction in the brake system. Immediate attention is necessary.

If at all possible, cease driving the vehicle immediately. If that is not possible, use extreme caution while operating the vehicle and only continue to drive the vehicle until you can reach a safe location or repair shop.

Anti-lock brake system (ABS)

The ABS prevents the wheels from locking. So the vehicle remains stable and can still be steered.

ABS (or ESC) will not prevent accidents due to improper or dangerous driving maneuvers. Even though vehicle control is improved during emergency braking, always maintain a safe distance between you and objects ahead. Vehicle speeds should always be reduced during extreme road conditions. The vehicle should be driven at reduced speeds in the following circumstances:

- When driving on rough, gravel or snow-covered roads
- When driving with tire chains installed
- When driving on roads where the road surface is pitted or has different surface heights.

Driving in these conditions increases the stopping distance for your vehicle.

The ABS continuously senses the speed of the wheels. If the wheels are going to lock, the ABS system repeatedly modulates the hydraulic brake pressure to the wheels.

When you apply your brakes under conditions which may lock the wheels, you may hear a "tik-tik" sound from the brakes, or feel a corresponding sensation in the brake pedal. This is normal and it means your ABS is active.

In order to obtain the maximum benefit from your ABS in an emergency situation, do not attempt to modulate your brake pressure and do not try to pump your brakes. Press your brake pedal as hard as possible to allow the ABS to control the force being delivered to the brakes.

* NOTICE

A click sound may be heard in the vehicle compartment when the vehicle begins to move after the vehicle is started. These conditions are normal and indicate that the anti-lock brake system is functioning properly.

Even with the anti-lock brake system, your vehicle still requires sufficient stopping distance. Always maintain a safe distance from the vehicle in front of you.

Always slow down when cornering. The anti-lock brake system cannot prevent accidents resulting from excessive speeds.

On loose or uneven road surfaces, operation of the anti-lock brake system may result in a longer stopping distance than for vehicles equipped with a conventional brake system.

The ABS warning light will stay on for approximately 3 seconds after the POWER button is ON.



During that time, the ABS will go through self-diagnosis and the light will go off if everything is normal. If the light stays on, you may have a problem with your ABS. Contact an authorized Kia dealer as soon as possible.

When you drive on a road having poor traction, such as an icy road, and have operated your brakes continuously, the ABS will be active continuously and the ABS warning light may illuminate. Pull your vehicle over to a safe place and stop the vehicle.

Restart the vehicle. If the ABS warning light goes off, then your ABS system is normal. Otherwise, you may have a problem with the ABS. Contact an authorized Kia dealer as soon as possible.

* NOTICE

When you jump start your vehicle because of a drained battery, the vehicle may not run as smoothly and the ABS warning light may turn on at the same time. This happens because of low battery voltage. It does not mean your ABS has malfunctioned.

- Do not pump your brakes!
- Have the battery recharged before driving the vehicle.

Electronic stability control (ESC)

The ESC system is designed to stabilize the vehicle during cornering maneuvers.



ODEEV078045NR

ESC checks where you are steering and where the vehicle is actually going. ESC applies the brakes on individual wheels and intervenes with the vehicle management system to stabilize the vehicle.

ESC will not prevent accidents.

Excessive speed in turns, abrupt maneuvers and hydroplaning on wet surfaces can still result in serious accidents.

Only a safe and attentive driver can prevent accidents by avoiding maneuvers that cause the vehicle to lose traction. Even with ESC installed, always follow all the normal precautions for driving – including driving at safe speeds for the conditions.

⚠ WARNING

For maximum protection, always wear your seat belt. No system, no matter how advanced, can compensate for all driver error and/or driving conditions. Always drive responsibly.

The ESC system is an electronic system designed to help the driver maintain vehicle control under adverse conditions. It is not a substitute for safe driving practices. Factors including speed, road conditions and driver steering input can all affect whether ESC will be effective in preventing a loss of control. It is still your responsibility to drive and corner at reasonable speeds and to leave a sufficient margin of safety.

When you apply your brakes under conditions which may lock the wheels, you may hear a "tik-tik" sound from the brakes, or feel a corresponding sensation in the brake pedal. This is normal and it means your ESC is active.

*** NOTICE**

A click sound may be heard in the vehicle compartment when the vehicle begins to move after the vehicle is started. These conditions are normal and indicate that the Electronic Stability Control System is functioning properly.

Electronic stability control (ESC) operation**ESC ON condition**

- When the POWER button is turned ON, ESC and ESC OFF indicator lights illuminate for approximately 3 seconds, then ESC is turned on.
- Press the ESC OFF button for at least half a second after turning the vehicle ON to turn ESC off. (ESC OFF indicator will illuminate). To turn the ESC on, press the ESC OFF button (ESC OFF indicator light will go off).
- When starting the vehicle, you may hear a slight ticking sound. This is the ESC performing an automatic system self-check and does not indicate a problem.

When operating

When the ESC is in operation, the ESC indicator light blinks.

When the Electronic Stability Control is operating properly, you can feel a slight pulsation in the vehicle. This is only the effect of brake control and indicates nothing unusual.

When moving out of the mud or driving on a slippery road, pressing the accelerator pedal may not cause the vehicle rpm (revolutions per minute) to increase.



Electronic stability control (ESC) operation off





This car has 2 kinds of ESC off states.

If the vehicle stops when ESC is off, ESC remains off. Upon restarting the vehicle, the ESC will automatically turn on again.

ESC off state 1 – Traction control disabled

To turn off the traction control function and only operate the brake control function of the ESC, press the ESC OFF button (ESC OFF ) for less than 3 seconds and the ESC OFF indicator light (ESC OFF ) will illuminate.

ESC off state 2 – Traction & stability control disabled

To turn off the traction control function and the brake control function of the ESC, press the ESC OFF button (ESC OFF ) for more than 3 seconds. ESC OFF indicator light (ESC OFF ) will illuminate and ESC OFF warning chime will sound. At this state, the car stability control function does not operate any more.

Indicator light

ESC indicator light



ESC OFF indicator light



When POWER button is turned to ON, the indicator light illuminates, then goes off if the ESC system is operating normally.

The ESC indicator light blinks whenever ESC is operating or illuminates when ESC fails to operate.

The ESC OFF indicator light comes on when the ESC is turned off with the button.

⚠ WARNING

Electronic stability control

Drive carefully even though your vehicle has Electronic Stability Control. It can only assist you in maintaining control under certain circumstances.

ESC OFF usage

When driving

- ESC should be turned on for daily driving whenever possible.
- To turn ESC off while driving, press the ESC OFF button while driving on a flat road surface.

⚠ WARNING**Operating ESC**

Never press the ESC OFF button while ESC is operating (ESC indicator light blinks).

If ESC is turned off while ESC is operating, the vehicle may slip out of control.

*** NOTICE**

- When operating the vehicle on a dynamometer, ensure that the ESC is turned off (ESC OFF light illuminated). If the ESC is left on, it may prevent the vehicle speed from increasing, and result in false diagnosis.
- Turning the ESC off does not affect ABS or brake system operation.

Vehicle stability management (VSM)

This system provides further enhancements to vehicle stability and steering responses when a vehicle is driving on a slippery road or a vehicle detects changes in coefficient of friction between right wheels and left wheels when braking.

⚠ WARNING**Tire/Wheel size**

When replacing tires and wheels, make sure they are the same size as the original tires and wheels installed. Driving with varying tire or wheel sizes may diminish any supplemental safety benefits of the VSM system.

Vehicle stability management (VSM) operation

When the VSM is in operation, ESC indicator light () blinks.

When the vehicle stability management is operating properly, you can feel a slight pulsation in the vehicle and/or abnormal steering responses (EPS- Electronic Power Steering). This is only the effect of brake and EPS control and indicates nothing unusual.

The VSM does not operate when:

- Driving on a sloping road such as a gradient or incline
- Driving in reverse
- ESC OFF indicator light () remains on the instrument cluster
- EPS indicator light remains on the instrument cluster

Vehicle stability management (VSM) operation off

If you press the ESC OFF button to turn off the ESC, the VSM will also cancel and the ESC OFF indicator

light () illuminates.

To turn on the VSM, press the button again. The ESC OFF indicator light goes out.

WARNING

Vehicle stability management

Drive carefully even though your vehicle has vehicle stability management. It can only assist you in maintaining control of the vehicle under certain circumstances.

Malfunction indicator

The VSM can be deactivated even if you don't cancel the VSM operation by pressing the ESC OFF button. It indicates that a malfunction has been detected somewhere in the Electric Power Steering system or VSM system. If the ESC indicator

light () or EPS warning light

remains on, take your vehicle to an authorized Kia dealer and have the system checked.

*** NOTICE**

- The VSM is designed to function above approximately 13 mph (22 km/h) on curves.
- The VSM is designed to function above approximately 6 mph (10 km/h) when a vehicle is braking on a split- μ surface. A split- μ surface is made of two surfaces which have different friction forces.

The Vehicle Stability Management system is not a substitute for safe driving practices but a supplementary function only. It is the responsibility of the driver to always check the speed and the distance to the vehicle ahead. Always hold the steering wheel firmly while driving.

Your vehicle is designed to activate according to the driver's intention, even with installed VSM. Always follow all the normal precautions for driving at safe speeds for the conditions – including driving in clement weather and on a slippery road.

WARNING

For maximum protection, always wear your seat belt. No system, no matter how advanced, can compensate for all driver error and/or driving conditions. Always drive responsibly.

Hill-start Assist Control (HAC)

A vehicle has the tendency to roll back on a steep hill when it starts to go after stopping. The Hill-start Assist Control (HAC) prevents the vehicle from rolling back by applying the brakes automatically for about 2 seconds.

The brakes are released when the accelerator pedal is depressed or after about 2 seconds.

The HAC is activated only for about 2 seconds, so when the vehicle is starting off always depress the accelerator pedal.

WARNING

Maintaining Brake Pressure on Incline

HAC does not replace the need to apply brakes while stopped on an incline. While stopped, make sure you maintain brake pressure sufficient to prevent your vehicle from rolling backward and causing an accident. Don't release the brake pedal until you are ready to accelerate forward.

Good braking practices

Good braking practices help to drive safely and extend brake life.

- Check to be sure the parking brake is not engaged and the parking brake indicator light is out before driving away.
- Driving through water may get the brakes wet. They can also get wet when the vehicle is washed. Wet brakes can be dangerous! Your vehicle will not stop as quickly if the brakes are wet. Wet brakes may cause the vehicle to pull to one side. To dry the brakes, apply the brakes lightly until the braking action returns to normal, taking care to keep the vehicle under control at all times. If the braking action does not return to normal, stop as soon as it is safe to do so and call an authorized Kia dealer for assistance.
- Don't coast down hills with the vehicle out of gear. This is extremely hazardous. Keep the vehicle in gear at all times, use the brakes to slow down, then shift to a lower gear so that vehicle braking will help you maintain a safe speed.
- Don't "ride" the brake pedal. Resting your foot on the brake pedal while driving can be dangerous because the brakes might overheat and lose their effectiveness. It also increases the wear of the brake components.
- If a tire goes flat while you are driving, apply the brakes gently and keep the vehicle pointed straight ahead while you slow down. When you are moving slowly enough for it to be safe to do so, pull off the road and stop in a safe place.

- Be cautious when parking on a hill. Firmly engage the parking brake and place the shifter dial in P. If your vehicle is facing downhill, turn the front wheels into the curb to help keep the vehicle from rolling. If your vehicle is facing uphill, turn the front wheels away from the curb to help keep the vehicle from rolling. If there is no curb or if it is required by other conditions to keep the vehicle from rolling, block the wheels.
- Under some conditions your parking brake can freeze in the engaged position. This is most likely to happen when there is an accumulation of snow or ice around or near the rear brakes or if the brakes are wet. If there is a risk that the parking brake may freeze, apply it only temporarily while you put the shifter dial in P and block the rear wheels so the vehicle cannot roll. Then release the parking brake.
- Do not hold the vehicle on an incline with the accelerator pedal. This can cause the reduction gear to overheat. Always use the brake pedal or parking brake.

Forward Collision–Avoidance Assist (FCA) (Smart Cruise Control System Equipped) (if equipped)

The FCA system is designed to detect and monitor a vehicle ahead or detect a pedestrian in the roadway through radar signals and camera recognition to warn the driver that a collision is imminent, and if necessary, apply emergency braking.

WARNING

Forward Collision–Avoidance assist (FCA) Limitations

The FCA system is a supplemental system and is not a substitute for safe driving practices.

It is the responsibility of the driver to always check the speed and distance to the vehicle ahead and to be prepared to apply the brakes.

⚠ WARNING

Take the following precautions when using the forward collision-avoidance assist (FCA) system:

- This system is only a supplemental system and it is not intended to, or does it replace the need for extreme care and attention of the driver. The sensing range and objects detectable by the sensors are limited. Pay attention to the road conditions at all times.
- NEVER drive too fast in accordance with the road conditions or while cornering.
- Always drive cautiously to prevent unexpected and sudden situations from occurring. FCA does not stop the vehicle completely and does not avoid all collisions due to system limitations.

Setting and activating the FCA

The driver can activate the FCA by placing the POWER button to the ON position and by selecting:

- Go to the 'User Settings → Driver Assistance → Forward collision-avoidance assist' on the LCD display.

The FCA deactivates, when the driver cancels the system setting.



The warning light illuminates on the LCD display, when you cancel the FCA

system. The driver can monitor the FCA ON/OFF status on the LCD display. Also, the warning light illuminates when the ESC (Electronic Stability Control) is turned off (Traction & Stability control disabled.).

When the warning light remains ON with the FCA activated, take your vehicle to an authorized Kia dealer and have the system checked.

Setting the initial warning activation time

The driver can select the initial warning activation time in the User Settings in the instrument cluster LCD display.

The options for the initial Forward Collision Warning include the following:

- EARLY: When this condition is selected, the initial Forward Collision Warning is activated earlier than normal. This setting maximizes the amount of distance between the vehicle or pedestrian ahead before the initial warning occurs. If the 'EARLY' condition feels too sensitive, change it into 'NORMAL'.
- NORMAL: When this condition is selected, the initial Forward Collision Warning is activated normally.
- LATE: When this condition is selected, the initial Forward Colli-

sion Warning is activated later than normal. This setting reduces the amount of distance between the vehicle or pedestrian ahead before the initial warning occurs. Select this condition only when traffic is light, and you are driving slowly.

Prerequisite for the FCA activation

The FCA will activate when the FCA is selected on the LCD display, and when the following prerequisites are satisfied:

- The ESC (Electronic Stability Control) is activated.
- The driving speed is over 6 mph (10 km/h). (The FCA only works within a certain range of vehicle speeds)
- When the FCA recognizes a vehicle or the pedestrian in front.

WARNING

The FCA may not recognize every obstacle or provide warnings and braking in every situation, so do not rely on the FCA to stop the vehicle in instances where the driver sees an obstacle and has the ability to apply the brakes.

- The FCA automatically activates upon placing the POWER button to the ON position. The driver can deactivate the FCA by canceling the system setting on the LCD display.
- The FCA automatically deactivates upon canceling the ESC. When the ESC is canceled, the FCA cannot be activated on the LCD display. The FCA warning light will illuminate.
- To avoid driver distractions, do not attempt to set or cancel the FCA while operating the vehicle.

FCA warning message and brake control

The FCA system produces warning messages, warning alarms, and emergency braking based on the level of risk of a frontal collision, such as when a vehicle ahead suddenly brakes, or when the system detects that a collision with a pedestrian is imminent.

The driver can select the initial warning activation time in the User Settings in the LCD display. The options for the initial Forward Collision Warning include Early, Normal or Late initial warning time.

Collision Warning (1st warning)



- The warning message appears on the LCD display with the warning alarms.
- The FCA limitedly controls the brakes within certain limit to reduce the impact from the collision.

Emergency braking (2nd warning)

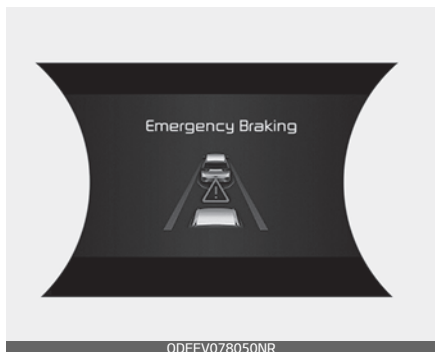

- The warning message appears on the LCD display with the warning alarms.
- The FCA limitedly controls the brakes within certain limit to

reduce the impact from the collision.

The brake control is maximized just before the collision.

Brake operation

In an urgent situation, the braking system enters into the ready status for prompt reaction to assist the driver in depressing the brake pedal.

- The FCA system provides additional braking power for optimum braking performance when the driver depresses the brake pedal.
- The braking control is automatically deactivated when the driver sharply depresses the accelerator pedal, or when the driver abruptly operates the steering wheel.
- The braking control is automatically canceled when risk factors disappear.

The driver should always exercise caution when operating the vehicle, even though there is no warning message or warning alarm.

⚠ WARNING

The FCA cannot avoid all collisions. The FCA might not completely stop the vehicle before collision, due to driving or road conditions. The driver has the responsibility to drive safely and control the vehicle.

⚠ WARNING

The FCA is a supplemental system and cannot completely stop the vehicle in all situations or avoid all collisions. It is the responsibility of the driver to safely drive and control the vehicle.

⚠ WARNING

Never deliberately drive dangerously to activate the system as such conduct increases the risk of an accident.

*** NOTICE**

The FCA system assesses the risk of a collision by monitoring several variables such as the distance to the vehicle/pedestrian ahead, the speed of the vehicle/pedestrian ahead, and the driver's operation of the vehicle. Certain conditions such as inclement weather and road conditions may affect the operation of the FCA system.

For the system operation, do not attempt risky driving.

FCA front radar / Camera sensor

In order for the FCA system to operate properly, always make sure the sensor or sensor cover is clean and free of dirt, snow, and debris. Dirt, snow, or foreign substances on the sensor or its external parts may adversely affect the sensing performance of the sensor.



*** NOTICE**

- Do not apply foreign objects such as a bumper sticker or a bumper guard near the radar sensor. Doing so may adversely affect the sensing performance of the radar.
- Always keep the radar sensor and over clean and free of dirt and debris.
- Use only soft clothes to wash the vehicle. Do not spray pressurized water directly on the sensor or sensor cover.
- Be careful not to apply unnecessary force on the radar sensor or sensor cover. If the sensor is forcibly moved out of proper alignment, the FCA system may not operate correctly. In this case, a warning message may not be displayed. Have the vehicle inspected by an authorized Kia dealer.
- If the front bumper becomes damaged in the area around the radar sensor, the FCA system may not operate properly. In this case, have your vehicle inspected by an authorized Kia dealer.
- Use only genuine parts to repair or replace a damaged sensor or sensor cover. Do not apply paint to the sensor cover.
- Do not tint the window or install stickers or accessories around the inside mirror where the camera is installed.

Forward Collision-Avoidance Assist (FCA) (Smart Cruise Control System Equipped)

- Make sure the frontal camera installation point does not get wet.
- Do not impact or remove any radar/camera components.
- Do not place reflective objects (white paper or mirror etc.) on the dashboard. The system may activate unnecessarily due to reflection of the sunlight.
- Excessive audio system volume may prevent occupants from hearing the FCA system warning alarm.

Warning message and warning light

When the sensor is covered or the sensor lens is dirty with foreign substances, such as snow or rain, the FCA system may not be able to detect vehicles or pedestrians.

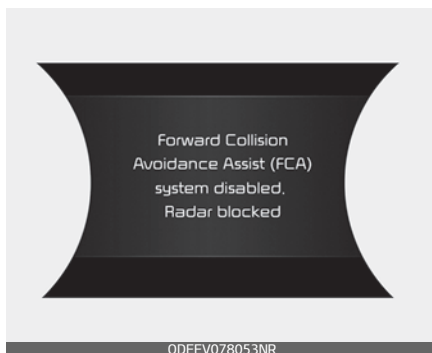

In this case, a warning message ("Forward Collision Avoidance Assist (FCA) system disabled. Radar blocked") will appear to notify the

Driving your vehicle

driver. Remove the foreign substances to allow the FCA system to function normally.

Remove any dirt, snow, or debris and clean the radar sensor cover before operating the FCA system.

The FCA may not properly operate in an area (e.g. open terrain), where any vehicles or objects are not detected after turning ON the vehicle.

FCA malfunction

When the FCA is not working properly, the FCA warning light (🚗⚠️) will illuminate and the warning message will appear for a few seconds.



After the message disappears, the master warning light (⚠️) will illuminate. In this case, take your vehicle to an authorized Kia dealer and have the system checked.

Forward Collision-Avoidance Assist (FCA) (Smart Cruise Control System Equipped)

The FCA system will also be deactivated for the sake of driver's safety when the ESC warning light comes on. The FCA warning message will appear at the same time, too. But that doesn't necessarily mean the malfunction of the FCA system.

Both FCA warning light and warning message will disappear once the ESC warning light issue is resolved.

⚠️ WARNING

- The FCA is only a supplemental system for the driver's convenience. It is the driver's responsibility to control the vehicle operation. Do not solely depend on the FCA system. Rather, maintain a safe braking distance, and, if necessary, depress the brake pedal to reduce the driving speed or stop the vehicle.
- In certain instances and under certain driving conditions, the FCA system may activate unintentionally. This initial warning message appears on the LCD display with a warning chime. Also, due to sensing limitations, in certain situations, the front radar sensor or camera recognition system may not detect the vehicle, pedestrian or cyclist (if equipped) ahead. The FCA system may not activate and the warning message will not be displayed.
- The FCA may unnecessarily produce the warning message and

the warning alarms. Also, due to the sensing limitation, the FCA may not produce the warning message and the warning alarm at all.

- When there is a malfunction with the FCA, the autonomous emergency braking does not operate upon detecting a collision risk even with other braking systems normally operating.
- The FCA operates only for the vehicle/pedestrian in front, while driving forward. It does not operate for any animals or vehicles in the opposite direction.
- The FCA does not recognize the vehicle, which horizontally drives across the crossroad, or the vehicle, which is parked in the horizontal direction.
- If the vehicle in front stops suddenly, you may have less control of the brake system. Therefore, always keep a safe distance between your vehicle and the vehicle in front of you.
- The FCA system may activate during braking and the vehicle may stop suddenly. And the load in the vehicle may endanger passengers. Therefore, always be mindful of the load volume in the vehicle.
- The FCA system may not activate if the driver applies the brake pedal to avoid risk of collision.
- If there is a malfunction with the FCA system, the autonomous

emergency braking is not applied even though the braking system is operating normally.

- The FCA system does not operate when the vehicle is in reverse.
 - The FCA system is not designed to detect other objects on the road such as animals.
 - The FCA system does not detect vehicles in the opposite lane.
 - The FCA system does not detect cross traffic vehicles that are approaching.
 - The FCA system cannot detect the driver approaching the side view of a parked vehicle (for example on a dead end street). In these cases, you must maintain a safe braking distance, and if necessary, depress the brake pedal to reduce the driving speed in order to maintain a safe distance.
 - The regular braking function will operate normally even if there is a problem with the FCA brake control system or other functions. In this case, the autonomous braking will not operate in the risk of a collision.
 - The FCA system may not activate depending on road or driving conditions.
 - The FCA system may not activate to all types of vehicles.
-

Limitations of the FCA

The FCA system is designed to monitor the vehicle ahead in the roadway through radar signals and camera recognition to warn the driver that a collision is imminent, and if necessary, apply emergency braking.

In certain situations, the radar sensor or the camera may not be able to detect the vehicle ahead. In these cases, the FCA system may not operate normally. The driver must pay careful attention in the following situations where the FCA operation may be limited.

Recognizing vehicles

The sensor may be limited when:

- The radar sensor or camera is blocked with a foreign object or debris.
- The camera lens is contaminated due to tinted, filmed or coated windshield, damaged glass, or stuck of foreign matter (sticker, bug, etc.) on the glass.
- Inclement weather such as heavy rain or snow obscures the field of view of the radar sensor or camera.
- There is interference by electromagnetic waves.
- Something in the path of travel deflects the radar waves.
- The radar/camera sensor recognition is limited.
- The vehicle in front is too small to be detected (for example a motorcycle etc.)
- The vehicle in front is an oversize vehicle or trailer that is too big to be detected by the camera recognition system (for example a tractor trailer, etc.)
- The camera's field of view is not well illuminated (either too dark or too much reflection or too much backlight that obscures the field of view)
- The vehicle in front does not have their rear lights on or their rear lights are located unusually.
- The outside brightness changes suddenly, for example when entering or exiting a tunnel.
- When light coming from a street light or an oncoming vehicle is reflected on a wet road surface such as a puddle in the road.
- The field of view in front is obstructed by sun glare.
- The windshield glass is fogged up; a clear view of the road is obstructed.
- The vehicle in front is driving erratically.
- The vehicle is on unpaved or uneven rough surfaces, or road with sudden gradient changes.
- The vehicle is driven near areas containing metal substances as a construction zone, railroad, etc.

- The vehicle drives inside a building, such as a basement parking lot.
- The camera does not recognize the entire vehicle in front.
- The camera is damaged.
- The brightness outside is too low such as when the headlamps are not on at night or the vehicle is going through a tunnel.
- A shadow is on the road by a median strip, trees, etc.
- The vehicle drives through a toll-gate.
- The windshield glass is fogged up; a clear view of the road is obstructed.
- The rear part of the vehicle in front is not fully visible. (the vehicle turns in other direction or the vehicle is overturned.)
- Adverse road conditions cause excessive vehicle vibrations while driving.
- The sensor recognition changes suddenly when passing over a speed bump.
- The vehicle in front is moving vertically to the driving direction.
- The vehicle in front is stopped vertically.
- The vehicle in front is driving towards your vehicle or reversing.
- You are on a roundabout and the vehicle in front circles.

Driving on a curve



ODEEV078027NR

The FCA performance may be limited while driving on a curve. The FCA may not recognize the vehicle in front even in the same lane. The FCA system may produce the warning message and the warning alarm prematurely, or it may not produce the warning message or the warning alarm at all.

Also, in certain instances the front radar sensor or camera recognition system may not detect the vehicle traveling on a curved road.

When driving on a curve, the driver must maintain a safe braking distance, and if necessary, depress the brake pedal to reduce your driving speed in order to maintain a safe distance.



ODEEV078028NR

The FCA system may recognize a vehicle in the next lane when driving on a curved road.

In this case, the system may alarm the driver and apply the brake. Always pay attention to road and driving conditions, while driving. If necessary, depress the brake pedal to reduce your driving speed in order to maintain a safe distance.

Also, when necessary depress the accelerator pedal to prevent the system from unnecessarily decelerating your vehicle.

Always check the traffic conditions around the vehicle.

Driving on a slope



ODEEV078128NR

The FCA performance may be limited while driving upward or downward on a slope, and may not recognize the vehicle in front in the same lane. It may produce the warning message and the warning alarm prematurely, or it may not produce the warning message and the warning alarm at all.

When the FCA suddenly recognizes the vehicle in front while passing over a slope, you may experience sharp deceleration.

Always keep your eyes forward while driving upward or downward on a slope, and, if necessary, depress the brake pedal.

Changing lanes

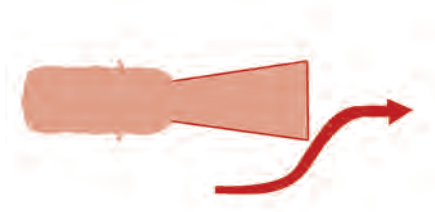

ODEEV078030NR

When a vehicle changes lanes in front of you, the FCA system may not immediately detect the vehicle, especially if the vehicle changes lanes abruptly. In this case, you must maintain a safe braking distance, and if necessary, depress the brake pedal to reduce your driving speed in order to maintain a safe distance.



ODEEV078056NR

When driving in stop-and-go traffic, and a stopped vehicle in front of you merges out of the lane, the FCA system may not immediately detect the new vehicle that is now in front

of you. In this case, you must maintain a safe braking distance, and if necessary, depress the brake pedal to reduce your driving speed in order to maintain a safe distance.

Recognizing the vehicle

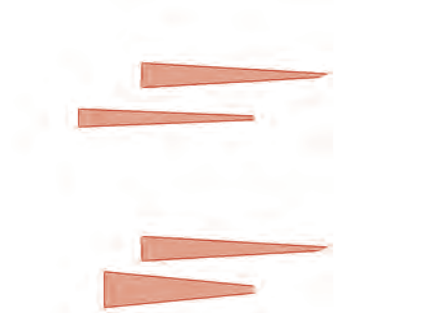

ODEEV078129NR

Detecting the vehicle in front of you If the vehicle in front of you has cargo that extends rearward from the cab, or when the vehicle in front of you has higher ground clearance, additional special attention is required.

The FCA system may not be able to detect the cargo extending from the vehicle. In these instances, you must maintain a safe braking distance from the rearmost object, and if necessary, depress the brake pedal to reduce your driving speed in order to maintain distance.

Recognizing pedestrians

Be cautious in the following situations, as the pedestrian may not be detected by the system.

- The pedestrian is not fully captured by the camera sensor, or the pedestrian does not walk in the upright position.
- The pedestrian moves very fast.
- The pedestrian abruptly appears in front.
- The pedestrian wears clothes in the color similar to the background.
- The outside is too bright or too dark.
- The vehicle drives at night or in the darkness.
- There is an item similar to a person's body structure.
- The pedestrian is small.
- The pedestrian has impaired mobility.
- It is difficult to distinguish the pedestrian from the surroundings.
- The sensor recognition is limited due to weather conditions.
- There is a group of pedestrians.
- A sudden change in the sensor recognition takes place while passing through the speed bump.
- The vehicle is severely shaken due to adverse road conditions.
- Driving around circular intersection with a vehicle in front.
- The front of the camera lens is contaminated by front glass tinting, film, water repellent coating, damage on glass, foreign matter (sticker, insect, etc.)
- The radar or camera or camera lens is damaged.
- The headlights of the vehicle are not used at night or in the tunnel section, or the light is too weak.
- The street light or the light of the vehicle coming from the opposite is reflected or when sunlight is reflected by the water on the road surface.
- When the back light is projected in the direction of the vehicle's motion (including the headlights of vehicles).
- Road sign, shadow on the road, tunnel entrance, toll gate, partial pavement.
- The windshield has moisture on its surface or if windshield freezes.
- Driving in the fog.
- Objects are out of the sensing range of the sensor or radar.
- When the cyclist in front is riding intersected with the driving direction.
- When there is any other electromagnetic interference.
- When the construction area, rail or other metal object is near the pedestrian.
- If the bicycle material is not reflected well on the radar.

⚠ WARNING

- Cancel the FCA in the User Settings on the LCD display, before towing another vehicle. While towing, the brake application may adversely affect your vehicle safety.
- Exercise extreme caution to the vehicle in front, when it has heavy loading extended rearward, or when it has higher ground clearance.
- The FCA system is designed to detect and monitor the vehicle ahead or detect a pedestrian in the roadway through radar signals and camera recognition. It is not designed to detect bicycles, motorcycles, or smaller wheeled objects such as luggage bags, shopping carts, or strollers.
- Never try to test the operation of the FCA system. Doing so may cause severe injury or death.
- When replacing or reinstalling the windshield, front bumper or radar/camera after removal, take your vehicle to an authorized Kia dealer and have the system checked.

This device complies with Part 15 of the FCC rules.

Operation is subject to the following three conditions:

1. This device may not cause harmful interference, and
2. This device must accept any interference received, including interference that may cause undesired operation.
3. Changes or modifications not expressly approved by the party responsible for compliance could void the user’s authority to operate the device.

Radio frequency radiation exposure information:

This equipment complies with FCC radiation exposure limits set forth for an uncontrolled environment.

This equipment should be installed and operated with minimum distance of 8 in (20 cm) between the radiator (antenna) and your body.

This transmitter must not be co-located or operating in conjunction with any other antenna or transmitter.

*** NOTICE**

In some instances, the FCA system may be canceled when subjected to electromagnetic interference.

Smart Cruise Control with Stop & Go System (if equipped)

The smart cruise control system is designed to allow you to program the vehicle to maintain a constant speed and a predetermined distance to the vehicle ahead without depressing the accelerator or brake pedal.

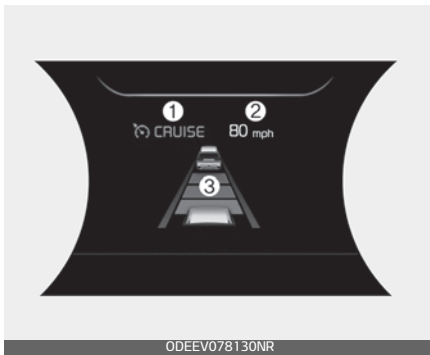

1. Cruise indicator
2. Set speed
3. Vehicle-to-vehicle distance

⚠ WARNING

For your safety, please read the owner's manual before using the smart cruise control system.

*** NOTICE**

To activate smart cruise control, depress the brake pedal at least once after turning the POWER button to the ON position or starting the vehicle. This is to check if the brake switch which is important part to cancel smart cruise control is in normal condition.

⚠ WARNING

Smart cruise control system Limitations

The smart cruise control system is a supplemental system and is not a substitute for safe driving practices. It is the responsibility of the driver to always check the speed and distance to the vehicle ahead.

WARNING

- If the smart cruise control is left on, (cruise indicator in the instrument cluster illuminated) the smart cruise control can be activated unintentionally. Keep the smart cruise control system off (cruise indicator off) when the smart cruise control is not being used.
 - Use the smart cruise control system only when traveling on open highways in good weather.
 - Do not use the smart cruise control when it may not be safe to keep the car at a constant speed. For instance.
 - Highway interchange and toll-gate
 - Road surrounded by multiple steel constructions (subway construction, steel tunnel, etc)
 - Parking lot
 - Lanes beside guard rail on a road
 - Slippery road with rain, ice, or snow
 - Abrupt curved road
 - Steep hills
 - Windy roads
 - Off roads
 - Rods under construction
 - Rumble strip
 - When driving near crash barriers
 - When driving on a sharp curve
 - When the vehicle sensing ability decreases due to vehicle modification resulting level difference of the vehicle's front and rear
 - When driving in heavy traffic or when traffic conditions make it difficult to drive at a constant speed
 - Limited visibility (rain, snow, smog, etc.)
- Pay particular attention to the driving conditions whenever using the smart cruise control system.
 - Be careful when driving downhill using the SCC.
 - Cruise function should not be used when the vehicle is being towed to prevent any damage.
 - Always set the vehicle speed under the speed limit in your country.
 - Always pay continuous attention to road and driving conditions even when the smart cruise control system is being operated.
-

Smart Cruise Control switch

The smart cruise control switch has the following functions.

- CANCEL: Cancels cruise control operation.
- CRUISE: Turns cruise control system on or off.
- RES+: Resumes or increases cruise control speed.

- SET-: Sets or decreases cruise control speed.
- : Sets vehicle-to-vehicle distance

Setting Smart Cruise Control speed

1. Press the CRUISE button, to turn the system on. The CRUISE indicator in the instrument cluster will illuminate.



ODEEV078058NR

2. Accelerate to the desired speed. The smart cruise control speed can be set as follows:
- 5 mph (10 km/h) ~ 100 mph (160 km/h): when there is no vehicle in front
 - 0 mph (0 km/h) ~ 100 mph (160 km/h): when there is a vehicle in front
3. Move the lever down (to SET-), and release it at the desired speed. The set speed and vehicle to vehicle distance on the LCD screen will illuminate.



ODEEV078059NR

4. Release the accelerator pedal. The desired speed will automatically be maintained.

* NOTICE

If there is a vehicle in front of you, the speed may decrease to maintain the distance to the vehicle ahead. On a steep grade, the vehicle may slow down or speed up slightly while going uphill or downhill.

Vehicle speed may decrease on an upward slope and increase on a downward slope.

The speed will be set to 20 mph (30 km/h) when there is a vehicle ahead and your vehicle speed is 0 mph (0 km/h) ~ 20 mph (30 km/h).

Increasing Smart Cruise Control set speed



ODEEV078060NR

Follow either of these procedures:

- Move the lever up (to RES+), and hold it. Your vehicle set speed will increase by 5 mph (10 km/h). Release the lever at the speed you want.
- Move the lever up (to RES+), and release it immediately. The cruising speed will increase by 1.0 mph (1.0 km/h) each time you move the lever up (to RES+) in this manner.

You can set the speed to a maximum speed of 100 mph (160 km/h). However, all speed limit laws must be followed.

CAUTION

Check the traffic and driving conditions before using the toggle switch. Driving speed may sharply increase, when you push up and hold the toggle switch.

Decreasing Smart Cruise Control set speed



ODEEV078059NR

Follow either of these procedures:

- Move the lever down (to SET-), and hold it. Your vehicle set speed will decrease by 5 mph (10 km/h). Release the lever at the speed you want.
- Move the lever down (to SET-), and release it immediately. The cruising speed will decrease by 1.0 mph (1.0 km/h) each time you move the lever down (to SET-) in this manner.

You can set the cruise control speed above 20 mph (30 km/h).

Accelerating temporarily with Smart Cruise Control on

- If you want to speed up temporarily when the cruise control is on, depress the accelerator pedal. Increased speed will not interfere with cruise control operation or change the set speed.
- To return to the set speed, take your foot off the accelerator.

- If you move the lever down (to SET-) at increased speed, the cruising speed will be set again.

* NOTICE

Be careful when accelerating temporarily, because the speed is not controlled automatically at this time even if there is a vehicle in front of you.

Smart Cruise Control will be temporarily canceled when:

You are able to temporarily cancel the smart cruise control. In some circumstances, the smart cruise control will cancel automatically.

Canceled manually



ODEEV078065NR

The smart cruise control is temporarily canceled when the brake pedal is depressed or the CANCEL button is pressed.

Depress the brake pedal and press the CANCEL button at the same time, when the vehicle is at a standstill. The speed and vehicle to vehicle distance indicator on the cluster is disappeared and the CRUISE indicator is illuminated continuously.

Canceled automatically

Smart cruise control will automatically cancel in the following situations. (the set speed and vehicle to vehicle distance on the LCD display will go off.)

- The driver's door is opened.
- The shift lever is shifted to N (Neutral), R (Reverse) or P (Parking).
- The EPB (electronic parking brake) is applied.
- The vehicle speed is over 100 mph (160 km/h)
- The ESC, ABS or TCS is operating.
- The ESC is turned off.
- The sensor or the cover is dirty or blocked with foreign matter.
- When the vehicle is stopped for over 5 minutes.
- The driver starts driving by pushing the toggle switch up (RES+)/down (SET-) or depressing the accelerator pedal, after stopping the vehicle with a vehicle stopped far away in front.
- The accelerator pedal is continuously depressed for long time.

- The SCC system has malfunctioned.
- When the braking control is operated for Forward Collision-Avoidance Assist (FCA).
- The driver starts driving by pushing the toggle switch up (RES+)/down (SET-) or depressing the accelerator pedal, after the vehicle is stopped by the Smart Cruise Control system with no other vehicle ahead.
- The vehicle stops and goes repeatedly for a long period of time.
- When the parking brake is locked.

If the smart cruise control is canceled automatically, the smart cruise control will not resume even though the RES+ or SET- lever is moved.

*** NOTICE**

If the smart cruise control is canceled during a situation is that is not described above, take your vehicle to an authorized Kia dealer and have the system checked.

*** NOTICE**



If the system is automatically canceled, the warning chime will sound and a message will appear for a few seconds.

You must adjust the vehicle speed by depressing the accelerator or brake pedal according to the road condition ahead and driving conditions.

Always check the road conditions. Do not rely on the warning chime.

Resuming Smart Cruise Control set speed



ODEEV078060NR

- If any method other than the "RES+" or "SET-" lever was used to cancel cruising speed and the system is still activated, the cruising speed will automatically resume when you push the lever up (RES+) or down (SET-).
- If you push the lever up (RES+), the speed will resume to the recently set speed. However, if vehicle speed drops below 5 mph (10 km/h), it will resume when there is a vehicle in front of your vehicle.

⚠ WARNING

- To avoid collisions, always be aware of the selected speed and vehicle to vehicle distance settings when activating your smart cruise control system.
- Always maintain sufficient braking distance and decelerate your vehicle by applying the brakes if necessary.

Turning Smart Cruise Control off



ODEEV078058NR

When the Smart Cruise Control System is not needed, press the [CRUISE] switch and deactivate the system.

- Press the CRUISE button (The CRUISE indicator light will go off.)

Setting vehicle-to-vehicle distance

You can program the vehicle to maintain a predetermined distance to the vehicle ahead without depressing the accelerator pedal or brake pedal.



ODEEV078067NR

- The vehicle to vehicle distance will automatically activate when the smart cruise control system is on.
- Select the appropriate distance according to road conditions and vehicle speed.
- Each time the button is pressed, the vehicle to vehicle distance changes as follows:

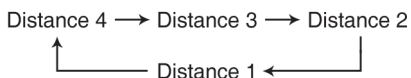

For example, if you drive at 56 mph (90 km/h), the distance maintain as follows;

Distance 4 - approximately 172 ft (52.5 m)

Distance 3 - approximately 131 ft (40 m)

Distance 2 - approximately 107 ft (32.5 m)

Distance 1 - approximately 82 ft (25 m)

*** NOTICE**

The distance is set to the last set distance when the system is used for the first time after starting the vehicle.

When the lane ahead is clear:



The vehicle speed will maintain the set speed.

⚠ WARNING

Following Distance

- To avoid collisions, always be aware of the selected speed and vehicle to vehicle distance settings when activating your smart cruise control system.
- Always maintain sufficient braking distance and decelerate your vehicle by applying the brakes if necessary.

When there is a vehicle ahead of you in your lane:



ODEEV078069NR

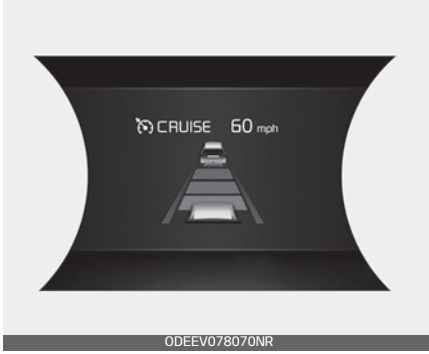

ODEEV078070NR

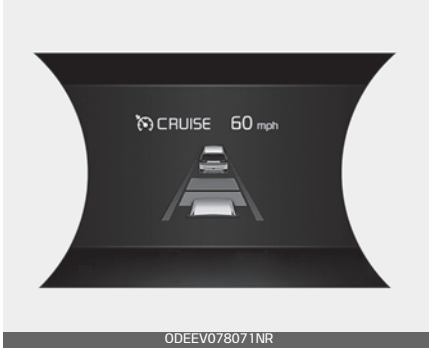

ODEEV078071NR



ODEEV078072NR

The vehicle will maintain the set speed, when the lane ahead is clear.

The vehicle will slow down or speed up to maintain the selected distance, when there is a vehicle ahead of you in the lane. (A vehicle will appear in front of your vehicle in the LCD display only when there is an actual vehicle in front of you)

If the vehicle ahead speeds up, your vehicle will travel at a steady cruising speed after accelerating to the selected speed.

CAUTION

- The warning chime sounds and LCD display blinks if it is hard to maintain the selected distance to the vehicle ahead.
- If the warning chime sounds, actively adjust the vehicle speed by depressing the brake pedal according to the road and driving conditions.
- Even if the warning chime is not activated, always pay attention to the driving conditions to prevent dangerous situations from occurring.
- Be alert to road conditions as radio, loud sounds and outside conditions could prevent occupants from hearing a warning sound.

denly appear in front of you by depressing the brake pedal according to the road and driving conditions.

In traffic situation

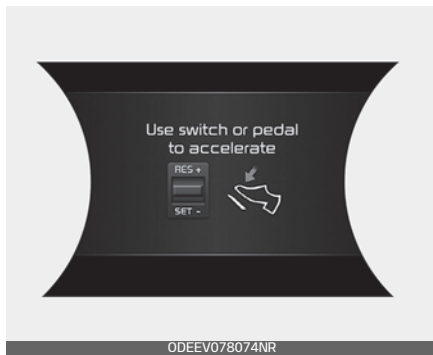

Use switch or pedal to accelerate

- In traffic, your vehicle will stop if the vehicle ahead of you stops. Also, if the vehicle ahead of you starts moving, your vehicle will start as well. However, if the vehicle stops you must depress the accelerator pedal or push up the toggle switch (RES+) to start driving.

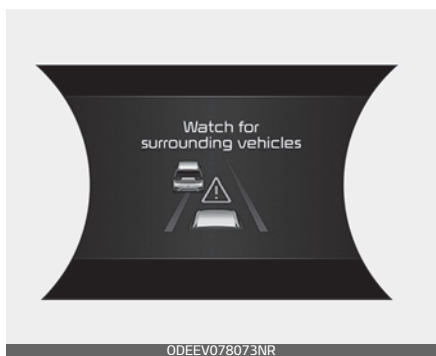

If the vehicle ahead (vehicle speed: less than 20 mph (30 km/h)) moves to the next lane, the warning chime will sound and a message will appear. Adjust your vehicle speed for vehicles or objects that can sud-

- If you push the smart cruise control toggle switch (RES+ or SET-) while Auto Hold and smart cruise control is operating the Auto Hold will be released regardless of accelerator pedal operation and the vehicle will start to move. The AUTO HOLD indicator changes from green to white. (if equipped with EPB (Electronic Parking Brake))

Radar to detect distance to the vehicle ahead



ODEEV078051NR

The sensor detects the distance to the vehicle ahead.

If the sensor is covered with dirt or other foreign matter, the vehicle to vehicle distance control may not operate correctly.

Always keep the area in front of the sensor clean.

Warning message

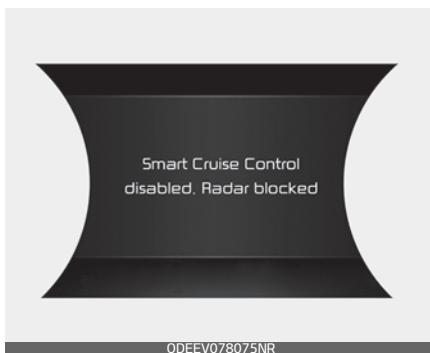

ODEEV078075NR

When the sensor lens cover is blocked with dirt, snow, or debris, the Smart Cruise Control System operation may stop temporarily. If this occurs, a warning message will appear on the LCD display. Remove any dirt, snow, or debris and clean the radar sensor lens cover before operating the Smart Cruise Control System.

The Smart Cruise Control system may not properly activate, if the radar is totally covered, or if any vehicles are not detected after turning ON the vehicle (e.g. in an open terrain).

SCC (smart cruise control) malfunction message

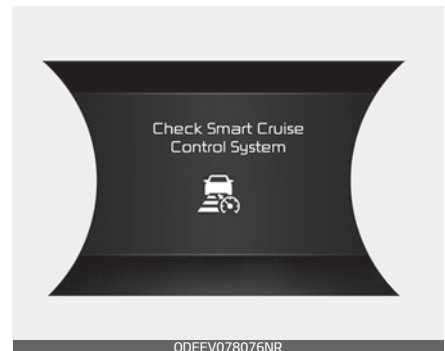

ODEEV078076NR

The message will appear when the vehicle to vehicle distance control system is not functioning normally.

In this case, take your vehicle to an authorized Kia dealer and have the system checked.

⚠ CAUTION

- Do not install accessories around the sensor and do not replace the bumper by yourself. It may interfere with the sensor performance.
- Always keep the sensor and bumper clean.
- Use only a soft cloth to wash the vehicle. Do not spray pressurized water directly on the sensor or sensor cover.
- Be careful not to apply unnecessary force on the radar sensor or sensor cover. If the sensor is forcibly moved out of proper alignment, the Smart Cruise Control System may not operate correctly. In this case, a warning message may not be displayed. Have the vehicle inspected by an authorized Kia dealer.
- Do not damage the sensor or sensor area by a strong impact. If the sensor moves slightly off position, the smart cruise control system will not operate correctly without any warning or indicator from the cluster. If this occurs, take your vehicle to an authorized Kia dealer and have the system checked.
- Use only a genuine Kia sensor cover for your vehicle. Do not paint anything on the sensor cover.
- If the front bumper becomes damaged in the area around the radar sensor, the Smart Cruise Control System may not operate properly.

Adjusting the sensitivity of Smart Cruise Control

The sensitivity of vehicle speed when following the front vehicle to maintain the set distance can be adjusted.

- Go to the 'User Settings → Driver Assistance → SCC Reaction' on the LCD display.

You may select one of the three stages you prefer.

- Slow: Vehicle speed to the vehicle ahead to maintain the set distance is slower than normal speed.
- Normal: Vehicle speed to the vehicle ahead to maintain the set distance is normal
- Fast: Vehicle speed to the vehicle ahead to maintain the set distance is faster than normal speed.

*** NOTICE**

The last selected mode remains in the system.

Converting to Cruise Control mode

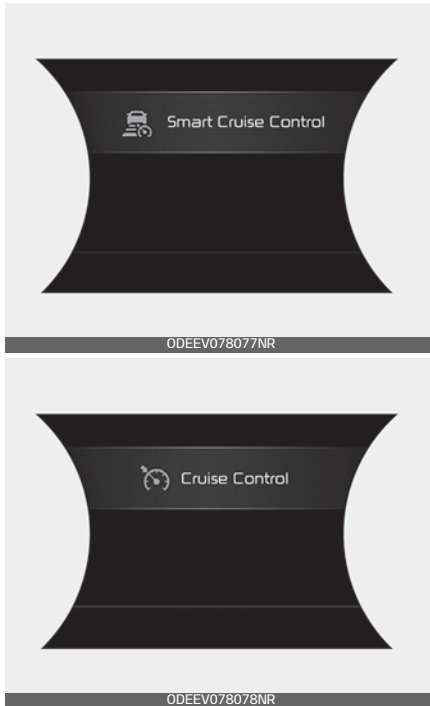

The driver may choose to only use the cruise control mode (speed control function) by doing as follows:

1. Turn the smart cruise control system on (the cruise indicator light will be on but the system will not be activated).
2. Push the distance to distance switch for more than 2 seconds.
3. Choose between "Smart Cruise Control" and "Cruise Control".

When the system is canceled using the CRUISE button or the CRUISE button is used after the vehicle is turned on, the Smart Cruise Control mode will turn on.

⚠ WARNING

When using the cruise control mode, you must manually assess the distance to other vehicles as the system will not automatically brake to slow down for other vehicles.

Limitations of the Smart Cruise Control

The smart cruise control system may have limits to its ability to detect distance to the vehicle ahead due to road and traffic conditions.

Driving on a curve



ODEEV078027NR

On curves, the smart cruise control system may not immediately detect a moving vehicle in your lane, and then your vehicle could accelerate to the set speed. Also, the vehicle speed will rapidly decrease when the vehicle ahead is recognized suddenly.

Select the appropriate set speed on curves and adjust your vehicle speed by depressing the accelerator or brake pedal according to the road and driving conditions ahead.



ODEEV078028NR

Your vehicle speed can be reduced due to a vehicle in the adjacent lane. Adjust your vehicle speed by depressing the brake pedal according to the road and driving conditions ahead.

Adjust your speed by depressing the brake pedal or applying the accelerator pedal according to road and driving conditions ahead. Check to be sure that the road conditions permit safe operation of the smart cruise control.

Driving on a slope



ODEEV078029NR

During uphill or downhill driving, the smart cruise control system may not immediately detect a moving vehicle in your lane, and may cause your vehicle to accelerate to the set speed.

Also, the vehicle speed will rapidly down when the vehicle ahead is recognized suddenly.

Select the appropriate set speed on inclines and adjust your vehicle speed by depressing the accelerator or brake pedal according to the road and driving conditions ahead.

Changing lanes

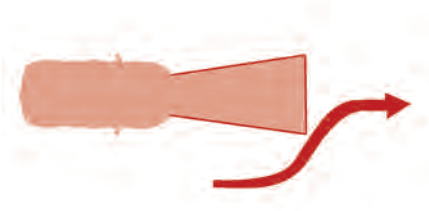

ODEEV078030NR

A vehicle which moves into your lane from an adjacent lane cannot be recognized by the sensor until it is in the sensor's detection range.

The sensor may not detect immediately when a vehicle cuts in suddenly. Always pay attention to the traffic, road and driving conditions.

If a vehicle which moves into your lane is slower than your vehicle, your speed may decrease to maintain the distance to the vehicle ahead.

If a vehicle which moves into your lane is faster than your vehicle, your vehicle will accelerate to the selected speed.



ODEEV078079NR

Your vehicle may accelerate when a vehicle ahead of you disappears.

When you are warned that the vehicle ahead of you is not detected, drive with caution.

Recognizing the vehicle



ODEEV078031NR

Some vehicles ahead in your lane cannot be recognized by the sensor as follows:

- Narrow vehicles such as motorcycles or bicycles
- Vehicles offset to one side
- Slow-moving vehicles or sudden-decelerating vehicles
- Stopped vehicles

- Vehicles with small rear profiles such as trailers with no loads

A vehicle ahead cannot be recognized correctly by the sensor if any of following occurs:

- When the vehicle is pointing upwards due to overloading in the trunk (liftgate)
- While making turns by steering
- When driving to one side of the lane
- When driving on narrow lanes or on curves

Adjust your vehicle speed by depressing the brake pedal according to the road and driving conditions ahead.



ODEEV078056NR

When vehicles are at a standstill and the vehicle in front of you changes to the next lane, be careful when your vehicle starts to move because it may not immediately recognize the stopped vehicle in front of you.

In this case, you must maintain a safe braking distance, and if necessary, depress the brake pedal to reduce your driving speed in order to maintain a safe distance.



Always look out for pedestrians when your vehicle is maintaining a distance with the vehicle ahead.

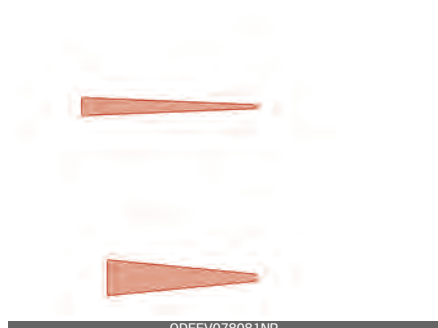

Always be cautious when approaching vehicles that are taller with higher clearance, or vehicles carrying loads that stick out of the back of the vehicle.

⚠ WARNING

When using the Smart Cruise Control take the following precautions:

- If an emergency stop is necessary, you must apply the brakes. The Smart Cruise Control system may not be able to completely stop the vehicle or avoid a collision in every situation.
- Keep a safe distance according to road conditions and vehicle speed. If the vehicle to vehicle distance is too close during a high-speed driving, a serious collision may result.
- Always maintain sufficient braking distance and decelerate your vehicle by applying the brakes if necessary.
- The Smart Cruise Control system cannot recognize a stopped vehicle, pedestrians or an oncoming vehicle.

Always look ahead cautiously to prevent unexpected and sudden situations from occurring.

- Vehicles moving in front of you with a frequent lane change may cause a delay in the system's reaction or may cause the system to react to a vehicle actually in an adjacent lane.

Always drive cautiously to prevent unexpected and sudden situations from occurring.

- Always be aware of the selected speed and vehicle to vehicle distance. The driver should not solely rely on the system but always pay attention to driving conditions and control your vehicle speed.
- The Smart Cruise Control system may not recognize complex driving situations so always pay attention to driving conditions and control your vehicle speed.
- For safe operation, carefully read and follow the instructions in this manual before use.
- Do not use smart cruise control system on steep inclines or when towing another vehicle or trailer since such extreme loading can interfere with your vehicle's ability to maintain the selected speed.

*** NOTICE**

The Smart Cruise Control System may not operate temporarily due to:

- Electrical interference.
- A modified suspension.
- Differences of tire abrasion or tire pressure.
- Installing different type of tires.

This device complies with Part 15 of the FCC rules.

Operation is subject to the following three conditions:

1. This device may not cause harmful interference, and
2. This device must accept any interference received, including interference that may cause undesired operation.
3. Changes or modifications not expressly approved by the party responsible for compliance could void the user's authority to operate the device.

Radio frequency radiation exposure information:

This equipment complies with FCC radiation exposure limits set forth for an uncontrolled environment.

This equipment should be installed and operated with minimum distance of 8 in (20 cm) between the radiator (antenna) and your body.

This transmitter must not be co-located or operating in conjunction with any other antenna or transmitter.

Drive mode integrated control system

The drive mode integrated control system allows the driver to select the drive mode most appropriate to the surrounding environment.

Drive Mode

The drive mode may be selected according to the driver's preference or road condition.



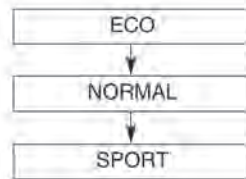

ODEEV078082NR

- The mode changes, as below, whenever the DRIVE MODE button is pressed.



- Press and hold the DRIVE MODE button to select ECO+ mode.

Initial Setting for Each Drive Mode

Drive mode	NORMAL	SPORT	ECO	ECO+ ^{*1}
Feature	Normal driving mode	Sporty driving mode	Optimal for eco-driving	Ultra power saving driving mode
Button activation	Press	Press	Press	Press and hold
Indicator on the cluster	-			
Air conditioner / heater system control	NORMAL (ECO/NORMAL) ^{*2}	NORMAL (ECO/NORMAL) ^{*2}	ECO	Off
Speed limit	-	-	(55 mph~75 mph) ^{*2}	Below 56 mph
Regenerative braking level	1 (1~3) ^{*2}	1 (1~3) ^{*2}	2 (1~3) ^{*2}	2

*1. Change to ECO+ mode

- Distance to empty may not change when the air conditioner / heater system is off. However, actual distance may be extended.
- Air conditioner / heater system turns off (except the defroster) but you may turn it on if necessary.
- When the drive mode is switched from the ECO+ mode to a different mode, it is changed to air conditioner / heater operation status of the ECO mode.
- The speed limit is automatically deactivated when the Smart Cruise Control system is in activation or the accelerator pedal is depressed to the end. If speed limit function is deactivated by depressing the accelerator pedal, the speed limit function will reactivate when vehicle speed is lower than the set speed limit. Also, the speed is changed to the speed set at ECO mode when the drive mode switches from the ECO+ mode to ECO mode.

*2. It is possible to set the driving condition for each drive mode (except the ECO+ mode) at the drive mode setting in the multimedia system. For more information, refer to the separately supplied manual.

Blind-Spot Collision Warning (if equipped)

This is a feature that uses radar sensors installed in the vehicle to prevent a collision or warn of the risk of collision by detecting vehicles in the driver's blind-spot while driving.

Blind-Spot Collision Warning (BCW)

The Blind-Spot Collision Warning (BCW) system uses radar sensors in the rear bumper to monitor and warn the driver of an approaching vehicle in the driver's blind spot area.

The system monitors the rear area of the vehicle and provides information to the driver with an audible alert and a indicator on the outside rearview mirrors.

1. Blind-Spot Area



Note that if your vehicle is traveling much faster than the vehicles around you, the warning will not occur.

2. Closing at high speed



ODEEV078088NR

The Lane Change Assist feature will alert you when it detects a vehicle is approaching in an adjacent lane at a high rate of speed. If the driver activates the turn signal when the system detects an oncoming vehicle, the system sounds an audible alert.

ODEEV078087NR

The blind spot detection range varies relative to vehicle speed.

⚠ WARNING

- Always be aware of road conditions while driving and be alert for unexpected situations even though the Blind-Spot Collision Warning system is operating.
- The Blind-Spot Collision Warning (BCW) system is supplemental systems to assist you. Do not entirely rely on the systems. Always pay attention, while driving, for your safety.
- The Blind-Spot Collision Warning (BCW) system is not a substitute for proper and safe driving. Always drive safely and use caution when changing lanes or backing up the vehicle. The Blind-Spot Collision Warning (BCW) system may not detect every object alongside the vehicle.

Setting and activating the BCW

The driver can activate the system by placing the POWER button to the ON position and by selecting:

- Go to the 'User Settings → Driver Assistance → Blind-Spot Safety' on the LCD display.
 - The BCW is ready to be activated when 'Active Assist' is selected. Then, if a vehicle approaches the driver's blind spot area a warning sounds or braking power is applied.

- Only BCW turns on and is ready to be activated when 'Warning Only' is selected. Then, if a vehicle approaches the driver's blind spot area a warning sounds but braking is not applied.
- The system is deactivated and the indicator on the BCW button is turned off when 'Off' is selected.



ODEEV078090NR

- If you press the BCW switch while 'Active Assist' or 'Warning Only' is selected the indicator on the button will turn off and the system will deactivate.
- If you press the BCW switch while the system is canceled the indicator on the button illuminates and the system activates. In this case, the system returns to the state before the vehicle was turned off. When the system is initially turned on and when the vehicle is turned off then on again while the system is in activation, the warning light will illuminate for 3 sec-

onds on the outer side view mirror.

- If the vehicle is turned off then on again, the system maintains the last setting.

Setting the warning volume of the Blind-Spot Collision Warning

The driver can select the warning volume of Blind-Spot Collision Warning in the User Settings in the LCD display by selecting

- Go to the 'User Settings → Driver Assistance → Warning Volume → High/Medium/Low'.

For more details, refer to "LCD display" on page 5-53.

* NOTICE

If you change the warning volume, the warning volume of other systems may change. Always be aware before changing the warning volume.

- Vehicle speed is between 40 mph and 110 mph (60 km/h and 180 km/h).
- The system detects both of the lane lines.
- An approaching vehicle is detected next to or behind your vehicle.

The Blind-Spot Collision Warning system will activate when:

- The vehicle speed is above approximately 20 mph (30 km/h).

Warning Only

The Blind-Spot Collision Warning system will activate when:

- The vehicle speed is approximately 20 mph (30 km/h).
- * The Blind-Spot Collision-Avoidance Assist system is not activated when "Warning Only" is selected.

Operating Conditions

The system enters the ready status, when 'Active Assist' or 'Warning Only' is selected and the following conditions are satisfied:

Active Assist

The Blind-Spot Collision-Avoidance Assist system will activate when:

Blind-Spot Collision Warning (BCW) alert

The BCW is designed to alert the driver if a vehicle is detected by the radar.

First stage alert



If a vehicle is detected within the boundary of the system, a warning light will illuminate on the outer side view mirror and the head up display (if equipped).

If the detected vehicle is no longer within the blind spot area, the warning will turn off according to the driving conditions of the vehicle.

Second stage alert



[A]: Warning sound

A warning chime to alert the driver will activate when:

1. A vehicle has been detected in the blind spot area by the radar system AND.
2. The turn signal is applied (same side as where the vehicle is being detected).

When this alert is activated, the warning light on the outer side view mirror and the head up display (if equipped) will also blink. And a warning chime will sound.

If you turn off the turn signal indicator, the second stage alert will be deactivated.

If the detected vehicle is no longer within the blind spot area, the warning will turn off according to the driving conditions of the vehicle.

⚠ WARNING

- The warning light on the outer side view mirror will illuminate whenever a vehicle is detected at the rear side by the system. To avoid accidents, do not focus only on the warning light and neglect to see the surrounding of the vehicle.
- Drive safely even though the vehicle is equipped with a Blind-Spot Collision Warning (BCW) system. Do not solely rely on the system but check your surroundings before changing lanes or backing the vehicle up.
- The system may not alert the driver in some situations due to system limitations so always check your surroundings while driving.
- The driver should always use extreme caution while operating the vehicle, whether or not the warning light on the outer side view mirror illuminates or there is a warning alarm.

⚠ CAUTION

- Playing the vehicle audio system at high volume may prevent occupants from hearing the Blind-Spot Collision Warning system warning sounds.
- If any other warning sound such as seat belt warning chime is already generated, the Blind-Spot Collision Warning (BCW) system warning may not sound.

Detecting Sensor (radar)

The BCW operates based on data collected by the rear radars.

Rear radar



ODEEV078094NR

Rear radar

The rear radars are located inside the rear bumper for detecting the side and rear areas. Always keep the rear bumper clean for proper operation of the system.

▲ CAUTION

- The system may not work properly when the bumper has been damaged, or if the rear bumper has been replaced or repaired.
- The sensing range differs somewhat according to the width of the road. When the road is narrow, the system may detect other vehicles in the next lane.
- The system may turn off due to strong electromagnetic waves.
- Always keep the sensors clean.
- NEVER arbitrarily disassemble the sensor component or apply any impact on the sensor component.
- Be careful not to apply unnecessary force on the radar sensor or sensor cover. If the sensor is forcibly moved out of proper alignment, the system may not operate correctly. In this case, a warning message may not be displayed. Have the vehicle inspected by an authorized Kia dealer.
- Do not apply foreign objects such as a bumper sticker or a bumper guard near the radar sensor or apply paint to the sensor area. Doing so may adversely affect the performance of the sensor.

Warning message

If a warning message related to the BCW appears, take the appropriate measures as detailed below.

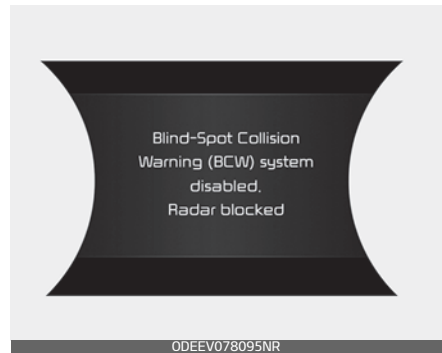
Blind-Spot Collision Warning (BCW) system disabled. Radar blocked

This warning message may appear when:

- One or both of the sensors on the rear bumper is blocked by dirt or snow or a foreign object.
- Driving in rural areas where the sensor does not detect another vehicle for an extended period of time.
- When there is inclement weather such as heavy snow or rain.

If any of these conditions occur, the light on the BCW switch and the system will turn off automatically.

When the BCW canceled warning message is displayed in the cluster check to make sure that the rear bumper is free from any dirt or snow in the areas where the sensor is located. Remove any dirt, snow, or foreign material that could interfere with the radar sensors.

After any dirt or debris is removed, the system should operate normally after about 10 minutes of driving the vehicle.

If the system still does not operate normally have your vehicle inspected by an authorized Kia dealer.

* NOTICE

Turn off the BCW and RCCW system when a trailer or carrier is installed.

- Press the BCW switch (the indicator on the switch will turn off)
- Deactivate the RCCW system by deselecting 'User Settings → Driver Assistance → Blind-Spot Safety → Rear Cross-Traffic Collision Warning' (if equipped)

Check Blind-Spot Collision Warning (BCW) system

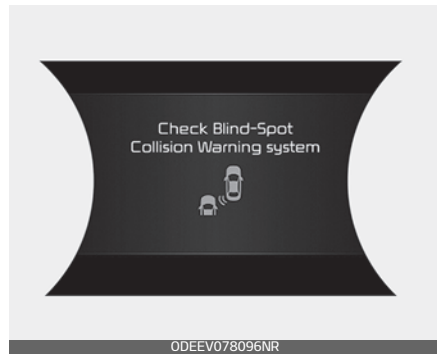

If there is a problem with the BCW system, a warning message will appear and the light on the switch will turn off. The system will turn off automatically. Have your vehicle inspected by an authorized Kia dealer.

Limitations of the BCW

The driver must be cautious in the below situations, because the system may not detect other vehicles or objects in certain circumstances:

- When a trailer or carrier is installed.
- The vehicle driven in inclement weather such as heavy rain or snow.
- The sensor is covered with rain, snow, mud, etc.

- The rear bumper where the sensor is located is covered with a foreign object such as a bumper sticker, a bumper guard, a bike rack, etc.
- The rear bumper is damaged, or the sensor is out of the original default position.
- The vehicle height gets lower or higher due to heavy loading in a trunk, abnormal tire pressure, etc.
- When the temperature of the rear bumper is high.
- When the sensors are blocked by other vehicles, walls or parking-lot pillars.
- The vehicle is driven on a curved road.
- The vehicle is driven through a tollgate.
- The road pavement (or the peripheral ground) abnormally contains metallic components (i.e. possibly due to subway construction).
- There is a fixed object near the vehicle, such as a guardrail.
- While going down or up a steep road where the height of the lane is different.
- Driving on a narrow road where trees or grass or overgrown.
- Driving in rural areas where the sensor does not detect another vehicle or structure for an extended period of time.
- Driving on a wet road.
- Driving on a road where the guardrail or wall is in double structure.
- A big vehicle is near such as a bus or truck.
- When the other vehicle approaches very close.
- When the other vehicle passes at a very fast speed.
- While changing lanes.
- If the vehicle has started at the same time as the vehicle next to you and has accelerated.
- When the vehicle in the next lane moves two lanes away from you OR when the vehicle two lanes away moves to the next lane from you.
- A motorcycle or bicycle is near.
- A flat trailer is near.
- If there are small objects in the detecting area such as a shopping cart or a baby stroller.
- If there is a low height vehicle such as a sports car.
- The brake pedal is depressed.
- ESC (Electronic Stability Control) is activated.
- ESC (Electronic Stability Control) malfunctions.
- The tire pressure is low or a tire is damaged.
- The brake is reworked.
- The vehicle abruptly changes driving direction.
- The vehicle makes sharp lane changes.
- The vehicle sharply stops.

- Temperature is extremely low around the vehicle.
- The vehicle severely vibrates while driving over an uneven/ bumpy road, or concrete patch.
- The vehicle drives on a slippery surface due to snow, water puddle, or ice.
- The Lane Keeping Assist (LKA) or Lane Departure Warning (LDW) do not operate normally. (if equipped)
For more information refer to "Lane Keeping Assist (LKA) System (if equipped)" on page 6-106.

Driving on a curve



ODEEV078097NR

The BCW systems may not operate properly when driving on a curved road. In certain instances, the system may not detect the vehicle in the next lane.

Always pay attention to road and driving conditions, while driving.



ODEEV078098NR

The BCW systems may not operate properly when driving on a curved road. In certain instances, the system may recognize a vehicle in the same lane.

Always pay attention to road and driving conditions, while driving.

Driving where the road is merging/dividing



ODEEV078099NR

The BCW systems may not operate properly when driving where the road is merging/dividing. In certain instances, the system may not detect the vehicle in the next lane.

Always pay attention to road and driving conditions, while driving.

Driving on a slope

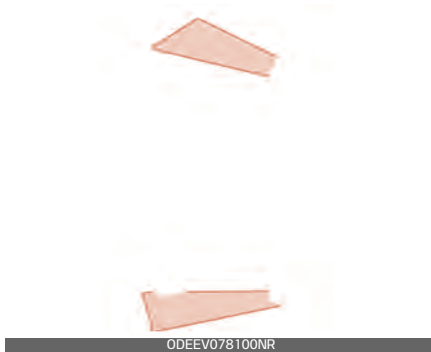

The BCW systems may not operate properly when driving on a slope. In certain instances the system may not detect the vehicle in the next lane.

Also, in certain instances, the system may wrongly recognize the ground or structures.

Always pay attention to road and driving conditions, while driving.

Driving where the heights of the lanes are different



The BCW systems may not operate properly when driving where the heights of the lanes are different.

In certain instances, the system may not detect the vehicle on a road with different lane heights (i.e. underpass joining section, grade separated intersections, etc.).

Always pay attention to road and driving conditions, while driving.

Driving where there is a structure beside the road



ODEEV078132NR

[A]: noise barrier, [B]: guardrail

The BCW systems may not operate properly when driving where there is structure beside the road.

In certain instances, the system may wrongly recognize the structures (i.e. noise barriers, guardrail, double guardrail, median strip, bollard, street light, road sign, tunnel wall, etc.) beside the road.

Always pay attention to road and driving conditions, while driving.

This device complies with Part 15 of the FCC rules.

Operation is subject to the following two conditions:

1. This device may not cause harmful interference, and
2. This device must accept any interference received, including interference that may cause undesired operation.

Rear Cross-Traffic Collision Warning (RCCW) (if equipped)

This is a feature that is designed to prevent collision or warns of the risk of collision by detecting a vehicle approaching from cross traffic using radar sensors installed in the vehicle.

Rear Cross-Traffic Collision Warning (RCCW) system

The Rear Cross-Traffic Collision Warning (RCCW) system uses radar sensors to monitor the approaching cross traffic from the left and right side of the vehicle when your vehicle is in reverse.



ODEEV078102NR

The blind spot detection range varies relative to the approaching vehicle speed.

Setting and activating the RCCW

The driver can activate the systems by placing the POWER button to the ON position and by selecting:

- Go to the 'User Settings → Driver Assistance → Rear Cross-Traffic Collision Warning' on the LCD display.

The RCCW turns on and is ready to be activated when 'Rear Cross-Traffic Collision Warning' is selected.

When the vehicle is turned off then on again, the systems will be ready to be activated.

When the system is initially turned on and when the vehicle is turned off then on again, the warning light will illuminate for 3 seconds on the outer side view mirror.

Operating conditions

The system will activate when vehicle speed is below 6 mph (10 km/h) and with the shift lever in R (Reverse).

* The system will not activate when the vehicle speed exceeds 6 mph (10 km/h). The system will activate again when the speed is below 6 mph (10 km/h).

The system's detecting range is approximately 1~65 ft (0.5~20 m). An approaching vehicle will be detected if the vehicle speed is within 5~22.5 mph (8~36 km/h).

Note that the detecting range may vary under certain conditions. As always, use caution and pay close attention to your surroundings when backing up your vehicle.

Rear Cross-Traffic Collision Warning (RCCW) alert

If the vehicle detected by the sensors approaches from the rear left/right side of your vehicle, the warning chime will sound, the warning light on the outer side view mirror will blink and a message will appear on the LCD display.

Left



ODEEV078103NR

Right



ODEEV078105NR

If the rear view monitor system is in activation, a message will also appear on the instrument cluster or multimedia screen.

The warning will stop when:

- the detected vehicle moves out of the sensing area or
- when the vehicle is right behind your vehicle or
- when the vehicle is not approaching your vehicle or
- when the other vehicle slows down.

⚠ CAUTION

- When the operation condition of the Rear Cross-Traffic Collision Warning system is satisfied, the warning will occur every time a vehicle approaches the side or rear of your stopped (0 mph vehicle speed) vehicle.
- The system's warning or brake may not operate properly if the left or right of your vehicle's rear bumper is blocked by a vehicle or obstacle.
- The driver should always use extreme caution while operating the vehicle, whether or not the warning light on the outer side view mirror illuminates or there is a warning alarm.
- Playing the vehicle audio system at high volume may prevent occupants from hearing the system's warning sounds.
- If any other warning sound such as seat belt warning chime is already generated, the Rear Cross-Traffic Collision Warning system warning may not sound.

⚠ WARNING

- Drive safely even though the vehicle is equipped with a Rear Cross-Traffic Collision Warning system. Do not solely rely on the system but check your surrounding when backing the vehicle up.
- The driver is responsible for accurate brake control.
- Always pay extreme caution while driving. The Rear Cross-Traffic Collision Warning system may not operate properly or unnecessarily operate depending on traffic and driving conditions.

Detecting Sensor

The rear radars are located inside the rear bumper for detecting the side and rear areas. Always keep the rear bumper clean for proper operation of the system.



ODEEV078094NR

⚠ CAUTION

- The system may not work properly when the bumper has been damaged, or if the rear bumper has been replaced or repaired.
- The system may turn off if interfered by electromagnetic waves.
- Always keep the sensors clean.
- NEVER arbitrarily disassemble the sensor component or apply any impact on the sensor component.
- Be careful not to apply unnecessary force on the radar sensor or sensor cover. If the sensor is forcibly moved out of proper alignment, the system may not operate correctly. In this case, a warning message may not be displayed. Have the vehicle inspected by an authorized Kia dealer.
- Do not apply foreign objects such as a bumper sticker or a bumper guard near the radar sensor or apply paint to the sensor area. Doing so may adversely affect the performance of the sensor.

Warning message

If a warning message related to the RCCW appears, take appropriate measures as detailed below.

Blind-Spot Collision Warning (BCW) system disabled. Radar blocked

This warning message may appear when:

- One or both of the sensors on the rear bumper is covered by dirt or snow or a foreign object.
- Driving in rural areas where the sensor does not detect another vehicle for an extended period of time.
- When there is inclement weather such as heavy snow or rain.

If any of these conditions occur, the light on the BCW switch and the system will turn off automatically. When the BCW canceled warning message is displayed in the cluster, check to make sure that the rear bumper is free from any dirt or snow in the areas where the sensor is located. Remove any dirt, snow, or foreign material that could interfere with the radar sensors.

After any dirt or debris is removed, the system should operate normally after about 10 minutes of driving the vehicle.

If the system still does not operate normally have your vehicle inspected by an authorized Kia dealer.

* NOTICE

Turn off the BCW and RCCW system when a trailer or carrier is installed.

- Press the BCW switch (the indicator on the switch will turn off)
- Deactivate the RCCW system by deselecting 'User Settings → Driver Assistance → Rear Cross-Traffic Collision Warning'

Check Blind-Spot Collision Warning (BCW) system

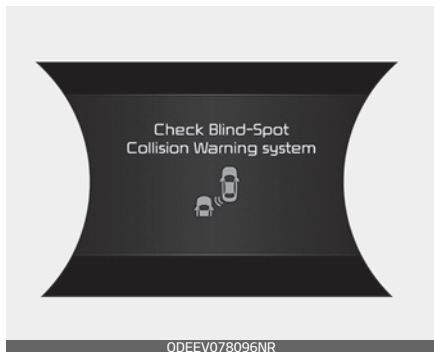

If there is a problem with the BCW system, a warning message will appear and the light on the switch will turn off. The system will turn off automatically. RCCW will not operate also if the BCW system turns off due to malfunction. Have your vehicle inspected by an authorized Kia dealer.

Limitations of the RCCW

The driver must be cautious in the below situations, because the system may not detect other vehicles or objects in certain circumstances.

- When a trailer or carrier is installed.
- The vehicle drives in inclement weather such as heavy rain or snow.
- The sensor is covered with rain, snow, mud, etc.
- The rear bumper where the sensor is located is covered with a foreign object such as a bumper sticker, a bumper guard, a bike rack, etc.
- The rear bumper is damaged, or the sensor is out of the original default position.
- The vehicle height gets lower or higher due to heavy loading in a trunk, abnormal tire pressure, etc.
- When the temperature of the rear bumper is high.
- When the sensors are blocked by other vehicles, walls or parking-lot pillars.
- The vehicle drives on a curved road.
- The road pavement (or the peripheral ground) abnormally contains metallic components (i.e. possibly due to subway construction).
- There is a fixed object near the vehicle, such as a guardrail.

- While going down or up a steep road where the height of the lane is different.
- Driving on a narrow road where trees or grass or overgrown.
- Driving in rural areas where the sensor does not detect another vehicle for an extended period of time.
- Driving on a wet road.
- Driving on a road where the guardrail or wall is in double structure.
- A big vehicle is near such as a bus or truck.
- When the other vehicle approaches very close.
- When the other vehicle passes at a very fast speed.
- While changing lanes.
- If the vehicle has started at the same time as the vehicle next to you and has accelerated.
- When the vehicle in the next lane moves two lanes away from you OR when the vehicle two lanes away moves to the next lane from you.
- A motorcycle or bicycle is near.
- A flat trailer is near.
- If there are small objects in the detecting area such as a shopping cart or a baby stroller.
- If there is a low height vehicle such as a sports car.
- The brake pedal is depressed.
- ESC (Electronic Stability Control) is activated.

- ESC (Electronic Stability Control) malfunctions.
- The tire pressure is low or a tire is damaged.
- The brake is reworked.
- The vehicle sharply stops.
- Temperature is extremely low around the vehicle.
- The vehicle severely vibrates while driving over an uneven/ bumpy road, or concrete patch.
- The vehicle drives on a slippery surface due to snow, water puddle, or ice.

Driving where there is a vehicle or structure near

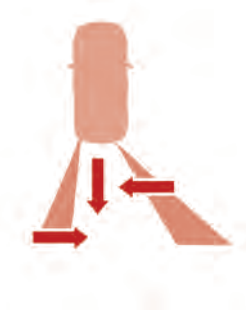

0DEEV078107NR

[A]: Structure

The system may not operate properly when driving where there is a vehicle or structure near.

In certain instances, the system may not detect the vehicle approaching from behind and the warning or brake may not operate properly.

Always pay attention to your surroundings while backing up.

When the vehicle is in a complex parking environment

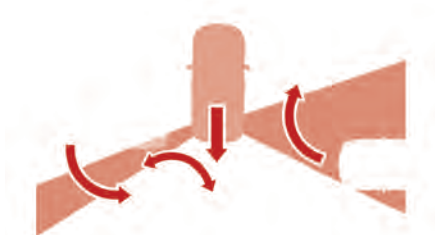

ODEEV078108NR

The system may not operate properly when the vehicle is in a complex parking environment.

In certain instances, the system may not be able to exactly determine the risk of collision for the vehicles which are parking or pulling out near your vehicle (e.g. a vehicle escaping beside your vehicle, a vehicle parking or pulling out in the rear area, a vehicle approaching your vehicle making a turn, etc.).

If this occurs, the warning or brake may not operate properly.

When the vehicle is parked diagonally



ODEEV078109NR

[A]: Vehicle

The system may not operate properly when the vehicle is parked diagonally.

In certain instances, when the diagonally parked vehicle is pulled out of the parking space, the system may not detect the vehicle approaching from the rear left/right of your vehicle. In this case, the warning or brake may not operate properly.

Always pay attention to your surroundings while backing up.

When the vehicle is on/near a slope



ODEEV078110NR

The system may not operate properly when the vehicle is on/near a slope.

In certain instances, the system may not detect the vehicle approaching from the rear left/right and the warning or brake may not operate properly.

Always pay attention to your surroundings while backing up.

Pulling into the parking space where there is a structure



ODEEV078111NR

[A]: Structure, [B]: Wall

The system may not operate properly when pulling in the vehicle to the parking space where there is a structure at the back or side of your vehicle.

In certain instances, when backing into the parking space, the system may not detect the vehicle moving in front of your vehicle. In this case, the warning or brake may not operate properly.

Always pay attention to your surroundings while backing up.

When the vehicle is parked rearward

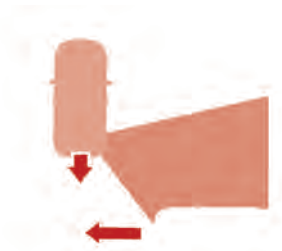

ODEEV078112NR

If the vehicle is parked rearward and the sensor detects the another vehicle in the rear area of the parking space, the system can warn or control braking.

Always pay attention to your surroundings while backing up.

This device complies with Part 15 of the FCC rules.

Operation is subject to the following two conditions:

1. This device may not cause harmful interference, and
2. This device must accept any interference received, including interference that may cause undesired operation.

Driver Attention Warning (DAW) (if equipped)

The Driver Attention Warning (DAW) system is designed to warn the driver of potentially hazardous driving situations if it detects inattentive driving practices.

*** NOTICE**

The Driver Attention Warning system does not detect actual driver fatigue or drowsiness. The system monitors driving and provides a warning if it detects inattentive driving practices.

Setting and activating the DAW

The Driver Attention Warning system is in the Normal position, when your vehicle is first delivered to you from the factory.

To turn ON the Driver Attention Warning system.

- Turn on the vehicle, and then select 'User Settings → Driver Assistance → DAW (Driver Attention Warning) → High sensitivity / Normal sensitivity / Off' on the LCD display.

The driver can select the Driver Attention Warning system mode.

- Off: The Driver Attention Warning system is deactivated.
- Normal sensitivity: The Driver Attention Warning system alerts

the driver of his/her fatigue level or inattentive driving practices.

- High sensitivity: The Driver Attention Warning system alerts the driver of his/her fatigue level or inattentive driving practices faster than Normal mode.

The set-up of the Driver Attention Warning system will be applied when the vehicle is re-started.

Displaying the driver's attention level

The driver can monitor his/her driving conditions on the LCD display.

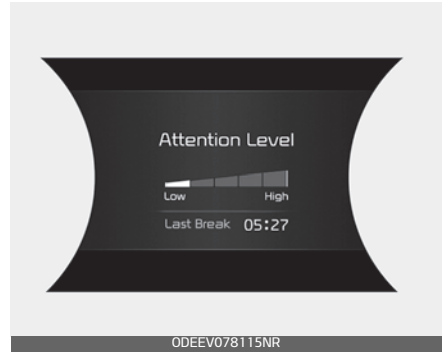

- Select 'User Settings Mode' and then 'Driver Assistance' on the LCD display.

For more information, refer to "LCD display" on page 5-53.

The driver's attention level is displayed on the scale of 1 to 5. The lower the number is, the more inattentive the driver is.

The number decreases when the driver does not take a break for a certain period of time.

The number increases when the driver attentively drives for a certain period of time.

When the driver turns on the system while driving, it displays 'Last Break time' and level reflected that.

Taking a break

The "Consider taking a break" message appears on the LCD display and a warning sounds suggest that the driver take a break when the driver's attention level is below 1.

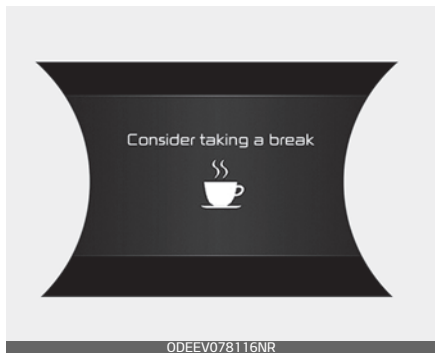

The Driver Attention Warning system will not suggest a break, when the total driving time is shorter than 10 minutes.

⚠ CAUTION

When other warnings such as the seat belt warning sound are in operation, they override the DAW alarming system and DAW warnings may not occur.

Resetting the Driver Attention Warning system



The last break time is set to 00:00 and the driver's attention level is set to 5 (very attentive) when the driver resets the Driver Attention Warning system.

The driver attention warning system resets in the following situations.

- The vehicle is turned OFF.
- The driver unfastens the seat belt and then opens the driver's door in stop.
- The vehicle is parked for more than 10 minutes.

The driver attention warning system operates again, when the driver restarts driving.

DAW disabled

The Driver Attention Warning system enters the ready status and displays the 'Disabled' screen in the following situations.

- The camera sensor is unable to detect the lanes.
- Driving speed remains under 40 mph (64 km/h) or over 110 mph (177 km/h).

DAW malfunction

When the "Check System" warning message appears, the system is not working properly.

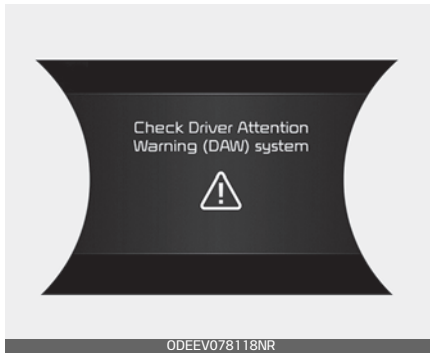

In this case, take your vehicle to an authorized Kia dealer and have the system checked.

⚠ WARNING

- The Driver Attention Warning system is not a substitute for safe driving practices. It is the responsibility of the driver to always drive cautiously to prevent unexpected and sudden situations from occurring. Pay attention to the road conditions at all times.
- It may suggest a break according to the driver's driving pattern or habits even if the driver doesn't feel fatigued.
- The driver, who feels fatigued, should take a break, even though there is no break suggestion by the Driver Attention Warning system.

* NOTICE

The Driver Attention Warning system utilizes the camera sensor on the front windshield for its operation.

To keep the camera sensor in the best condition, you should observe the followings:

- Do not disassemble camera temporarily for tinted window or attaching any types of coatings and accessories. If you disassemble a camera and assemble it again, take your vehicle to an authorized Kia dealer and have the system checked.
- Do not place any reflective objects (i.e. white paper, mirror) over the dashboard. Any light reflection may prevent the Driver Attention Warning (DAW) system from functioning properly.
- Pay extreme caution to keep the camera sensor dry.
- Do not arbitrarily disassemble the camera assembly, or apply any impact on the camera assembly.

* Playing the vehicle audio system at high volume may prevent occupants from hearing the Driver Attention Warning system warning sounds.

⚠ CAUTION

The Driver Attention Warning system may not provide alerts in the following situations:

- The lane detection performance is limited. (For more information, refer to "Lane Keeping Assist (LKA) System (if equipped)" on page 6–106.)
- The vehicle is erratically driven or is abruptly turned for obstacle avoidance (e.g. construction area, other vehicles, fallen objects, bumpy road).
- Forward drivability of the vehicle is severely undermined (possibly due to wide variation in tire pressures, uneven tire wear-out, toe-in/toe-out alignment).
- The vehicle drives on a curvy road.
- The vehicle drives on a bumpy road.
- The vehicle drives through a windy area.
- The vehicle is controlled by the following driver assistance systems:
 - Lane Keeping Assist (LKA) system
 - Forward collision-avoidance assist (FCA) System.
 - Smart Cruise Control (SCC) System

Lane Following Assist (LFA) (if equipped)

With the front camera mounted on the top of the windshield, the Lane Following Assist system is designed to ensure the vehicle stays in its lane by monitoring the detected lane ahead of the car and controlling over the direction of the steering wheel.



⚠ WARNING

- It is the driver's responsibility to operate the steering wheel for safe driving.
- Do not turn the steering wheel hastily if LFA is activated.
- The LFA system assists the steering wheel control over the direction so that the vehicle can stay in the center of the detected lane. The LFA system does not automatically control the steering wheel of at all times, which means the driver must not hands

on the wheel at all times while driving.

- When using the LFA system, always be aware of your surroundings and road conditions that may interrupt or stop the LFA system.

⚠ CAUTION

- Do not attach glass tinting, tickers, accessories to the windshield near the front camera near the indoor mirror is placed.
- The removal or re-assembly of the front camera to attach tinting, stickers, accessories may require the LFA system to be thoroughly inspected and modified. In such case, have the system be inspected by an authorized Kia dealer.
- Inspection or modification may be required when replacing parts related to the windshield or front camera, steering. Have the system be inspected by an authorized Kia dealer.
- Depending on your surroundings and road conditions, the LFA system could fail to recognize the lane and stop working. As such, extra caution is required while driving with the LFA system on.
- Be sure to check the non-operating conditions and cautions for the driver before using the LFA system.

- Do not place reflective materials such as white paper or mirror on the dashboard. Sunlight reflections can cause the LFA system to not function properly.
- Loud audio volumes can prevent the occupants from hearing the alarm sounds from the LFA system.
- Keeping your hands off the wheel while driving will trigger the hands-off warning and deactivate the steering-assist system. Put your hands back on the wheel, then the steering-assist system will be reactivated.
- When driving at a high speed, the steering assist force can become weak and the vehicle can drive out of its lane. Extra caution is required, and comply with the speed limit.
- Attaching an object to the steering wheel could deter steering assistance.
- Attaching an object to the steering wheel could deter the hands-off alarming system.

Activating the LFA

To activate/deactivate the LFA, with the POWER button in the ON position, take the following steps:

- Select or release the setting from "User setting → Driver assist → Driving assist → LFA (Lane Following Assist)".

Select the LFA system in the user setting of the instrument panel and meet the following conditions for the system to operate.

- When Smart Cruise Control is in operation (Vehicle deceleration and acceleration control)

Refer to "Smart Cruise Control with Stop & Go System (if equipped)" on page 6-59.

Once the system starts working, the indicator light () comes on the instrument panel.

The indicator light colors according to the system status are as follows.

- Green: steering assist mode on
- White: steering assist mode off

Steering assist

If the vehicle is inside the lane with both lanes detected by the system, and there is no steep steering made by the driver, the LFA system changes into steering assist mode.

The indicator light will come on green, and the system helps the vehicle stay in line by controlling the steering wheel.

When the steering wheel is not controlled temporarily, the indicator light will flash green and changes to white.

Once the LFA system recognizes the lanes, the color of the lane on the

screen will change from gray to white.

Maintenance by car When the car recognizes the lane, the color of the lane changes from gray to white. For more details, refer to menu setting of "LCD Display Modes" on page 5-54.

⚠ WARNING

The LFA system is designed to help the vehicle stay in its detected lane. The LFA system does not guarantee 100% safety. Make sure you make decisions on the road after checking the road conditions and safety matters while driving. Never completely rely on your LFA system.

Warning message

If you keep your hands off the wheel while driving with the LFA system assisting the steering, the hands-off warning will be triggered.

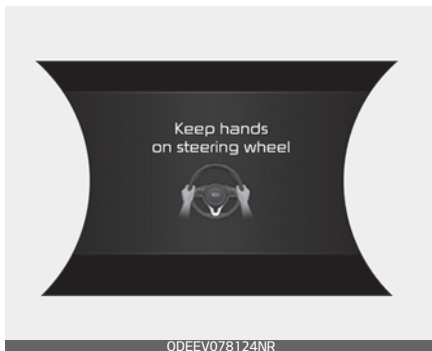

If the driver keeps hands off the wheel even with the hands-off warning on, the steering assist is temporarily released automatically.

If you put your hands back on the wheel with the LFA system released, the steering assist will restart.

⚠ CAUTION

- Hands-off warnings may be delayed depending on road conditions. Always keep your hands on the steering wheel while driving.
- Hold the steering wheel tight. Otherwise, the LFA system could misjudge that the driver's hands are off the wheel, and a hands-off warning may occur.

LFA malfunction

This warning message popped up (turned off after a certain period of time) means a problem with the LFA system.

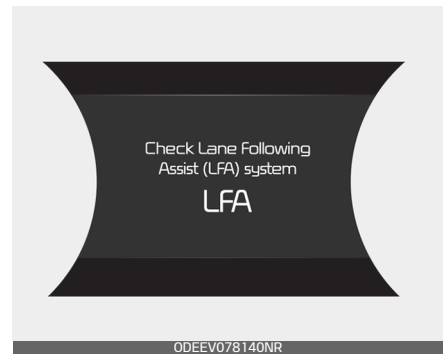

In this case, have the system checked by an authorized Kia dealer.

▲ CAUTION

- It is the driver's responsibility to operate the steering wheel while driving.
 - With the LFA system on, The driver can steer the vehicle by operating the wheel on his own.
 - We recommend that the driver turn off the LFA system and operate the steering wheel by himself in the following situations:
 - bad weather
 - bad road conditions
 - when frequent operation of the steering wheel is required
 - When towing other vehicle or trailers
 - The steering wheel can feel heavy or light if the LFA system is assisting the steering.
-
- Once the LFA system is turned on or the lane is changed, the vehicle should be in the center of the road to switch to the steering assist mode. If the driver keeps driving along the lane, the LFA system will not assist the steering.
 - When the ESC or is activated, the system does not assist steering.
 - When driving on a curved road at a high speed, steering assist mode may not work.
 - When driving at a speed faster than 110 mph (180 km/h), steering assist mode may not work.
 - When sudden steering is made, the system could be temporarily deactivated.
 - If you change the lane in a hurry, the system does not assist the steering.
 - If the vehicle suddenly stops, it does not assist the steering.
 - If the lane is too narrow or too wide, steering is not assisted.
 - If either of the lanes is not recognized, the steering is not assisted
 - If the radius is too small for the curve

Limitations of the LFA

The LFA has the following limitations, so always pay attention to your driving and do not rely solely on the LFA.

- If the driver turns on the turn signal light or the emergency warning light to change the lane
 - Operate the turn signal light switch before changing the lane
 - If you change the lane without operating the turn signal lights, steering reaction force of the wheel may occur.

Cautions for the driver

If the lane recognition is difficult or limited for the LFA system as shown below, the driver may need to be careful because the system may not operate or may cause unnecessary operation.

Roads or lane markings in bad condition

- When the lane is tainted or invisible.
- When the driver cannot see the lane due to rain, snow, dust, sand, oil, puddles, etc.
- When roads are set or the colors of the lane and road are not distinctive.
- If there is a sign other than the lane near the lane or a mark similar to the lane.
- When the lane is not clear or damaged.
- If the road is covered in the shadows of objects around the road, such as medians, guard rails, noise walls, and trees.
- If the number of lanes increases or decreases, or if the lanes intersect with each other more intensely. (tollgate entry section, road section / joining section, etc.)
- When there are two or more lane markings such as a construction section, a designated lane, etc.
- When the lane is crowded such as the construction section or the lane is replaced by some structures.
- If there is a road marking such as a zigzag lane, crosswalk mark, or road surface milestone.
- When a lane suddenly becomes invisible or disappears from an intersection.

The external environment affects the system

- If the outside brightness of the vehicle suddenly changes, such as when entering or exiting the tunnel or passing under the bridge.
- If the vehicle's headlights are not used at night or in the tunnel, or the brightness of the headlights is too weak.
- If there are boundary structures such as tollgate booths and sidewalk blocks.
- If it is difficult to distinguish lanes due to the reflection on the wet road made by sunlight, street-light, and oncoming traffic.
- When the backlight is strongly reflected in the direction of the vehicle.
- When Driving to the left or right lane by bus lane or on the bus lane.
- If there is not enough distance between the front car or if the lane is covered by the car ahead of me.
- When the lane change is large, such as a steep curve or a continuous curve.
- When passing through speed bump, sudden up / down or left / right slope.
- If the vehicle is severely shaken.
- When the temperature around the rearview mirror is very high due to direct sunlight.

If the front camera clock is of poor quality

- If the windshield of the vehicle and the camera lens are covered with dust, fingerprints, or tinting.
- If the camera doesn't work properly due to bad weather such as fog, heavy rain or heavy snow.
- If moisture is not completely removed from the windshield.
- When placing an object on the dashboard, etc.

Lane Keeping Assist (LKA) System (if equipped)

The Lane Keeping Assist system is designed to detect the lane markers on the road with a front view camera at the front windshield, and assists the driver's steering to help keep the vehicle in the lanes.



When the system detects the vehicle straying from its lane, it alerts the driver with a visual and audible warning, while applying a slight countersteering torque, trying to prevent the vehicle from moving out of its lane.

⚠ WARNING

The Lane Keeping Assist System is a supplemental system and is not a substitute for safe driving practices. It is the responsibility of the driver to always pay attention and drive safely.

⚠ WARNING

- Driver is responsible for being aware of surroundings and steering the vehicle for safe driving practices.
- Do not turn the steering wheel suddenly when the steering wheel is being assisted by the system.

*** NOTICE**

- LKA helps prevent the driver from moving out of the lane unintentionally by assisting the driver's steering. However, the system is just a convenience function and the steering wheel is not always controlled. While driving, the driver should pay attention to the steering wheel.
- The operation of the LKA can be canceled or not work properly according to road condition and surroundings. Always be cautious when driving.
- Do not disassemble the front view camera temporarily for tinted window or attaching any types of coatings and accessories. If you disassemble the camera and assemble it again, take your vehicle to an authorized Kia dealer and have the system checked to need a calibration.
- When you replace the windshield glass, front view camera or system, take your vehicle to an authorized Kia dealer and have

the system checked to need a calibration.

- The system is designed to detect lane markers using a front view camera. If the lane markers are hard to detect, then the system may be limited. Always be cautious when using the system.
- When the lane markers are hard to detect, please refer to "Driver's Attention" on page 6-111.
- Do not remove or damage parts of the LKA system.
- Do not place objects on the dashboard that reflects light such as mirrors, white paper, etc. This may prevent the LKA system from functioning properly.
- You may not hear warning sound of LKA if the audio volume is high.
- If you continue to drive with your hands off the steering wheel, the LKA will stop controlling the steering wheel after the hands off alarm. If you drive with your hands on the steering wheel again, the control will be activated again.
- If the vehicle speed is high, steering torque for assistance may not be enough to keep your vehicle within the lane. If so, the vehicle may move out of its lane. Obey speed limit when using LKA.
- If you attach objects to the steering wheel, the system may not assist steering.
- If you attach objects to the steering wheel, hands off alarm may not work properly.

LKA operation



ODEEV078119NR

To activate/deactivate the LKA, with the POWER button in the ON position, take the following steps:

- Press the LKA button located on the instrument panel on the lower left hand side of the driver. The indicator in the cluster display will initially illuminate white. If the indicator (white) was activated in the previous vehicle ON, the system turns on automatically.

If you press the LKA button again, the indicator on the cluster display will go off.

The color of indicator will change depend on the condition of LKA.

- White: Sensor does not detect the lane marker or vehicle speed is less than 40 mph (64 km/h).
- Green: Sensor detects the lane marker and system is able to control the steering.

If the function is turned off in User settings, the system will not oper-

ate. If you select LDW / LKA / Active LKA in User settings, the selected function will be activated.

LKA activation

To see the LKA screen on the LCD display in the cluster, Tab to the ASSIST mode ().

For further details, refer to "LCD Display Modes" on page 5-54.

After LKA is activated, if both lane markers are detected, vehicle speed is over 40 mph (64 km/h) and all the activation conditions are satisfied, a green steering wheel indicator will illuminate and the steering wheel will be controlled.

WARNING

The Lane Keeping Assist system is a system designed to help prevent the driver from leaving the lane. However, the driver should not solely rely on the system but always check the road conditions when driving.

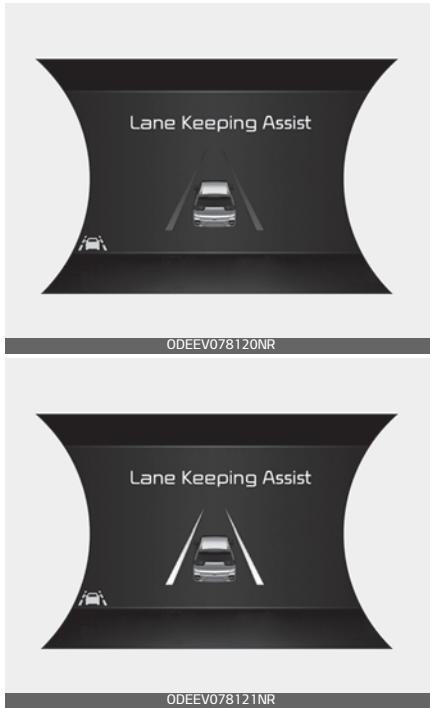

If the speed of the vehicle is over 40 mph (64 km/h) and the system detects lane markers, the color changes from gray to white.

When the conditions below are met, LKA will be enabled to assist steering.

- Vehicle speed is above 40 mph (64 km/h).
- Both lane markers are detected by LKA.
- The vehicle is between the lane markers.

If LKA can assist steering, a green steering wheel indicator will illuminate.

Warning message

If the vehicle leaves a lane, the lane marker you cross will blink on the LCD display.

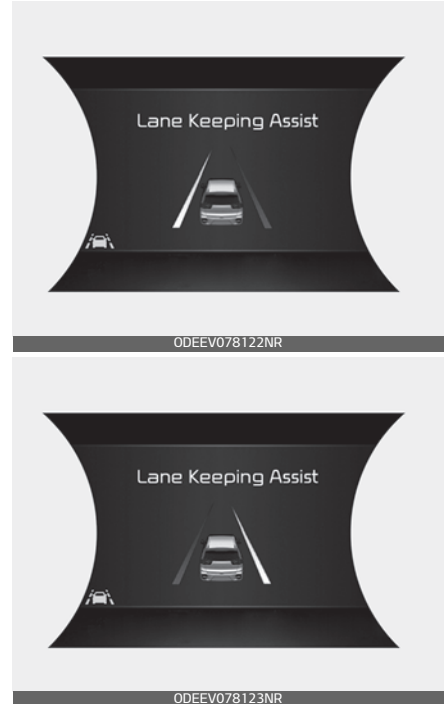

If the vehicle moves out its lane because steering torque for assistance is not enough, the lane indicator will blink.

⚠ WARNING

If all the conditions to activate LKA are not satisfied, the system will convert to LDW and warn the driver only when the driver crosses the lane markers. In this scenario, the LDW system does not provide any steering inputs into the vehicle for you. Accordingly, you must take the necessary steps to maintain control of the vehicle and keep it within the lanes.

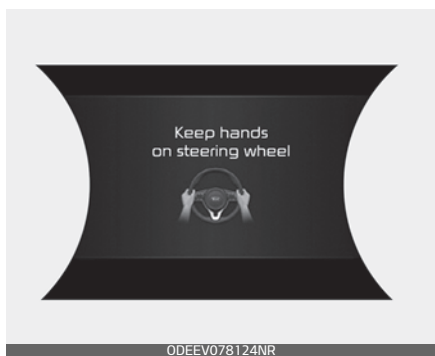

If the driver takes hands off the steering wheel for several seconds while the LKA is activated, the system will warn the driver.

⚠ WARNING

- Always have your hands on the steering wheel while driving.
- If you hold the steering wheel with a light grip, the system may also generate hands off warning because LKA can treat the situation as you do not grab the wheel.

If the driver still does not have their hands on the steering wheel after several seconds, the system will only warn the driver when the driver crosses the lane lines. In this scenario, the system does not provide any steering inputs into the vehicle for you. Accordingly, you must take the necessary steps to maintain control of the vehicle and keep it within the lanes.

However, if the driver has their hands on the steering wheel again, the system will start controlling the steering wheel.

⚠ WARNING

- The LKA system is a supplemental system only. It is the responsibility of the driver to safely steer the vehicle and to maintain it in its lane.
- Even though the steering is assisted by the system, the driver may control the steering wheel.
- Turn off the LKA system and drive without using the system in the following situations:
 - In bad weather
 - In bad road conditions
 - When the steering wheel needs to be controlled by the driver frequently.
- The steering wheel may feel heavier when the steering wheel is assisted by the system than when it is not.

* NOTICE

- Even though the steering is assisted by the system, the driver may control the steering.
- The steering wheel may feel heavier when the steering wheel is assisted by the system than when it is not.

The system will be canceled when:

- You change lanes with the turn signal.
 - Using the turn signal to change lanes.
 - If you change lanes without the turn signal on, the steering wheel might be controlled.
- LKA can transit to steering assist mode when the car is near to middle of the lane after system on or the lane was changed. LKA cannot assist steering if the vehicle follows lane marker too closely.
- The control of ESC (Electronic Stability Control) or VSM (Vehicle Stability Management) is activated.
- The steering will not be assisted when you drive fast on a sharp curve.
- The steering will not be assisted when vehicle speed is below 40 mph (64 km/h), and over 110 mph (177 km/h). Always obey all traffic laws and drive safely.

- The steering will not be assisted when you change lanes quickly.
- The steering will not be assisted when you brake suddenly.
- The steering will not be assisted when the lane is very wide or narrow.
- The steering will not be assisted when only one side lane marker is detected.
- There are more than two lane markers such as a construction area.
- Radius of a curve is too small.
- When you turn the steering wheel suddenly, the LKA will be disabled temporarily.
- Driving on a steep slope or hill.

Driver's Attention

The driver must be cautious in the following situations because the system is limited when recognition of the lane marker is poor or limited:

- When lane and road condition is poor
 - It is difficult to distinguish the lane marker from road when the lane marker is covered with dust or sand.
 - It is difficult to distinguish the color of the lane marker from road.
 - There is something that looks like a lane marker.
 - The lane marker is indistinct or damaged.

- The number of lanes increases/ decreases or the lane lines are crossing (Driving through a toll plaza / toll gate, merged/ divided lane).
- There are more than two lane markers.
- The lane marker is very thick or thin.
- The lane marker is not visible due to snow, rain, stain, a puddle or other factors.
- A shadow is on the lane marker because of a median strip, guardrail, noise barriers or other objects.
- When the lane markers are complicated or a structure substitutes for the lines such as a construction area.
- There are crosswalk signs or other symbols on the road.
- The lane suddenly disappears such as at the intersection.
- The lane marker in a tunnel is covered with dirt or oil and etc.
- When external conditions intervene
 - The brightness of outside changes suddenly when entering/exiting a tunnel or passing under a bridge.
 - The headlamps are not on at night or in a tunnel, or light level is low.
 - There is a boundary structure in the roadway.
 - The light of street, sun, oncoming vehicle and so on reflects from the water on the road.
 - When light shines brightly from behind the vehicle.
 - The distance from the vehicle ahead is very short or the vehicle ahead covers up the lane line.
 - You drive on a steep grade or a sharp curve.
 - The vehicle vibrates heavily.
 - The temperature near the rearview mirror is very high due to direct sun light and etc.
- When front visibility is poor
 - The lens or windshield is covered by foreign materials.
 - The sensor cannot detect the lane because of fog, heavy rain or snow.
 - The windshield is fogged by humid air in the vehicle.
 - Putting something on the crash pad and etc.

WARNING

The Lane Keeping Assist system is a system designed to help prevent the driver from leaving the lane. However, the driver should not solely rely on the system but always take the necessary actions for safe driving practices.

LKA malfunction

If there is a problem with the system a message will appear. If the problem continues the LKA fail indicator will illuminate.



LKA fail indicator

The LKA fail indicator (yellow) will illuminate with an audible warning if the LKA is not working properly. In this case, have the system checked by an authorized Kia dealer.

When there is a problem with the system do one of the following:

- Turn the system on after turning the vehicle off and on again.
- Check if the POWER button is in the ON position.
- Check if the system is affected by the weather. (ex: fog, heavy rain, etc.)
- Check if there is foreign matter covering the camera lens

If the problem is not solved, take your vehicle to an authorized Kia dealer and have the system checked.

LKA function change

The driver can change LKA to Lane Departure Warning (LDW) system from the User Settings Mode on the LCD display.

The driver can choose them by placing the POWER button to the ON position and by selecting 'User Settings', 'Driver Assistance', and 'Lane Safety'.

The system is automatically set to LKA when your vehicle is first delivered from the factory.

Lane Departure

LDW alerts the driver with a visual and acoustic warning when the system detects the vehicle leaving the lane. In this mode, system will not provide steering inputs. When the vehicle's front wheel contacts the inside edge of lane line, LKA issues the lane departure warning.

Special driving conditions

If driving conditions deteriorate due to poor weather or road conditions, you should pay even more attention than usual to your driving.

Hazardous driving conditions

When hazardous driving conditions are encountered such as water, snow, ice, mud, sand, or similar hazards, follow these suggestions:

- Drive cautiously and allow extra distance for braking.
- Avoid sudden braking or steering.
- When braking with non-ABS brakes pump the brake pedal with a light up-and-down motion until the vehicle is stopped.
- Do not pump the brake pedal on a vehicle equipped with ABS.
- If stalled in snow, mud, or sand, use the second gear. Accelerate slowly to avoid spinning the drive wheels.
- Use sand, rock salt, or other non-slip material under the drive wheels to provide traction when stalled in ice, snow, or mud.

Reducing the risk of a rollover

This multi-purpose passenger vehicle is defined as a Sports Utility Vehicle (SUV). Utility vehicles have a significantly higher rollover rate than other types of vehicles. SUV's have higher ground clearance and a narrower track to make them capable of performing in a wide variety of offroad applications.

Specific design characteristics give them a higher center of gravity than ordinary vehicles. An advantage of the higher ground clearance is a better view of the road, which allows you to anticipate problems.

They are not designed for cornering at the same speeds as conventional passenger vehicles, any more than low-slung sports vehicles are designed to perform satisfactorily in off-road conditions. Due to this risk, driver and passengers are strongly recommended to buckle their seat belts.

In a rollover crash, an unbelted person is significantly more likely to die than a person wearing a seat belt. There are steps that a driver can make to reduce the risk of a rollover.

If at all possible, avoid sharp turns or abrupt maneuvers, do not load your roof rack with heavy cargo, and never modify your vehicle in any way.

⚠ WARNING**Rollover**

As with other Sports Utility Vehicle (SUV), failure to operate this vehicle correctly may result in loss of control, an accident or vehicle rollover.

- Utility vehicles have a significantly higher rollover rate than other types of vehicles.
 - Specific design characteristics (higher ground clearance, narrower track, etc.) give this vehicle a higher center of gravity than ordinary vehicles.
 - A SUV is not designed for cornering at the same speeds as conventional vehicles.
 - Avoid sharp turns or abrupt maneuvers.
 - In a rollover crash, an unbelted person is significantly more likely to die than a person wearing a seat belt. Make sure everyone in the vehicle is properly buckled up.
-

⚠ WARNING

Your vehicle is equipped with tires designed to provide safe ride and handling capability. Do not use a size and type of tire and wheel that is different from the one that is originally installed on your vehicle. It can affect the safety and performance of your vehicle, which could lead to steering failure or rollover and serious injury. When replacing the tires, be sure to equip all four tires with the tire and wheel of the same size, type, tread, brand and load-carrying capacity. If you nevertheless decide to equip your vehicle with any tire/wheel combination not recommended by Kia for off road driving, you should not use these tires for highway driving.

Rocking the vehicle

If it is necessary to rock the vehicle to free it from snow, sand, or mud, first turn the steering wheel right and left to clear the area around your front wheels. Then, shift back and forth between R (Reverse) and any forward gear.

Do not race the vehicle, and spin the wheels as little as possible. If you are still stuck after a few tries, have the vehicle pulled out by a tow vehicle to avoid vehicle overheating and possible damage to the reduction gear.

⚠ WARNING**Sudden Vehicle Movement**

Do not attempt to rock the vehicle if people or objects are nearby. The vehicle may suddenly move forward or backwards as it becomes unstuck.

⚠ CAUTION**Vehicle rocking**

Prolonged rocking may cause vehicle overheating, reduction gear damage or failure, and tire damage.

⚠ CAUTION**Spinning tires**

Do not spin the wheels, especially at speeds more than 35 mph (56 km/h). Spinning the wheels at high speeds when the vehicle is stationary could cause a tire to overheat which could result in tire damage that **WARNING** – Sudden may injure bystanders.

The ESC system should be turned OFF prior to rocking the vehicle.

Smooth cornering

Avoid braking or gear changing in corners, especially when roads are wet. Ideally, corners should always be taken under gentle acceleration. If you follow these suggestions, tire wear will be held to a minimum.

Driving at night

Because night driving presents more hazards than driving in the daylight, here are some important tips to remember:

- Slow down and keep more distance between you and other vehicles, as it may be more difficult to see at night, especially in areas where there may not be any street lights.
- Adjust your mirrors to reduce the glare from other driver's headlights.
- Keep your headlights clean and properly aimed. (On vehicles not equipped with the automatic headlight aiming feature.) Dirty or improperly aimed headlights will make it much more difficult to see at night.
- Avoid staring directly at the headlights of oncoming vehicles. You could be temporarily blinded, and it will take several seconds for your eyes to readjust to the darkness.

Driving in the rain

Rain and wet roads can make driving dangerous, especially if you're not prepared for the slick pavement.

Here are a few things to consider when driving in the rain:

- A heavy rainfall will make it harder to see and will increase the distance needed to stop your vehicle, so slow down.

- Keep your windshield wiping equipment in good shape. Replace your windshield wiper blades when they show signs of streaking or missing areas on the windshield.
- If your tires are not in good condition, making a quick stop on wet pavement can cause a skid and possibly lead to an accident. Be sure your tires are in good shape.
- Turn on your headlights to make it easier for others to see you.
- Driving too fast through large puddles can affect your brakes. If you must go through puddles, try to drive through them slowly.
- If you believe you may have gotten your brakes wet, apply them lightly while driving until normal braking operation returns.

Driving in flooded areas

Avoid driving through flooded areas unless you are sure the water is no higher than the bottom of the wheel hub. Drive through any water slowly. Allow adequate stopping distance because brake performance may be affected.

After driving through water, dry the brakes by gently applying them several times while the vehicle is moving slowly.

Driving off-road

Drive carefully off-road because your vehicle may be damaged by rocks or roots of trees. Become familiar with the off-road conditions where you are going to drive before you begin driving.

Highway driving

Tires

Adjust the tire inflation pressures to specification. Low tire inflation pressures will result in overheating and possible failure of the tires.

Avoid using worn or damaged tires which may result in reduced traction or tire failure.

Never exceed the maximum tire inflation pressure shown on the tires.

WARNING

Under/over inflated tires

Always check the tires for proper inflation before driving. Underinflated or overinflated tires can cause poor handling, loss of vehicle control, and sudden tire failure leading to accidents, injuries, and even death. For proper tire pressures, refer to "Tires and wheels" on page 8-25.

⚠ WARNING**Tire tread**

Always check the tire tread before driving your vehicle. Worn-out tires can result in loss of vehicle control. Worn-out tires should be replaced as soon as possible. For further information and tread limits, refer to "Tires and wheels" on page 8-25.

Winter driving

Severe weather conditions in the winter result in greater wear and other problems.

To minimize the problems of winter driving, you should follow these suggestions:

Snowy or icy conditions

To drive your vehicle in deep snow, it may be necessary to use snow tires or to install tire chains on your tires.

If snow tires are needed, it is necessary to select tires equivalent in size and type of the original equipment tires. Failure to do so may adversely affect the safety and handling of your vehicle. Furthermore, speeding, rapid acceleration, sudden brake applications, and sharp turns are potentially very hazardous practices.

During deceleration, use vehicle braking to the fullest extent. Sudden brake applications on snowy or icy roads may cause skids to occur. You need to keep sufficient distance between the vehicle in operation in front of your vehicle. Also, apply the brake gently. It should be noted that installing tire chains on the tire will provide a greater driving force, but will not prevent side skids.

Tire chains are not legal in all states. Check state laws before fitting tire chains.

Snow tires

If you mount snow tires on your vehicle, make sure they are radial tires of the same size and load range as the original tires. Mount snow tires on all four wheels to balance your vehicle's handling in all weather conditions. Keep in mind that the traction provided by snow tires on dry roads may not be as high as your vehicle's original equipment tires. You should drive cautiously even when the roads are clear. Check with the tire dealer for maximum speed recommendations.

Do not install studded tires without first checking local, state and municipal regulations for possible restrictions against their use.

⚠ WARNING

Snow tire size

Snow tires should be equivalent in size and type to the vehicle's standard tires. Otherwise, the safety and handling of your vehicle may be adversely affected.

Tire chains

When using tire chains, install tire chains only on the front tires.



Since the sidewalls of radial tires are thinner, they can be damaged by mounting some types of snow chains on them. Therefore, the use of snow tires is recommended instead of snow chains. Do not mount tire chains on vehicles equipped with aluminum wheels; snow chains may cause damage to the wheels. If snow chains must be used, use wire-type chains with a thickness of less than 0.47 in (12 mm). Damage to your vehicle caused by improper snow chain use is not covered by your vehicle manufacturer's warranty.

Install tire chains only on the front tires.

Always check chain installation for proper mounting after driving approximately 0.3 to 0.6 miles (0.5 to 1 km) to ensure safe mounting.

Retighten or remount the chains if they are loose.

Chain installation

When installing chains, follow the manufacturer's instructions and mount them as tightly possible. Make sure the snow chains are SAE class "S" certified. Drive slowly (less than 20 mph (30 km/h)) with chains installed. If you hear the chains contacting the body or chassis, stop and tighten them. If they still make contact, slow down until it stops. Remove the chains as soon as you begin driving on cleared roads. When mounting snow chains, park the vehicle on level ground away from traffic. Turn on the vehicle Hazard Warning flashers and place a triangular emergency warning device behind the vehicle if available. Always place the vehicle in P (Park), apply the parking brake and turn off the vehicle before installing snow chains.

- The use of chains may adversely affect vehicle handling.
- Do not exceed 20 mph (30 km/h) or the chain manufacturer's recommended speed limit, whichever is lower.
- Drive carefully and avoid bumps, holes, sharp turns, and other road hazards, which may cause the vehicle to bounce.
- Avoid sharp turns or locked-wheel braking.

⚠ CAUTION

Snow chains

- Chains that are the wrong size or improperly installed can damage your vehicle's brake lines, suspension, body and wheels.
- Stop driving and retighten the chains any time you hear them hitting the vehicle.

Use high quality ethylene glycol coolant

Your vehicle is delivered with high quality ethylene glycol coolant in the cooling system. It is the only type of coolant that should be used because it helps prevent corrosion in the cooling system, lubricates the water pump and prevents freezing. Be sure to replace or replenish your coolant refer to "Normal maintenance schedule – Non Turbo Models" on page 8-10. Before winter, have your coolant tested to assure that its freezing point is sufficient for the temperatures anticipated during the winter.

Check battery and cables

Winter puts additional burdens on the battery system. Visually inspect the battery and cables (refer to "For best battery service" on page 8-23). The level of charge in your battery can be checked by an authorized Kia dealer or a service station.

Change to "winter weight" oil if necessary

In some climates it is recommended that a lower viscosity "winter weight" oil be used during cold weather. Refer to "Recommended lubricants and capacities" on page 9-5 for recommendations. If you aren't sure what weight oil you should use, consult an authorized Kia dealer.

To keep locks from freezing

To keep the locks from freezing, squirt an approved de-icer fluid or glycerine into the key opening. If a lock is covered with ice, squirt it with an approved de-icing fluid to remove the ice. If the lock is frozen internally, you may be able to thaw it out by using a heated key. Handle the heated key with care to avoid injury.

Use approved window washer anti-freeze in system

To keep the water in the window washer system from freezing, add an approved window washer anti-freeze solution in accordance with instructions on the container. Window washer anti-freeze is available from an authorized Kia dealer and most auto parts outlets. Do not use vehicle coolant or other types of anti-freeze as these may damage the paint finish.

Don't let your parking brake freeze

Under some conditions your parking brake can freeze in the engaged position. This is most likely to happen when there is an accumulation of snow or ice around or near the rear brakes or if the brakes are wet. If there is a risk the parking brake may freeze, apply it only temporarily while you put the gear shift dial in P (Park) and block the rear wheels so the vehicle cannot roll. Then release the parking brake.

Don't let ice and snow accumulate underneath

Under some conditions, snow and ice can build up under the fenders and interfere with the steering. When driving in severe winter conditions where this may happen, you should periodically check underneath the vehicle to be sure the movement of the front wheels and the steering components are not obstructed.

Carry emergency equipment

Depending on the severity of the weather, you should carry appropriate emergency equipment. Some of the items you may want to carry include tow straps or chains, flashlight, emergency flares, sand, shovel, jumper cables, window scraper, gloves, ground cloth, coveralls, blanket, etc.

Trailer towing

We do not recommend using this vehicle for trailer towing.

Vehicle load limit

The vehicle load limit is displayed on the tire and loading information label on the driver's door.

Tire and loading information label

The label located on the driver's door sill gives the original tire size, cold tire pressures recommended for your vehicle, the number of people that can be in your vehicle and vehicle capacity weight.

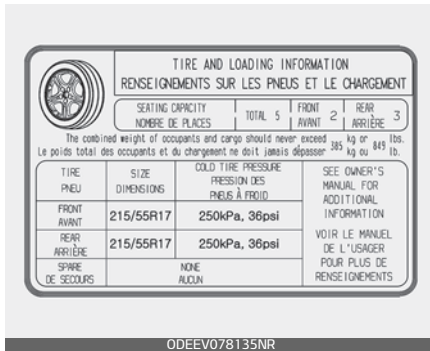

Vehicle capacity weight:

849 lbs. (385 kg)

Vehicle capacity weight is the maximum combined weight of occupants and cargo. If your vehicle is equipped with a trailer, the combined weight includes the tongue load.

Seating capacity:

Total: 5 persons (Front seat: 2 persons, Rear seat: 3 persons)

Seating capacity is the maximum number of occupants including a driver, your vehicle may carry.

However, the seating capacity may be reduced based upon the weight of all of the occupants, and the weight of the cargo being carried or towed.

Do not overload the vehicle as there is a limit to the total weight, or load limit including occupants and cargo, the vehicle can carry.

Towing capacity:

We do not recommend using this vehicle for trailer towing.

Cargo capacity:

The cargo capacity of your vehicle will increase or decrease depending on the weight and the number of occupants.

Steps For Determining Correct Load Limit –

1. Locate the statement "The combined weight of occupants and cargo should never exceed XXX kg or XXX lbs." on your vehicle's placard.
2. Determine the combined weight of the driver and passengers that will be riding in your vehicle.
3. Subtract the combined weight of the driver and passengers from XXX kg or XXX lbs.

4. The resulting figure equals the available amount of cargo and luggage load capacity. For example, if the "XXX" amount equals 1400 lbs. and there will be five 150 lb passengers in your vehicle, the amount of available cargo and luggage load capacity is 650 lbs. (1400-750 (5 x 150) = 650 lbs.)
5. Determine the combined weight of luggage and cargo being loaded on the vehicle. That weight may not safely exceed the available cargo and luggage load capacity calculated in Step 4.
6. If your vehicle will be towing a trailer, load from your trailer will be transferred to your vehicle. Consult this manual to determine how this reduces the available cargo and luggage load capacity of your vehicle.

Example 1

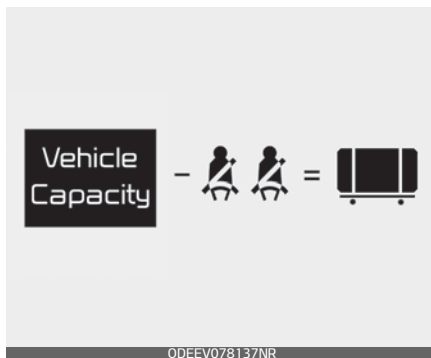

Item	Description	Total
A	Vehicle Capacity Weight	849 lbs. (385 kg)
B	Subtract Occupant Weight 150 lbs. (68 kg) x 2	300 lbs. (136 kg)
C	Available Cargo and Luggage weight	549 lbs. (249 kg)

Example 2

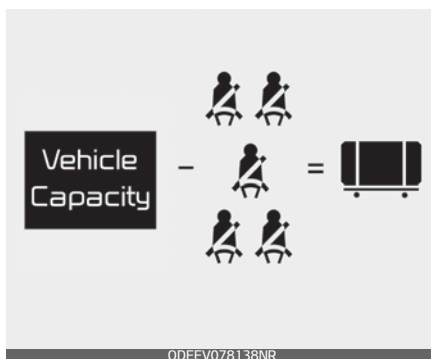

⚠ WARNING

Loose cargo

Do not travel with unsecured blunt objects in the passenger compartment of your vehicle (e.g. suit cases or unsecured child seats). These items may strike occupant during a sudden stop or crash.

Item	Description	Total
A	Vehicle Capacity Weight	849 lbs. (385 kg)
B	Subtract Occupant Weight 150 lbs. (68 kg) × 5	750 lbs. (340 kg)
C	Available Cargo and Luggage weight	99 lbs. (45 kg)

Example 3

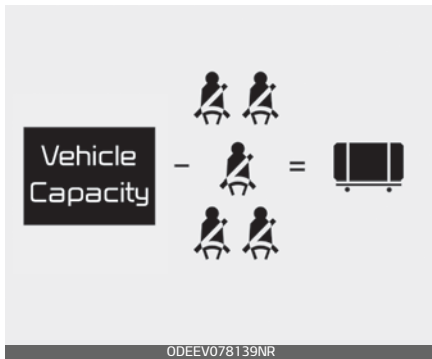

Item	Description	Total
A	Vehicle Capacity Weight	849 lbs. (385 kg)
B	Subtract Occupant Weight 161 lbs. (73 kg) × 5	805 lbs. (365 kg)
C	Available Cargo and Luggage weight	44 lbs. (20 kg)

Refer to your vehicle's tire and load-
ing information label for specific
information about your vehicle's
capacity weight and seating posi-
tions. The combined weight of the
driver, passengers and cargo should
never exceed your vehicle's capac-
ity weight.

Certification label

The certification label is located on
the driver's door sill at the center
pillar.



This label shows the maximum
allowable weight of the fully loaded
vehicle. This is called the GVWR
(Gross Vehicle Weight Rating). The
GVWR includes the weight of the
vehicle, all occupants and cargo.

This label also tells you the maxi-
mum weight that can be supported
by the front and rear axles, called
Gross Axle Weight Rating (GAWR).

To find out the actual loads on your front and rear axles, you need to go to a weigh station and weigh your vehicle. Your dealer can help you with this. Be sure to spread out your load equally on both sides of the centerline.

⚠ WARNING**Over loading**

Never exceed the GVWR for your vehicle, the GAWR for either the front or rear axle and vehicle capacity weight. Exceeding these ratings can affect your vehicle's handling and braking ability.

The label will help you decide how much cargo and installed equipment your vehicle can carry.

If you carry items inside your vehicle – like suitcases, tools, packages, or anything else – they are moving as fast as the vehicle. If you have to stop or turn quickly, or if there is a crash, the items will keep going and can cause an injury if they strike the driver or a passenger.

⚠ WARNING**Over loading**

Do not overload your vehicle. Overloading your vehicle can cause heat buildup in your vehicle's tires and possible tire failure, increased stopping distances and poor vehicle handling—all of which may result in a crash.

*** NOTICE**

Overloading your vehicle may cause damage. Repairs would not be covered by your warranty. Do not overload your vehicle.

Vehicle weight

This chapter will guide you in the proper loading of your vehicle and/or trailer, to keep your loaded vehicle weight within its design rating capability, with or without a trailer.

Properly loading your vehicle will provide maximum return of the vehicle design performance. Before loading your vehicle, familiarize yourself with the following terms for determining your vehicle's weight ratings, with or without a trailer, from the vehicle's specifications and the compliance label:

Base curb weight This is the weight of the vehicle including a full tank of fuel and all standard equipment. It does not include passengers, cargo, or optional equipment.

Vehicle curb weight This is the weight of your new vehicle when you picked it up from your dealer plus any aftermarket equipment.

Cargo weight This figure includes all weight added to the Base Curb Weight, including cargo and optional equipment.

GAW (Gross axle weight) This is the total weight placed on each axle (front and rear) - including vehicle curb weight and all payload.

GAWR (Gross axle weight rating)

This is the maximum allowable weight that can be carried by a single axle (front or rear). These numbers are shown on the compliance label. The total load on each axle must never exceed its GAWR.

GVW (Gross vehicle weight) This is the Base Curb Weight plus actual Cargo Weight plus passengers.

GVWR (Gross vehicle weight rating)

This is the maximum allowable weight of the fully loaded vehicle (including all options, equipment, passengers and cargo). The GVWR is shown on the certification label located on the driver's door sill.

Road warning	7-3
• Hazard warning flasher	7-3
In case of an emergency while driving	7-4
• If the Vehicle Stalls While Driving	7-4
• If the Vehicle Stalls at a crossroad or crossing	7-4
• If you have a flat tire while driving.....	7-4
If the vehicle will not start	7-5
Emergency starting	7-5
• Jump starting	7-5
• Push-starting.....	7-7
If the vehicle overheats	7-8
Tire Pressure Monitoring System (TPMS)	7-9
• Effective Use of the Tire Pressure Monitoring System (TPMS)	7-10
• Low tire pressure telltale	7-12
• Low tire pressure position telltale.....	7-12
• Tire Pressure Monitoring System (TPMS) malfunction indicator	7-13
• Tire replacement with TPMS.....	7-14
• This device complies with Part 15 of the FCC rules.	7-15
If you have a flat tire (with Tire Mobility Kit)	7-16
• Components of the Tire Mobility Kit.....	7-19
• Using the Tire Mobility Kit	7-20
• Distributing the sealant	7-22
• Checking the tire inflation pressure	7-22
• Technical data	7-24

7 What to do in an emergency

Towing	7-24
• Towing without Wheel Dollies when using a Towing Service	7-25
• Using removable towing hook	7-26
• Emergency towing	7-26
If an accident occurs	7-29

WHAT TO DO IN AN EMERGENCY

Road warning

When an emergency situation occurs while driving or when you park by the edge of the roadway, you must alert approaching or passing vehicles to be careful as they pass. For this, you should use the hazard warning flasher.

Hazard warning flasher

The hazard warning flasher serves as a warning to other drivers to exercise extreme caution when approaching, overtaking, or passing your vehicle.

Depress the flasher switch with the POWER button in any position. The flasher switch is located in the center fascia panel. All turn signal lights will flash simultaneously.

- The hazard warning flasher operates whether your vehicle is running or not.
- The turn signals do not work when the hazard flasher is on.
- Care must be taken when using the hazard warning flasher while the vehicle is being towed.



ODEEV088001NR

It should be used whenever emergency repairs are being made or when the vehicle is stopped near the edge of a roadway.

In case of an emergency while driving

If an emergency situation occurs while driving, stay calm and take the following steps.

If the Vehicle Stalls While Driving

1. Reduce your speed gradually, keeping a straight line.
2. Move cautiously off the road to a safe place.
3. Turn on your hazard warning flasher.
4. Try to start the vehicle again. If your vehicle will not start, contact an authorized Kia dealer or seek other qualified assistance.

If the Vehicle Stalls at a crossroad or crossing

1. If safe to do so, shift to the N (Neutral) position.
2. Push the vehicle to a safe location.

If you have a flat tire while driving

- Take your foot off the accelerator pedal and let the vehicle slow down while driving straight ahead.

⚠ WARNING

Do not apply the brakes immediately to slow down the vehicle

- Use the paddle shifter (left side lever) to increase regenerative braking control.

⚠ WARNING

Do not or attempt to pull off the road as this may cause loss of vehicle control resulting in an accident.

- When the vehicle has slowed to such a speed that it is safe to do so, brake carefully and pull off the road.
- Drive off the road as far as possible and park on firm, level ground.

⚠ WARNING

If you are on a divided highway, do not park in the median area between the two traffic lanes.

- When the vehicle is stopped, press the hazard warning flasher button, shift to P (Park), apply the parking brake, and place the POWER button in the OFF position.
- Have all passengers get out of the vehicle. Be sure they all get out on the side of the vehicle that is away from traffic.
- Follow the instructions provided later in this chapter.

If the vehicle will not start

The vehicle may not start if the battery level is low.

Check the battery level by performing the following procedure.

1. Be sure the shifter dial is in P (Park). The vehicle starts only when the shifter dial is in P (Park).
2. Check the 12-volt battery connections to be sure they are clean and tight.
3. Turn on the interior light. If the light dims or goes out when you operate the starter, the battery is drained.

WARNING

Do not push or pull the vehicle to start it. This could cause damage to your vehicle.

Emergency starting

When the vehicle will not start because of low battery power, you may need to jump start the vehicle.

Jump starting

Connect cables in numerical order and disconnect in reverse order.

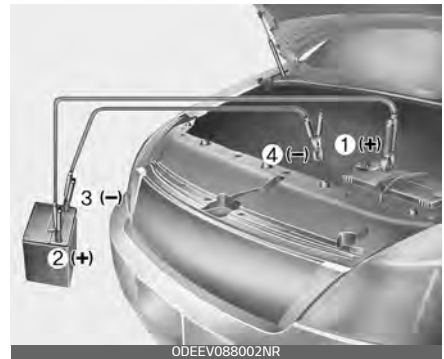

Jump starting can be dangerous if done incorrectly. Therefore, to avoid harm to yourself or damage to your vehicle or battery, follow these jump starting procedures. If in doubt, we strongly recommend that you have a competent technician or towing service jump start your vehicle.

WARNING

Battery

Never attempt to check the electrolyte level of the battery as this may cause the battery to rupture or explode.

⚠ WARNING**Frozen batteries**

Do not attempt to jump start the vehicle if the discharged battery is frozen as the battery may rupture or explode.

⚠ WARNING**Electrolyte**

- Do not charge or discharge the battery arbitrarily. It may lead to fault, electric shock or burns.
 - Do not damage the battery in such ways as drop, deform, impact, out or spear with a sharp object. It may cause electrolyte leakage or fire.
 - Breakdown of the battery may lead to electrolyte leakage or flammable gas generation. Contact an authorized Kia dealer immediately.
 - If electrolyte leaks out, avoid contact with eyes, skin or clothes. In event of accident, flush with water and get medical help immediately.
 - Do not place the battery near open flame or incinerate. It may lead to fire or explosion.
 - Keep out of reach of children or animals.
 - Keep the battery away from moisture of liquid. Do not touch or use if liquids have been spilled on.
-

⚠ WARNING**Battery cables**

Do not connect the jumper cable from the negative terminal of the booster battery to the negative terminal of the discharged battery, directly. This can cause the discharged battery to overheat and crack, degradation.

Connect the jumper cable from the negative terminal of the booster battery to the chassis ground in the motor room.

⚠ WARNING**Sulfuric acid risk**

Automobile batteries contain sulfuric acid. When jump starting your vehicle, be careful not to get sulfuric acid on yourself, your clothing, or on the vehicle. This acid is poisonous and highly corrosive.

⚠ WARNING**Battery**

Keep all flames or sparks away from the battery. The battery produces hydrogen gas which will explode if exposed to flame or sparks.

Jump-starting

1. Make sure the booster battery is 12-volt and that its negative terminal is grounded.
2. If the booster battery is in another vehicle, do not allow the vehicles to come in contact.
3. Turn off all unnecessary electrical loads.
4. Connect the jumper cables in the exact sequence shown in the illustration. First connect one end of a jumper cable to the positive terminal of the discharged battery (1), then connect the other end to the positive terminal of the booster battery (2).
Proceed to connect one end of the other jumper cable to the negative terminal of the booster battery (3), then the other end to a solid, stationary, metallic point away from the battery (4).
Do not allow the jumper cables to contact anything except the correct battery terminals or the correct ground. Do not lean over the battery when making connections.
5. Start vehicle with the booster battery and let it run, then start the vehicle with the discharged battery.

If the cause of your battery discharging is not apparent, you should have your vehicle checked by an authorized Kia dealer.

*** NOTICE**

Make sure to connect one end of the jumper cable to the negative terminal of the booster battery, and the other end to a metallic point, far away from the battery.

Push-starting

Your vehicle equipped with reduction gear should not be push-started.

⚠ WARNING**Tow starting vehicle**

Never tow a vehicle to start it.

When the vehicle starts, the vehicle can suddenly surge forward and could cause a collision with the tow vehicle.

If the vehicle overheats

1. Pull off the road and stop as soon as it is safe to do so.
2. Shift to P (Park) and set the parking brake.
3. If the air conditioning is on, turn it off.
4. Depending on whether the coolant or steam escapes from the hood, do the following:
 - If coolant is running out under the vehicle or steam is coming out from the hood, stop the vehicle.

⚠ WARNING

Do not open the hood until the coolant has stopped running or the steaming has stopped.

- If there is no visible loss of coolant and no steam, leave the vehicle running and check to be sure the vehicle cooling fan is operating. If the fan is not running, turn the vehicle off.
5. Check for coolant leaking from the radiator, hoses or under the vehicle. (If the air conditioning had been in use, it is normal for cold water to be draining from it when you stop.)

⚠ WARNING

Radiator Cap



While the vehicle is running, keep hands, clothing and tools away from the moving parts such as the cooling fan to prevent serious injury.

6. If coolant is leaking out, stop the vehicle immediately and call the nearest authorized Kia dealer for assistance.
7. If you cannot find the cause of the overheating, wait until the radiator temperature has returned to normal. Then, if coolant has been lost, carefully add coolant to the reservoir to bring the fluid level in the reservoir up to the halfway mark.
8. Proceed with caution, keeping alert for further signs of overheating. If overheating happens again, call an authorized Kia dealer for assistance.

⚠ WARNING



Your vehicle is equipped with a pressurized coolant reserve tank. NEVER remove the coolant reserve tank cap or the radiator drain plug while the radiator is HOT. Hot coolant and steam may blow out under pressure, causing serious injury.

Turn the vehicle off and wait until the vehicle cools down. Use extreme care when removing the coolant reserve tank cap. Wrap a towel or thick rag around it, and turn it counterclockwise slowly to release some of the pressure from the system. Step back while the pressure is released.

When you are sure all the pressure has been released, continue turning the cap counterclockwise to remove it.

⚠ CAUTION

Serious loss of coolant indicates a leak in the cooling system and should be checked as soon as possible by an authorized Kia dealer.

Tire Pressure Monitoring System (TPMS)

The tire pressure monitoring system detects the pressure of vehicle's tires and displays it on the LCD display.



ODEEV088005NR



ODEEV068092NR

1. Low tire pressure telltale / TPMS malfunction indicator
2. Low tire pressure position telltale (Shown on the LCD display)

Tire Pressure Indicator

- You can check the tire pressure in the assist mode on the cluster.
 - Refer to "User settings mode" on page 5-56.
- Tire pressure is displayed 1~2 minutes later after driving.
- If tire pressure is not displayed when the vehicle is stopped, "Drive to display" message displays. After driving, check the tire pressure.
- You can change the tire pressure unit in the user settings mode on the cluster.
 - psi, kPa, bar (Refer to "User settings mode" on page 5-56).

* NOTICE

- The tire pressure may change due to factors such as parking condition, driving style, and altitude above sea level.
- Low tire pressure warning may sound when a tire's pressure unit is equal or higher than nearby tires. This is a normal occurrence, which is due to the change in tire pressure along with tire temperature.
- The tire pressure shown on the dashboard may differ from the tire pressure measured by tire pressure gauge.

Effective Use of the Tire Pressure Monitoring System (TPMS)

Each tire, including the spare (if provided), should be checked monthly when cold and inflated to the inflation pressure recommended by the vehicle manufacturer on the vehicle placard or tire inflation pressure label.

(If your vehicle has tires of a different size than the size indicated on the vehicle placard or tire inflation pressure label, you should determine the proper tire inflation pressure for those tires.)

As an added safety feature, your vehicle has been equipped with a tire pressure monitoring system (TPMS) that illuminates a low tire pressure telltale when one or more of your tires is significantly under-inflated. Accordingly, when the low tire pressure telltale illuminates, you should stop and check your tires as soon as possible, and inflate them to the proper pressure. Driving on a significantly under-inflated tire causes the tire to overheat and can lead to tire failure. Under-inflation also reduces fuel efficiency and tire tread life, and may affect the vehicle's handling and stopping ability.

Please note that the TPMS is not a substitute for proper tire maintenance, and it is the driver's responsibility to maintain correct tire pressure, even if under-inflation has not reached the level to trigger illumination of the TPMS low tire pressure telltale.

Your vehicle has also been equipped with a TPMS malfunction indicator to indicate when the system is not operating properly. The TPMS malfunction indicator is combined with the low tire pressure telltale. When the system detects a malfunction, the telltale will flash for approximately one minute and then remain continuously illuminated. This sequence will continue upon subsequent vehicle start-ups as long as the malfunction exists. When the malfunction indicator is illuminated, the system may not be able to detect or signal low tire pressure as intended. TPMS malfunctions may occur for a variety of reasons, including the installation of replacement or alternate tires or wheels on the vehicle that prevent the TPMS from functioning properly.

Always check the TPMS malfunction telltale after replacing one or more tires or wheels on your vehicle to ensure that the replacement or alternate tires and wheels allow the TPMS to continue to function properly.

* NOTICE

If any of the below happens, have the system checked by an authorized Kia dealer.

1. The Low Tire Pressure TPMS Malfunction Indicator does not illuminate for 3 seconds when the POWER button is placed to the ON position or vehicle is ON ( indicator ON).
2. The TPMS Malfunction Indicator remains illuminated after blinking for approximately 1 minute.
3. The Low Tire Pressure LCD display remains illuminated.

Low tire pressure telltale

Low tire pressure position telltale

When the tire pressure monitoring system warning indicators are illuminated, one or more of your tires is significantly under-inflated.



If the telltale illuminates, immediately reduce your speed, avoid hard cornering and anticipate increased stopping distances. You should stop and check your tires as soon as possible.

Inflate the tires to the proper pressure as indicated on the vehicle's placard or tire inflation pressure label located on the driver's side center pillar outer panel. If you cannot reach a service station or if the tire cannot hold the newly added air, replace the low pressure tire with the spare tire.

Then the TPMS malfunction indicator and the Low Tire Pressure telltale may turn on and illuminate after restarting and about 20 minutes of continuous driving before you have the low pressure tire repaired and replaced on the vehicle.

In winter or cold weather, the low tire pressure telltale may be illuminated if the tire pressure was adjusted to the recommended tire inflation pressure in warm weather. It does not mean your TPMS is malfunctioning because the decreased temperature leads to a proportional lowering of tire pressure.

When you drive your vehicle from a warm area to a cold area or from a cold area to a warm area, or the outside temperature is greatly higher or lower, you should check the tire inflation pressure and adjust the tires to the recommended tire inflation pressure.

When filling tires with more air, conditions to turn off the low tire pressure telltale may not be met. This is because a tire inflator has a margin of error in performance. The low tire pressure telltale will be turned off if the tire pressure is above the recommended tire inflation pressure.

⚠ WARNING**Low pressure damage**

Do not drive on low pressure tires. Significantly low tire pressure can cause the tires to overheat and fail making the vehicle unstable resulting in increased braking distances and a loss of vehicle control.

Tire Pressure Monitoring System (TPMS) malfunction indicator 

The low tire pressure telltale will illuminate after it blinks for approximately one minute when there is a problem with the Tire Pressure Monitoring System.

If the system is able to correctly detect an underinflation warning at the same time as system failure then it will illuminate both the TPMS malfunction and low tire pressure position telltales e.g. if Front Left sensor fails, the TPMS malfunction indicator illuminates, but if the Front Right, Rear Left, or Rear Right tire is under-inflated, the low tire pressure position telltales may illuminate together with the TPMS malfunction indicator.

Have the system checked by an authorized Kia dealer as soon as possible to determine the cause of the problem.

- The TPMS malfunction indicator may be illuminated if the vehicle is moving around electric power supply cables or radios transmitters such as at police stations, government and public offices, broadcasting stations, military installations, airports, or transmitting towers, etc. This can interfere with normal operation of the Tire Pressure Monitoring System (TPMS).
- The TPMS malfunction indicator may be illuminated if snow chains are used or some separate electronic devices such as notebook computer, mobile charger, remote starter or navigation etc., are used in the vehicle. This can interfere with normal operation of the Tire Pressure Monitoring System (TPMS).

Tire replacement with TPMS

If you have a flat tire, the Low Tire Pressure telltale will come on. Have the flat tire repaired by an authorized Kia dealer as soon as possible or replace the flat tire with the spare tire.

CAUTION

Repair Agents

Never use a puncture-repairing agent not approved by Kia to repair and/or inflate a low pressure tire. The sealant not approved by Kia may damage the tire pressure sensor.

Each wheel is equipped with a tire pressure sensor mounted inside the tire behind the valve stem. You must use TPMS specific wheels. It is recommended that you always have your tires serviced by an authorized Kia dealer.

Even if you replace the low pressure tire with the spare tire, the Low Tire Pressure telltale will remain on until the low pressure tire is repaired and placed on the vehicle.

After you replace the low pressure tire with the spare tire, the TPMS malfunction indicator may illuminate after a few minutes because the TPMS sensor mounted on the spare wheel is not initiated.

Once the low pressure tire is inflated again to the recommended pressure and installed on the vehicle or the TPMS sensor mounted on the replaced spare wheel is initiated by an authorized Kia dealer, the TPMS malfunction indicator and the low tire pressure telltale will turn off within a few minutes of driving.

If the indicator has not disappeared after a few minutes of driving, please visit an authorized Kia dealer.

If an original mounted tire is replaced with the spare tire, the TPMS sensor on the replaced spare wheel should be initiated and the TPMS sensor on the original mounted wheel should be deactivated. If the TPMS sensor on the original mounted wheel located in the spare tire carrier still activates, the tire pressure monitoring system may not operate properly. Have the tire with TPMS serviced or replaced by an authorized Kia dealer.

You may not be able to identify a low tire by simply looking at it. Always use a good quality tire pressure gauge to measure the tire's inflation pressure. Please note that a tire that is hot (from being driven) will have a higher pressure measurement than a tire that is cold (from sitting stationary for at least 3 hours and driven less than 1 mile (1.6 km) during that 3 hour period).

Allow the tire to cool before measuring the inflation pressure. Always be sure the tire is cold before inflating to the recommended pressure.

A cold tire means the vehicle has been sitting for 3 hours and driven for less than 1 mile (1.6 km) in that 3 hour period.

Never use tire sealant if your vehicle is equipped with a Tire Pressure Monitoring System. The liquid sealant can damage the tire pressure sensors.

- The TPMS cannot alert you to severe and sudden tire damage caused by external factors such as nails or road debris.
- If you feel any vehicle instability, immediately take your foot off the accelerator, apply the brakes gradually and with light force, and slowly move to a safe position off the road.

* NOTICE

Protecting TPMS

Tampering with, modifying, or disabling the Tire Pressure Monitoring System (TPMS) components may interfere with the system's ability to warn the driver of low tire pressure conditions and/or TPMS malfunctions. Tampering with, modifying, or disabling the Tire Pressure Monitoring System (TPMS) components may void the warranty for that portion of the vehicle.

This device complies with Part 15 of the FCC rules.

Operation is subject to the following two conditions:

1. This device may not cause harmful interference, and
2. This device must accept any interference received, including interference that may cause undesired operation.
3. Changes or modifications not expressly approved by the party responsible for compliance could void the user's authority to operate the device.

If you have a flat tire (with Tire Mobility Kit)

The Tire Mobility Kit is a temporary fix to the tire and the tire should be inspected by an authorized Kia dealer as soon as possible.



ODEEV088008NR

1. Compressor
2. Sealant bottle

For safe operation, carefully read and follow the instructions in this manual before use.

⚠ CAUTION

When two or more tires are flat, do not use the tire mobility kit because the one supplied canister of sealant in the Tire Mobility Kit is to only enough sealant for one flat tire.

⚠ WARNING

Tire wall

Do not use the Tire Mobility Kit to repair large punctures or damage to the tire sidewalls. In these situations, the tire cannot be sealed completely and air will leak from the tire. This can result in tire failure.

⚠ WARNING

Have your tire repaired as soon as possible. The tire may lose air pressure at any time after inflating with the Tire Mobility Kit.

⚠ WARNING

Speed with temporary fix

Do not exceed a speed of 50 mph (80 km/h) when driving with a tire sealed with the Tire Mobility Kit. While driving, if you experience any unusual vibration, ride disturbance, or noise, reduce your speed and drive with caution until you can safely pull off to the side of the road.

Introduction

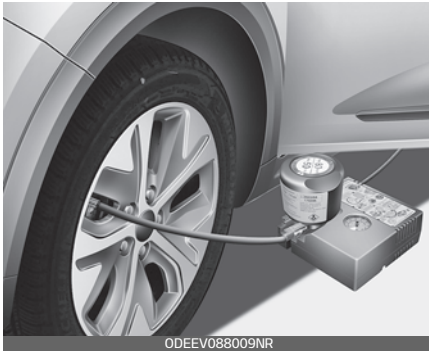

With the Tire Mobility Kit you stay mobile even after experiencing a tire puncture.

The system of compressor and sealing compound effectively seals most punctures in a passenger car tire caused by nails or similar objects and reinflates the tire.

After you ensured that the tire is properly sealed you can drive cautiously on the tire at a max. speed of 50 mph (80 km/h) in order to reach a service station or tire dealer to have the tire replaced as soon as possible.

It is possible that some tires, especially with larger punctures or damage to the sidewall, cannot be sealed completely.

Air pressure loss in the tire may adversely affect tire performance.

For this reason, you should avoid abrupt steering or other driving maneuvers, especially if the vehicle

is heavily loaded or if a trailer is in use.

The Tire Mobility Kit is not designed or intended as a permanent tire repair method and is to be used for one tire only.

This instruction shows you step by step procedure to temporarily seal the puncture.

Read the section "Notes on the safe use of the Tire Mobility Kit".

Notes on the safe use of the Tire Mobility Kit

- Park your car at the side of the road so that you can work with the Tire Mobility Kit away from moving traffic.
- To be sure your vehicle will not move, even when you're on fairly level ground, always set your parking brake.
- Only use the Tire Mobility Kit for sealing/inflation passenger car tires. Only punctured areas located within the tread region of the tire can be sealed using the Tire Mobility Kit.
- Do not use on motorcycles, bicycles or any other type of tires.
- When the tire and wheel are damaged, do not use Tire Mobility Kit for your safety.
- Use of the Tire Mobility Kit may not be effective for tire damage

larger than approximately 0.16 in (4 mm).

Please contact the nearest Kia dealership if the tire cannot be made roadworthy with the Tire Mobility Kit.

- Do not use the Tire Mobility Kit if a tire is severely damaged by driving run flat or with insufficient air pressure.
- Do not remove any foreign objects such as nails or screws that have penetrated the tire.
- Provided the car is outdoors, leave the vehicle ON (🚗 indicator ON). Otherwise operating the compressor may eventually drain the car battery.
- Never leave the Tire Mobility Kit unattended while it is being used.
- Do not leave the compressor running for more than 10 min. at a time or it may overheat.
- Do not use the Tire Mobility Kit if the ambient temperature is below -22 °F (-30 °C).

⚠ CAUTION

When repairing a flat tire with the Tire Mobility Kit (TMK), quickly remove the sealant on the tire pressure sensor and wheel. When installing the repaired tire and wheel, tighten the wheel nut to a torque value of 79~94 lbf·ft (11~13 kgf·m).

⚠ WARNING

Sealant

- Keep out of reach of children.
- Avoid contact with eyes.
- Do not swallow.

⚠ WARNING

Do not use the Tire sealant after the sealant has expired (i.e. past the expiration date on the sealant container). This can increase the risk of tire failure.

⚠ WARNING

- If the sealant gets on your skin, wash it with a large amount of water. If skin irritation continues, visit a doctor for examination.
- If the sealant gets into your eyes, raise your eyelid and wash for at least 15 minutes. If eye irritation continues, visit a doctor for examination.
- If you swallowed the sealant, wash the mouth and drink a large amount of water. However, do not give anything to an unconscious person and see the doctor immediately. Exposure to the sealant for a long time may cause damage to the bodily tissues.

Components of the Tire Mobility Kit

Connectors, cable and connection hose are stored in the compressor housing.

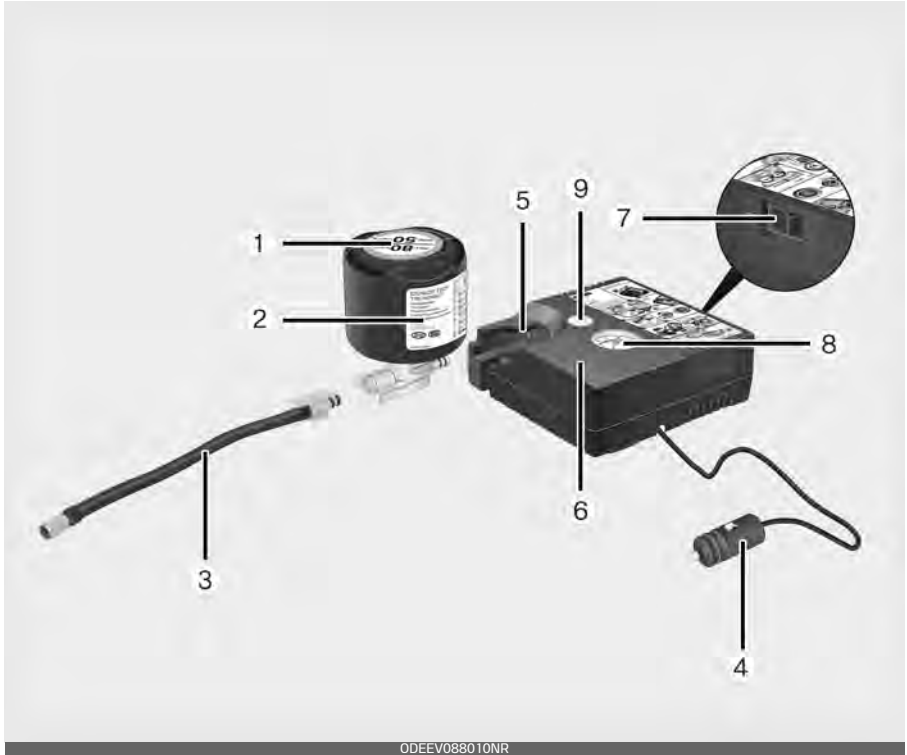

1. Speed restriction label
2. Sealant bottle and label with speed restriction
3. Filling hose from sealant bottle to wheel
4. Connectors and cable for the power outlet direct connection
5. Holder for the sealant bottle
6. Compressor
7. On/off switch
8. Pressure gauge for displaying the tire inflation pressure
9. Button for reducing tire inflation pressure

⚠ WARNING

Before using the Tire Mobility Kit, follow the instructions on the sealant bottle.

Remove the label with the speed restriction from the sealant bottle and apply it to the steering wheel. Please note the expiry date on the sealant bottle.

*** NOTICE**

The sealant container and insert hose (3) cannot be reused.

⚠ CAUTION

Before using the tire repair kit, please read carefully the instruction attached on the sealant bottle. Detach the speed limit label on the sealant case and put it on a highly visible place. Always drive within the speed limit.

ODEEV088011NR

Using the Tire Mobility Kit

Carefully follow below steps.

1. Shake the sealant bottle.



ODEEV088012NR

2. Connect the filling hose (3) onto the connector of the sealant bottle (2).



ODEEV088013NR

3. Ensure that button (9) on the compressor is not pressed.
4. Unscrew the valve cap from the valve of the defective wheel and screw filling hose (3) of the sealant bottle onto the valve.



ODEEV088014NR

5. Insert the sealant bottle into the housing of the compressor (5) so that the bottle is upright.

*** NOTICE**

If a visible foreign object has punctured the tire, do not remove it before using Tire Mobility Kit.

*** NOTICE**



ODEEV088015NR

If the sealant is injected when the tire air pressure injection valve and sealant injection hose are not fully interlocked, the sealant may overflow and clog the valve.

6. Ensure that the compressor is switched off, position 0.



ODEEV088016NR

7. Connect between compressor and the vehicle power outlet (4) using the cable and connectors.

8. With the POWER button ON, switch on the compressor and let it run for approximately 5~7 minutes to fill the sealant up to cold tire recommended pressure. (refer to "Tires and wheels" on page 8-25). The inflation pressure of the tire after filling is unimportant and will be checked/corrected later. Be careful not to overinflate the tire and stay away from the tire when filling it.

⚠ WARNING

Tire pressure

Do not attempt to drive your vehicle if the tire pressure is below 29 psi (200 kPa). This could result in an accident due to sudden tire failure.

9. Switch off the compressor.

10. Detach the hoses from the sealant bottle connector and from the tire valve.
11. Return the Tire Mobility Kit to its storage location in the vehicle.

⚠ WARNING

Carbon monoxide

Carbon monoxide poisoning and suffocation is possible if the vehicle is left running in a poorly ventilated or unventilated location (such as inside a building).

Distributing the sealant

After putting sealant into the tire, it is necessary to drive the vehicle so that the sealant becomes evenly distributed inside the tire.



ODEEV088017NR

- Immediately drive approximately 4~6 miles (7~10 km or, about 10 min) to evenly distribute the sealant in the tire.

Do not exceed a speed of 50 mph (80 km/h). If possible, do not fall below a speed of 12 mph (20 km/h).

While driving, if you experience any unusual vibration, ride disturbance or noise, reduce your speed and drive with caution until you can safely pull off of the side of the road.

⚠ CAUTION

When you use the Tire Mobility Kit, the tire pressure sensors and wheel may be stained by sealant. Therefore, remove the tire pressure sensors and wheel stained by sealant and have your vehicle inspected by an authorized Kia dealer.

Checking the tire inflation pressure

After driving briefly so as to distribute the sealant throughout the inside of the tire, you should check the tire inflation pressure.

1. After driving approximately 4~6 miles (7~10 km or about 10 min), stop at a safe location.
2. Connect the filling hose (3) of the compressor (clip mounted side) directly and then connect the filling hose (3) (opposite side) to the tire valve.



3. Connect between compressor and the vehicle power outlet using the cable and connectors.
4. Adjust the tire inflation pressure to the cold tire recommended pressure as indicated on the vehicle's placard or tire inflation pressure label located on the driver's side center pillar outer panel. (In this owner's manual, refer to "Tires and wheels" on page 8-25)
 - **To increase the inflation pressure**, switch on the compressor, position I. To check the current inflation pressure setting, briefly switch off the compressor.

* NOTICE

The pressure gauge may show higher than actual reading when the compressor is running. To get an accurate tire reading, the compressor needs to be turned off.

⚠ CAUTION

Do not let the compressor run for more than 10 minutes; otherwise, the device may overheat and be damaged.

- **To reduce the inflation pressure**, press the button (9) on the compressor.

⚠ CAUTION

Tire pressure sensor

When you use the Tire Mobility Kit including sealant not approved by Kia, the tire pressure sensors may be damaged by sealant. The sealant on the tire pressure sensor and wheel should be removed when you replace the tire with a new one and inspect the tire pressure sensors at an authorized dealer.

Technical data

The specifications of the Tire Mobility Kit are as follows.

System Voltage		DC 12 V
Working Voltage		DC 10-15 V
Amperage rating		MAX. 10±1 A (at DC 12 V operation)
Suitable for use at temperatures		-22~+158 °F (-30~+70 °C)
Max. working pressure		87 psi (6 bar)
Size	Compressor	6.3 X 5.9 X 2.2 in (161 X 150 X 55.8 mm)
	Sealant bottle	∅ 3.3 X 4.1 in (∅ 85 X 104 mm)
	Compressor weight	1.43±0.07 lbs (650±30 g)
	Sealant volume	18.3 cu in (300 ml)

* Sealant and spare parts can be obtained and replaced at an authorized vehicle or tire dealer. Empty sealant bottles may be disposed of at home. Liquid residue from the sealant should be disposed of by your vehicle or tire dealer or in accordance with local waste disposal regulations.

Towing

If emergency towing is necessary, we recommend having it done by an authorized Kia dealer or a commercial tow-truck service.

Towing service

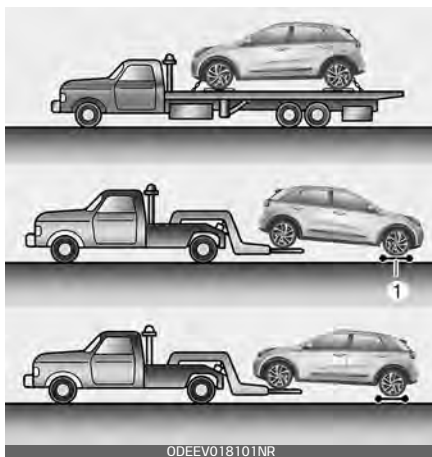

Proper lifting and towing procedures are necessary to prevent damage to the vehicle. The use of wheel dollies (1) or flatbed is recommended.

On FWD vehicles, it is acceptable to tow the vehicle with the rear wheel on the ground (without dollies) and the front wheels off the ground. If any of the loaded wheels or suspension components are damaged or the vehicle is being towed with the front wheels on the ground, use a towing dolly under the front wheels. When being towed by a commercial tow truck and wheel dollies are not

used, the front of the vehicle should always be lifted, not the rear.

⚠ WARNING

Side and curtain Air bag

If your vehicle is equipped with side and curtain air bag, place the POWER button in the OFF or ACC when the vehicle is being towed.

The side and curtain air bag may deploy when the POWER button is ON, and the rollover sensor detects the situation as a rollover.

⚠ CAUTION

Towing



ODEEV018102NR



ODEEV088020NR

- Do not tow the vehicle backwards with the front wheels on the ground as this may cause damage to the vehicle.
- Do not tow with sling-type equipment. Use wheel lift or flatbed equipment.

⚠ WARNING

- If you tow the vehicle while the front wheels are touching the ground, the vehicle motor may generate electricity and the motor components may be damaged or a fire may occur.
- When a vehicle fire occurs due to the battery, there is a risk of a second fire. Contact the fire department when towing the vehicle.

Towing without Wheel Dollies when using a Towing Service

When towing your vehicle in an emergency without wheel dollies:

1. While depressing the brake pedal shift to the N (Neutral) position and turn the vehicle off. The POWER button will be in the ACC position.
2. Place the shifter dial in N (Neutral).
3. Release the parking brake.

⚠ CAUTION

Towing gear position

Failure to shift to N (Neutral) may cause internal damage to the vehicle.

Using removable towing hook (if equipped)

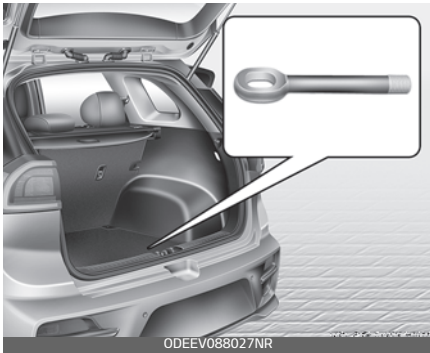

Front

1. Open the liftgate, and remove the towing hook from the tool case.
2. Remove the hole cover pressing the upper (front) / lower (rear) part of the cover on the bumper.
3. Install the towing hook by turning it clockwise into the hole until it is fully secured.
4. Remove the towing hook and install the cover after use.

Emergency towing

If towing service is not available in an emergency, your vehicle may be temporarily towed using a cable or chain secured to the emergency towing hook under the front (or rear) of the vehicle.

Front



Rear



Rear



ODEEV088024NR

If towing is necessary, have it done by an authorized Kia dealer or a commercial tow truck service.

Use extreme caution when towing the vehicle. A driver must be in the vehicle to steer it and operate the brakes.

Towing in this manner may be done only on hard-surfaced roads for a short distance and at low speed. Also, the wheels, axles, power train, steering and brakes must all be in good condition.

- Do not use the tow hooks to pull a vehicle out of mud, sand or other conditions from which the vehicle cannot be driven out under its own power.
- Avoid towing a vehicle heavier than the vehicle doing the towing.
- The drivers of both vehicles should communicate with each other frequently.

⚠ CAUTION

Using a portion of the vehicle other than the tow hooks for towing may damage the body of your vehicle.

- Attach a towing strap to the tow hook.
- Use only a cable or chain specifically intended for use in towing vehicles. Securely fasten the cable or chain to the towing hook provided.
- Before emergency towing, check if the hook is not broken or damaged.
- Fasten the towing cable or chain securely to the hook.
- Do not jerk the hook. Apply it steadily and with even force.
- To avoid damaging the hook, do not pull from the side or at a vertical angle. Always pull straight ahead.
- Use a towing strap less than 16 feet (5 m) long. Attach a white or red cloth (about 12 inches (30 cm) wide) in the middle of the strap for easy visibility.

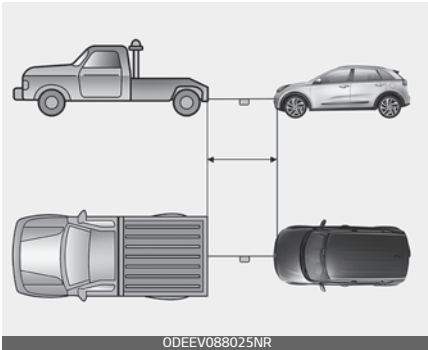

- Drive carefully so that the towing strap is not loosened during towing.

⚠ WARNING

Emergency Towing Precautions

Use extreme caution when towing the vehicle.

- Avoid sudden starts or erratic driving maneuvers which would place excessive stress on the emergency towing hook and towing cable or chain. The hook and towing cable or chain may break and cause serious injury or damage.
- If the disabled vehicle is unable to be moved, do not forcibly continue the towing. We recommend that you contact an authorized Kia dealer or a commercial tow truck service for assistance.
- Tow the vehicle as straight ahead as possible.
- Keep away from the vehicle during towing.

Emergency towing precautions

1. While depressing the brake pedal shift to the N (Neutral) position and turn the vehicle off. The POWER button will be in the ACC position.
2. Release the parking brake.
3. Press the brake pedal with more force than normal since you will have reduced brake performance.
4. More steering effort will be required because the power steering system will be disabled.
5. If you are driving down a long hill, the brakes may overheat and brake performance will be reduced. Stop often and let the brakes cool off.
6. If the car is being towed with all four wheels on the ground, it can be towed only from the front. Be sure that the reduction gear is in neutral. Be sure the steering is unlocked by placing the POWER button in the ACC position. A driver must be in the towed vehicle to operate the steering and brakes.

⚠ CAUTION

To avoid damage to your vehicle and vehicle components when towing:

- Always pull straight ahead when using the towing hooks. Do not pull from the side or at a vertical angle.
- Do not use the towing hooks to pull a vehicle out of mud, sand or other conditions from which the vehicle cannot be driven out under its own power.
- Limit the vehicle speed to 10 mph (15 km/h) and drive less than 1 mile (1.5 km) when towing to avoid serious damage to the reduction gear.

*** NOTICE**

Before towing, check the reduction gear for fluid leaks under your vehicle. If the reduction gear fluid is leaking, a flatbed equipment or towing dolly must be used.

If an accident occurs

If an accident occurs, stay calm and take the following precautions.

⚠ WARNING**High voltage components**

- For your safety, do not touch high voltage cables, connectors and package modules. High voltage components are orange in color.
- Exposed cables or wires may be visible inside or outside of the vehicle. Never touch the wires or cables, because an electrical shock, an injury, or a death may occur.

*** NOTICE**

Any gas or electrolyte leakage from your vehicle is not only poisonous but also flammable. Upon witnessing one of those, make sure your car is parked in a safe area away from any roads, open the windows, and maintain a safe distance away from the vehicle. Immediately contact an authorized Kia dealer and advise them that an electric vehicle is involved.

- If you need towing, refer to "Towing" on page 7-24.
- When the vehicle is severely damaged, remain a safe distance of 50 feet (15 meter) or more between your vehicle and other vehicles/flammables.
- If a fire occurs, immediately call emergency services (911) and advise the emergency responders that an electric vehicle is involved.

 **WARNING**

Submersion in water

Do not touch your vehicle if it has been submerged in water. The high-voltage battery may cause shock or may catch fire. Immediately contact the authorities and advise them of the condition of your vehicle and that an electric vehicle is involved.

Motor room compartment	8-4
Maintenance services	8-5
Owner maintenance	8-7
Scheduled maintenance service	8-9
Explanation of scheduled maintenance items	8-12
Coolant	8-14
• Checking the coolant level.....	8-15
• Changing the coolant.....	8-16
Brake fluid	8-17
• Checking the brake fluid level.....	8-17
Washer fluid	8-18
• Checking the washer fluid level.....	8-18
Climate control air filter	8-19
• Inspecting and replacing climate control air filter.....	8-19
Wiper blades	8-20
• Replacing front windshield wiper blade.....	8-21
• Replacing rear window wiper blade.....	8-22
Battery	8-23
Tires and wheels	8-25
• Checking tire inflation pressure.....	8-26
• Tire rotation.....	8-27
• Wheel alignment and tire balance.....	8-28
• Tire replacement.....	8-28
• Wheel replacement.....	8-29
• Tire traction.....	8-29
• Tire maintenance.....	8-29

8 Maintenance

• Tire sidewall labeling	8-29
• Tire terminology and definitions	8-33
• All season tires	8-36
• Summer tires	8-36
• Snow tires	8-36
• Tire chains.....	8-37
• Radial-ply tires.....	8-37
• Low aspect ratio tire.....	8-38
Fuses	8-39
• Replacing inner panel fuse.....	8-41
• Replacing motor compartment fuse.....	8-42
• Fuse/relay panel description	8-44
Light bulbs.....	8-54
• Replacing headlamp (LED type)	8-57
• Replacing headlamp (high/low beam) bulb	8-58
• Replacing front turn signal lamp bulb.....	8-59
• Replacing fog lamp/DRL/position lamp bulb	8-59
• Replacing stop and tail lamp (rear bulb type) bulb.....	8-60
• Replacing tail lamp (inside) bulb.....	8-61
• Replacing stop and tail lamp (LED type) bulb	8-61
• Replacing back-up lamp bulb.....	8-62
• Replacing high mounted stop lamp bulb	8-62
• Replacing license plate lamp bulb	8-62
• Replacing side repeater lamp (LED type) bulb	8-63
• Replacing map lamp (bulb type) bulb.....	8-63
• Replacing map lamp (LED type) bulb	8-64
• Replacing vanity mirror lamp bulb.....	8-64
• Replacing room lamp (bulb type) bulb	8-65
• Replacing room lamp (LED type) bulb.....	8-65
• Replacing liftgate room lamp bulb.....	8-66

Appearance care	8-67
• Exterior care.....	8-67
• Interior care.....	8-72
California perchlorate notice	8-75

MAINTENANCE

Motor room compartment

Open the hood to see the motor room compartment.

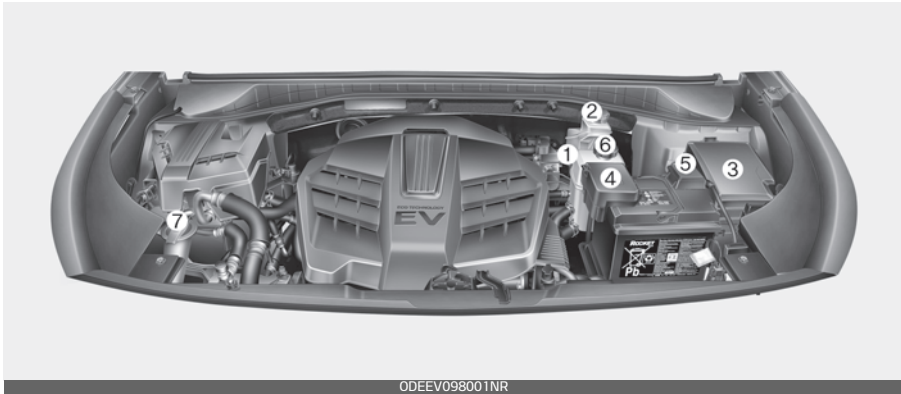

* The actual motor compartment in the vehicle may differ from the illustration.

1. Coolant reservoir
2. Brake fluid reservoir
3. Fuse box
4. Positive battery terminal
5. Negative battery terminal
6. Radiator cap
7. Windshield washer fluid reservoir

Maintenance services

You should exercise the utmost care to prevent damage to your vehicle and injury to yourself whenever performing any maintenance or inspection procedures.

Should you have any doubts concerning the inspection or servicing of your vehicle, we strongly recommend that you have an authorized Kia dealer perform this work.

An authorized Kia dealer has factory-trained technicians and genuine Kia parts to service your vehicle properly. For expert advice and quality service, see an authorized Kia dealer.

Inadequate, incomplete or insufficient servicing may result in operational problems with your vehicle that could lead to vehicle damage, an accident, or personal injury.

Owner's responsibility

* NOTICE

Maintenance Service and Record Retention are the owner's responsibility.

You should retain documents that show proper maintenance has been performed on your vehicle in accordance with the scheduled maintenance service charts shown on the following pages. You need this information to establish your compliance with the servicing and maintenance requirements of your vehicle warranties.

Detailed warranty information is provided in your Warranty & Consumer Information manual.

Repairs and adjustments required as a result of improper maintenance or a lack of required maintenance are not covered.

We recommend you have your vehicle maintained and repaired by an authorized Kia dealer. An authorized Kia dealer meets Kia's high service quality standards and receives technical support from Kia in order to provide you with a high level of service satisfaction.

*** NOTICE****NHTSA Safety Corrosion Alert**

The National Highway Traffic Safety Administration (NHTSA) has issued a general warning to all vehicle owners of all brands regarding the risks associated with vehicle underbody corrosion. From your initial purchase, take the following steps to prevent unsafe corrosion damage to your vehicle:

- Wash the undercarriage of your vehicle regularly during the winter and whenever your vehicle has been exposed to such salts or chemicals.
 - Do a thorough washing of the undercarriage at the end of the winter.
 - Use professional service technicians or governmental inspection stations to annually inspect for corrosion.
 - Immediately seek an inspection of your vehicle if you become visually aware of corrosion flaking or scaling or if you become aware of a change in vehicle performance, such as soft or spongy brakes, fluids leaking, impairment of directional control, suspension noises or rattling metal straps.
 - NHTSA further advises that after a vehicle is 7 years old, it is essential that you take these indicated maintenance steps to ensure that you protect yourself from unsafe corrosion conditions.
-

Owner maintenance precautions



Improper or incomplete service may result in problems. This section gives instructions only for the maintenance items that are easy to perform.

As explained earlier in this section, several procedures can be done only by an authorized Kia dealer with special tools.

*** NOTICE**

Improper owner maintenance during the warranty period may affect warranty coverage. For details, read the separate Warranty & Consumer Information manual provided with the vehicle. If you're unsure about any servicing or maintenance procedure, have it done by an authorized Kia dealer.

⚠ WARNING**Maintenance work**

Do not wear jewelry or loose clothing while working under the hood of your vehicle with ready () mode. These items can become entangled in moving parts, if you must run the vehicle in the ready () mode while working under the hood, make certain that you remove all jewelry (especially rings, bracelets, watches, and necklaces) and all neckties, scarves, and similar loose clothing before getting near cooling fans.

⚠ WARNING**Touching metal parts**

Do not touch metal parts (including strut bars) while the vehicle is operating or hot. Doing so could result in serious bodily injury. Turn the vehicle off and wait until the metal parts cool down to perform maintenance work on the vehicle.

Owner maintenance

The following lists are vehicle checks and inspections that should be performed by the owner or an authorized Kia dealer at the frequencies indicated to help ensure safe, dependable operation of your vehicle.

Any adverse conditions should be brought to the attention of your dealer as soon as possible.

These Owner Maintenance Checks are generally not covered by warranties and you may be charged for labor, parts and lubricants used.

When you stop for charge

- Check the coolant level in coolant reservoir.
- Check the windshield washer fluid level.
- Look for low or under-inflated tires. Check if the front of the radiator and condenser are clean and not blocked with leaves, dirt or insects etc. If any of the above parts are extremely dirty or you are not sure of their condition, take your vehicle to an authorized Kia dealer.

While operating your vehicle:

- Check for vibrations in the steering wheel. Notice any increased steering effort or looseness in the steering wheel, or change in its straight-ahead position.
- Notice if your vehicle constantly turns slightly or "pulls" to one side when traveling on smooth, level road.
- When stopping, listen and check for unusual sounds, pulling to one side, increased brake pedal travel or "hard-to-push" brake pedal.
- If any slipping or changes in the operation of your transmission occurs, check the transmission fluid level.
- Check the reduction gear P (Park) function.
- Check the parking brake.
- Check for fluid leaks under your vehicle (water dripping from the air conditioning system during or after use is normal).

At least monthly:

- Check the coolant level in the coolant reservoir.
- Check the operation of all exterior lights, including the stoplights, turn signals and hazard warning flashers.
- Check the inflation pressures of all tires including the spare for tires that are worn, show uneven wear, or are damaged.
- Check for loose wheel lug nuts.

At least twice a year (i.e., every Spring and Fall):

- Check the radiator, heater and air conditioning hoses for leaks or damage.
- Check the windshield washer spray and wiper operation. Clean the wiper blades with clean cloth dampened with washer fluid.
- Check the headlight alignment.
- Check the lap/shoulder belts for wear and function.

At least once a year:

- Clean the body and door drain holes.
- Lubricate the door hinges and check the hood hinges.
- Lubricate the door and hood locks and latches.
- Lubricate the door rubber weatherstrips.
- Check the air conditioning system.
- Inspect and lubricate automatic transmission linkage and controls.
- Clean the battery and terminals.
- Check the brake fluid level.

Scheduled maintenance service

Follow the Normal Maintenance Schedule if the vehicle is usually operated where none of the following conditions apply.

If any of the following conditions apply, follow the Maintenance Under Severe Usage Conditions.

- Repeated driving short distance of less than 5 miles (8 km) in normal temperature or less than 10 miles (16 km) in freezing temperature.
- Extensive motor idling or low speed driving for long distances.
- Driving on rough, dusty, muddy, unpaved, graveled or salt-spread roads.
- Driving in areas using salt or other corrosive materials or in very cold weather.
- Driving in heavy dust condition.
- Driving in heavy traffic area.
- Driving on uphill, downhill, or mountain road repeatedly.
- Towing a trailer or using a camper, or roof rack.
- Driving as a patrol car, taxi, other commercial use of vehicle towing.
- Driving over 106 mph (170 km/h).
- Frequently driving in stop-and-go condition.

If your vehicle is operated in any of the prior listed conditions, you should inspect, replace or refill more frequently, using the severe usage maintenance schedule instead of the normal usage maintenance schedule.

Normal maintenance schedule - Non Turbo Models

The following maintenance services must be performed to ensure good emission control and performance. Keep receipts for all vehicle emission services to protect your warranty. Where both mileage and time are shown, the frequency of service is determined by whichever occurs first.

R: Replace

I: Inspect and if necessary, adjust, correct, clean or replace

Number of months or driving distance, whichever comes first																
Months	12	24	36	48	60	72	84	96	108	120	132	144	156	168	180	
Miles×1,000	7.5	15	22.5	30	37.5	45	52.5	60	67.5	75	82.5	90	97.5	105	112.5	
Km×1,000	12	24	36	48	60	72	84	96	108	120	132	144	156	168	180	
Coolant*1	Replace at first, 120,000 miles (192,000 km) after that, every 30,000 miles (48,000 km)															
Reduction gear oil	-	-	I	-	I	-	I	-	I	-	I	-	I	-	I	
Drive shafts and boots	I	I	I	I	I	I	I	I	I	I	I	I	I	I	I	
Cooling system	-	-	-	I	-	I	-	I	-	I	-	I	-	I	-	
Air conditioner refrigerant / compressor (if equipped)	I	I	I	I	I	I	I	I	I	I	I	I	I	I	I	
Climate control air filter (if equipped)	I	R	I	R	I	R	I	R	I	R	I	R	I	R	I	
Disc brakes and pads	I	I	I	I	I	I	I	I	I	I	I	I	I	I	I	
Brake lines, hoses and connections	I	I	I	I	I	I	I	I	I	I	I	I	I	I	I	
Brake pedal	I	I	I	I	I	I	I	I	I	I	I	I	I	I	I	
Brake fluid	I	I	I	I	I	I	I	I	I	I	I	I	I	I	I	
Steering gear rack, linkage and boots	I	I	I	I	I	I	I	I	I	I	I	I	I	I	I	
Suspension ball joints	I	I	I	I	I	I	I	I	I	I	I	I	I	I	I	
Tire (pressure & tread wear)	I	I	I	I	I	I	I	I	I	I	I	I	I	I	I	
12 V Battery condition	I	I	I	I	I	I	I	I	I	I	I	I	I	I	I	

*1. When adding coolant, use only deionized water or soft water for your vehicle and never mix hard water in the coolant filled at the factory. An improper coolant mixture can result in serious malfunction or motor compartment damage.

Maintenance Under Severe Usage Conditions

The following items must be serviced more frequently on cars mainly used under severe driving conditions. Refer to the chart below for the appropriate maintenance intervals.

R: Replace

I: Inspect and if necessary, adjust, correct, clean or replace

Maintenance item	Maintenance operation	Maintenance intervals	Driving condition
Reduction gear oil	R	Every 80,000 miles (120,000 km)	C, D, E, G, H, I, K
Drive shaft and boots	I	Inspect more frequently depending on the condition	C, D, E, F, G, H, I, K
Climate control air filter (if equipped)	I	Inspect more frequently depending on the condition	C, D, E, F, G
Disc brakes and pads	I	Inspect more frequently depending on the condition	C, D, E, G, H
Steering gear rack, linkage and boots	I	Inspect more frequently depending on the condition	C, D, E, F, G, H, I, K
Front suspension ball joints	R	Replace more frequently depending on the condition	C, E, G

Severe Driving Conditions

A: Repeatedly driving short distance of less than 5 miles (8 km) in normal temperature or less than 10 miles (16 km) in freezing temperature.

B: Extensive low speed driving for long distances.

C: Driving on rough, dusty, muddy, unpaved, graveled or salt-spread roads.

D: Driving in areas using salt or other corrosive materials or in very cold weather.

E: Driving in heavy dust condition.

F: Driving in heavy traffic area.

G: Driving on uphill, downhill, or mountain roads.

H: Towing a trailer or using a camper on roof rack.

I: Driving for patrol car, taxi, commercial car or vehicle towing.

J: Driving in very cold weather.

K: Driving over 106 mph (170 km/h).

L: Frequently driving in stop-and-go conditions.

Explanation of scheduled maintenance items

The following parts require scheduled maintenance.

Cooling system

Check the cooling system components, such as the radiator, coolant reservoir, hoses and connections, coolant 3-way valve, chiller for leakage and damage. Replace any damaged parts.

Coolant

The coolant should be changed at the intervals specified in the maintenance schedule.

Brake hoses and lines

Visually check for proper installation, chafing, cracks, deterioration and any leakage. Replace any deteriorated or damaged parts immediately.

* NOTICE

NHTSA Safety Corrosion Alert

NHTSA has warned all vehicle owners of all brands that they must maintain their vehicles in a manner which will prevent brake hose and brake line failures due to corrosion when such vehicles are exposed to winter road salt and related chemicals. While serious corrosion conditions typically only manifest themselves as safety issues after 7 years of vehicle use, the corrosion process starts immediately and thus underbody cleaning maintenance must commence from your vehicle's first exposure to road salts and chemicals. NHTSA urges vehicle owners to take the following steps to prevent corrosion:

1. Wash the undercarriage of your vehicle regularly throughout the winter and do a thorough washing in the spring to remove road salt and other de-icing chemicals.
 2. Monitor the brake system for signs of corrosion by having regular professional inspections and watching for signs of problems, including loss of brake fluid, unusual leaks and soft or spongy feel in the brake pedal.
 3. Replace the entire brake pipe assembly if you find severe corrosion that causes scaling or flaking of brake components.
-

Brake fluid

Check the brake fluid level in the brake fluid reservoir. The level should be between "MIN" and "MAX" marks on the side of the reservoir. Use only hydraulic brake fluid conforming to DOT 3 or DOT 4 specification.

Brake discs, pads, calipers and rotors

Check the pads for excessive wear, discs for run out and wear, and calipers for fluid leakage.

Suspension mounting bolts

Check the suspension connections for looseness or damage. Retighten to the specified torque.

Steering gear box, linkage & boots/ lower arm ball joint

With the vehicle stopped and off, check for excessive free-play in the steering wheel.

Check the linkage for bends or damage. Check the dust boots and ball joints for deterioration, cracks, or damage. Replace any damaged parts.

Drive shafts and boots

Check the drive shafts, boots and clamps for cracks, deterioration, or damage. Replace any damaged parts and, if necessary, repack the grease.

Air conditioning refrigerant

Check the air conditioning lines and connections for leakage and damage.

Coolant

The high-pressure cooling system has a reservoir filled with year round antifreeze coolant. The reservoir is filled at the factory.

Check the antifreeze protection and coolant level at least once a year, at the beginning of the winter season, and before traveling to a colder climate.

⚠ CAUTION

Radiator/Inverter cap

Never attempt to remove the radiator or inverter cap while the motor is operating or hot. Doing so might lead to cooling system and motor damage.

Recommended coolant

When adding coolant, use only deionized water or soft water for your vehicle and never mix hard water in the coolant filled at the factory. An improper coolant mixture can result in serious malfunction or damage.

- Do not use alcohol or methanol coolant or mix them with the specified coolant.
- Do not use a solution that contains more than 60% antifreeze or less than 35% antifreeze, which would reduce the effectiveness of the solution.

- The cooling circuit of a vehicle equipped with a heat pump system may freeze in extremely low temperature when the concentration of the antifreezing liquid is below 45%.

For mixture percentage, refer to the following table.

Ambient Temperature	Mixture Percentage (volume)	
	Antifreeze	Water
5 °F (-15 °C)	35	65
-13 °F (-25 °C)	40	60
-31 °F (-35 °C)	50	50
-49 °F (-45 °C)	60	40

⚠ WARNING

 Radiator cap



ODEEV098002NR

Do not remove the radiator cap when the motor compartment and radiator are hot. Scalding hot coolant and steam may blow out under pressure which may result in serious injury.

* NOTICE

Make sure the coolant cap is properly closed after refill or coolant. Otherwise the motor compartment could be overheated while driving.

1. Check if the radiator cap label is straight In front.

Motor compartment room front view



ODEEV098003NR

2. Make sure that the tiny protrusions inside the coolant cap are securely interlocked.

Motor compartment room rear view



ODEEV098004NR

Checking the coolant level

⚠ WARNING

 Removing radiator cap
 Never attempt to remove the radiator cap while the motor compartment is operating or hot. Doing so might lead to cooling system damage and could result in serious personal injury from escaping hot coolant or steam.

1. Turn the vehicle off and wait until it cools down.
2. Use extreme care when removing the radiator cap. Wrap a thick towel around it, and turn it counterclockwise slowly to the first stop.



ODEEV098002NR

3. Step back while the pressure is released from the cooling system.
4. When you are sure all the pressure has been released, press down on the cap, using a thick towel, and continue turning counterclockwise to remove it.

WARNING

Cooling fan



Use caution when working near the blade of the cooling fan. The electric motor (cooling fan) is controlled by coolant temperature, refrigerant pressure and vehicle speed. It may sometimes operate even when the vehicle is not running.

5. Check the condition and connections of all cooling system hoses and heater hoses.
6. Replace any swollen or deteriorated hoses.

7. Check the coolant level. The coolant level should be filled between F and L marks on the side of the coolant reservoir when the motor room is cool.
8. If the coolant level is low, add enough specified coolant to provide protection against freezing and corrosion. Bring the level to F, but do not overfill.

If frequent additions are required, see an authorized Kia dealer for a cooling system inspection.

Changing the coolant

Have the coolant changed by an authorized Kia dealer according to the Maintenance Schedule at the beginning of this chapter.

CAUTION

Put a thick cloth or fabric around the radiator cap before refilling the coolant in order to prevent the coolant from overflowing into motor compartment parts such as the alternator.

Brake fluid

The brake fluid acts to transmit force to the brake when the driver depresses the brake pedal. Brake fluid must be maintained periodically to ensure that the brakes operate smoothly.

Checking the brake fluid level

Check the fluid level in the reservoir periodically. The fluid level should be between MAX and MIN marks on the side of the reservoir.



0DEEV098006NR

1. Before removing the reservoir cap and adding brake fluid, clean the area around the reservoir cap thoroughly to prevent brake fluid contamination.

CAUTION

Proper fluid

Only use brake fluid in the brake system. Small amounts of improper fluids can cause damage to the brake system.

2. If the level is low, add fluid to the MAX level. The level will fall with accumulated mileage. This is a normal condition associated with the wear of the brake linings. If the fluid level is excessively low, have the brake system checked by an authorized Kia dealer.

Use only the specified brake fluid. (Refer to "Recommended lubricants and capacities" on page 9-5.)

Never mix different types of fluid.

In the event the brake system requires frequent additions of fluid, the vehicle should be inspected by an authorized Kia dealer.

When changing and adding brake fluid, handle it carefully. Do not let it come in contact with your eyes. If brake fluid should come in contact with your eyes, immediately flush them with a large quantity of fresh tap water. Have your eyes examined by a doctor as soon as possible.

CAUTION

Brake fluid

Do not allow brake fluid to contact the vehicle's body paint, as paint damage will result.

Brake fluid, which has been exposed to open air for an extended time should never be used as its quality cannot be guaranteed. It should be disposed of properly.

Washer fluid

Washer fluid is used when wiping the windshield of the vehicle with a windshield wiper. You should check and refill washer fluid periodically to make sure that it doesn't run out.

Checking the washer fluid level



ODEEV098007NR

The reservoir is translucent so that you can check the level with a quick visual inspection.

- Check the fluid level in the washer fluid reservoir and add fluid if necessary. Plain water may be used if washer fluid is not available. However, use washer solvent with antifreeze characteristics in cold climates to prevent freezing.

⚠ WARNING

Flammable Fluid

Do not allow the washer fluid to come in contact with open flames or sparks. The windshield washer fluid reservoir is flammable under certain circumstances. This can result in a fire.

⚠ WARNING

Coolant

- Do not use radiator coolant or antifreeze in the washer fluid reservoir.
- Radiator coolant can severely obscure visibility when sprayed on the windshield and may cause loss of vehicle control.

⚠ WARNING

Windshield fluid

Do not drink the windshield washer fluid. The windshield washer fluid is poisonous to humans and animals.

Climate control air filter

The climate control air filter should be replaced according to the maintenance schedule. If the vehicle is operated in severely air-polluted cities or on dusty rough roads for a long period, it should be inspected more frequently and replaced earlier.

Inspecting and replacing climate control air filter

When you replace the climate control air filter, replace it performing the following procedure, and be careful to avoid damaging other components.

1. Open the glove box.



2. With the glove box open, pull the support strap (1).



3. Remove the climate control air filter case by pulling out both sides of the cover.

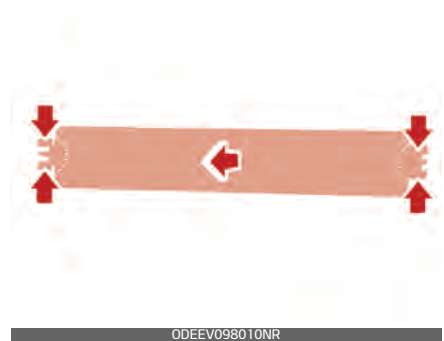

4. Replace the climate control air filter.

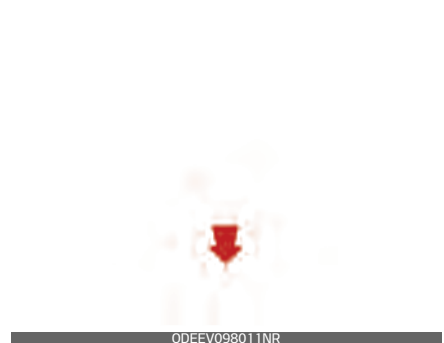

5. Reassemble in the reverse order of disassembly.

When replacing the climate control air filter install it properly. Otherwise, the system may produce noise and the effectiveness of the filter may be reduced.

Wiper blades

When the wipers no longer clean adequately, the blades may be worn or cracked, and require replacement.

To prevent damage to the wiper arms or other components, do not attempt to move the wipers manually.

The use of a non-specified wiper blade could result in wiper malfunction and failure.

Blade inspection



Commercial hot waxes applied by automatic vehicle washes have been known to make the windshield difficult to clean.

Contamination of either the windshield or the wiper blades with foreign matter can reduce the effectiveness of the windshield wipers. Common sources of contamination are insects, tree sap, and hot wax treatments used by some commercial vehicle washes. If the blades are not wiping properly, clean both the window and the blades with a good cleaner or mild detergent, and rinse thoroughly with clean water.

⚠ CAUTION

Wiper blades

To prevent damage to the wiper blades, do not use gasoline, kerosene, paint thinner, or other solvents on or near them.

Replacing front windshield wiper blade

Type A

1. Raise the wiper arm and turn the wiper blade assembly to expose the plastic locking clip.



ODEEV098013NR

⚠ CAUTION

Wiper arms

- Do not allow the wiper arm to fall against the windshield, since it may chip or crack the windshield.
- Do not pull wiper arm forward, since arm could chip hood paint.

2. Compress the clip and slide the blade assembly downward.



ODEEV098014NR

3. Lift it off the arm.

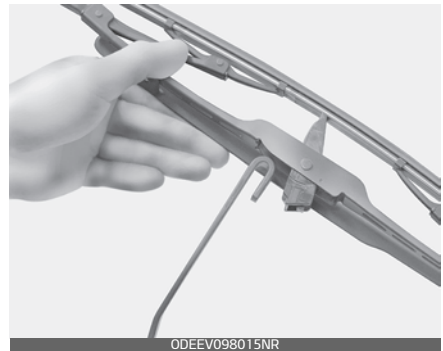

ODEEV098015NR

4. Install the blade assembly in the reverse order of removal.

Type B

1. Raise the wiper arm.
2. Lift up the wiper blade clip. Then pull down the blade assembly and remove it.



ODEEV098016NR

3. Install the new blade assembly.



ODEEV098017NR

4. Return the wiper arm on the windshield.
5. Change POWER button to the ON position and wiper arms will return to the normal operating position.

Replacing rear window wiper blade

1. Raise the wiper arm and pull out the wiper blade assembly.



ODEEV098018NR

2. Install the new blade assembly by inserting the center part into the slot in the wiper arm until it clicks into place.



ODEEV098019NR

3. Make sure the blade assembly is installed firmly by trying to pull it slightly.

To prevent damage to the wiper arms or other components, have an authorized Kia dealer replace the wiper blade.

Battery

The battery powers the motor in order to move the vehicle as well as supplying power to the various devices installed in the vehicle.

For best battery service



ODEEV098020NR

- Keep the battery securely mounted.
- Keep the battery top clean and dry.
- Keep the terminals and connections clean, tight, and coated with petroleum jelly or terminal grease.
- Rinse any spilled electrolyte from the battery immediately with a solution of water and baking soda.
- If the vehicle is not going to be used for an extended time, disconnect the battery cables.

⚠ WARNING

Risk of explosion



Keep lit cigarettes and all other flames or sparks away from the battery.



The battery contains hydrogen -- a highly combustible gas which will explode if it comes in contact with a flame or spark.



Keep batteries out of the reach of children because batteries contain highly corrosive SULFURIC ACID and electrolytes. Do not allow battery acid to contact your skin, eyes, clothing or paint finish.



Wear eye protection when charging or working near a battery. Always provide ventilation when working in an enclosed space.



Always read the following instructions carefully when handling a battery.



If any electrolyte gets into your eyes, flush your eyes with clean water for at least 15 minutes and get immediate medical attention. If electrolyte gets on your skin, thoroughly wash the contacted area. If you feel pain or burning sensation, get medical attention immediately.



An inappropriately disposed battery can be harmful to the environment and human health. Dispose the battery according to your local law(s) or regulation.



The battery contains lead. Do not dispose of it after use. Please return the battery to an authorized Kia dealer to be recycled.

Never attempt to recharge the battery when the battery cables are connected.

⚠ WARNING

Risk of electrocution

Never touch the electrical motor while the vehicle is running. This system works with high voltage which can "zap" you.

*** NOTICE**

If you connect unauthorized electronic devices to the battery, the battery may be discharged. Never use unauthorized devices.

⚠ WARNING

Recharging battery

Never attempt to recharge the battery when the battery cables are connected.

⚠ WARNING

Battery lead compound

Battery posts, terminals, and related accessories contain lead and lead compounds. Wash hands after handling.

Battery recharging

Your vehicle has a maintenance-free, calcium-based battery

- If the battery becomes discharged in a short time (because, for example, the headlights or interior lights were left on while the vehicle was not in use), recharge it by slow charging (trickle) for 10 hours.
- If the battery gradually discharges because of high electric load while the vehicle is being used, recharge it at 20~30 A for two hours.

When recharging the battery, observe the following precautions:

- The battery must be removed from the vehicle and placed in an area with good ventilation.
- Do not allow cigarettes, sparks, or flame near the battery.
- Watch the battery during charging, and stop or reduce the charging rate if the battery cells begin gassing (boiling) violently or if the temperature of the electro-

lyte of any cell exceeds 120 °F (49 °C).

- Wear eye protection when checking the battery during charging.
- Disconnect the battery charger in the following order.
 1. Turn off the battery charger main switch.
 2. Unhook the negative clamp from the negative battery terminal.
 3. Unhook the positive clamp from the positive battery terminal.
- Before performing maintenance or recharging the battery, turn off all accessories and stop the vehicle.
- The negative battery cable must be removed first and installed last when the battery is disconnected.

Reset items

The following items should be reset after the battery has been discharged or the battery has been disconnected.

- Auto up/down window (Refer to "Window opening and closing" on page 5-21)
- Trip computer (Refer to "Trip information (Trip computer)" on page 5-62)
- Climate control system (Refer to "Automatic climate control system" on page 5-106)

Tires and wheels

For proper maintenance, safety, and maximum fuel economy, you must always maintain recommended tire inflation pressures and stay within the load limits and weight distribution recommended for your vehicle.

Recommended cold tire inflation pressures

All tire pressures should be checked when the tires are cold. "Cold Tires" means the vehicle has not been driven for at least three hours or driven less than one mile (1.6 km).

Recommended pressures must be maintained for the best ride, vehicle handling, and minimum tire wear.

For recommended inflation pressure, refer to "Tires and wheels" on page 8-25.

All specifications (sizes and pressures) can be found on a label attached to the driver's side center pillar.



⚠ WARNING**Tire underinflation**

Inflate your tires consistent with the instructions provided in this manual. Severe underinflation (10 psi (70 kPa) or more) can lead to severe heat build-up, causing blow-outs, tread separation and other tire failures that can result in the loss of vehicle control. This risk is much higher on hot days and when driving for long periods at high speeds.

Failure to maintain specified pressure may result in excessive wear, poor handling, reduced fuel economy, deformation of tire and/or wheel, harsh ride conditions, possibility for additional damage from road hazards, or result in tire failure.

Tire pressure

Always observe the following:

- Check tire pressure when the tires are cold. (After vehicle has been parked for at least three hours or hasn't been driven more than one mile (1.6 km) since startup.)
- Check the pressure of your spare tire each time you check the pressure of other tires.
- Never overload your vehicle. Be careful not to overload a vehicle luggage rack if your vehicle is equipped with one.

- Warm tires normally exceed recommended cold tire pressures by 4 to 6 psi (28 to 41 kPa). Do not release air from warm tires to adjust the pressure or the tires will be underinflated.

⚠ WARNING**Tire Inflation**

Overinflation or underinflation can reduce tire life, adversely affect vehicle handling, and lead to sudden tire failure. This could result in loss of vehicle control and potential injury.

Checking tire inflation pressure

Check your tires once a month or more.

Use a good quality gauge to check tire pressure. You cannot tell if your tires are properly inflated simply by looking at them. Radial tires may look properly inflated even when they're underinflated.

Check the tire's inflation pressure when the tires are cold. "Cold" means your vehicle has been sitting or at least three hours or driven no more than 1 mile (1.6 km).

1. Remove the valve cap from the tire valve stem.
2. Press the tire gauge firmly onto the valve to get a pressure measurement. If the cold tire inflation

pressure matches the recommended pressure on the tire and loading information label, no further adjustment is necessary.

3. If the pressure is low, add air until you reach the recommended amount.
4. If you overfill the tire, release air by pushing on the metal stem in the center of the tire valve.
5. Recheck the tire pressure with the tire gauge.
6. Be sure to put the valve caps back on the valve stems. They help prevent leaks by keeping out dirt and moisture.

Inspect your tires frequently for proper inflation as well as wear and damage. Always use a tire pressure gauge.

Tires with too much or too little pressure wear unevenly causing poor handling, loss of vehicle control, and sudden tire failure leading to accidents, injuries, and even death. The recommended cold tire pressure for your vehicle can be found in this manual and on the tire label located on the driver's side center pillar.

Tire rotation

To equalize tread wear, it is recommended that the tires be rotated every 6,500 miles (10,000 km) or sooner if irregular wear develops.

During rotation, check the tires for correct balance.

When rotating tires, check for uneven wear and damage. Abnormal wear is usually caused by incorrect tire pressure, improper wheel alignment, out-of-balance wheels, severe braking or severe cornering. Look for bumps or bulges in the tread or side of tire. Replace the tire if you find either of these conditions.

Replace the tire if fabric or cord is visible. After rotation, be sure to bring the front and rear tire pressures to specification and check lug nut tightness.

Refer to "Tires and wheels" on page 8-25.

Disc brake pads should be inspected for wear whenever tires are rotated.

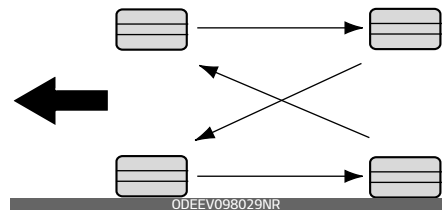

Rotate radial tires that have an asymmetric tread pattern only from front to rear and not from right to left.

⚠ WARNING

Mixing tires

Do not mix bias ply and radial ply tires under any circumstances. This may cause unusual handling characteristics.

Wheel alignment and tire balance

The wheels on your vehicle were aligned and balanced carefully at the factory to give you the longest tire life and best overall performance.

In most cases, you will not need to have your wheels aligned again. However, if you notice unusual tire wear or your vehicle pulling one way or the other, the alignment may need to be reset.

If you notice your vehicle vibrating when driving on a smooth road, your wheels may need to be rebalanced.

⚠ CAUTION

Wheel weight

Improper wheel weights can damage your vehicle's aluminum wheels. Use only approved wheel weights.

Tire replacement

If the tire is worn evenly, a tread wear indicator will appear as a solid band across the tread.



This shows there is less than 1/16 inch (1.6 mm) of tread left on the tire. Replace the tire when this happens.

Do not wait for the band to appear across the entire tread before replacing the tire.

The ABS (Anti-lock Brake System) works by comparing the speed of the wheels. The tire size affects wheel speed. When replacing tires, all 4 tires must use the same size originally supplied with the vehicle. Using tires of a different size can cause the ABS (Anti-lock Brake System) and ESC (Electronic Stability Control) to work irregularly.

It is best to replace all four tires at the same time. If that is not possible, or necessary, then replace the two front or two rear tires as a pair.

Replacing just one tire can seriously affect your vehicle's handling.

* NOTICE

We recommend that when replacing tires, use the same originally supplied with the vehicles. If not, that affects driving performance.

Wheel replacement

When replacing the metal wheels for any reason, make sure the new wheels are equivalent to the original factory units in diameter, rim width and offset.

A wheel that is not the correct size may adversely affect wheel and bearing life, braking and stopping abilities, handling characteristics, ground clearance, body-to-tire clearance, snow chain clearance, speedometer and odometer calibration, headlight aim and bumper height.

⚠ CAUTION

Wheels

Wheels that do not meet Kia specifications may fit poorly and result in damage to the vehicle or unusual handling and poor vehicle control.

Tire traction

Tire traction can be reduced if you drive on worn tires, tires that are improperly inflated or on slippery road surfaces.

Tires should be replaced when tread wear indicators appear. Slow down whenever there is rain, snow or ice on the road to reduce the possibility of losing control of the vehicle.

Tire maintenance

In addition to proper inflation, correct wheel alignment helps to decrease tire wear.

If you find a tire is worn unevenly, have your dealer check the wheel alignment.

When you have new tires installed, make sure they are balanced. This will increase vehicle ride comfort and tire life. Additionally, a tire should always be rebalanced if it is removed from the wheel.

Tire sidewall labeling

This information identifies and describes the fundamental characteristics of the tire and also provides the tire identification number (TIN) for safety standard certification.

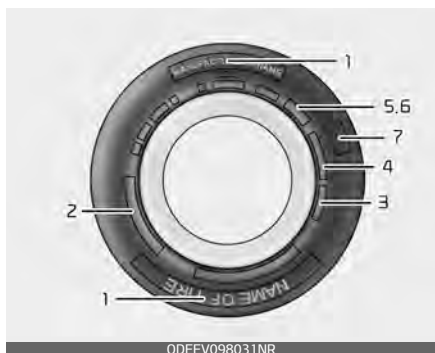

The TIN can be used to identify the tire in case of a recall.

1. *Manufacturer or brand name*

Manufacturer or Brand name is shown.

2. *Tire size designation*

A tire's sidewall is marked with a tire size designation. You will need this information when selecting replacement tires for your vehicle. The following explains what the letters and numbers in the tire size designation mean.

Example tire size designation:

(These numbers are provided as an example only; your tire size designator could vary depending on your vehicle.)

P235/65R17 108T

- P: Applicable vehicle type (tires marked with the prefix "P" are intended for use on passenger vehicles or light trucks; however, not all tires have this marking).
- 235: Tire width in millimeters.
- 65: Aspect ratio. The tire's section height as a percentage of its width.
- R: Tire construction code (Radial).
- 17: Rim diameter in inches.
- 108: Load Index, a numerical code associated with the maximum load the tire can carry.
- T: Speed Rating Symbol. See the speed rating chart in this section for additional information.

Wheel size designation

Wheels are also marked with important information that you need if you ever have to replace one. The following explains what the letters and numbers in the wheel size designation mean.

Example wheel size designation:

7.0JX17

- 7.0: Rim width in inches.
- J: Rim contour designation.
- 17: Rim diameter in inches.

Tire speed ratings

The chart below lists many of the different speed ratings currently being used for passenger vehicle tires. The speed rating is part of the tire size designation on the sidewall of the tire. This symbol corresponds to that tire's designed maximum safe operating speed.

Speed Rating Symbol	Maximum Speed
S	112 mph (180 km/h)
T	118 mph (190 km/h)
H	130 mph (210 km/h)
V	149 mph (240 km/h)
Z	Above 149 mph (240 km/h)

3. Checking tire life (TIN: Tire Identification Number)

Any tires that are over 6 years old, based on the manufacturing date, should be replaced by new ones. You can find the manufacturing date on the tire sidewall (possibly on the inside of the wheel), displaying the DOT Code. The DOT Code is a series of numbers on a tire consisting of numbers and English letters. The manufacturing date is designated by the last four digits (characters) of the DOT code.

DOT: XXXX XXXX 0000

The front part of the DOT means a plant code number, tire size and tread pattern and the last four numbers indicate week and year manufactured.

For example:

DOT XXXX XXXX 1618 represents that the tire was produced in the 16th week of 2018.

WARNING

Tire age

Replace tires within the recommended time frame. Failure to replace tires as recommended can result in sudden tire failure, which could lead to a loss of control and an accident.

4. Tire ply composition and material

The number of layers or plies of rubber-coated fabric in the tire. Tire manufacturers also must indicate the materials in the tire, which include steel, nylon, polyester, and others. The letter "R" means radial ply construction; the letter "D" means diagonal or bias ply construction; and the letter "B" means belted-bias ply construction.

5. Maximum permissible inflation pressure

This number is the greatest amount of air pressure that should be put in the tire. Do not exceed the maximum permissible inflation pressure. Refer to the Tire and Loading Information label for recommended inflation pressure.

6. Maximum load rating

This number indicates the maximum load in kilograms and pounds that can be carried by the tire. When replacing the tires on the vehicle, always use a tire that has the same load rating as the factory installed tire.

7. Uniform tire quality grading

Quality grades can be found where applicable on the tire sidewall between tread shoulder and maximum section width.

For example:

- TREADWEAR 200
- TRACTION AA
- TEMPERATURE A

Tires degrade over time, even when they are not being used. Regardless of the remaining tread, we recommend that tires be replaced after approximately six (6) years of normal service. Heat caused by hot climate or frequent high loading conditions can accelerate the aging process.

Tread wear

The tread wear grade is a comparative rating based on the wear rate of the tire when tested under controlled conditions on a specified government test course. For example, a tire graded 150 would wear one-and-a-half times (1½) as well on the government course as a tire graded 100.

The relative performance of tires depends upon the actual conditions of their use, however, and may depart significantly from the norm due to variations in driving habits, service practices and differences in road characteristics and climate.

These grades are molded on the side-walls of passenger vehicle tires. The tires available as standard or optional equipment on your vehicle may vary with respect to grade.

Traction – AA, A, B & C

The traction grades, from highest to lowest, are AA, A, B and C. Those grades represent the tire's ability to stop on wet pavement as measured under controlled conditions on specified government test surfaces of asphalt and concrete. A tire marked C may have poor traction performance.

The traction grade assigned to this tire is based on straight-ahead braking traction tests, and does not include acceleration, cornering, hydroplaning, or peak traction characteristics.

Temperature -A, B & C

The temperature grades are A (the highest), B and C representing the tire's resistance to the generation of heat and its ability to dissipate heat when tested under controlled conditions on a specified indoor laboratory test wheel.

Sustained high temperature can cause the material of the tire to degenerate and reduce tire life, and excessive temperature can lead to sudden tire failure. The grade C corresponds to a level of performance which all passenger vehicle tires must meet under the Federal Motor Vehicle Safety Standard No. 109. Grades B and A represent higher levels of performance on the laboratory test wheel than the minimum required by law.

Tire terminology and definitions

Refer to the following for detailed definitions of the terms that are found in the tire description.

Air Pressure The amount of air inside the tire pressing outward on the tire. Air pressure is expressed in pounds per square inch (psi) or kilopascal (kPa).

Accessory Weight This means the combined weight of optional accessories. Some examples of optional accessories are automatic transaxle, power seats, and air conditioning.

Aspect Ratio The relationship of a tire's height to its width.

Belt A rubber coated layer of cords that is located between the plies and the tread. Cords may be made from steel or other reinforcing materials.

Bead The tire bead contains steel wires wrapped by steel cords that hold the tire onto the rim.

Bias Ply Tire A pneumatic tire in which the plies are laid at alternate angles less than 90 degrees to the centerline of the tread.

Cold Tire Pressure The amount of air pressure in a tire, measured in pounds per square inch (psi) or kilopascals (kPa) before a tire has built up heat from driving.

Curb Weight This means the weight of a motor vehicle with standard and optional equipment including the maximum capacity of fuel, oil and coolant, but without passengers and cargo.

DOT Markings A code molded into the sidewall of a tire signifying that the tire is in compliance with the U.S. Department of Transportation motor vehicle safety standards. The DOT code includes the Tire Identification Number (TIN), an alphanumeric designator which can also identify the tire manufacturer, production plant, brand and date of production.

GVWR Gross Vehicle Weight Rating

GAWR FRT Gross Axle Weight Rating for the Front Axle.

GAWR RR Gross Axle Weight Rating for the Rear axle.

Intended Outboard Sidewall The side of an asymmetrical tire that must always face outward when mounted on a vehicle.

Kilopascal (kPa) The metric unit for air pressure.

Light truck (LT) tire A tire designated by its manufacturer as primarily intended for use on lightweight trucks or multipurpose passenger vehicles.

Load ratings The maximum load that a tire is rated to carry for a given inflation pressure.

Load Index An assigned number ranging from 1 to 279 that corresponds to the load carrying capacity of a tire.

Maximum Inflation Pressure The maximum air pressure to which a cold tire may be inflated. The maximum air pressure is molded onto the sidewall.

Maximum Load Rating The load rating for a tire at the maximum permissible inflation pressure for that tire.

Maximum Loaded Vehicle Weight

The sum of curb weight; accessory weight; vehicle capacity weight; and production options weight.

Normal Occupant Weight The number of occupants a vehicle is designed to seat multiplied by 150 pounds (68 kg).

Occupant Distribution Designated seating positions.

Outward Facing Sidewall The side of a asymmetrical tire that has a particular side that faces outward when mounted on a vehicle. The outward facing sidewall bears white lettering or bears manufacturer, brand, and/or model name molding that is higher or deeper than the same moldings on the inner facing sidewall.

Passenger (P-Metric) Tire A tire used on passenger cars and some light duty trucks and multipurpose vehicles.

Ply A layer of rubber-coated parallel cords.

Pneumatic tire A mechanical device made of rubber, chemicals, fabric and steel or other materials, that, when mounted on an automotive wheel, provides the traction and contains the gas or fluid that sustains the load.

Production options weight The combined weight of installed regular production options weighing over 5 lb. (2.3 kg) in excess of the standard items which they replace, not previously considered in curb weight or accessory weight, including heavy duty brakes, ride levelers, roof rack, heavy duty battery, and special trim.

Recommended Inflation Pressure Vehicle manufacturer's recommended tire inflation pressure and shown on the tire placard.

Radial Ply Tire A pneumatic tire in which the ply cords that extend to the beads are laid at 90 degrees to the centerline of the tread.

Rim A metal support for a tire and upon which the tire beads are seated.

Sidewall The portion of a tire between the tread and the bead.

Speed Rating An alphanumeric code assigned to a tire indicating the maximum speed at which a tire can operate.

Traction The friction between the tire and the road surface. The amount of grip provided.

Tread The portion of a tire that comes into contact with the road.

Treadwear Indicators Narrow bands, sometimes called "wear bars," that show across the tread of a tire when only 2/32 inch (1.6 mm) of tread remains.

UTQGS Uniform Tire Quality Grading Standards, a tire information system that provides consumers with ratings for a tire's traction, temperature and treadwear. Ratings are determined by tire manufacturers using government testing procedures. The ratings are molded into the sidewall of the tire.

Vehicle Capacity Weight The number of designated seating positions multiplied by 150 lbs. (68 kg) plus the rated cargo and luggage load.

Vehicle Maximum Load on the Tire Load on an individual tire due to curb and accessory weight plus maximum occupant and cargo weight.

Vehicle Normal Load on the Tire Load on an individual tire that is determined by distributing to each axle its share of the curb weight, accessory weight, and normal occupant weight and dividing by 2.

Vehicle Placard A label permanently attached to a vehicle showing the original equipment tire size and recommended inflation pressure.

All season tires

Kia specifies all season tires on some models to provide good performance for use all year round, including snowy and icy road conditions.

All season tires are identified by ALL SEASON and/or M+S (Mud and Snow) on the tire sidewall. Snow tires have better snow traction than all season tires and may be more appropriate in some areas.

Summer tires

Kia specifies summer tires on some models to provide superior performance on dry roads.

Summer tire performance is substantially reduced in snow and ice. Summer tires do not have the tire traction rating M+S (Mud and Snow) on the tire side wall. If you plan to operate your vehicle in snowy or icy conditions, Kia recommends the use of snow tires or all season tires on all four wheels.

Snow tires

If you equip your vehicle with snow tires, they should be the same size and have the same load capacity as the original tires.

Snow tires should be installed on all four wheels; otherwise, poor handling may result.

Snow tires should carry 4 psi (28 kPa) more air pressure than the pressure recommended for the standard tires on the tire label on the driver's side of the center pillar, or up to the maximum pressure shown on the tire sidewall, whichever is less.

Do not drive faster than 75 mph (120 km/h) when your vehicle is equipped with snow tires.

WARNING

Do not use summer tires at temperatures below 45 °F (7 °C) or when driving on snow or ice. At temperatures below 45 °F (7 °C), summer tires can lose elasticity, and therefore traction and braking power as well. Change the tires on your vehicle to winter or all-weather tires of the same size as the standard tires of the vehicle. Both types of tires are identified by the M+S (Mud and Snow) marking. Using summer tires at very cold temperatures could cause cracks to form, thereby damaging the tires permanently.

Tire chains

Tire chains, if necessary, should be installed on the front wheels.

Be sure that the chains are installed in accordance with the manufacturer's instructions.

To minimize tire and chain wear, do not continue to use tire chains when they are no longer needed.

- When driving on roads covered with snow or ice, drive at less than 20 mph (30 km/h).
- Use the SAE "S" class or wire chains.
- If you hear noise caused by chains contacting the body, retighten the chain to avoid contact with the vehicle body.
- To prevent body damage, retighten the chains after driving 0.3~0.6 miles (0.5~1.0 km).
- Do not use tire chains on vehicles equipped with aluminum wheels. In unavoidable circumstance, use a wire type chain.
- Use wire chains less than 0.47 inches (12 mm) to prevent damage to the chain's connection.

Radial-ply tires

Radial-ply tires provide improved tread life, road hazard resistance and smoother high speed ride.

The radial-ply tires used on this vehicle are of belted construction, and are selected to complement the ride and handling characteristics of your vehicle. Radial-ply tires have the same load carrying capacity, as bias-ply or bias belted tires of the same size, and use the same recommended inflation pressure.

Mixing of radial-ply tires with bias-ply or bias belted tires is not recommended. Any combinations of radial-ply and bias-ply or bias belted tires when used on the same vehicle will seriously deteriorate vehicle handling. The best rule to follow is: Identical radial-ply tires should always be used as a set of four.

Longer wearing tires can be more susceptible to irregular tread wear. It is very important to follow the tire rotation interval shown in this section to achieve the tread life potential of these tires. Cuts and punctures in radial-ply tires are repairable only in the tread area, because of sidewall flexing. Consult your tire dealer for radial-ply tire repairs.

Low aspect ratio tire (if equipped)

Low aspect ratio tires, whose aspect ratio is lower than 50, are provided for sporty looks.

Because the low aspect ratio tires are optimized for handling and braking, it may be more uncomfortable to ride in and there is more noise compare with normal tires.

⚠ CAUTION

Because the sidewall of the low aspect ratio tire is shorter than the normal, the wheel and tire of the low aspect ratio tire is easier to be damaged. So, follow the instructions below.

- When driving on a rough road or off road, drive cautiously because tires and wheels may be damaged. And after driving, inspect tires and wheels.
 - When passing over a pothole, speed bump, manhole, or curb stone, drive slowly so that the tires and wheels are not damaged.
 - If the tire is impacted, we recommend that you inspect the tire condition or contact an authorized Kia dealer.
 - To prevent damage to the tire, inspect the tire condition and pressure every 1,900 miles (3,000 km).
- It is not easy to recognize the tire damage with your own eyes. But if there is the slightest hint of tire damage, even though you cannot see the tire damage with your own eyes, have the tire checked or replaced because the tire damage may cause air leakage from the tire.
 - If the tire is damaged by driving on a rough road, off road, pothole, manhole, or curb stone, it will not be covered by the warranty.
 - You can find out the tire information on the tire sidewall.

Fuses

A vehicle's electrical system is protected from electrical overload damage by fuses.

Blade type



Cartridge type



Multi fuse



BFT



* Left side: Normal, Right side: Blown

This vehicle has 2 (or 3) fuse panels, one located in the driver's side panel bolster, the other in the motor compartment near the battery.

If any of your vehicle's lights, accessories, or controls do not work, check the appropriate circuit fuse. If a fuse has blown, the element inside the fuse will melt.

If the electrical system does not work, first check the driver's side fuse panel.

If the replacement fuse blows, this indicates an electrical problem. Avoid using the system involved and immediately consult an authorized Kia dealer.

Three kinds of fuses are used: blade type for lower amperage rating, cartridge type, and multi fuse for higher amperage ratings.

⚠ WARNING

Fuse replacement

- Never replace a fuse with anything but another fuse of the same rating.
- A higher capacity fuse could cause damage and possibly a fire.
- Never install a wire or aluminum foil instead of the proper fuse - even as a temporary repair. It may cause extensive wiring damage and a possible fire.
- Do not arbitrarily modify or add-on electric wiring to the vehicle.

*** NOTICE**

- When replacing a fuse, change POWER button to the OFF position and turn off switches of all electrical devices then remove battery (-) terminal.
 - The actual fuse/relay panel label may differ from equipped items.
-

⚠ WARNING**Electrical Fire**

Always ensure replacements fuses and relays are securely fastened when installed. Failure to do so can result in a vehicle fire.

Do not remove fuses, relays and terminals fastened with bolts or nuts. The fuses, relays and terminals may be fastened incompletely, and it may cause a possible fire. If fuses, relays and terminals fastened with bolts or nuts are blown, we recommend that you consult with an authorized Kia dealer.

⚠ CAUTION

- When replacing a blown fuse or relay, make sure the new fuse or relay fits tightly into the clips. Failure to tightly install the fuse or relay may cause damage to the wiring and electric systems.
-

⚠ CAUTION

- Do not input any other objects except fuses or relays into fuse/relay terminals such as a screwdriver or wiring. It may cause contact failure and system malfunction.
 - Do not plug in screwdrivers or aftermarket wiring into the terminal originally designed for fuse and relays only. The electrical system and wiring of the vehicle interior may be damaged or burned due to contact failure.
 - If you directly connect the wire on the taillight or replace the bulb which is over the regulated capacity to install trailers etc., the inner junction block can get burned.
-

⚠ WARNING**Electrical wiring repairs**

All electrical repairs should be performed by an authorized Kia dealership using approved Kia parts. Using other wiring components, especially when retrofitting multimedia or theft alarm system, car phone or radio may cause vehicle damage and increase the risk of a vehicle fire.

* NOTICE

Remodeling Prohibited

Do not rewire your vehicle in any way as doing so may affect the performance of several safety features in your vehicle. Rewiring your vehicle may also void your warranty and cause you to be responsible for any subsequent vehicle damage which may result.

Replacing inner panel fuse

1. Turn the POWER button and all other switches off.
2. Open the fuse panel cover.



If the switch is located in the "OFF" position, a caution indicator will be displayed in the cluster. To identify the location of a specific fuse, please refer to the inside of the fuse panel cover and the description list in this section.

3. Pull the suspected fuse straight out. Use the removal tool provided on the motor compartment fuse panel cover.



4. Check the removed fuse; replace it if it is blown. Spare fuses are provided in the motor compartment fuse panel.
5. Push in a new fuse of the same rating, and make sure it fits tightly in the clips.

If it fits loosely, consult an authorized Kia dealer.

If you do not have a spare, use a fuse of the same rating from a circuit you may not need for operating the vehicle, such as the power outlet fuse.

If the head lamp, turn signal lamp, stop signal lamp, fog lamp, DRL, tail lamp, HMSL do not work and the fuses are OK, check the fuse panel in the motor compartment. If a fuse is blown, it must be replaced.

* NOTICE

If the headlamp, fog lamp, turn signal lamp, or tail lamp malfunction even without any problem to the lamps, have the vehicle checked by an authorized Kia dealer for assistance.

Fuse switch



ODEEV098035NR

Always set the fuse switch to the ON position before using the vehicle. If you move the switch to the OFF position, some items such as audio and digital clock must be reset and transmitter (or smart key) may not work properly. When the switch is Off, the caution indicator will be displayed on the instrument cluster.

⚠ CAUTION

Fuse Panel Covers

The contact points of the switches may wear out with excessive use. Please refrain from excessive use of the switches (except for long-term parking for over 1 month).

* NOTICE

- If the vehicle is going to be unused for over 1 month, set all switches to OFF to prevent the batteries from draining.

Replacing motor compartment fuse

1. Turn the POWER button and all other switches off.
2. Remove the fuse panel cover by pressing the tab and pulling the cover up.



ODEEV098036NR

3. Check the removed fuse; replace it if it is blown. To remove or insert the fuse, use the fuse puller in the motor compartment fuse panel.

4. Push in a new fuse of the same rating, and make sure it fits tightly in the clips. If it fits loosely, consult an authorized Kia dealer.

⚠ CAUTION

Always securely install the fuse panel cover in the motor compartment to protect against electrical failure which may occur from water contact. Listen for the audible clicking sound to ensure fuse panel cover is securely fastened.

Multi fuse



ODEEV098037NR

If the multi fuse is blown, it must be removed as follows:

1. Turn the POWER button and all other switches off.
2. Disconnect the negative battery cable.
3. Remove the nuts shown in the picture above.
4. Replace the fuse with a new one of the same rating.
5. Reverse these steps to reinstall the multi fuse.

* NOTICE

Do not disassemble nor assemble the multi fuse when it is secured with nuts and bolts. Incorrect or partial assembly torque may cause a fire. Have the vehicle checked by an authorized Kia dealer

Main fuse



ODEEV098038NR

If the main fuse is blown, it must be removed as follows:

1. Turn the POWER button and all other switches off.
2. Disconnect the negative battery cable.
3. Remove the nuts shown in the picture above.
4. Replace the fuse with a new one of the same rating.
5. Reverse these steps to reinstall the multi fuse.

*** NOTICE**

The electronic system may not function correctly even when the motor compartment and internal fuse box's individual fuses are not disconnected. In such case the cause of the problem may be disconnection of the main fuse (BFT type), which is located inside the positive battery terminal (+) cap.

Since the main fuse is designed more intricately than other parts, have the vehicle checked by an authorized Kia dealer.

Fuse/relay panel description

Inside the fuse/relay panel covers, you can find the fuse/relay label describing fuse/relay name and capacity.

Driver's side fuse panel



ODEEV098039NR

*** NOTICE**

Not all fuse panel descriptions in this manual may be applicable to your vehicle. It is accurate at the time of printing. When you inspect the fuse panel in your vehicle, refer to the fuse panel label on the inside of the fuse cover. This diagram will provide you with the specific information for your vehicles.

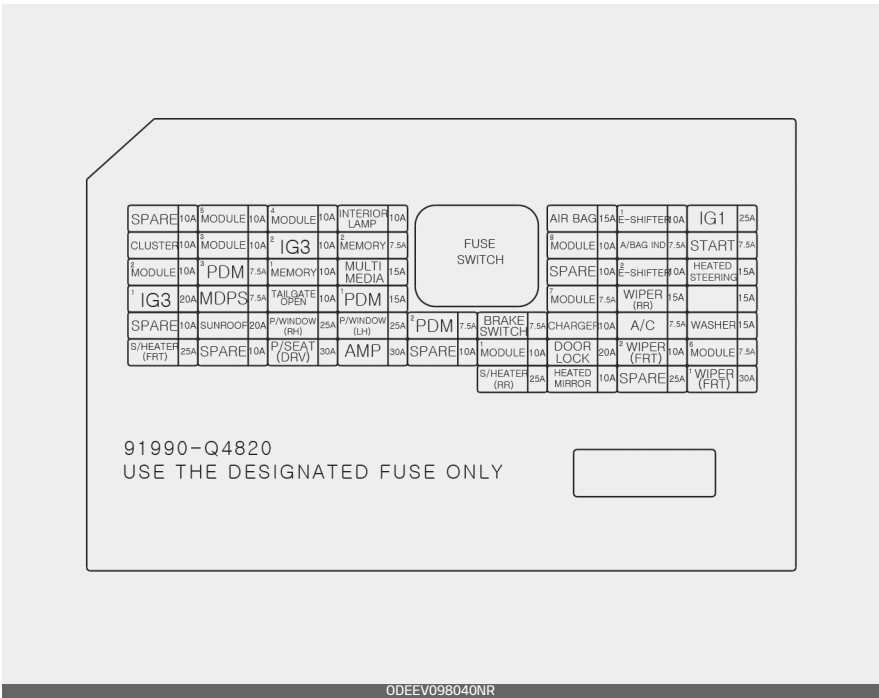

ODEEV098040NR

Refer to the following table for a description of the fuse.

Fuse Name	Fuse rating	Circuit Protected
MODULE 5	10 A	Crash Pad Switch, ECM (Electro Chromic Mirror), Audio / Video & Navigation Head Unit, Head Lamp Leveling Device Actuator LH/RH, Front Seat Warmer Control Module, Rear Seat Warmer Control Module, Auto Head Lamp Leveling Device Module, Front Air Ventilation Seat Control Module Amp
MODULE 4	10 A	Crash Pad Switch, MFC Module AEB module, Blind Spot Detection Radar Left Handle side / Right Handle side, VESS console upper EXTN (STR'G WHEEL HEATED)
INTERIOR LAMP	10 A	Luggage Lamp, Front Vanity Lamp LH/RH, Room, Overhead Console Lamp Rain Sensor, Wireless Charger
A/BAG	15 A	ACU (Airbag Control Unit), ODS
E-SHIFTER 1	10 A	Console Upper EXTN (SBW)
IG 1	25 A	PCB Block (FUSE-IEB2, EPCU2)
CLUSTER	10 A	Cluster
MODULE 3	10 A	BCM (Body Control Module), Driver/Passenger Door Module, Stop Lamp Switch
IG3_2	10 A	Fuel Filler Door & Battery Charge Switch, Cluster, Charger Indicator, Air Conditioner Control Module, Audio / Video & Navigation Head Unit, Audio, IG3, PTC Heater Charger Control Module
MEMORY 2	7.5 A	VESS, BATT_COOL_EXV
A/BAG IND	7.5 A	Cluster, Air Conditioner Control Module
START	7.5 A	EPCU, Smart Key Control Module
MODULE 2	10 A	O/S Mirror, Power Outlet Relay, Amp, BCM (Body Control Module), Wireless Charge Unit, USB/Charge Unit, Smart Key Control Module, Audio Unit
BUTTON START 3	7.5 A	Smart Key Control Module

Fuse Name	Fuse rating	Circuit Protected
MEMORY 1	10 A	Driver/Passenger Door Module, IMS (Driver Integrated Memory System Module), Cluster, Air Conditioner Control Module, ECM (Electro Chromic Mirror), Auto Light & Photo Sensor, BCM (Body Control Module), Active Air Flap Unit
MULTI MEDIA	15 A	Audio / Video & Navigation Head Unit
E-SHIFTER 2	10 A	SBW Control Unit
HEATED STEERING	15 A	BCM (Body Control Module)
IG3_1	20 A	IG3_1 Relay
MDPS	7.5 A	MDPS Unit
TAIL GATE	10 A	Tail Gate Relay
BUTTON START 1	15 A	Smart Key Control Module
MODULE 7	7.5 A	Front Seat Warmer Control Module / Front Air Ventilation Seat Control Module, Rear Seat Warmer Control Module, AC Inverter Module
WIPER (REAR)	15 A	Engine Room Junction Block (Rear Wiper Relay), Rear Wiper Motor
SUNROOF	20 A	Sunroof Motor
P/WINDOW RH	25 A	Power Window Right Handle Side Relay, Passenger Safety Power Window Module (LHD), Driver Safety Power Window Module (RHD)
P/WINDOW LH	25 A	Power Window Right Handle Side Relay, Passenger Safety Power Window Module (LHD), Passenger Safety Power Window Module (RHD)
BUTTON START 2	7.5 A	Start/Stop Button Switch, Smart Key Control Module
BRAKE SWITCH	7.5 A	Stop Lamp Switch, Smart Key Control Module
CHARGER	10 A	Charge Control Module, Charger Lock/Unlock Relay, C_C_Lamp
A/CON	7.5 A	Air Conditioner Control Module, Ionizer
WASHER	15 A	Multifunction Switch
S/HEATER (FRT)	25 A	Front Seat Warmer Control Module
P/SEAT (DRV)	30 A	Driver Seat Manual Switch, Driver Integrated Memory System Module

Fuse Name	Fuse rating	Circuit Protected
AMP	30 A	AMP
MODULE 1	10 A	Hazard Switch, BCM (Body Control Module), OBD, Driver Smart Key Outside Handle, Passenger Smart Key Outside Handle, Driver Door Module, Passenger Door Module
DOOR LOCK	20 A	Door Lock/Unlock Relay, ICM Relay Box (Dead Lock Relay)
WIPER 2 (FRT)	10 A	BCM (Body Control Module), Wiper Motor, Engine Room Junction Block (Front Wiper (Low) Relay)
MODULE 6	7.5 A	BCM (Body Control Module), Smart Key Control Module
S/HEATER (REAR)	25 A	Rear Seat Warmer Control Module
HEATED MIRROR	10 A	Driver/Passenger Power Outside Mirror, Air conditioner Control Module
WIPER 1 (FRT)	30 A	Wiper Motor, Engine Room Junction Block (Front Wiper (LOW) Relay)

Motor compartment fuse panel



ODEEV098041NR

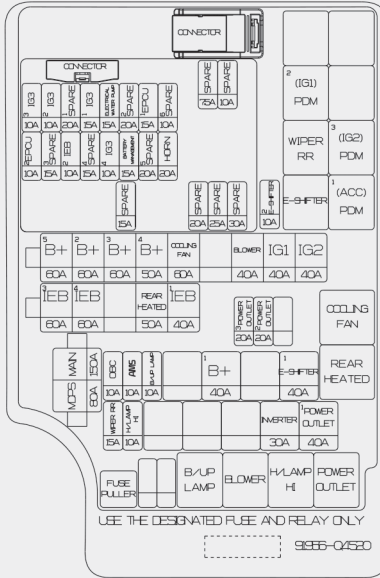

ODEEV098042NR

Refer to the following table for a description of the fuse.

Fuse Name		Fuse rating	Circuit Protected
MUTL FUSE	B + 5	60 A	PCB-Block (Fuse -EPCU1, BMS, B/Alarm Horn, Horn Relay - Main)
	B + 2	60 A	IGPM (Fuse - S/HEATER (REAR), ARISU (4CH), IPS (2CH), IPS (2CH)
	B + 3	60 A	IGPM (ARISU (4CH), IPS (2CH), IPS (2CH), IPS (2CH), IPS (1CH)
	B + 4	50 A	IGPM (Fuse - Tail Gate, Sunroof, P/window RH, P/window LH. S/Heater (FRT), P/Seat (DRV), AMP, IG3_1
	COOLING FAN 1	60 A	Cooling Fan Relay
	BLOWER	40 A	Blower Relay
	IG 1	40 A	Button Start #2 (IG1) Relay, Button Start #1 (ACC) Relay
	IG 2	40 A	Button Start #3 (IG2) Relay
	IEB 3	60 A	IDB_MTR+2
	IEB 4	60 A	IDB_MTR+1
	REAR HEATED	50 A	Rear Heated Relay
	IEB 1	40 A	IDB Unit
MAIN	150 A	Fuse - Power Outlet 1, AC Inverter Module, Head Lamp (high), Rear Wiper	

Fuse Name	Fuse rating	Circuit Protected
MDPS	80 A	MDPS Unit
E-SHIFTER 2	10 A	E-SHIFTER Relay
POWER OUTLET 3	20 A	P/OUTLET Relay
POWER OUTLET 2	20 A	P/OUTLET Relay
OBC	10 A	OBC Unit
AMS	10 A	Battery SNSR
B/UP LMAP	10 A	B/UP LAMP Relay
B + 1	40 A	IGPM (Fuse - BUTTON START 1, BUTTON START 2, BRAKE SWITCH, MODULE 1 DOOR LOCK leak current Autocut Device)
E-SHIFTER 1	40 A	E-SHIFTER 1 Relay
REAR WIPER	15 A	Rear Wiper Relay
HEAD LAMP HI	10 A	H/LAMP HI Relay
INVERTER	30 A	AC Inverter Module
POWER OUTLET 1	40 A	Power Outlet Relay
IG3_2	10 A	OBC Unit
EWP	15 A	Electric Water Pump (Battery), Electric Water Pump (PE)
IG3_3	10 A	Cooling Fan Relay, E-Compressor, Blow Relay, EPCU
IG3_4	10 A	BMS Unit, Active Air Flap Unit, 3 WAY_VALVE (RH/LH), B/UP LP Relay
IG3_1	15 A	IG3_1 Relay
EPCU 1	15 A	EPCU
BMS	15 A	BMS Unit
B/ALARM HORN	10 A	B/ALARM HORN Relay
HORN	20 A	HORN Relay
IEB 2	10 A	IDB Unit, Multipurpose Check Connector
EPCU 2	10 A	EPCU

FUSE

Refer to the following table for the relay type.

Relay Name	Type
Button Start #2 (IG1) Relay	MICRO
Rear Wiper Relay	MICRO
Button Start #3 (IG2) Relay	MICRO
E-SHIFTER Relay	MICRO
Button Start #1 (ACC) Relay	MICRO
Cooling Fan Relay	MINI
Rear Heated Relay	MINI
B/UP Lamp Relay	MICRO
Blower Relay	MICRO
HEAD LAMP HI Relay	MICRO
Power Outlet Relay	MICRO

Battery terminal cover



*** NOTICE**

Not all fuse panel descriptions in this manual may be applicable to your vehicle. It is accurate at the time of printing. When you inspect the fuse panel in your vehicle, refer to the fuse panel label.

ODEEV098043NR

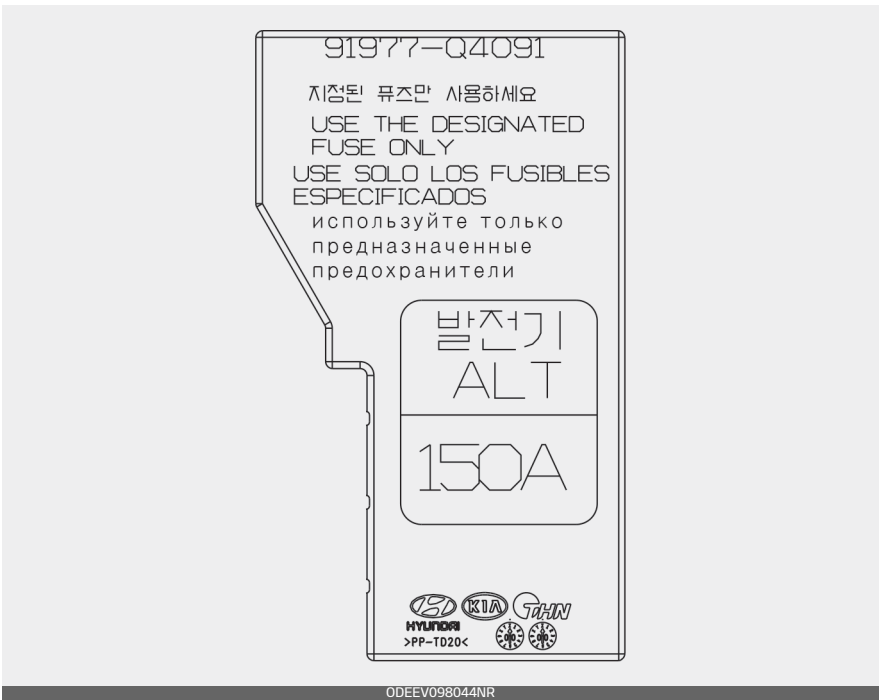

ODEEV098044NR

8

Light bulbs

Light bulbs are installed in various parts of the vehicle to provide lighting inside and outside the vehicle as well as to alert other vehicles.

Bulb replacement precaution

Please keep extra bulbs on hand with appropriate wattage ratings in case of emergencies.

Refer to "Bulb wattage" on page 9-3.

When changing lamps, first turn off the vehicle at a safe place, firmly apply the parking brake and detach the battery's negative (-) terminal.

WARNING

Working on the lights

Prior to working on the light, firmly apply the parking brake, ensure that the vehicle POWER button is in OFF position and turn off the lights to avoid sudden movement of the vehicle and burning your fingers or receiving an electric shock.

Use only bulbs of the specified wattage.

CAUTION

Light replacement

Be sure to replace the burned-out bulb with one of the same wattage rating. Otherwise, it may cause damage to the fuse or electric wiring system.

CAUTION

Headlamp Lens

To prevent damage, do not clean the headlamp lens with chemical solvents or strong detergents.

NOTICE

- If the light bulb or lamp connector is removed while the lamp is still on, the fuse box's electronic system may log it as a malfunction. Therefore, a lamp malfunction incident may be recorded as a Diagnostic Trouble Code (DTC) in the fuse box.
- It is normal for an operating lamp to flicker momentarily. This is due to a stabilization function of the vehicle's electronic control device. If the lamp lights up normally after momentarily blinking, then it is functioning as normal. However, if the lamp continues to flicker several times or turns off completely, there may be an error in the vehicle's electronic control

device. Please have the vehicle checked by an authorized Kia dealer immediately.

* NOTICE

We recommend that the headlight aiming be adjusted by an authorized Kia dealer after an accident or after the headlight assembly is reinstalled.

* NOTICE

After driving in heavy rain or washing, headlamp and tail lamp lenses could appear frosty. This condition is caused by the temperature difference between the lamp inside and outside. This is similar to the condensation on your windows inside your vehicle during the rain and doesn't indicate a problem with your vehicle. If the water leaks into the lamp bulb circuitry, we recommend that you have the vehicle checked by an authorized Kia dealer.

If you don't have the necessary tools, the correct bulbs and the expertise, consult an authorized Kia dealer. In many cases, it is difficult to replace vehicle light bulbs because other parts of the vehicle must be removed before you can get to the bulb. This is especially true if you have to remove the

headlamp assembly to get to the bulb(s).

Removing/installing the headlamp assembly can result in damage to the vehicle. If non-genuine parts or substandard bulbs are used, it may lead to blowing a fuse or other wiring damages.

Do not install extra lamps or LEDs to the vehicle. If additional lights are installed, it may lead to lamp malfunctions and flickering. Additionally, the fuse box and other wiring may be damaged.

Light bulb position (Front)

Head lamp - Type A

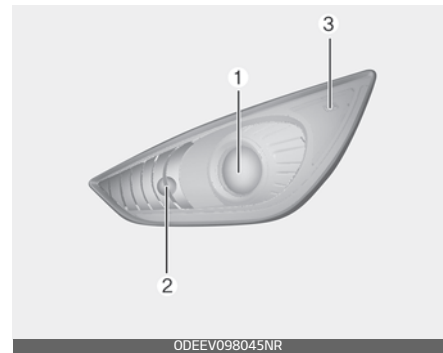

Head lamp - Type B

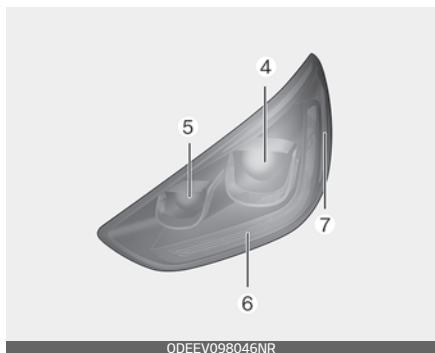

ODEEV098046NR

Fog lamp

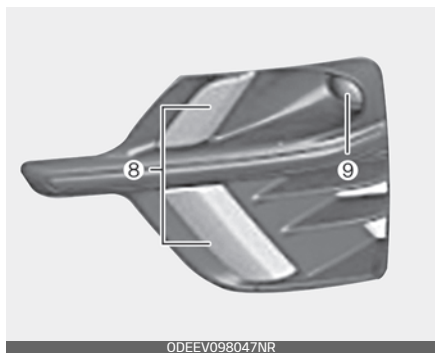

ODEEV098047NR

Light bulb position (Rear)

Rear combination lamp

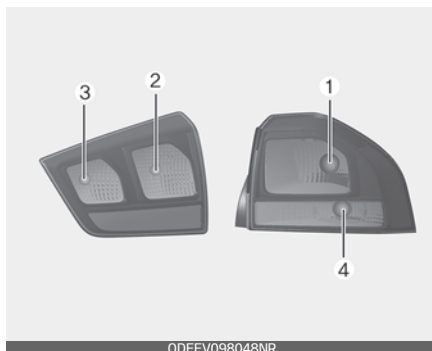

ODEEV098048NR

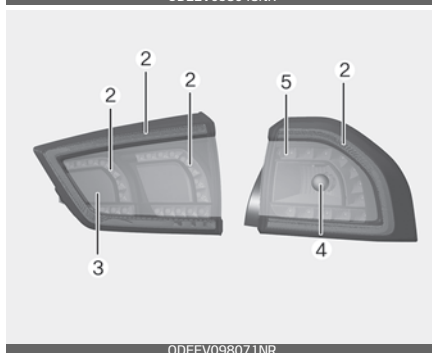

ODEEV098071NR

Back up lamp



ODEEV098049NR

- 1. Headlamp (Low/High) (Bulb type)
- 2. Front turn signal lamp (Bulb type)
- 3. Side marker (Bulb type)
- 4. Headlamp (Low/High) (LED type)
- 5. Headlamp (Low) (LED type)
- 6. Front turn signal lamp (LED type)
- 7. Side marker (LED type)
- 8. Day time running lamp / Position lamp (LED type)
- 9. Front fog lamp (Bulb type)

High mounted stop lamp



ODEEV098050NR

License plate lamp



ODEEV098051NR

1. Stop/tail lamp (Bulb type)
2. Tail lamp (Bulb/LED type)
3. Rear fog lamp (LED type)
4. Rear turn signal lamp
5. Stop/tail lamp (LED type)
6. Back up lamp (Bulb type)
7. High mounted stop lamp (LED type)
8. License plate lamp (Bulb type)

Light bulb position (Side)



ODEEV098052NR

1. Side repeater lamp (LED type)

Replacing headlamp (LED type)

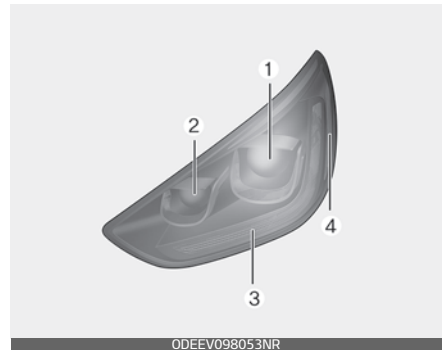

ODEEV098053NR

If the Low/High beam lamp (1), Low beam lamp (2), Front turn signal lamp (3), or side marker (4) does not operate, have the vehicle checked by an authorized Kia dealer.

The LED lamps cannot be replaced as a single component because they are part of an integrated unit. The LED lamps have to be replaced with the unit.

A skilled technician should check or repair the head lamp (LED), for it may damage related parts of the vehicle.

Replacing headlamp (high/low beam) bulb



ODEEV098054NR

1. Open the hood.
2. Remove the headlamp bulb cover by turning it counterclockwise.
3. Disconnect the headlamp bulb socket-connector.
4. Remove the bulb-socket from the headlamp assembly by turning the bulb-socket counterclockwise until the tabs on the bulb-socket align with the slots on the headlamp assembly.
5. Install a new bulb-socket assembly in the headlamp assembly by aligning the tabs on the bulb-socket with the slots in the headlamp assembly.
6. Push the bulb-socket into the headlamp assembly and turn the bulb-socket clockwise.
7. Install the headlamp bulb cover by turning it clockwise.

Headlamp bulb



ODEEV098055NR

⚠ WARNING

Halogen bulbs

Handle halogen bulbs with care.

- Halogen bulbs contain pressurized gas that will produce flying pieces of glass if broken.
 - Avoid scratches and abrasions to the halogen bulbs. If the bulbs are lit, avoid contact with liquids.
-
- Always handle them carefully, and avoid scratches and abrasions. If the bulbs are lit, avoid contact with liquids. Never touch the glass with bare hands. Residual oil may cause the bulb to overheat and burst when lit. A bulb should be operated only when installed in a headlamp.
 - If a bulb becomes damaged or cracked, replace it immediately and carefully dispose of it.
 - Wear eye protection when changing a bulb. Allow the bulb to cool down before handling it.

Replacing front turn signal lamp bulb



ODEEV098056NR

1. Open the hood.
2. Remove the dust cover (A) from the headlamp assembly then the bulb-socket by turning it counterclockwise until the tabs on the bulb-socket align with the slots on the headlamp assembly.
3. Remove the bulb from the bulb-socket by pressing it in and rotating it counterclockwise until the tabs on the bulb align with the slots in the bulb-socket. Pull the bulb out of the bulb-socket.
4. Insert a new bulb by inserting it into the bulb-socket and rotating it until it locks into place.
5. Install the socket in the headlamp assembly by aligning the tabs on the bulb-socket with the slots in the assembly. Push the bulb-socket into the headlamp assembly and turn the socket clockwise.

Replacing fog lamp/DRL/position lamp bulb

If the front fog lamp (Bulb) and DRL bulb (LED) does not operate, have the vehicle checked by an authorized Kia dealer.



ODEEV098057NR

The LED lamps cannot be replaced as a single component because they are part of an integrated unit. The LED lamps have to be replaced with the unit.

A skilled technician should check or repair the front fog lamp (Bulb) and DRL bulb (LED), for it may damage related parts of the vehicle.

Replacing stop and tail lamp (rear bulb type) bulb

1. Open the liftgate.
2. Open the service cover.
3. Loosen the light assembly retaining screws with a cross-tip screwdriver.



4. Remove the rear combination lamp assembly from the body of the vehicle.



5. Disconnect the rear combination lamp connector.

6. Remove the socket from the assembly by turning the socket counterclockwise until the tabs on the socket align with the slots on the assembly.



7. Remove the bulb from the socket by pressing it in and rotating it counterclockwise until the tabs on the bulb align with the slots in the socket. Pull the bulb out of the socket.
8. Insert a new bulb by inserting it into the socket and rotating it until it locks into place.
9. Install the socket in the assembly by aligning the tabs on the socket with the slots in the assembly. Push the socket into the assembly and turn the socket clockwise.
10. Install the rear combination lamp assembly to the body of the vehicle.
11. Install the service cover.

Replacing tail lamp (inside) bulb

1. Open the liftgate.
2. Remove the service cover.

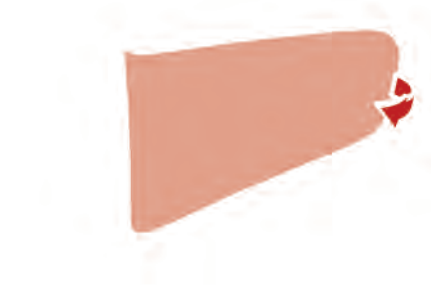

ODEEV098075NR

3. Remove the socket from the assembly by turning the socket counterclockwise until the tabs on the socket align with the slots on the assembly.



ODEEV098076NR

4. Remove the bulb from the socket by pressing it in and rotating it counter-clockwise until the tabs on the bulb align with the slots in the socket. Pull the bulb out of the socket.
5. Insert a new bulb by inserting it into the socket and rotating it until it locks into place.

6. Install the socket in the assembly by aligning the tabs on the socket with the slots in the assembly. Push the socket into the assembly and turn the socket clockwise.
7. Install the service cover by putting it into the service hole.

Replacing stop and tail lamp (LED type) bulb

If the stop and tail lamp (LED) does not operate, have the vehicle checked by an authorized Kia dealer.



ODEEV098058NR

The LED lamps cannot be replaced as a single component because they are part of an integrated unit. The LED lamps have to be replaced with the unit.

A skilled technician should check or repair the stop and tail lamp (LED), for it may damage related parts of the vehicle.

Replacing back-up lamp bulb

If the back-up lamp does not operate, have the vehicle checked by an authorized Kia dealer.



ODEEV098059NR

Replacing high mounted stop lamp bulb

If the high mounted stop lamp (LED) does not operate, have the vehicle checked by an authorized Kia dealer.



ODEEV098060NR

The LED lamps cannot be replaced as a single component because they are part of an integrated unit. The LED lamps have to be replaced with the unit.

A skilled technician should check or repair the high mounted stop lamp (LED), for it may damage related parts of the vehicle.

Replacing license plate lamp bulb



ODEEV098061NR



ODEEV098062NR

1. Using a flat-blade screwdriver, gently pry the lens cover from lamp housing.
2. Remove the socket from the assembly by turning the socket counterclockwise until the tabs on the socket align with the slots on the assembly.
3. Remove the bulb from bulb-socket by pulling it out.

4. Insert a new bulb by inserting it into the bulb-socket.
5. Install the socket in the assembly by aligning the tabs on the socket with the slots in the assembly.
6. Push the socket into the assembly and turn the socket clockwise.
7. Align the lens cover tabs with the lamp housing notches and snap the lens into place.

Replacing side repeater lamp (LED type) bulb

If the side repeater lamp (LED) does not operate, have the vehicle checked by an authorized Kia dealer.



ODEEV098052NR

The LED lamps cannot be replaced as a single component because they are part of an integrated unit. The LED lamps have to be replaced with the unit.

A skilled technician should check or repair the side repeater lamp (LED), for it may damage related parts of the vehicle.

Replacing map lamp (bulb type) bulb



ODEEV098063NR

1. Using a flat-blade screwdriver, gently pry the lens cover from lamp housing.
2. Remove the bulb by pulling it straight out.
3. Install a new bulb in the socket.
4. Align the lens cover tabs with the lamp housing notches and snap the lens into place.

* NOTICE

Be careful not to dirty or damage the lens, lens tab, and plastic housings.

Replacing map lamp (LED type) bulb

If the map lamp (LED) does not operate, have the vehicle checked by an authorized Kia dealer.



ODEEV098064NR

The LED lamps cannot be replaced as a single component because they are part of an integrated unit. The LED lamps have to be replaced with the unit.

A skilled technician should check or repair the map lamp (LED), for it may damage related parts of the vehicle.

Replacing vanity mirror lamp bulb



ODEEV098065NR

⚠ WARNING

Interior lamps

Prior to working on the Interior lamps, ensure that the "OFF" button is depressed to avoid burning your fingers or receiving an electric shock.

1. Using a flat-blade screwdriver, gently pry the lamp assembly from interior.
2. Remove the bulb by pulling it straight out.
3. Install a new bulb in the socket.
4. Install the lamp assembly to interior.

*** NOTICE**

Be careful not to dirty or damage the lens, lens tab, and plastic housings.

Replacing room lamp (bulb type) bulb



ODEEV098066NR

⚠ WARNING

Interior lamps

Prior to working on the Interior lamps, ensure that the "OFF" button is depressed to avoid burning your fingers or receiving an electric shock.

1. Using a flat-blade screwdriver, gently pry the lens cover from lamp housing.
2. Remove the bulb by pulling it straight out.
3. Install a new bulb in the socket.
4. Align the lens cover tabs with the lamp housing notches and snap the lens into place.

* NOTICE

Be careful not to dirty or damage the lens, lens tab, and plastic housings.

Replacing room lamp (LED type) bulb

If the Room lamp (LED) does not operate, have the vehicle checked by an authorized Kia dealer.



ODEEV098067NR

The LED lamps cannot be replaced as a single component because they are part of an integrated unit. The LED lamps have to be replaced with the unit.

A skilled technician should check or repair the Room lamp (LED), for it may damage related parts of the vehicle.

Replacing liftgate room lamp bulb



ODEEV098068NR

1. Using a flat-blade screwdriver, gently pry the lens cover from lamp housing.
2. Remove the bulb by pulling it straight out.
3. Install a new bulb in the socket.
4. Align the lens cover tabs with the lamp housing notches and snap the lens into place.

If the Liftgate room lamp (LED) does not operate, have the vehicle checked by an authorized Kia dealer.

The LED lamps cannot be replaced as a single component because they are part of an integrated unit. The LED lamps have to be replaced with the unit.

A skilled technician should check or repair the Liftgate room lamp (LED), for it may damage related parts of the vehicle.

* NOTICE

Be careful not to dirty or damage the lens, lens tab, and plastic housings.

Appearance care

Use the information in the following sections to keep the exterior and interior of your vehicle clean.

Exterior care

Use the information in the following sections to maintain the exterior of your vehicle. Keeping the exterior clean is not only aesthetically pleasing, but it also helps to prolong the life of the vehicle.

Exterior general caution

It is very important to follow the label directions when using any chemical cleaner or polish. Read all warning and caution statements that appear on the label.

Finish maintenance

Washing

To help protect your vehicle's finish from rust and deterioration, wash it thoroughly and frequently at least once a month with lukewarm or cold water.

If you use your vehicle for off-road driving, you should wash it after each off-road trip. Pay special attention to the removal of any accumulation of salt, dirt, mud, and other foreign materials. Make sure the drain holes in the lower edges of the doors and rocker panels are kept clear and clean.

Insects, tar, tree sap, bird droppings, industrial pollution and similar deposits can damage your vehicle's finish if not removed immediately. Even prompt washing with plain water may not completely remove all these deposits. A mild soap, safe for use on painted surfaces, may be used.

After washing, rinse the vehicle thoroughly with lukewarm or cold water. Do not allow soap to dry on the finish.

After washing the vehicle, test the brakes while driving slowly to see if they have been affected by water. If braking performance is impaired, dry the brakes by applying them lightly while maintaining a slow forward speed.

⚠ CAUTION

- Do not use strong soap, chemical detergents or hot water, and do not wash the vehicle in direct sunlight or when the body of the vehicle is warm.
- Be careful when washing the side windows of your vehicle, especially with high-pressure water. Water may leak through the windows and wet the interior.
- To prevent damage to the plastic parts and lamps, do not clean with chemical solvents or strong detergents.

High-pressure washing

When using high-pressure washers, make sure to maintain sufficient distance from the vehicle.

Insufficient clearance or excessive pressure can lead to component damage or water penetration.

Do not spray the camera, sensors or its surrounding area directly with a high pressure washer. Shock applied from high pressure water may cause the device to not operate normally.

Do not bring the nozzle tip close to boots (rubber or plastic covers) or connectors as they may be damaged if they come into contact with high pressure water.

⚠ WARNING

After washing the vehicle, test the brakes while driving slowly to see if they have been affected by water. If braking performance is impaired, dry the brakes by applying them lightly while maintaining a slow forward speed.

⚠ CAUTION

Wetting motor compartment



0DEEV098069NR

- Water washing in the motor compartment including high pressure water washing may cause the failure of electrical circuits located in the motor compartment.
 - Never allow water or other liquids to come in contact with electrical/ electronic components inside the vehicle as this may damage them.
 - To prevent damage to the charging door, make sure to close and lock the vehicle doors when washing (high-pressure washing, automatic car washing, etc.) the vehicle.
-

Waxing

Wax the vehicle when water will no longer bead on the paint.

Always wash and dry the vehicle before waxing. Use a good quality liquid or paste wax, and follow the manufacturer's instructions. Wax all metal trim to protect it and to maintain its luster.

Removing oil, tar, and similar materials with a spot remover will usually strip the wax from the finish. Be sure to re-wax these areas even if the rest of the vehicle does not yet need waxing.

⚠ CAUTION

Drying vehicle

- Wiping dust or dirt off the body with a dry cloth will scratch the finish.
- Do not use steel wool, abrasive cleaners, acid detergents or strong detergents containing high alkaline or caustic agents on chrome-plated or anodized aluminum parts. This may result in damage to the protective coating and cause discoloration or paint deterioration.

Finish damage repair

Deep scratches or stone chips in the painted surface must be repaired promptly. Exposed metal will quickly rust and may develop into a major repair expense.

* NOTICE

If your vehicle is damaged and requires any metal repair or replacement, be sure the body shop applies anti-corrosion materials to the parts repaired or replaced.

Bright-metal maintenance

To remove road tar and insects, use a tar remover, not a scraper or other sharp object.

To protect the surfaces of bright metal parts from corrosion, apply a coating of wax or chrome preservative and rub to a high luster.

During winter weather or in coastal areas, cover the bright metal parts with a heavier coating of wax or preservative. If necessary, coat the parts with non-corrosive petroleum jelly or other protective compound.

Underbody maintenance

Road salt and other corrosive chemicals are used in cold weather states to melt snow and prevent ice accumulation. If these chemicals are not regularly removed, they will corrode the vehicle underbody and over time damage fuel lines, the fuel tank retention system, the vehicle suspension, the exhaust system, and even the body frame.

The National Highway Traffic Safety Administration has warned all vehicle owners of all brands of the need to take the following steps:

- Wash the undercarriage of your vehicle regularly during the winter and whenever your vehicle has been exposed to such salts or chemicals.
- Do a thorough washing of the undercarriage at the end of the winter.
- Use professional service technicians or governmental inspection stations to annually inspect for corrosion.
- Immediately seek an inspection of your vehicle if you become visually aware of corrosion flaking or scaling or if you become aware of a change in vehicle performance, such as soft or spongy brakes, fluids leaking, impairment of directional control, suspension noises or rattling metal straps.

Aluminum wheel maintenance

The aluminum wheels are coated with a clear protective finish.

- Do not use any abrasive cleaner, polishing compound, solvent, or wire brushes on aluminum wheels. They may scratch or damage the finish.
- Clean the wheel when it has cooled.

- Use only a mild soap or neutral detergent, and rinse thoroughly with water. Also, be sure to clean the wheels after driving on salted roads. This helps prevent corrosion.
- Avoid washing the wheels with highspeed vehicle wash brushes.
- Do not use any alkaline or acid detergents. It may damage and corrode the aluminum wheels coated with a clear protective finish.

Corrosion protection

Protecting your vehicle from corrosion

By using the most advanced design and construction practices to combat corrosion, we produce vehicles of the highest quality. However, this is only part of the job. To achieve the long-term corrosion resistance your vehicle can deliver, the owner's cooperation and assistance is also required.

Common causes of corrosion

The most common causes of corrosion on your vehicle are:

- Road salt, dirt and moisture that is allowed to accumulate underneath the vehicle.
- Removal of paint or protective coatings by stones, gravel, abrasion or minor scrapes and dents which leave unprotected metal exposed to corrosion.

High-corrosion areas

If you live in an area where your vehicle is regularly exposed to corrosive materials, corrosion protection is particularly important. Some of the common causes of accelerated corrosion are road salts, dust control chemicals, ocean air and industrial pollution.

Moisture breeds corrosion

Moisture creates the conditions in which corrosion is most likely to occur. For example, corrosion is accelerated by high humidity, particularly when temperatures are just above freezing. In such conditions, the corrosive material is kept in contact with the vehicle's surface by moisture that evaporates slowly. Mud is particularly corrosive because it dries slowly and holds moisture in contact with the vehicle. Although the mud appears to be dry, it can still retain the moisture and promote corrosion.

High temperatures can also accelerate corrosion of parts that are not properly ventilated so the moisture can be dispersed. For all these reasons, it is particularly important to keep your vehicle clean and free of mud or accumulations of other materials. This applies not only to the visible surfaces but particularly to the underside of the vehicle.

To help prevent corrosion

You can help prevent corrosion from beginning by observing the following:

Keep your vehicle clean

The best way to prevent corrosion is to keep your vehicle clean and free of corrosive materials. Attention to the underside of the vehicle is particularly important.

If you live in a high-corrosion area — where road salts are used, near the ocean, areas with industrial pollution, acid rain, etc.—, you should take extra care to prevent corrosion. In winter, hose off the underside of your vehicle at least once a month and be sure to clean the underside thoroughly when winter is over.

When cleaning underneath the vehicle, give particular attention to the components under the fenders and other areas that are hidden from view. Do a thorough job; just dampening the accumulated mud rather than washing it away will accelerate corrosion rather than prevent it. Water under high pressure and steam are particularly effective in removing accumulated mud and corrosive materials.

When cleaning lower door panels, rocker panels and frame members, be sure that drain holes are kept open so that moisture can escape and not be trapped inside to accelerate corrosion.

Keep your garage dry

Don't park your vehicle in a damp, poorly ventilated garage. This creates a favorable environment for corrosion. This is particularly true if you wash your vehicle in the garage or drive it into the garage when it is still wet or covered with snow, ice or mud. Even a heated garage can contribute to corrosion unless it is well ventilated so moisture is dispersed.

Keep paint and trim in good condition

Scratches or chips in the finish should be covered with "touch-up" paint as soon as possible to reduce the possibility of corrosion. If bare metal is showing through, the attention of a qualified body and paint shop is recommended.

Bird droppings: Bird droppings are highly corrosive and may damage painted surfaces in just a few hours. Always remove bird droppings as soon as possible.

Don't neglect the interior

Moisture can collect under the floor mats and carpeting and cause corrosion. Check under the mats periodically to be sure the carpeting is dry. Use particular care if you carry fertilizers, cleaning materials or chemicals in the vehicle.

These should be carried only in proper containers and any spills or leaks should be cleaned up, flushed with clean water and thoroughly dried.

Interior care

Use the information in the following sections to maintain the interior of your vehicle.

Interior general precautions

Prevent chemicals such as perfume, cosmetic oil, sun cream, hand cleaner, and air freshener from contacting the interior parts because they may cause damage or discoloration. If they do contact the interior parts, wipe them off immediately. If necessary, use a vinyl cleaner, see product instructions for correct usage.

⚠ CAUTION

Electrical components

Never allow water or other liquids to come in contact with electrical/electronic components inside the vehicle as this may damage them.

▲ CAUTION

Leather

When cleaning leather products (steering wheel, seats etc.), use neutral detergents or low alcohol content solutions. If you use high alcohol content solutions or acid/alkaline detergents, the color of the leather may fade or the surface may get stripped off.

Taking care of leather seats

- Vacuum the seat periodically to remove dust and sand on the seat. It will prevent abrasion or damage of the leather and maintain its quality.
- Wipe the natural leather seat cover often with dry or soft cloth.
- Sufficient use of a leather protective may prevent abrasion of the cover and helps maintain the color. Be sure to read the instructions and consult a specialist when using leather coating or protective agents.
- Leather with bright colors (beige, cream beige) is easily contaminated and clear in appearance. Clean the seats frequently.
- Avoid wiping with wet cloth. It may cause the surface to crack.

Cleaning the leather seats

Remove all contaminations instantly. Refer to instructions below for removal of each contaminant.

- Cosmetic products (sunscreen, foundation, etc.)
 - Apply cleansing cream on a cloth and wipe the contaminated point. Wipe off the cream with a wet cloth and remove water with a dry cloth.
- Beverages (coffee, soft drink, etc.)
 - Apply a small amount of neutral detergent and wipe until contaminations do not smear.
- Oil
 - Remove oil instantly with absorbable cloth and wipe with stain remover for natural leather only.
- Chewing gum
 - Harden the gum with ice and remove gradually.

Fabric seat cover (if equipped)

Please clean the fabric seats regularly with a vacuum cleaner in consideration of fabric material characteristics. If they are heavily soiled with beverage stains, etc., use a suitable interior cleaner. To prevent damage to seat covers, wipe off the seat covers down to the seams with a large wiping motion

and moderate pressure using a soft sponge or microfiber cloth.

Velcro closures on clothing or sharp objects may cause snagging or scratches on the surface of the seats.

Make sure not to rub such objects against the surface.

Cleaning the upholstery and interior trim

Vinyl

Remove dust and loose dirt from vinyl with a whisk broom or vacuum cleaner. Clean vinyl surfaces with a vinyl cleaner.

Fabric

Remove dust and loose dirt from fabric with a whisk broom or vacuum cleaner. Clean with a mild soap solution recommended for upholstery or carpets. Remove fresh spots immediately with a fabric spot cleaner. If fresh spots do not receive immediate attention, the fabric can be stained and its color can be affected. Also, its fire-resistant properties can be reduced if the material is not properly maintained. Using anything but recommended cleaners and procedures may affect the fabric's appearance and fire-resistant properties.

Cleaning the lap/shoulder belt webbing

Clean the belt webbing with any mild soap solution recommended for cleaning upholstery or carpet. Follow the instructions provided with the soap. Do not bleach or re-dye the webbing because this may weaken it.

Cleaning the interior window glass

If the interior glass surfaces of the vehicle become fogged (that is, covered with an oily, greasy or waxy film), they should be cleaned with a glass cleaner. Follow the directions on the glass cleaner container.

⚠ CAUTION

Rear window

Do not scrape or scratch the inside of the rear window. This may result in damage of the rear window defroster grid.

California perchlorate notice

Perchlorate Material-special handling may apply, See www.dtsc.ca.gov/hazardouswaste/perchlorate.

Notice to California Vehicle Dismantlers: Perchlorate containing materials, such as air bag inflators, seatbelt pre-tensioners and keyless remote entry batteries, must be disposed of according to Title 22 California Code of Regulations Section 67384.10 (a).

Specifications, Consumer information and Reporting safety defects

Dimensions.....	9-2
Electric vehicle specifications	9-2
Bulb wattage	9-3
Tires and wheels	9-4
Volume and weight.....	9-5
Air conditioning system	9-5
Recommended lubricants and capacities	9-5
Vehicle identification number (VIN).....	9-6
Vehicle certification label	9-6
Tire specification and pressure label.....	9-7
Motor number	9-7
Air conditioner compressor label	9-8
Refrigerant label.....	9-8
Consumer Assistance (U.S. only).....	9-9
Electrical Equipment (U.S. only)	9-11
Reporting Safety Defects (U.S. only)	9-12
Online factory authorized manuals (U.S. only).....	9-13

SPECIFICATIONS, CONSUMER INFORMATION AND REPORTING SAFETY DEFECTS

Dimensions

Item		Size: in (mm)	
Overall length		172.2 (4,375)	
Overall width		71.1 (1,805)	
Overall height	Without Roof rack	61.4 (1,560)	
	With Roof rack	61.8 (1,570)	
Tread	Front	215/55R17	61.5 (1,562)
	Rear	215/55R17	61.9 (1,572)
Wheelbase		106.3 (2,700)	

Electric vehicle specifications

Motor		Battery (Lithium-Ion Polymer)			Charger (OBC)
Max. Output	Max. Torque	Capacity	Power Output	Voltage	Max. Output
150 kW	395 N·m	180 Ah	170 kW	356 V	7.2 kW

OBC: On-Board Battery Chargers

Bulb wattage

Light Bulb		Wattage (W)	Bulb type		
Front	Headlamps (Low/High)		60	HB3 HL+	
	Headlamps (Low/High) - LED type*		LED	LED	
	Front turn signal lamps	Bulb type	21	PY21W	
		LED type *	LED	LED	
	Front position lamps		LED type	LED	
	Daytime running light		LED type *	LED	
	Front fog lamps		Bulb type	51	HB4
	Side Repeater lamps		LED type *	LED	LED
Rear	Rear Stop/Tail lamps (outside)	Bulb type	21/5	P21/5W	
	Rear tail lamps (Inside)		3.8	W3.8W	
	Rear fog lamps (Inside)		LED type *	LED	LED
	Rear Stop/Tail lamps (outside)	LED type	LED	LED	
	Rear tail lamps (Inside)		LED	LED	
	Rear turn signal lamps	Bulb type	28/8	P28/8W	
		LED type	27	P27W	
	Back-up lamps		16	W16W	
	High mounted stop lamp		LED	LED	
	License plate lamps		5	W5W	
Interior	Map lamps	Bulb type	10	WEDGE	
		LED type	LED	LED	
	Room lamps	Bulb type	10	FESTOON	
		LED type	LED	LED	
	Vanity mirror lamps		5	FESTOON	
	Liftgate lamp	Bulb type	10	FESTOON	
LED type		LED	LED		

* If equipped

Tires and wheels

Item	Tire size	Wheel size	Load Capacity		Speed capacity		Inflation pressure [bar (psi, kPa)]				Wheel lug nut torque [lbf·ft (kgf·m, N·m)]
			LJ ^{*2}	kg	SS ^{*3}	km/h	Normal load ^{*1}		Maximum load		
							Front	Rear	Front	Rear	
Full size tire	215/55 R17	7JX 17	94	670	V	240	2.5 (36,250)	2.5 (36,250)	2.5 (36, 250)	2.5 (36, 250)	79-94 (11~13, 107~127)

*1.Normal load: Up to 3 persons

*2.Load Index

*3.Speed Symbol

⚠ CAUTION

When replacing tires, use the same size originally supplied with the vehicle.

Using tires of a different size can damage the related parts or make them work irregularly.

* NOTICE

- It is permissible to add 3 psi to the standard tire pressure specification if colder temperatures are expected soon.
Tires typically lose 1 psi for every 12 °F temperature drop. If extreme temperature variations are expected, recheck your tire pressure as necessary to keep them properly inflated.
- We recommend that when replacing tires, use the same originally supplied with the vehicles. If not, that affects driving performance.
- When driving in high altitude grades, it is natural for the atmospheric pressure to decrease. Therefore, please check the tire pressure and add more air when necessary.
Additionally required tire air pressure per km above sea level: 1.5 psi (10.5 kPa)/km

Volume and weight

Gross Vehicle Weight	Luggage Volume	
4,916 lbs. (2,230 kg)	Min.	Max.
	22.2 cu ft (629 l)	63.7 cu ft (1,804 l)

Air conditioning system

Items		Weight of Volume (g)	Classification
Refrigerant	Without heat pump	650±25	R-1234yf
	With heat pump	1,000±25	
Compressor lubricant	Without heat pump	130±10	RB100
	With heat pump	180±10	

Have your vehicle inspected by an authorized Kia dealer.

Recommended lubricants and capacities

To help achieve proper vehicle performance and durability, use only lubricants of the proper quality.

These lubricants and fluids are recommended for use in your vehicle.

Lubricant		Volume	Classification
Reduction gear fluid		1.0~1.1 US qt. (1.0~1.1 l)	70 W, API GL-4, TGO-9 (MS517-14)
Coolant	Without heat pump	13.2~13.7 US qt. (12.5~13 l)	Mixture of antifreeze and water (Phosphate-based Ethylene glycol coolant for aluminum radiator)
	With heat pump	13.7~14.2 US qt. (13~13.4 l)	
Brake fluid		Required amount	FMVSS116 DOT-3 or DOT-4

Vehicle identification number (VIN)

The vehicle identification number (VIN) is the number used in registering your vehicle and in all legal matters pertaining to its ownership, etc.

The number is punched on the floor under the passenger seat. To check the number, open the cover.

Frame number



ODEEV108001NR

The VIN is also on a plate attached to the top of the dashboard. The number on the plate can easily be seen through the windshield from outside.

VIN label



ODEEV108002NR

Vehicle certification label

The vehicle certification label attached on the driver's side center pillar gives the vehicle identification number (VIN).



ODEEV108006NR

Tire specification and pressure label

The tire label located on the driver's side center pillar gives the tire pressures recommended for your vehicle.



ODEEV098028NR

The tires supplied on your new vehicle are chosen to provide the best performance for normal driving.

Motor number

The motor number is stamped on the motor block as shown in the drawing. The motor number can be seen from under the vehicle.



ODEEV108003NR

Air conditioner compressor label

A compressor label informs you the type of compressor your vehicle is equipped with such as model, supplier part number, production number, refrigerant (1) and refrigerant oil (2).



ODEEV108004NR

Refrigerant label

The refrigerant label is located on the underside of the hood.



ODEEV108005NR

Consumer Assistance (U.S. only)

Roadside Assistance is provided on all new current model year Kia Vehicles from the date the vehicle is delivered to the first retail buyer or otherwise put into use (in-service date), whichever is earlier, for a period of 60 months or 60,000 miles, whichever is earlier, subject to the terms, conditions and exclusions set forth in the Kia Warranty and Consumer Information Manual applicable to your model year vehicle.

KMA reserves the right to limit or deny services or other benefits to any owner or driver when, in KMA's judgment, the claims and/or service requests are excessive in frequency or type of occurrence.

Toll free consumer assistance

from 5:00 AM to 6:00 PM PST, Monday through Friday and is accessible by dialing 1-800-333-4Kia (4542).

For more information regarding assistance available, please refer to your Kia Warranty & Consumer Information Manual.

Emergency roadside assistance

hours a day, 365 days a year and is accessible by dialing 1-800-333-4Kia (4542).

Please note that you must provide your Vehicle Identification Number (VIN) to verify coverage at the time of your call. The VIN can be found on the dash of your vehicle on the driver's side, on the door jamb of the driver's door, your vehicle's registration or proof of insurance card.

Kia utilizes a network of over 30,000 roadside assistance providers.

Should you accidentally run out of fuel, require a battery jump, or need help changing a tire, a Kia Roadside Assistance Representative will dispatch someone to deliver a small quantity of gas, change a flat tire with your inflated spare, or arrange a battery jump to allow you to proceed to your destination. We have access to a network of over 10,000 locksmiths to help you should you become locked out of your Kia.

In the event that mechanical difficulty renders your vehicle undrivable due to a warranty-related concern, Kia's Roadside Assistance Representative will arrange to transport your vehicle to the nearest Kia dealer or to an authorized Kia alternative service location.

Your vehicle must be accessible to our dispatch transport vehicle, as determined by our driver, to receive this service.

* NOTICE

Roadside Assistance benefits are not available for any Kia vehicle that has ever been or should be issued a "salvage" title or similar "branded" title under any state's law or has been declared a "total loss" or equivalent by a financial institution or insurance company.

Trip interruption

Trip interruption expense benefits are provided in the event that a warranty-related disablement occurs more than 150 miles from your home, and the repairs require more than 24 hours to complete. Reasonable reimbursement is included for meals, lodging, or rental vehicle expenses. Trip interruption coverage is limited to \$100 per day subject to a three day maximum limit per incident. You must contact the Kia Roadside Assistance Center to obtain pre-authorization of expenses. Once the Kia Roadside Assistance Center gives authorization for trip interruption benefits, they will assist you in making the necessary arrangements. Insurance deductibles, expenses, and claims paid by your insurance company or other providers are not eligible for reimbursement.

Fleet vehicles are excluded from reimbursement under Kia's Trip Interruption Policy.

Registering your vehicle in a foreign country

If you plan to register your vehicle in a foreign country, you should confirm that it conforms to the regulations in that country. Even if you successfully register the vehicle in a foreign country, you may experience the following problems and should therefore consider the possibility of having to deal with them:

1. The fuel specified for your vehicle may be unavailable. If other than the specified fuel is used, it could cause damage to the engine, the fuel injection system, and other fuel-related parts which may not be covered under your New Vehicle Emissions Limited Warranty.
2. We must, therefore, clearly state that when you leave the country in which you purchased your Kia new and register it in another country, problems arising from the use of fuel other than the specified fuel are not subject to manufacturer's warranty. Because vehicles like yours may not be marketed in the new country of registration, parts, servicing techniques and tools necessary to maintain and repair your vehicle may be unavailable.

Even if vehicles like yours are sold there, mechanical specifications required by the government may vary enough from the country of purchase to cause additional problems.

3. There may not be an Authorized Kia Dealer in the area in which you plan to register your vehicle. You may additionally experience difficulty in obtaining services in a foreign country for any number of reasons.

Further, we cannot assume any responsibility for problems that result from unsatisfactory service or lack of service outside of the United States.

Electrical Equipment (U.S. only)

The electrical system of your vehicle is designed to perform under all reasonably expected operating conditions.

However, before any additional electrical equipment is installed in your vehicle, consult an Authorized Kia Dealer, in order to ensure that you do not void your warranty.

Certain electrical equipment, or the way in which it is installed, may adversely affect the operation of your vehicle, including such systems as the engine control system, the audio system and the electrical charging system and thus potentially void all or part of your warranty.

We assume no responsibility for any expense you may incur or for any malfunction of your vehicle or any of its components or systems that may result from the installation of additional electrical equipment that is not supplied, or recommended for installation by, Kia.

Installation of a mobile two-way radio system

If a mobile two-way radio system is installed improperly, or if an excessively powerful type of system is used, other electronic systems may be adversely affected. To avoid damage to your vehicle, consult an Authorized Kia Dealer concerning the proper equipment and installation.

Kia motor vehicles are designed and manufactured to meet or exceed all applicable safety standards.

For your safety, however, we strongly urge you to read and follow all directions in this Owner's Manual, particularly the information under the headings "NOTICE", "CAUTION" and "WARNING".

If, after reading this manual, you have any questions regarding the operation of your vehicle, safety issues and defects please contact your Kia's toll-free Consumer Assistance hot line as below:

National Consumer Affairs Manager
Kia Motors America, Inc.
P.O. Box 52410
Irvine, CA 92619-2410
1-800-333-4Kia (4542)

Reporting Safety Defects (U.S. only)

If you believe that your vehicle has a defect which could cause a crash or could cause injury or death, you should immediately inform the National Highway Traffic Safety Administration (NHTSA) in addition to notifying Kia Motors America, Inc.

If NHTSA receives similar complaints, it may open an investigation, and if it finds that a safety defect exists in a group of vehicles, it may order a recall and remedy campaign. However, NHTSA cannot become involved in individual problems between you, your dealer, or Kia Motors America, Inc.

To contact NHTSA, you may call the Vehicle Safety Hotline toll-free at 1-888-327-4236 (TTY: 1-800-424-9153); go to <http://www.safercar.gov>; download the SaferCar mobile application; or write to: Administrator, NHTSA, 1200 New Jersey Ave. SE., Washington, DC 20590. You can also obtain other information about motor vehicle safety from <http://www.safercar.gov>.

Online factory authorized manuals (U.S. only)

The following publications are available on www.KiaTechinfo.com.

Service manual

This manual covers maintenance and recommended procedures for repair to engine and chassis components. It is written for the Journeyman mechanic, but is simple enough for most mechanically inclined owners to understand.

Electrical troubleshooting manual

This manual complements the Service Manual by providing indepth troubleshooting information for each electrical circuit in your vehicle.

Owner's manual

This manual describes the overall features and operating procedures for the vehicle.

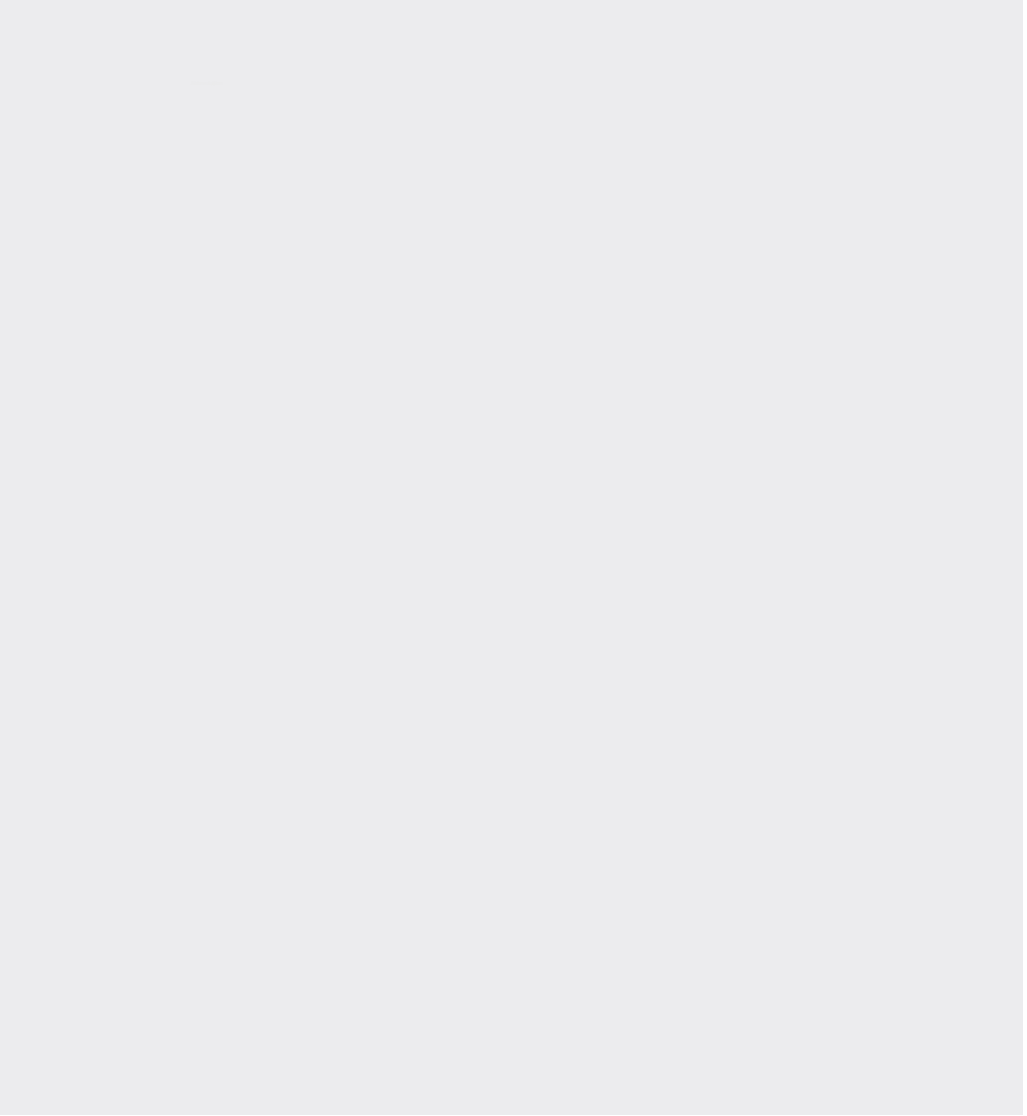

ABBREVIATION

ABS

Anti-lock Brake System

BCM

Body Control Module

BCW

Blind-spot Collision Warning

CRS

Child Restraint System

DAW

Driver Attention Warning

DRL

Day time Running Light

EBD

Electronic Brake force Distribution

ECM

Electric Chromic Mirror

EDR

Event Data Recorder

EFD

Emergency fastening device

EPB

Electronic Parking Brake

EPS

Electronic Power Steering

ESC

Electronic Stability Control

EV

Electric Vehicle

FCA

Forward Collision-avoidance Assist

FCC

Federal Communications Commission

FMVSS

Federal Motor Vehicle Safety Standards

HAC

Hill-start Assist Control

HBA

High Beam Assist

HMSL

High Mounted Stop Lamp

HV

High Voltage

ICCB

In-Cable Control Box

LATCH

Lower Anchors and Tether for Children

LDC

Low voltage DC-DC Converter

LFA

Lane Following Assist

LKA

Lane Keeping Assist

Abbreviation

NHTSA

National Highway Traffic Safety Administration

MIL

Malfunction Indicator Lamp

MMT

Methylcyclopentadienyl Manganese Tricarbonyl

OBC

On-board Battery Chargers

ODS

Occupant Detection System

RCCA

Rear Cross-traffic Collision-avoidance Assist

RCCW

Rear Cross-traffic Collision Warning

SCC

Smart Cruise Control

SOC

State Of Charge

SRS

Supplemental Restraint System

SRSCM

SRS Control Module

TBT

Turn By Turn

TIN

Tire Identification Number

TMK

Tire Mobility Kit

TPMS

Tire Pressure Monitoring System

VCU

Vehicle Control Unit

VESS

Virtual Engine Sound System

VIN

Vehicle Identification Number

VSM

Vehicle Stability Management

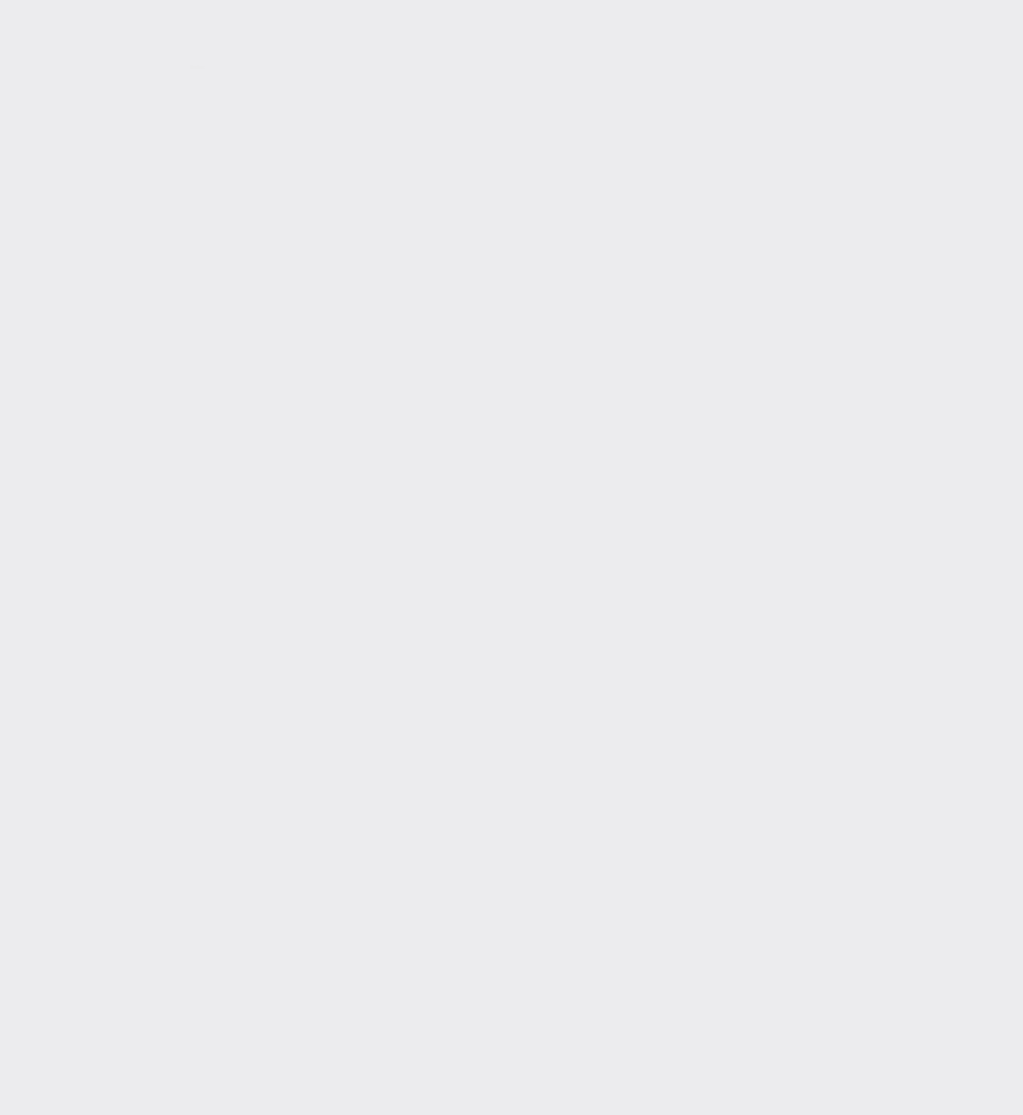

INDEX

Numerics

12 V Aux. Battery Saver+ 1-52

A

AC charge 1-13, 1-22
charging indicator 1-26
connecting AC charger 1-22
disconnecting AC charger 1-27
disconnecting charging connector
in emergency 1-28
storing and keeping AC charging
cable 1-28
air bag warning label 4-65
air bag warning light 4-45
air bags 4-42
air bag warning label 4-65
air bag warning light 4-45
curtain air bag 4-59
driver's and passenger's front air
bag 4-55
inflation conditions 4-62
non-inflation conditions 4-63
occupant detection system 4-48
operation 4-43
side air bag 4-58
SRS care 4-64
SRS components and functions 4-46
**air conditioner compressor
label** 9-8
air conditioning system 9-5
air ventilation seat 5-125
anti-lock brake system (ABS) 6-37
appearance care 8-67
exterior care 8-67
interior care 8-72
armed stage 5-11
armrest (rear) 4-16
assist mode 5-55
audio system 5-136

antenna 5-136
USB port 5-137
auto defogging system 5-120
auto hold 6-33
auto light 5-93
**automatic climate control
system** 5-106
air conditioning 5-111
air conditioning for driver only 5-113
air conditioning refrigerant label 5-117
automatic ventilation 5-113
checking the amount of air
conditioner refrigerant and
compressor lubricant 5-116
climate control air filter 5-116
controlling air intake 5-110
controlling fan speed 5-111
displaying climate information 5-113
heating and air conditioning
automatically 5-107
manual heating and air
conditioning 5-108
mode selection 5-109
system operation 5-114
temperature control 5-110
turning heater on or off 5-112
turning off the front air climate
control 5-113
windshield defrosting and
defogging 5-117

B

battery 8-23
for best battery service 8-23
recharging the battery 8-24
reset items 8-25
battery information 1-3
battery saver function 5-91
before driving 6-5
**blind-spot collision warning
(BCW)** 6-78
BCW alert 6-81
detecting sensor (radar) 6-82

limitations	6-84	AC charge	1-13
operating conditions	6-80	DC charge	1-13
setting and activating	6-79	trickle charge	1-14
setting the warning volume of the blind-spot collision warning	6-80	charging indicator	1-16
warning message	6-83	checking tire inflation pressure	8-26
bonnet, see the hood	5-24	child restraint system	4-32
brake fluid	8-17	securing a child restraint seat with tether anchor	4-38
checking the brake fluid level	8-17	securing a child restraint with a lap/shoulder belt	4-39
brake system	6-27	securing a child restraint with the LATCH anchors	4-37
anti-lock brake system (ABS)	6-37	child-protector rear door lock	5-17
auto hold	6-33	climate control air filter	8-19
electronic parking brake	6-28	filter inspection	8-19
electronic stability control (ESC)	6-39	replacing filter	8-19
hill-start assist control (HAC)	6-44	coat hook	5-132
power brakes	6-27	combined instrument, see instrument cluster	5-46
vehicle stability management (VSM)	6-42	consumer assistance	9-9
bulb replacement precaution	8-54	coolant	8-14
bulb wattage	9-3	changing the coolant	8-16

C

California perchlorate notice	8-75
camera (rear view)	5-90
capacities (lubricants)	9-5
care	
care of seat belts	4-31
exterior care	8-67
interior care	8-72
SRS care	4-64
tire care	8-25
care of seat belts	4-31
cargo security screen	5-134
center console storage	5-121
central door lock switch	5-15
certification label	6-125
chains - tire	6-119
characteristics of electric vehicles	1-3
charging connector lock	1-17
charging time information	1-15
charging types	1-13

changing the coolant	8-16
checking the coolant level	8-15
recommended coolant	8-14
cooling fluid, see coolant	8-14
cup holder	5-123
curtain air bag	4-59

D

dashboard illumination, see instrument cluster control	5-47
dashboard, see instrument cluster	5-46
day/night rearview mirror	5-35
daytime running light	5-91
DC charge	1-13, 1-30
connecting DC charger	1-30
disconnecting DC charger	1-32
defogging (windshield)	5-117
defroster (rear window)	5-105

defrosting (windshield)	5-117	distance to empty	1-45
dimensions	9-2	power/charge gauge	1-46
disarmed stage	5-12	starting	1-43
displays, see instrument cluster		state of charge (SOC) gauge for high voltage battery	1-47
distance to empty	1-45, 5-49	stopping	1-44
door locks	5-13	utility mode	1-54
central door lock switch	5-15	virtual engine sound system	1-44
child-protector rear door lock	5-17	warning and indicator lights	1-54
from inside the vehicle	5-15	warning message on LCD	1-48
from outside the vehicle	5-13	driving in flooded areas	6-117
drinks holders, see cup holders		driving in the rain	6-116
drive mode	5-123	driving info display	5-65
drive mode integrated control system	6-76	driving off-road	6-117
drive mode	6-76		
initial setting	6-77		
driver attention warning (DAW)	6-96		
DAW disabled	6-99		
displaying the driver's attention level	6-97		
malfunction	6-99		
resetting	6-98		
setting and activating	6-96		
taking a break	6-98		
driver position memory system	4-10		
easy access function	4-11		
recalling positions from memory	4-11		
storing driver's seat positions	4-11		
driver's 3-point system with emergency locking retractor	4-22		
driver's and passenger's front air bag	4-55		
driver's seat belt			
adjusting height	4-23		
fastening seat belt	4-22		
driving at night	6-116		
driving electric vehicle	1-43		
12 V Aux. Battery Saver+	1-52		

E

electric vehicle specifications	9-2
electrical equipment	9-11
electrochromic mirror (ECM)	5-36
electronic parking brake	6-28
electronic power steering	5-31
electronic stability control (ESC)	6-39
emergency starting	7-5
jump starting	7-5
emergency while driving	7-4
EV menu	1-7
available range	1-7
battery information	1-8
charge management	1-9
charging current	1-11
charging location	1-10
climate control settings	1-10
ECO driving	1-11
ECO driving history	1-12
energy information	1-8
environment contribution	1-11
EV setting	1-12
off-peak time settings	1-10
power consumption	1-8
reserved charging and climate control	1-9

setting battery charge level	1-11	folding the rear seat	4-16
setting departure time	1-9	forward collision-avoidance assist (FCA) (SCC equipped)	6-45
warning	1-13	brake operation	6-48
winter mode	1-12	front radar/camera sensor	6-49
explanation of scheduled maintenance items	8-12	limitations	6-53
air conditioning refrigerant	8-13	malfunction	6-51
brake discs, pads, calipers and rotors	8-13	prerequisite for activation	6-47
brake fluid	8-13	recognizing pedestrians	6-57
brake hoses and lines	8-12	setting and activation	6-46
coolant	8-12	setting initial warning activation time	6-46
cooling system	8-12	warning message and brake control	6-47
drive shafts and boots	8-13	warning message and warning light	6-50
steering gear box, linkage and boots/lower arm ball joint	8-13	front passenger and rear seat belt	
suspension mounting bolts	8-13	fastening seat belt	4-24
exterior care	8-67	releasing seat belt	4-26
exterior features	5-135	front seat adjustment for manual seat	4-8
roof rack	5-135	forward and backward	4-8
exterior overview	3-2	seat height	4-9
		seatback angle	4-9

F

FCC	5-140	front seat adjustment for power seat	4-9
flat tire (with tire mobility kit)	7-16	forward and backward	4-10
checking the tire inflation pressure	7-22	lumbar support for driver's seat	4-10
components of the tire mobility kit	7-19	seat height	4-10
distributing the sealant	7-22	seatback angle	4-10
introduction	7-17	fuses	8-39
notes on the safe use of the tire mobility kit	7-17	fuse/relay panel description	8-44
technical data	7-24	replacing inner panel fuse	8-41
using the tire mobility kit	7-20	replacing motor compartment fuse	8-42
floor mat anchor(s)	5-132		
fluid			
brake fluid	8-17	G	
washer fluid	8-18	gauges	5-48
fog light (front)	5-94	glove box	5-121
folding the outside rearview mirror	5-43		

H

hazard warning flasher	7-3
-------------------------------	-----

headlight (headlamp) escort function	5-91	seat warmer	5-124
headlight position	5-92	sun visor	5-126
headrest (front)	4-12	USB charger	5-128
adjusting the height up and down	4-12	wireless smart phone charging system	5-128
reinstalling the headrest	4-14	interior light	5-101
removing the headrest	4-13	automatic turn off function	5-101
headrest (rear)	4-15	liftgate room lamp	5-103
adjusting the height up and down	4-15	map lamp	5-102
removal and reinstallation	4-15	room lamp	5-101
heated steering wheel	5-33	vanity mirror lamp	5-103
heating and air conditioning automatically	5-107	interior overview	3-5
high beam assist	5-95		
highway driving	6-117	J	
hill-start assist control (HAC)	6-44	jump starting	7-5
hood	5-24		
closing the hood	5-25	L	
hood open warning	5-25	label	
opening the hood	5-24	air conditioner compressor label	9-8
horn	5-34	refrigerant label	9-8
		tire sidewall labeling	8-29
		tire specification and pressure label	9-7
		vehicle certification label	9-6
if an accident occurs	7-29	lane following assist (LFA)	6-101
immobilizer system	5-10	activating	6-102
indicator lights	5-78	cautions for driver	6-104
inside rearview mirror	5-35	limitations	6-104
instrument cluster	5-46	malfunction	6-103
gauges	5-48	steering assist	6-102
indicator lights	5-78	warning message	6-103
LCD window control	5-47	lane keeping assist (LKA)	6-106
warning lights	5-73	activation	6-108
instrument panel overview	3-7	driver's attention	6-111
interior care	8-72	function change	6-113
interior features	5-123	malfunction	6-113
air ventilation seat	5-125	operation	6-108
cargo security screen	5-134	warning message	6-109
coat hook	5-132	LCD display	5-53
cup holder	5-123	assist mode	5-55
floor mat anchor(s)	5-132	LCD display control	5-53
luggage net holder	5-133	LCD display modes	5-54
power outlet	5-127		

day/night rearview mirror	5-35
electrochromic mirror (ECM)	5-36
folding the outside rearview mirror	5-43
inside rearview mirror	5-35
outside rearview mirror	5-42
motor number	9-7
motor room compartment	3-9, 8-4

O

occupant detection system	4-48
odometer	5-50
online factory authorized manuals	9-13
operating high beam	5-93
outside rearview mirror	5-42
outside temperature gauge	5-50
overheats	7-8
overview of electric vehicle	1-3
owner maintenance	8-7

P

parking	6-12
parking distance warning	5-85
non-operational conditions of parking distance warning	5-88
operation of the parking distance warning	5-86
self-diagnosis	5-89
parking distance warning-reverse	5-81
non-operational conditions of parking distance warning-reverse	5-82
operation of the parking distance warning-reverse	5-82
self-diagnosis	5-84
parking tail light	5-92
power brakes	6-27
power button	6-6
power button position	6-6
starting the vehicle	6-8

turning off the vehicle	6-9
power button position	6-6
power outlet	5-127
power window lock button	5-23
power/charge gauge	1-46, 5-48
precautions for charging	1-19
pre-tensioner seat belt	4-27

R

reduction gear	
parking	6-12
rear cross-traffic collision warning (RCCW)	6-88
detecting sensor	6-90
limitations	6-92
operating conditions	6-89
RCCW alert	6-89
setting and activating	6-88
warning message	6-91
rear view monitor	5-90
recommended lubricants and capacities	9-5
record your key number	5-6
reduction gear	5-51, 6-10
good driving practices	6-15
LCD display messages	6-12
operation	6-10
reduction gear operation	6-10
refrigerant label	9-8
regenerative braking level indicator	5-51
replacing back-up lamp bulb	8-62
replacing fog lamp/DRL/position lamp bulb	8-59
replacing front turn signal lamp bulb	8-59
replacing headlamp (high/low beam) bulb	8-58
replacing headlamp (LED type)	8-57
replacing high mounted stop lamp bulb	8-62

replacing license plate lamp bulb	8-62	scheduled maintenance service	8-9
replacing liftgate room lamp bulb	8-66	maintenance under severe usage conditions	8-11
replacing map lamp (bulb type) bulb	8-63	normal maintenance schedule	8-10
replacing map lamp (LED type) bulb	8-64	seat belt precautions	4-29
replacing room lamp (bulb type) bulb	8-65	seat belt restraint system	4-19
replacing room lamp (LED type) bulb	8-65	seat belts	4-19
replacing side repeater lamp (LED type) bulb	8-63	care of seat belts	4-31
replacing smart key battery	5-9	driver's 3-point system with emergency locking retractor	4-22
replacing stop and tail lamp (LED type) bulb	8-61	pre-tensioner seat belt	4-27
replacing stop and tail lamp (rear bulb type) bulb	8-60	seat belt precautions	4-29
replacing tail lamp (inside) bulb	8-61	seat belt restraint system	4-19
replacing vanity mirror lamp bulb	8-64	seat warmer	5-124
reporting safety defects	9-12	seatback pocket (front)	4-14
reserved charging	1-18	seats	4-5
resetting the sunroof	5-30	armrest (rear)	4-16
road warning	7-3	driver position memory system	4-10
rocking the vehicle	6-115	folding the rear seat	4-16
roof rack	5-135	front seat adjustment for manual seat	4-8
room lamp	5-101	front seat adjustment for power seat	4-9
rotation (tire)	8-27	headrest (front)	4-12
		headrest (rear)	4-15
		important safety precautions	4-3
		seatback pocket (front)	4-14
		securing a child restraint seat with tether anchor	4-38
		securing a child restraint with a lap/shoulder belt	4-39
		securing a child restraint with the LATCH anchors	4-37
		service interlock connector	1-58
		service plug	1-58
		shift indicator pop-up	5-51
		sliding the sunroof	5-28
		smart cruise control system	6-59
		accelerating temporarily with smart cruise control on	6-62
		adjusting the sensitivity	6-70
		converting to cruise control mode	6-71

S

safety precautions for electric vehicle	1-56
if an accident occurs	1-56
other precautions for electric vehicle	1-57
service interlock connector	1-58
service plug	1-58

tire pressure monitoring system (TPMS)	7-9	disconnecting portable charging cable	1-40
effective use of TPMS	7-10	precautions for portable charging cable	1-42
low tire pressure position telltale	7-12	setting charging current	1-33
malfunction indicator	7-13	trip computer mode	5-55
tire pressure indicator	7-10	trip information (trip computer)	5-62
tire replacement with TPMS	7-14	turn by turn (TBT) mode	5-55
tire replacement	8-28	turn signals	5-94
tire rotation	8-27	turning off the vehicle	6-9
tire specification and pressure label	9-7		
tires and wheels	8-25		
all season tires	8-36	U	
checking tire inflation pressure	8-26	USB charger	5-128
low aspect ratio tire	8-38	user settings mode	5-56
radial-ply tires	8-37	utility mode	1-54, 5-52
recommended cold tire inflation pressures	8-25		
snow tires	8-36	V	
summer tires	8-36	vanity mirror lamp	5-103
tire care	8-25	vehicle certification label	9-6
tire chains	8-37	vehicle data collection and event data recorders	2-2
tire maintenance	8-29	vehicle identification number (VIN)	9-6
tire pressure	8-26	vehicle load limit	6-123
tire replacement	8-28	certification label	6-125
tire rotation	8-27	tire and loading information label	6-123
tire sidewall labeling	8-29	vehicle overheats	7-8
tire terminology and definitions	8-33	vehicle stability management (VSM)	6-42
tire traction	8-29	vehicle weight	6-127
wheel alignment and tire balance	8-28	vehicle will not start	7-5
wheel replacement	8-29	virtual engine sound system	1-44
towing	7-24	volume and weight	9-5
emergency towing	7-26		
removable towing hook	7-26	W	
towing service	7-24	warning and indicator lights	5-73
without wheel dollies	7-25	warning lights	5-73
trickle charge	1-14, 1-33	washer fluid	8-18
actions to be taken on charging issues	1-43		
charging	1-35		
charging status indicator	1-38		
disconnecting charging connector in emergency	1-41		

checking the washer fluid level	8-18
welcome system	5-104
wheel alignment and tire balance	8-28
wheel replacement	8-29
windows	5-20
power window lock button	5-23
windshield defrosting and defogging	5-117
windshield washers	5-98
windshield wipers	5-98
winter driving	6-118
snow tires	6-119
snowy or icy conditions	6-118
tire chains	6-119
wiper blades	8-20
blade inspection	8-20
replacing blade	8-21
replacing rear window wiper blade	8-22
wipers and washers	5-98
rear window wiper and washer	5-100
windshield washers	5-98
wireless smart phone charging system	5-128



Scan the QR code with your smartphone and download the KIA AR Owner's Manual Application.

2019 KIA MOTORS AMERICA. INC.



The Power to Surprise