



ASTON MARTIN

DB11

Welcome

Welcome to your new Aston Martin DB11.

This Owner's Handbook has been designed to explain the vehicle's operation and to make the control of its systems easy to understand and operate. All new owners are recommended to read the Owner's Handbook prior to driving. This Owner's Handbook forms part of the essential vehicle equipment for homologation purposes and must stay with the vehicle at all times.

Warnings, Cautions and Notes

The following Warnings, Cautions and Notes are used within this Owner's Guide to call your attention to specific types of information.

⚠ Warning: *Provided to show procedures which must be followed precisely to help avoid the risk of personal injury.*

⚠ Caution: *Provided to show procedures which must be followed precisely to reduce the possibility of damage to your vehicle.*

📖 Note: *Provided to show procedures which will help to avoid difficulties in the operation of your vehicle.*

Airbag Warning Labels

⚠ Warning: Extreme Hazard: NEVER use a rearward facing child restraint on a seat protected by an ACTIVE AIRBAG in front of it. DEATH or SERIOUS INJURY to the Child can occur.

Warning labels are located on both sides of the passenger sun visor and on the passenger end of the instrument panel.



Vehicle Identification

Component Location

All directions for locating components are described as viewed from the driver's seat, i.e. the fuel filler flap shown on this diagram will be described as 'located at the rear right side of the vehicle'.

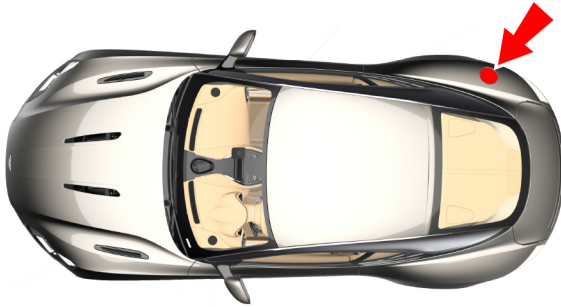

The Vehicle Identification Number (VIN) is shown in the left side bottom corner of the windscreen.

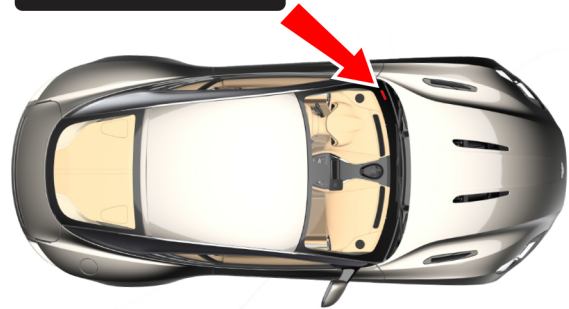

The VIN plate can also be found in the passenger side door shut panel and laser etched onto the right side footwell.

 To view the VIN etched into the floor panel, lift the carpet up from the front, and then lift the sound deadening material.

Data Recording

This vehicle is equipped with a Event Data Recorder (EDR) system. Electronic modules in this vehicle are able to record detailed data, such as:

- The use of restraint systems, including seat belts by the driver and passengers.
- Information about the performance of various systems and modules in the vehicle.
- Information related to engine, throttle, steering, brake or other system status.

Any of these systems can include information on how the driver operates the vehicle, measuring vehicle speed, steering input, brake and throttle application. This information may be stored under regular operation, in a crash or in a near crash event.

This information can be read and used by:

- Aston Martin
- Service and repair facilities
- Law enforcement or government agencies
- Others who may assert a right or obtain your consent to know such information.

To read data recorded by an EDR, special equipment is required, and access to the vehicle or the EDR is needed. In addition to the vehicle manufacturer, other parties, such as law enforcement, that have the special equipment, can read the information if they have access to the vehicle or the EDR.

Reporting Safety Defects

If you believe that your vehicle has a safety defect which could cause a crash or could cause injury or death, you should immediately inform your Aston Martin Dealer or the Aston Martin Client Services at the address shown.

Aston Martin Lagonda Limited

Client Services

Banbury Road

Gaydon

Warwick

CV35 0DB

England

Telephone:

+44 (0)1926 644700

Driving Safety

- Always wear your seat belt.
- Never drive under the influence of alcohol or drugs.
- Always obey all speed and traffic laws and regulations. Never drive faster than the posted speed limit or than conditions allow.
- Be particularly careful driving on slippery or wet surfaces.
- This vehicle is a high performance vehicle and has handling characteristics you may not be accustomed to. Familiarise yourself with the vehicle and always drive prudently, being aware of your own limitations and the limitations of the vehicle. As with other vehicles of this type, failure to operate the vehicle correctly can result in accident and injury.
- Follow the maintenance schedule approved in this guide.
- Never allow the vehicle to be driven by inexperienced drivers.

 *Make sure that you are wearing appropriate footwear to efficiently operate the control pedals. Make sure that pedal movement is not restricted by floor mats or other objects trapped beneath pedals.*



ASTON MARTIN

Aston Martin Owners' Club (AMOC)

An invitation to join the Aston Martin Owners' Club

The sporting spirit of the 1930s exists today in one of the world's most exclusive car clubs. Enthusiasts in nearly 60 countries are united by an interest in iconic cars with an enviable pedigree. Enjoy the company of like-minded owners in a wide range of activities: social evenings, weekends away or motoring tours. Something more competitive? AMOC Concours are a benchmark for connoisseurs of fine motorcars. A need for speed? We organise track days, sprints and hill climbs as well as circuit racing in venues such as Silverstone, Goodwood and Lime Rock in the USA.

Aston Martin Owners' Club
Drayton St. Leonard
Wallingford
Oxfordshire
England
OX10 7BG
+44 (0) 1865 400 400
E-Mail: hqstaff@amoc.org
Website: www.amoc.org



Aston Martin Heritage Trust

The Aston Martin Heritage Trust is an educational charity dedicated to the preservation, promotion and enhancement of over 100 years of history of Aston Martin. Its world class collection comprising the automotive museum, substantial archive and collection of historical artefacts is housed in the magnificently restored Grade II* listed barn in Oxfordshire which it shares with the Owners' Club. As a member of the Owners' Club you become a member and supporter of the Trust, so please log on to our web site for more information, or better still pay us a visit and see the collection for yourself.



Aston Martin Heritage Trust

Drayton St. Leonard

Wallingford

Oxfordshire

England

OX10 7BG

Telephone: +44 (0) 1865 400 414

E-Mail: secretary@amht.org.uk

Website: www.amht.org.uk



Quick Start.....	1
Vehicle Security	2
Before Driving.....	3
Controls	4
Driving.....	5
Climate Control.....	6
Phone System	7
Media Systems	8
Satellite Navigation	9
Vehicle Settings.....	10
Convertible Roof.....	11
Maintenance and Technical Data	12
Service	A
Aston Martin Warranty.....	B
Aston Martin Assistance.....	C
Alphabetical Index	D

Every effort has been made to make sure that the information provided in this Owner's Handbook is accurate and up-to-date. However, neither the manufacturer or the Dealer, by whom this Owner's Handbook is supplied, will in any circumstances be held responsible for any inaccuracy or the consequences thereof.

Software instructions in this handbook are correct at time of print.

However, these may be subject to change due to ongoing software updates during the vehicle's lifetime. Contact your Aston Martin Dealer for further information.

© Copyright Aston Martin Lagonda Limited, 2020. All Rights Reserved. This publication is provided with your vehicle for your personal, private and non-commercial use. No part of this publication may be reproduced, stored in a retrieval system or transmitted, in any form, electronic, mechanical, photocopying, recording or other means without prior written permission from Aston Martin Lagonda Limited.

The manufacturer reserves the right to vary specifications without notice in accordance with its policy of continual product improvement.

Produced by the Technical Publications Department
Aston Martin Lagonda Limited
Banbury Road
Gaydon
Warwick
CV35 0DB
England
Telephone:
+44 (0)1926 644300

Issue 1: April 2020
Part Number: MY53-19A321-AA
Barcodes conform to AML specification AMES000043



ASTON MARTIN

Quick Start

Vehicle Key	1.2
Driving Position	1.3
Vehicle Controls	1.6
Infotainment	1.11

Vehicle Key

What Do The Buttons On The Key Do?

(Refer to 'Vehicle Key', page 2.2)



[1] LOCK: Press to lock the vehicle and arm the security system.



[2] UNLOCK: Press to unlock either the driver's door or the vehicle.



[3] DECK LID OPEN: Press and hold to release the deck lid catch.



Global Close

Press and hold  to unlock all vehicle doors and open all windows.

Press and hold  to lock all doors and close all windows.

Volante: Global close will also open or close the convertible roof.

Keyless Entry

To unlock the vehicle, fully push the front edge of the door handle. If the system recognises a valid key signal, the door will unlock and open.

To lock the vehicle, close all the vehicle doors and press the rear edge of the door handle to activate the lock switch.

Driving Position

How Do I Adjust The Seat?

(Refer to 'Seat Adjustment', page 3.2)

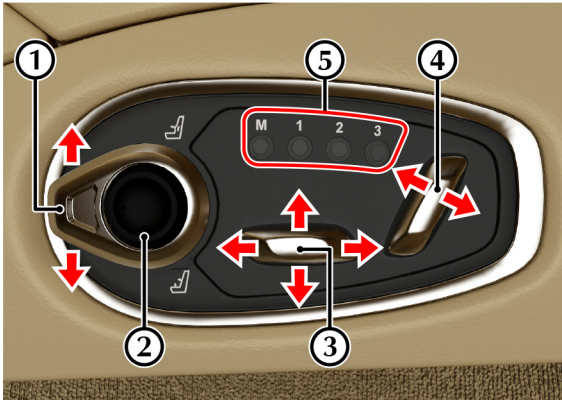

[1] BOLSTER/LUMBAR ADJUSTMENT SELECTOR SWITCH (OPTIONAL): Press the switch up to select lumbar adjustment. Press down to select bolster adjustment.

[2] BOLSTER/LUMBAR ADJUSTMENT: Use the directional pad to adjust the position of the lumbar or bolster support.

[3] SEAT POSITION ADJUST: Seat forward/backward and height adjust. Raise front to tilt base of seat.

[4] SEAT BACKREST ADJUST: Seat back angle adjust.

[5] MEMORY SEAT POSITIONS: Use to select or store memory positions for the seat, steering column and door mirror positions .

How Do I Get To The Back Seats?

Pull the release strap (A) to release the seat back. Pull and hold to move the rear of the seat forward.

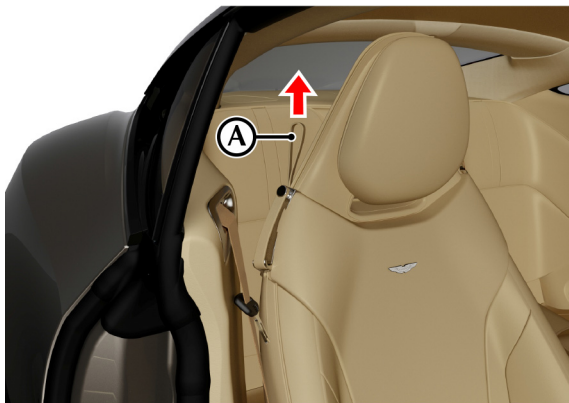

What Do The Door Switches Do?

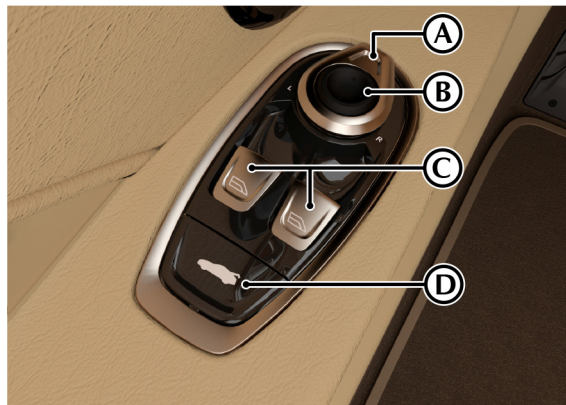

[A] DOOR MIRROR SELECTOR: Press to select left or right door mirror (Refer to 'Exterior Mirrors', page 3.7).

[B] DOOR MIRROR ADJUSTMENT: Use the direction pad to adjust the mirror position.

[C] WINDOW SWITCH: Press or pull to operate the driver or passenger windows (Refer to 'Windows', page 3.5).

[D] DECK LID: Press and hold to release the deck lid catch (Refer to 'Deck Lid', page 2.8).

How Do I Adjust The Steering Column?

(Refer to 'Steering Column', page 3.8)

The reach and tilt angle of the steering column are adjusted by using the adjustment lever. Push the lever down or up to adjust the steering column angle. Pull the lever towards you to bring the steering wheel closer and away to move the steering wheel back.



How Do I Use The Memory Positions?

(Refer to 'How Do I Use The Memory Positions?', page 1.5).

Setting a Position

Adjust the seat, steering column and the door rear view mirrors to the desired position. Push the memory button (M), then press the required memory channel (1, 2 or 3) to save the positions. A chime is heard and a message will show in the message centre to confirm. By repeating these steps and pressing an unused button, a second and third driving position can be saved in the memory.

Recalling a Memory Position

Once in the seat press and hold button 1, 2 or 3 (depending on which saved channel is required) until all movement is stopped. The seat will move to the saved position.

Seat and steering wheel movement will be interrupted if the memory channel button is released. Exterior mirror movement will continue. Press and hold the memory channel button to complete seat and steering wheel movement.

Vehicle Controls

What Do The Centre Stack Switches Do?

(Refer to 'Centre Stack Controls', page 4.5)

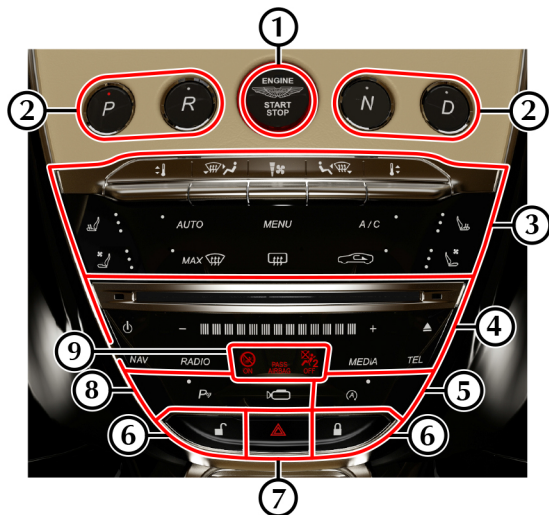

[1] ENGINE START/STOP:

Press to start or stop the engine (Refer to 'How To Start The Engine', page 5.4).

[2] TRANSMISSION CONTROL BUTTONS:

Press to select a transmission mode (Refer to 'Transmission Controls', page 5.5).

[3] HEATING AND COOLING CONTROLS:

Operates the climate controls (Refer to 'Centre Stack Climate Controls', page 6.2).

[4] INFOTAINMENT CONTROLS:

Operate the various infotainment controls.

(Refer to 'Multimedia Controls', page 8.4)

(Refer to 'Hands-Free Controls', page 7.2)

(Refer to 'Navigation Controls', page 9.3)

[5] STOP/START FUNCTION:

Turn the Stop/Start function on and off (Refer to 'Stop/Start', page 5.29).

[6] MASTER LOCK SWITCHES:

Lock or unlock the vehicle (Refer to 'Interior Lock Switches', page 2.7).

[7] HAZARD WARNING SWITCH:

Press to set the hazard warning lamps to ON or OFF (Refer to 'Hazard lamps', page 4.17).

[8] PARK ASSIST FUNCTIONS:

Operate PDC sensors or operate 360° camera system (Refer to 'Park Assist Systems', page 5.31).

[9] PASSENGER AIRBAG STATUS:

Indicator to show if the passenger airbag is active or not (Refer to 'Passenger Airbag Deactivation', page 3.20)

What Does The Control Dial Do?

Control Dial (shown with optional Touch Pad)

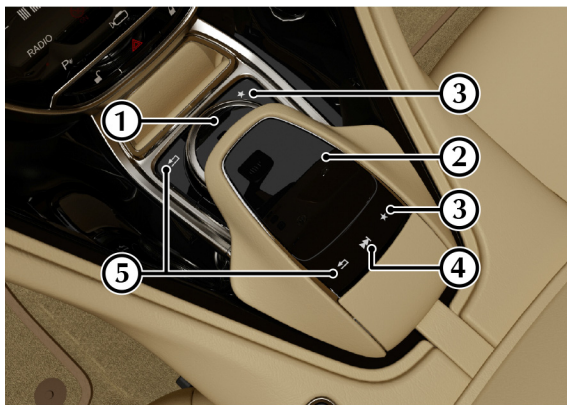

[1] CONTROL DIAL:

Use to navigate through menus in the infotainment system. Press down to confirm a selection (referred to as **ENTER** throughout this handbook).

[2] TOUCH PAD:

Touch sensitive pad which can be used to navigate menus in the infotainment system. Press down to confirm a selection. The touch pad can also be used for handwriting recognition (Refer to 'Touch Pad', page 4.7).

[3] FAVOURITE:

Press to view items on your favourites list. Press and hold to add the current menu item to the favourite list.



[4] QUICK ACCESS MENU:

Press to access the quick access menu.



[5] BACK:

Press to go back a level in the menu.



What Are The Steering Wheel Controls?

Switches

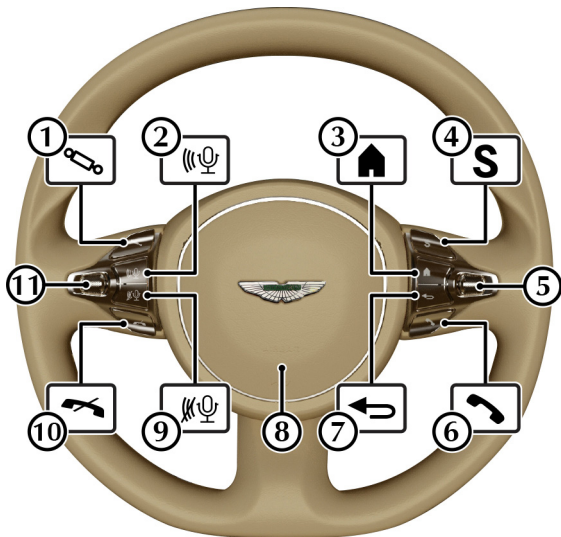

[1] ADAPTIVE DAMPING:

Press to cycle adaptive damping modes (Refer to 'Adaptive Damping', page 5.17).



[2] START VOICE CONTROL:

Press to start voice control (Refer to 'Voice Control', page 4.14).



[3] MENU HOME:

Press to open the instrument cluster menu (Refer to 'Instrument Cluster Menu', page 4.11).



[4] DRIVE MODE:

Press to cycle between drive modes (Refer to 'Drive Modes', page 5.11).



[5] MENU SCROLL:

Roll the menu scroll wheel up or down to navigate the instrument cluster menu. Press the scroll wheel button to select an item in the menu (referred to in this handbook as **OK**).

[6] CALL:

Press to answer an incoming call (Refer to 'Calls', page 7.5).

[7] MENU BACK:

Press to take the instrument cluster menu back one level.

[8] HORN:

Push to sound the vehicle horn.

[9] END VOICE CONTROL:

End voice control.

[10] END CALL:

Press to end a call or reject an incoming call.

[11] VOLUME DIAL:

Roll the volume scroll wheel up or down to increase or decrease volume for the audio system, or volume during a phone call.
Press the scroll wheel button to set sound to ON or OFF.



Transmission Paddles

Pull back on either paddle to enter *Touchtronic* mode (Refer to 'Touchtronic Mode', page 5.7).

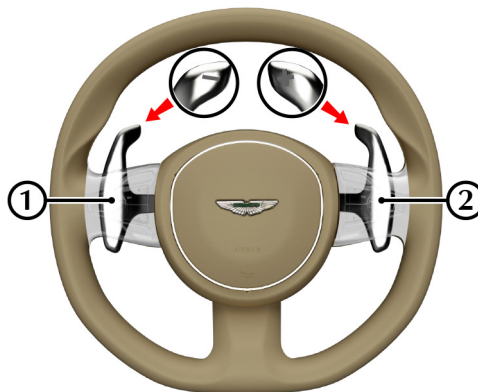

[1] : Downshift Paddle

[2] : Upshift Paddle

Neutral is selected by pulling back both paddles together and releasing or by pressing (N) Neutral on the centre stack.

P (Park) and R (Reverse) are selected with the PRND buttons.

What Do The Stalks Control?

Indicators and Headlamp Beam

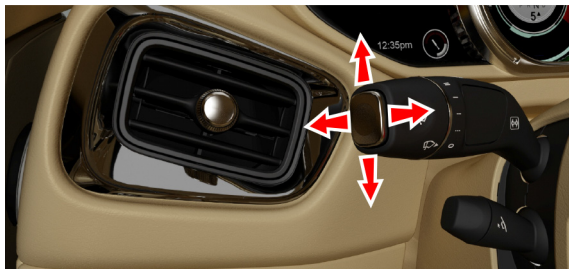

Main Beam

Push the stalk for main beam headlamps. Pull the stalk back to the initial position to return to dipped beam headlamps.

Flash Headlamps

Pull the stalk to flash the main beam headlamps.

Direction Indicators

Press up to briefly indicate a right turn and down for a left turn. Press until the switch latches to hold the selected indicator on.

Wiper Controls

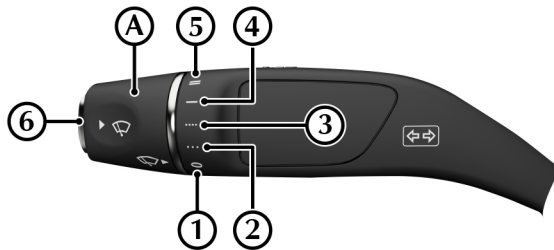

Rotate the wipe speed selector (A) to select a wipe speed.

[1] : Windscreen wipers OFF

[2] : Intermittent wipe (low rain sensor sensitivity)

[3] : Intermittent wipe (high rain sensor sensitivity)

[4] : Continuous wipe (slow)

[5] : Continuous wipe (fast)

[6] : Press for single wipe. Press and hold to operate the front windscreen washers.

How Do I Turn On The Exterior Lamps?

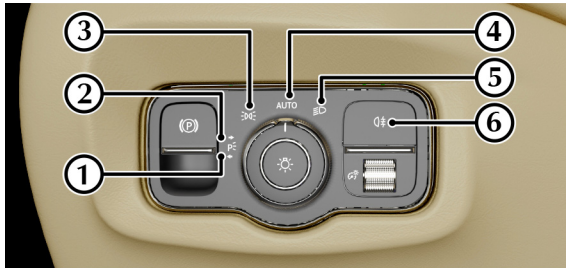

[1] : Left side park lamp

[2] : Right side park lamp

[3] : Side lamps (including number plate lamps)

[4] : Automatic headlamp mode

[5] : Dipped beam headlamps

[6] : Rear foglamp

How Do I Activate The Vehicle Bluetooth?

 Bluetooth® must be activate on both the vehicle and the mobile device to be used.

Before a Bluetooth®₁ device can be used with the vehicle Bluetooth®, the vehicle's Bluetooth® system must be set to ON.

To set the vehicle Bluetooth® system ON:

- Navigate to **Vehicle** on the main menu.
- Select **System Settings**.
- Select **Activate Bluetooth** and set to ON.

¹. The Bluetooth® word mark and logos are registered trademarks owned by Bluetooth SIG, Inc., and any use of such marks by Aston Martin is under license. Other trademarks and trade names are those of their respective owners.

How Do I Pair A Bluetooth Device

(Refer to 'Device Management', page 7.2)

To add a new device, select **Tel** from the main menu and navigate to **Connect Device** and select **Search for Phones** or **Search via Telephone**.

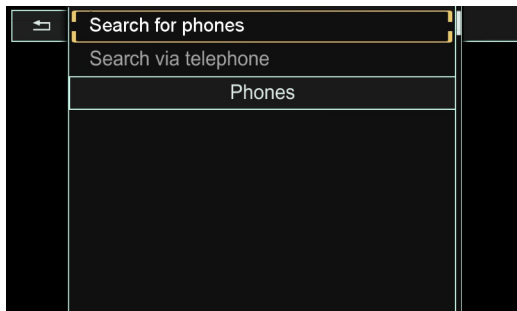

Search for Phones

 *The mobile device must be set to discoverable mode. Refer to the mobile device manufacturers instructions.*

Select **Search for Phones** to begin a search for discoverable phones. Select the required phone and press **ENTER**. Follow the instructions shown on the phone and the infotainment display to pair the phone.

Search via Telephone

Select **Search via Telephone** to set the infotainment system to 'listen' for a mobile phone connection. Follow the mobile phone manufacturer's instructions to search and connect to a new Bluetooth® device. The phone will search for discoverable Bluetooth® devices in its range.

Select *Aston Martin DB11* from the device list.

 *If Aston Martin DB11 does not show, check that Bluetooth is active in the infotainment system and search again.*

Follow the instructions shown on the phone and the infotainment display to pair the phone.

Completing Device Pairing

Once the mobile phone is paired it is ready for use with the vehicle hands-free system. The vehicle will also request access to call history, contact list and messages.

How Do I Operate The Media System?



[1] DISC SLOT:

Slot to insert a CD or DVD disc.

[2] EJECT:

Press to eject disc.



[3] MEDIA:

Opens the **Media** screen (Refer to 'Media', page 8.10).

Opens the media source list if media screen is already open.



[4] VOLUME CONTROLS:

Press to increase and to decrease volume. Sliding a finger along the volume bar will also increase or decrease volume.



 *Volume can also be controlled by the left scroll wheel on the steering wheel.*

[5] RADIO:

Open the **Radio** screen (Refer to 'Radio', page 8.5).

Opens the radio source list if media screen is already open.



[6] POWER:

Press to turn the infotainment system ON or OFF.



How Do I Pair A Bluetooth Audio Device

(Refer to 'Bluetooth Connection', page 8.16)

 *Bluetooth® audio must be paired to the vehicle independently from the Bluetooth® hands free connection.*

To select a Bluetooth® audio device:

1. Make sure Bluetooth® is activated on your device and in discoverable mode¹.
2. Select **Bluetooth Audio** as a media source.
3. In the **Options** menu, select **Bluetooth Audio Devices**.
4. Select a Bluetooth® device from the list of devices.

For new devices:

1. Select the device from the list to begin pairing.
2. A code will be shown on the infotainment display. If this code matches the code shown on the Bluetooth® device select **Yes** to complete pairing.
Select **No** to cancel pairing the Bluetooth® device.

How Do I Change The Media Source?

Press  or select **Media** from the main menu to show the available media sources. Rotate the **CONTROL DIAL** and press **ENTER** to select a media source.

Select from the following media sources:

- Disc
- Memory Card
- Media Register
- USB 1
- USB 2
- Bluetooth Audio

Alternatively, select a media source from *Devices*(Refer to 'Devices', page 8.15).

For formats that can be used (Refer to 'Media Formats and File Systems', page 8.11).

¹. Refer to device manufacturers instructions.

What Can I Listen To?

Radio

(Refer to 'Radio', page 8.5)

Press **RADIO** on the centre stack or select **Radio** from the main menu.

- FM/DAB Radio₁
- AM Radio₂
- Radio Presets

Rotate the **CONTROL DIAL** to select a radio source and press **ENTER**

Selecting a station from the display screen

The display screen shows available stations that can be played.

Rotate the **CONTROL DIAL** with the centre display highlighted to select a radio station.

Selecting a station from the current stations list

Press **ENTER** with the centre display highlighted to open the current stations list.

Rotate the **CONTROL DIAL** to select a radio station and press **ENTER**.

Portable Media Audio

Press **MEDIA** on the centre stack or select **Media** from the main menu to open the media *Now Playing* screen.

The *Now Playing* screen shows track information such as album art, artist and album name on the left side of the screen along with track play time and track number. Media source device and track name are shown on the right side of the screen.

1. DAB where available

2. MW frequencies only.

What Can I Watch?

Portable Media Video

Video files from portable media can also be supported with the infotainment system. In the *Now Playing* screen, highlight the view window area and press **ENTER**.

DVD Video Media

The *Now Playing* screen initially shows video in full screen mode. Press **ENTER** to bring up the basic DVD information bar which shows media source, track/title number, scene number and play time.

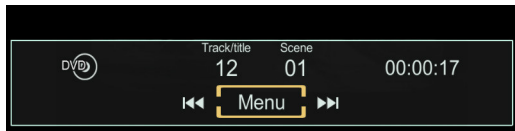

Press **ENTER** on **Menu** to show the upper and lower information bars. Media playback will continue.

To return to full screen display, push up or down on the **CONTROL DIAL** to highlight the display area and press **ENTER** on the full screen symbol .

How Do I Set A Navigation Destination?

(Refer to 'Destination', page 9.10)

Press  or select **Nav** to open the *Navigation* screen.

Select **Destination** from the lower information bar and select **Address Entry**.

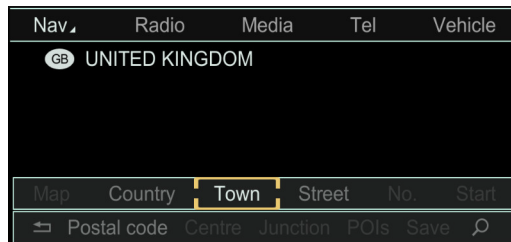

Enter a destination in the *Address Entry* screen and select **Start** to begin navigation.

Vehicle Security

Vehicle Key	2.2
Unlocking and Opening	2.5
Emergency Access and Start.....	2.11
Anti-Theft Systems.....	2.14
Aston Martin Tracking	2.15
Homelink® Wireless Control.....	2.19

Vehicle Key

The vehicle is supplied with three vehicle keys; Two primary keys and an emergency key.

Keep the second primary key in a safe place. Do not leave a vehicle key in the vehicle when unattended.

⚠ Warning: The engine can be started by any person in the vehicle if the brake pedal is pressed down and the start button is pressed. Care should be taken that the vehicle key is not left in the vehicle with only occupants such as young children or pets inside.

 If a vehicle key is lost, contact your Aston Martin Dealer.

 If the vehicle key is not in the vehicle, the message 'Key Not Found' will be displayed in the instrument cluster when trying to start the vehicle. This message will also be displayed if the vehicle key battery does not have enough charge to be detected by the keyless start system.

Radio Equipment Directive

Hereby, STRATTEC Security Corporation, 3333 West Good Hope Road, Milwaukee, WI 53209 USA declares that this AM Series Key fob is in compliance with the essential requirements and other relevant provisions of Directive 2014/53/EU (RED). The original delegation of conformity can be accessed at the following link www.strattec.com/company/certifications

Frequency band 433.05 - 434.79 MHz.

Maximum Output Power <10 mW.

Vehicle Key Functions



[1] LOCK: Press and release to lock the vehicle and arm the security system.



[2] UNLOCK: Press and release to unlock either the driver's door or the vehicle (Refer to 'One Step Unlocking', page 2.3).







[3] DECK LID OPEN: Press and hold to release the deck lid catch.





One Step Unlocking

The vehicle key can be set to either unlock only the drivers door on a single press of  or all vehicle doors.

To cycle between single door unlock and full unlock, press and hold  and  at the same time for 6 seconds.

 If the vehicle is set to only open the driver's door, a second press of  will open all vehicle doors.

 Lock operation of the fuel filler flap is not affected.

 One Step Unlocking can only be set using the vehicle key.

Vehicle Key Battery

 **Warning: The vehicle key contains a small cell battery. Do not ingest or swallow the battery. If the battery is swallowed, there is a risk of choking, severe internal chemical burns or death. Always keep both new and used batteries away from children and do not allow children to use the vehicle key. If you suspect a battery has been swallowed, immediately seek medical attention.**

Battery Power Conservation

Keyless entry can be deactivated to conserve battery power in the vehicle key.

To deactivate keyless entry, double tap .

To activate keyless entry, press any button on the vehicle key or insert the vehicle key into the emergency ignition switch.

Battery Replacement

To replace the vehicle key's battery:

1. Lift the battery cover (A).

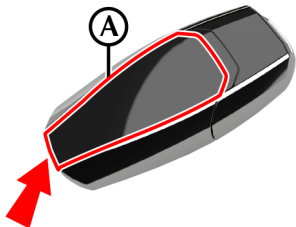

2. Push down on the battery to tilt the battery (B) and allow access.



3. Remove the battery and install the new battery with the (+) sign facing up.
4. Replace the battery cover.

Keyless Start Failure

If the vehicle does not start because the charge in the vehicle key battery is too low, use the emergency start procedure (Refer to 'Emergency Engine Start', page 2.12).

Unlocking and Opening

Keyless Go Zones

The Keyless Go function for vehicle locking and ignition will operate when a vehicle key is inside the vehicle cabin or in one of the below reception zones:

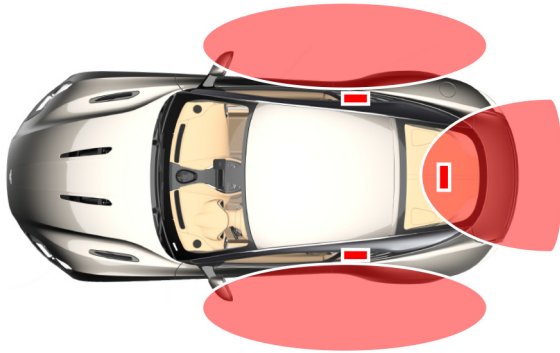

 The vehicle key is only needed in one of the reception zones for Keyless Go. For example, the vehicle key can be in the rear reception zone and the passenger side door can be unlocked.

Unlocking From Outside the Vehicle

Using The Vehicle Key

Stand within 5 m (16 ft) of the vehicle, and press . To show that the security system has been disarmed and the vehicle unlocked, the direction indicators will flash twice¹.

Push at point (A) to release the handle and pull to open the door.

 The driver's door can be set to unlock with the first press of the button and the rest of the vehicle with a second press (Refer to 'One Step Unlocking', page 2.3).

 For ease of use at night white LEDs are incorporated into the door handles which illuminate when the vehicle is unlocked. The door LEDs will go off after 40 seconds or if the vehicle is locked again.

Global Close

Press and hold  to unlock all vehicle doors and open all windows.

Press and hold  to lock all doors and close all windows.

When global close is used, the convertible roof will also open or close with the windows respectively.

¹ An audible confirmation can also be set in the vehicle settings (Refer to 'Vehicle Settings', page 10.2)

Using Keyless Entry

To unlock the vehicle with keyless-entry active, fully push at point (A) and open the door handle. The front edge of the door handle will press a switch and the door will unlock and open.

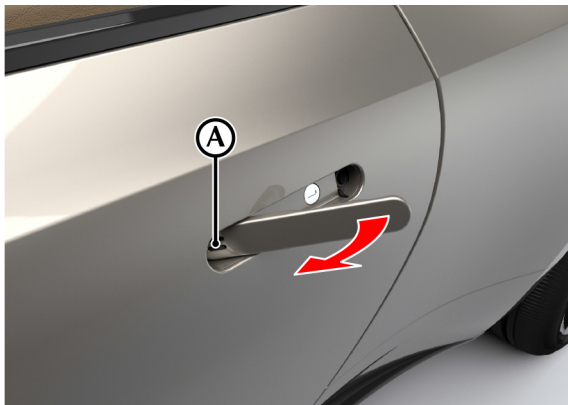

If a door is opened while driving a warning sound will be heard and a warning will be shown on the instrument cluster until the door is closed again.



Automatic Locking

If the vehicle is unlocked but a door is not opened within 40 seconds, the vehicle will automatically lock and arm again.

Locking From Outside the Vehicle

Using The Vehicle Key



Close all the vehicle doors. Stand within 5 m (16 ft) of the vehicle, point the vehicle key towards the vehicle and press . The direction indicators will flash and all vehicle doors will lock. If automatic fold-in mirrors has been set to on in the vehicle settings, the mirrors will fold closed when the vehicle is locked, and open when unlocked (Refer to 'Vehicle Settings', page 10.2).

 If  is pressed with the driver's door open, the vehicle will not lock until that door has been closed.

Using Keyless Entry

Close all the vehicle doors. Press the rear edge of a door handle to activate the lock switch.

Interior Lock Switches

The doors can be locked and unlocked by using the master unlock  (1) and lock  (2) switches.



If the vehicle is locked using the master lock switch, one pull of a door handle will centrally unlock the doors and will open that door.

If the vehicle is not locked using the vehicle key, the master lock switch will operate seven minutes after the ignition control has been turned off.

 *In the event of a vehicle accident the doors will automatically unlock.*

Automatic Locking Feature

The central locking can be set to automatically activate once the vehicle speed exceeds 3 km/h (2 mph).

The automatic locking feature can be activated or deactivated by pressing and holding either the master lock or unlock buttons.

The automatic locking feature can also be activated or deactivated in the vehicle settings menu (Refer to 'Vehicle Settings', page 10.2).

 *The vehicle must be stationary to change the status of the automatic locking feature.*

Easy Entry/Exit

⚠ The Easy Entry/Exit function could cause an occupant to become trapped and/or cause injury. Keep clear of the steering wheel when the Easy Entry/Exit function is used.

📖 Easy Entry/Exit movement can be cancelled by moving the adjustment lever for the steering column or by selecting a memory position.

To aid entry and exit from the vehicle, the steering wheel can be set to move when the driver's door is opened.

Easy Entry/Exit can be set in the vehicle settings menu (Refer to 'Vehicle Settings', page 10.2).

Deck Lid

Volante Only

Decklid operation will be disabled when the tonneau cover for the convertible roof is open. Fully open or close the convertible roof to be able to access the luggage compartment.

Opening The Deck Lid Outside the Vehicle

Press and hold  (A) on the vehicle key to enable the release catch and lift the deck lid.



📖 If the vehicle is locked when  is pressed, the doors will remain locked and the security system will still be armed.

Opening the Deck Lid Inside the Vehicle

Press and hold the deck lid release button (B). The deck lid catch will release. Lift the lid.



Hands-Free Access

⚠ Warning: Make sure there is sufficient clearance under the rear of the vehicle and that you stand on firm ground. It is possible you could lose your balance on some surfaces, such as on ice.

⚠ Warning: The vehicle exhaust system can become very hot. To prevent injury make sure you only move your foot in the detection range of the sensors .

⚠ Caution: Do not touch the bumper when you move your foot to operate the system. If you do, you can cause damage the bumper.

📖 The hands-free access system may not function correctly if there is a build-up of dirt, road salt or snow around the sensors.

📖 It is possible the deck lid could be released unintentionally, such as when the rear bumper is being cleaned, or in an automatic car wash. Do not carry the vehicle key with you in such situations. This will prevent unintentional opening or closing of the deck lid.

Hands-free access can be used to release the catch for the deck lid. To operate, quickly move your foot under the rear bumper.

For the hands-free access system to operate:

- The vehicle key must be in the rear Keyless Go detection area of the vehicle (Refer to 'Keyless Go Zones', page 2.5).
- The engine must not be running.

 *If the deck lid does not release after several attempts, wait at least 10 seconds before you try again.*

If you hold your foot under the bumper for too long, the deck lid will not release.

Closing the Deck Lid

Push the deck lid down and make sure that the catch engages. Once the catch engages, it automatically closes. If the deck lid is slammed shut, this is overridden.

If a vehicle key is left in the luggage compartment and the deck lid is closed, but the rest of the vehicle is locked, the latch will not engage. The key(s) must be removed from the luggage compartment before the deck lid can be locked. If a second key is in range outside the vehicle the latch will engage and lock the deck lid. There will also be an audible or visible lock confirmation dependant on settings.

Emergency Access and Start

Emergency Key

If the vehicle key fails to operate, or the vehicle battery is fully discharged, use the emergency key to lock or unlock the vehicle.

 Do not store the emergency key in the vehicle. If the vehicle battery is fully discharged you will need the emergency key to gain access to the vehicle.

 If the emergency key is lost, contact your Aston Martin Dealer.

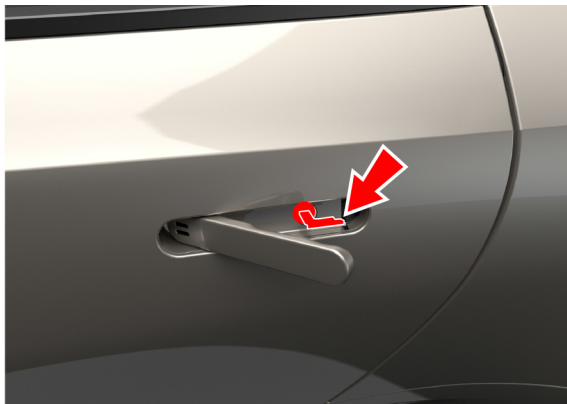

 The emergency door lock is always in the door handle for the left side door.

Open the door handle and insert the emergency key in the door lock and turn clockwise. Only that door will be unlocked. If the security system was armed, the alarm will start. To stop the alarm insert the vehicle key (even if the vehicle key has lost all power) into the emergency ignition slot and move to position 'II' (ignition ON).

 **Caution:** If the vehicle has lost power, the door may require extra effort to open due to the window not dropping down. If this does happen, gently press against the top of the window whilst opening the door.

 **Caution:** If the vehicle battery is fully discharged, the emergency key will only lock or unlock the left side door. The right side door can be unlocked from inside the vehicle, but unless power is supplied to the vehicle, that door cannot be locked again.

 Even if the vehicle key has lost all power it will start the engine when used in the emergency ignition slot.

Emergency Deck Lid Release

The deck lid can be opened from inside the luggage compartment by pulling the luminous emergency release handle (A).

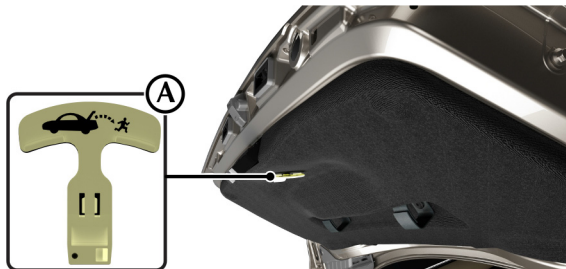

Emergency Engine Start

If the keyless start system fails to start the vehicle, the engine can be started with the emergency start system.

To start the engine:

1. Lift the battery cover (A).

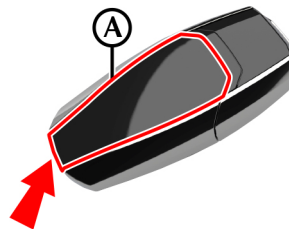

2. Press the cap release button (B) and remove the key end cap (C).

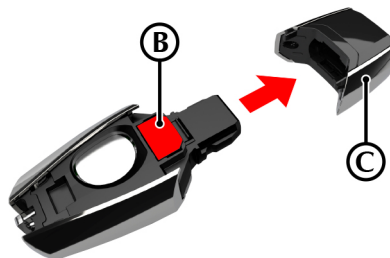



3. Move the armrest back to at least position "1" (Refer to 'Powered Storage Box', page 3.40) to expose the cup holders and the emergency ignition cover.
4. Remove the emergency ignition cover (D).





5. Insert the key into the emergency ignition slot and turn the key clockwise to start the vehicle.



 If the keyless ignition system fails, contact your Aston Martin Dealer.

 If the emergency ignition is used to start the vehicle, the **START** button is disabled.

 To turn the engine off, turn the key counter-clockwise in the emergency ignition slot.

 The powered arm rest will not be able to fully close when the vehicle key is in the emergency ignition slot.

Anti-Theft Systems

Introduction

This vehicle is protected by an electronic security system which includes:

- Remote arm and disarm
- Perimeter sensing
- Remote door, deck lid, fuel flap lock and unlock
- Alarm siren with battery backup (Only in markets where audible sirens are permitted.)
- Random code encryption to prevent electronic scanning of the vehicle key identity code
- Engine Immobiliser
- Ultrasonic Interior movement sensors
- Tilt (tow-away) sensor

When the security system is armed, any attempt to gain access by breaking a window or forcibly opening a door, the deck lid or the bonnet will result in full alarm operation.

Alarm

When the alarm has started a siren will be heard for a 25 seconds cycle (ten cycles maximum) and the direction indicators flash¹ for five minutes after which the security system returns to the armed state.

The doors and deck lid will stay locked throughout.

Stop the alarm at any time by pressing  on the vehicle key or open a vehicle door with keyless entry active. There is approximately a ten second delay before the alarm is stopped.

Engine Immobiliser

The engine immobiliser prevents your vehicle from being started without the correct key.

The immobiliser system is activated when the ignition is set to off and the driver's door is opened.

! Caution: Always take the key with you when you lock the vehicle. The engine can be started if a valid key has been left inside the vehicle.

¹. Markets where visible alarm signals and audible sirens are permitted.

Interior Motion Sensor

When the vehicle is locked and armed, the interior motion sensor will sense movement inside the vehicle. If movement is detected it will start the alarm.

 *The interior motion sensor will activate 10 seconds after the vehicle is locked and all doors and the deck lid are closed, and the alarm will be set after a further 10 seconds of calibration.*

 *All doors must be closed before the interior motion sensor can be activated.*

The interior motion sensor can be set on or off in the vehicle settings menu (Refer to 'Vehicle Settings', page 10.2).

Tow Away Protection

When the vehicle is locked and armed a tilt sensor will sense if the vehicle is tilted or lifted. For example, if the vehicle is being raised on a jack or being towed. If the vehicle tilt sensor detects a tilt, the alarm will start.

 *Tow Away Protection will activate 60 seconds after the vehicle is locked and all doors are closed.*

 *All doors, including the deck lid, must be closed before tow away protection can be activated.*

Tow away protection can be set to on or off in the vehicle settings menu (Refer to 'Vehicle Settings', page 10.2).

Option - Not available in all markets.

The Aston Martin Tracking system uses Global Positioning Satellite (GPS) and Global System for Mobile communications (GSM) technology to provide pinpoint accuracy and unparalleled service levels.

Please consult your Aston Martin Dealer for details and subscription rates.

The system provides the following features:

Automatic Driver Recognition

Alerts the Aston Martin Tracking Secure Operating Centre immediately if your vehicle is stolen, even if the thief has your keys.

Engine Start Inhibit

Activated by the Secure Operating Centre with Police authorisation, to prevent the engine from being restarted.

Tamper Alert

Activated when the system battery is disconnected or discharged, or when the system wiring is cut.

Tow-Away Alert

Activated when motion is detected with the ignition switched off and the driver card is not present.

System Health Check

Regular automatic self diagnostic check.

Transport Mode

Set by the Secure Operating Centre when the vehicle owner has confirmed the vehicle is being transported. This will prevent false alerts being generated.

Vehicle Servicing Mode

Set by the Secure Operating Centre when the vehicle has been given to the Aston Martin Dealer for maintenance.

Theft History

Minute by minute theft log helps Police secure convictions.

Pinpoint GPS Tracking

Allows tracking operation centre to be accurate to within 10 metres.

International GSM Coverage

Roaming SIM card gives coverage across more than 180 countries.

European Coverage

Local language Police liaison and stolen vehicle recovery across Europe.

Countries covered by Aston Martin Tracking System:

Albania, Andorra, Austria, Belarus, Belgium, Bosnia, Bulgaria, Croatia, Cyprus, Czech Republic, Denmark, Estonia, Finland, France, Germany, Gibraltar, Greece, Hungary, Ireland, Italy, Latvia, Liechtenstein, Lithuania, Luxembourg, Macedonia, Malaysia, Malta, Monaco, Montenegro, Netherlands, Norway, Poland, Portugal, Romania, Russia, San Marino, Serbia, Singapore, Slovakia, Slovenia, South Africa, Spain, Sweden, Switzerland, Turkey, Ukraine, United Kingdom, Vatican City.

Insurance Accreditation

Conforms to the highest European accreditations for stolen vehicle tracking systems - Thatcham, Incert (formerly Assuralia) and SCM and is approved by major insurers.

How the System Works

The Aston Martin Tracking system is supplied with two unique driver cards. An authorised driver must have a driver card in their possession when using the vehicle.

 *Do not leave the driver card inside the vehicle or with the vehicle key. It should be kept in a safe place and always separately from your vehicle keys.*

The system arms when the vehicle ignition has been switched off for 70 seconds and the driver card is out of range (approximately 3 metres).

The system will automatically disarm when the driver card is in range of the vehicle.

If your vehicle is driven approximately 100 metres and the driver card has not been detected, a silent alert is transmitted to the Secure Operating Centre to inform the advisors of a potential unauthorised movement of your vehicle. The advisor will then contact you.

If the engine has been started and the driver card is not in your possession, switch the ignition off and call the Secure Operating Centre for advice to avoid an alert being generated.

The system will additionally send an alert if:

- Your vehicle is lifted or towed away without the vehicle key.
- Your vehicle battery is disconnected or discharged.
- The GPS antenna has been disconnected.

A monthly health check message will also be sent to the Secure Operating Centre to confirm full system functionality.

If your Vehicle is Stolen

After an alert has been received, the Secure Operating Centre advisor will attempt to contact you using the telephone number(s) supplied at the time of registration. A minimum of two telephone numbers must be provided at the time of activation of the contract.

The Police will not be contacted until the advisors have spoken with you. This is to comply with Police procedures so that Police time is not wasted with false alarms.

Once the theft has been confirmed with you, the advisors will ask you to contact the Police to report the theft and to call the advisor back immediately with a Police incident number. Receipt of an alert does not constitute a confirmed theft, as Police Forces require key holder verification of a theft. The Secure Operating Centre will then liaise with the relevant Police Force to recover your vehicle.

If your vehicle is outside the UK, the Secure Operating Centre work with the Police in their local language across Europe to recover your vehicle quickly.

In order to prevent your vehicle being moved following a theft, the Secure Operating Centre (under Police instruction) may temporarily prevent the vehicle's engine from restarting.

Once the Police have secured the stolen vehicle, arrangements are made with you for the vehicle to be collected. The Police may require it to be taken to a secure compound for further investigation.

You will be liable for any statutory Police recovery and storage charges, payable directly to the Police.

Additional Information

False Alarms

To avoid unnecessary alerts, contact the Secure Operation Centre to inform them of any potential false alarm. Excessive false alerts may result in a charge.

Damage Check

If you are involved in an accident or if your vehicle battery has been disconnected for any reason (for example, body work repair or paint re-spray), you must call Aston Martin Tracking Customer Services so that they can test the system to check that it is still functioning correctly.

Change of Details

You must call Aston Martin Tracking Customer Services if any of your personal details change. For example:

- Change of address.
- Change of mobile phone number.
- Changing the registration plate on the vehicle.
- Selling the vehicle.
- New owner buying a pre-owned vehicle already fitted with Aston Martin Tracking System.

Contact Details

Aston Martin Tracking 24 Hour Secure Operating Centre:

+44 (0) 1282 476 799

Or from abroad:

+44 (0) 333 222 0799

Aston Martin Tracking Customer Services:

+44 (0) 1282 473 732

(Monday to Friday - 09.00 to 17.00)



When registering for the Aston Martin Tracking System, you are also provided with all the details and contact numbers needed if your vehicle is stolen. Keep these details safe and not in the vehicle so you can refer to them if your vehicle is stolen.

Radio Equipment Directive

Driver Card

Hereby, Vodafone Automotive SpA declares that the radio equipment types 2781 and 8015 are in compliance with Directive 2014/53/EU. The full text of the EU declaration of conformity is available at the following internet address: automotive.vodafone.com, section download.

The devices have the following RF parameters:

- 2781: 433,92 MHz/-30 dBm
- 8015: 433,92 MHz/-12 dBm

Telematics Unit

Hereby, Vodafone Automotive SpA declares that the radio equipment types 2145 and 2146 are in compliance with Directive 2014/53/EU. The full text of the EU declaration of conformity is available at the following internet address: automotive.vodafone.com, section download.

This device has the following RF parameters:

- 33 dBm for 850 / 900 MHz;
- 30 dBm for 1800 / 1900 MHz.

These devices bear the following CE mark: **CE**

 *Note for installation: In order to avoid human exposure to electromagnetic fields, the distance of the VTS device with respect to the body of the vehicle occupants must be greater than 0.2m.*

 *Not available in Azerbaijan*

(Optional)

The HomeLink®₁ Wireless Control buttons and transceiver are on the interior rear view mirror. The transceiver can be programmed to operate up to three transmitters to operate garage doors, entry gates, home lights, security systems, or other radio frequency operated devices.

! Caution: As a security precaution make sure that all programming is erased in the HomeLink system before selling this vehicle.

For information or assistance, contact your Aston Martin Dealer.

¹ Gentex®, HomeLink®, and the HomeLink® house icon are registered trademarks of Gentex Corporation.

⚠ Warning: When the transceiver is being programmed to a garage door opening system, make sure that people and animals, the vehicle and objects are clear to prevent injury or damage as the garage door or gate will operate during the programming.

📖 A full list of radio frequency operated devices can be either obtained on the HomeLink website.

📖 Keep the original transmitter for future use or programming procedures if, for example, you purchase a new vehicle.

📖 This device may suffer from interference if operated near to a mobile or fixed station transmitter. This interference can affect the hand-held transmitter as well as the in-vehicle transceiver.

📖 The manufacturer is not responsible for any radio or TV interference caused by unauthorised modifications to this equipment. Such modifications could void the user's authority to operate the equipment.

Programming

📖 Step 1 will clear previously programmed devices and is only necessary if programming HomeLink for the first time or when erasing all existing programming. This step is not necessary to program additional devices. The HomeLink® buttons can be reprogrammed individually but not individually erased

1. Press and hold the two outer HomeLink buttons until the HomeLink symbol (A) begins to flash green after 10 seconds.



Release the two buttons. All three buttons are now cleared, and the HomeLink system is now in setting mode.

2. Press the HomeLink button you want to program. the HomeLink symbol should begin to slowly flash orange.
3. Press and hold the remote control for the device to be programmed at a distance of 20 mm to 200 mm (1" to 9") away from the HomeLink transmitter unit, keeping the HomeLink symbol in view.

 *The distance between the remote control and the transmitter unit depends on the system being programmed and several attempts at different distances may be necessary.*

4. Press and hold the remote control button until the HomeLink symbol turns to either rapidly flashing or continuously green.

 *Some markets require the remote control to time out after it's button is pressed and held for a certain amount of time. If the indicator light on the remote control goes off whilst programming, press and release the remote control button every 2 seconds until the symbol changes to green.*



5. Press the newly programmed HomeLink button.
 - If the symbol stays constantly green, programming is complete and your device should operate when the HomeLink button is used.
 - If the symbol rapidly flashes green, press and hold the HomeLink button for two seconds twice. Depending on the brand of the device, you may need to press and hold for a third time to complete the programming process. At this point if your device operates, programming is complete.
 - If the your device does not operate, refer to you device's manual to see if there are steps required on your device to complete the programming of a rolling code equipped device.

Operation

The vehicle should be within the operating range of the device and the ignition should be ON.

The HomeLink system operates the garage door opener (or other device) in the same way as the original remote control.

 *The original remote control may also be used at any time.*



Press the programmed HomeLink button to operate the device. The HomeLink symbol will come on when the button is pressed and will stay on while the garage door opener (or other device) operates.

Reprogramming

To program a new device, press and hold the desired HomeLink button for 20 seconds until the LED starts flashing slowly. That button may now be programmed to work with a different device.

 *If you do not complete programming the new device, the previous device will still be programmed to that button.*

Radio Equipment Directive

Hereby, Gentex Corporation declares that HomeLink® Model UAHL5 is in compliance with Radio Equipment Directive 2014/53/EU. The full text of the EU Declaration of Conformity is available at the following internet address: <http://www.homelink.com/regulatory>

Frequency Bands in which the radio equipment operates:

- 433.05MHz-434.79MHz <10mW E.R.P.
- 868.00MHz-868.60MHz <25mW E.R.P.
- 868.70MHz-869.20MHz <25mW E.R.P.
- 869.40MHz-869.65MHz <25mW E.R.P.
- 869.70MHz-870.00MHz <25mW E.R.P.



ASTON MARTIN

Before Driving

Checks Before Driving.....	3.2
Seat Adjustment	3.2
Windows.....	3.5
Mirrors	3.6
Steering Column	3.8
Memory Functions	3.9
Occupant Restraint System	3.10
Child Safety.....	3.18
Child Seats - ISOFIX Installation.....	3.23
Child Seats - Seat Belt Installation	3.37
Storage.....	3.39
Variable Load Space.....	3.42
Accessory Sockets.....	3.43

Checks Before Driving

Inspect your vehicle to make sure that everything is according to the information and specifications in this Owner's Guide.

Outside the Vehicle:

- Visually check the road wheels, wheel bolts and tyres.
- Check that all windows, mirrors and lamps are clear and unobstructed.
- Check that the deck lid, bonnet and fuel filler flap are securely closed.
- Check the operation of all lamps.

Once Inside the Vehicle:

- Check that the doors are securely closed.
- Check that the seat, mirrors and steering wheel adjustments are correct.
- Check that all gauges and symbols are reading correctly.
- Check that all passengers have fastened their seat belts.

Seat Adjustment

Front seats only.

⚠ Warning: Do not adjust the drivers seat whilst driving.

The seats can also be adjusted:

- Up to 6 minutes after a door is unlocked and before the ignition is switched on.
- Up to 6 minutes after the ignition is switched off.

If the seat operation times out:

- Turn the ignition control on.
- Close or open a door.

The seat adjustment controls are located each side of the centre console.

Seat Controls

 The ignition must be on before the lumbar and bolster support¹ can be operated.

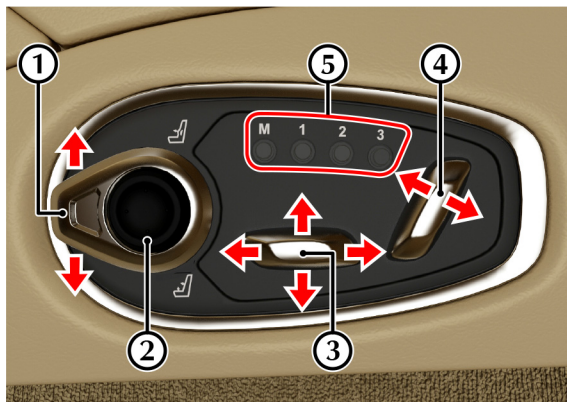

[1] LUMBAR/BOLSTER ADJUSTMENT SELECTOR SWITCH:

Press the switch up to select lumbar adjustment. Press down to select bolster adjustment¹.

[2] LUMBAR/BOLSTER ADJUSTMENT: Use the directional pad to adjust the position of the lumbar or bolster support¹.

[3] SEAT POSITION ADJUST: Seat forward/backward and height adjust. Raise front to tilt base of seat.

[4] SEAT BACKREST ADJUST: Seat back angle adjust.

[5] MEMORY SEAT POSITIONS: Use to select or store memory positions for the seat, steering column and door mirror positions (Refer to 'Memory Functions', page 3.9).

Seat Back Release

 **Caution:** Make sure that the headrest for the seat does not hit the sun visor. The seat can cause damage to the sun visor or the sun visor mirror.

Pull the release strap (A) to release the seat back.

Pull and hold to move the rear of the seat forward.

¹. Optional

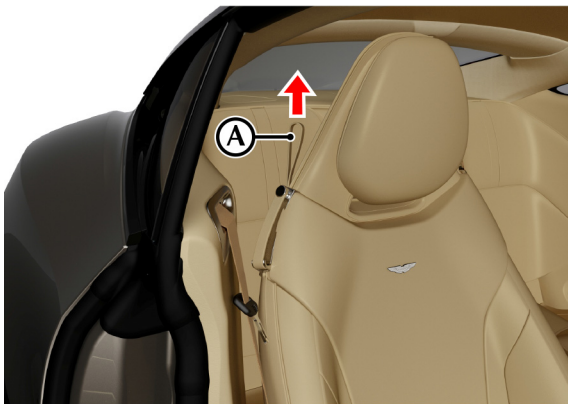

Push the rear of the seat into position to lock it in place.

 A warning message will be shown in the instrument cluster if the seat is not correctly locked back into position.

The driver and front passenger seats include non-adjustable head restraints, which limit the rearward travel of the head in a rear impact and may reduce whip lash injuries. When sitting in the seats make sure that the seat back is in an upright position and that the rear of the occupant's head is positioned in the centre of the head restraint area. The head restraints are most effective when the distance between the rear of the occupant's head and the head restraint is kept to a minimum.

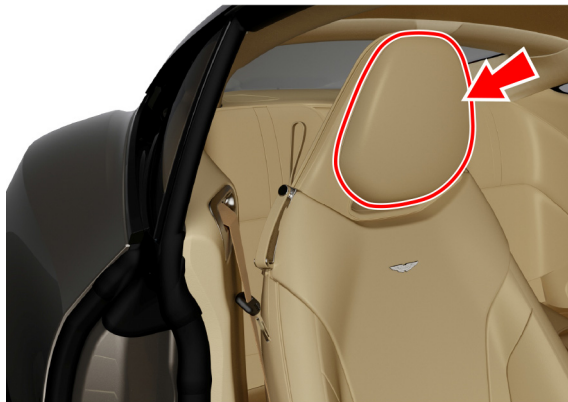

Windows

⚠ Warning: Misuse of the window switches, especially by children, can result in injury due to entrapment in the window closure. Drivers must advise all passengers of the possible danger and make sure that all obstructions are clear before raising the window.

 The windows can be operated up to one minute after the ignition is turned off.

To raise and lower the windows the ignition must be on.

Use a window switch on the driver's side (A) or the passenger's side (B) to operate a window.



Press or pull past resistance on the window switch to perform a one-touch movement down or up.

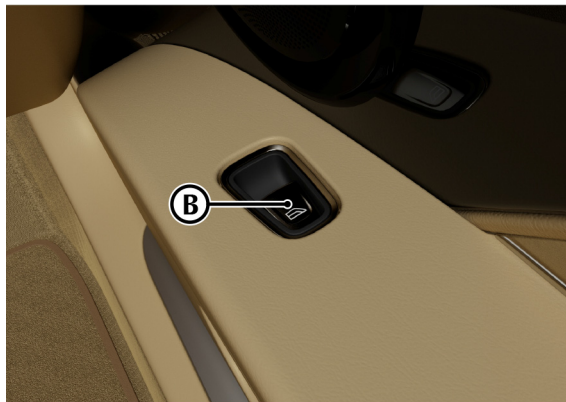

If power to the electric windows has been interrupted for any reason, they will fail to operate correctly until reset.

Mirrors

Interior Mirrors

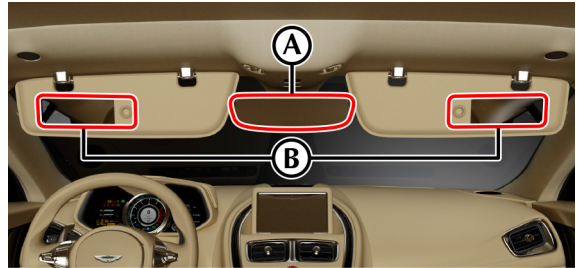

Automatic Dim

Adjust the mirror (A) on its ball mounting until a satisfactory rear view is obtained.

The rear view mirror will dim automatically if the glare from the headlamps of following vehicles becomes too bright. The mirror will return to normal view as unwanted glare reduces to an acceptable level.

Illuminated Vanity Mirror

A vanity mirror (B) is located in each sun visor. Fold the sun visor down and slide the cover to view the mirror.

Door Sealing

⚠ Warning: Make sure that all passengers are clear when the window mechanism is operating.

To minimise wind noise and to make sure that the window seal is watertight, a door sealing system is used to provide a tight fit of the door glass to the seals around the top of the door opening.

The window automatically lowers a small distance to clear the door seal when a door is opened. When the door is closed, the window automatically lifts against the body frame rubber seals.

Window Anti-Trap

The door windows use an anti-trap mechanism to prevent accidental closure of a window on vulnerable parts of the body or other obstructions. When the window motor sense an obstruction, the window stops closing and then opens to release the obstruction.

Exterior Mirrors

To adjust the exterior mirrors press the mirror switch (A) left or right to select a side to adjust. Move the direction pad (B) up, down, left or right to adjust the selected mirror.

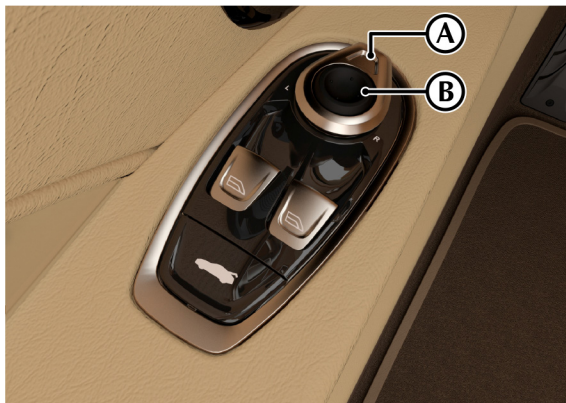

 The ignition control must be on before the door mirrors can be adjusted.

Heated Mirrors

The heated door mirrors will operate when the heated rear window is switched on.

Mirror Fold

To fold the mirrors, press and hold the mirror switch (A) to the left or right.

Auto-Fold

When the vehicle is locked using the vehicle key or master lock switch, the mirrors will automatically fold in. The mirrors will return to the driving position when the vehicle is unlocked.

This function can be enabled or disabled in the systems settings menu (Refer to 'Vehicle Settings', page 10.2).

Memory Function

The position of the exterior mirrors is stored when a seating position is saved for the driver's seat.

Reverse Dip Function

To set a position for the reverse dip mirror, use the mirror switch to set a position for the passenger side mirror with reverse gear selected. The mirror will now move to the position when reverse gear is selected, if the driver's side mirror is not selected. If the driver's side mirror is selected the mirror will not move. Select the passenger side mirror to dip the passenger side mirror.

Steering Column

Adjustment

⚠ Warning: Do not adjust the steering column whilst driving.

 The steering column can be adjusted with the ignition set to OFF.

The reach and tilt angle of the steering column are adjusted with the adjustment stalk. Push the stalk down or up to adjust the steering column angle. Pull the stalk towards you to bring the steering wheel closer and away to move the steering wheel back.



Heated Steering Wheel

 The ignition must be on before the heated steering wheel can be operated.

To set the steering wheel heating to on, rotate the end of the adjustment stalk towards you. The indicator LED lamp will also come on.

To turn the steering wheel heating off, rotate the stalk away.

 The steering wheel heating is always set to off when the ignition is set to off.

Memory Function

The position of the steering column is stored when a seating position is saved for the driver's seat (Refer to 'Memory Functions', page 3.9).

Memory Functions

⚠ Warning: Make sure that there is nothing in the movement path of the seat or the steering column during adjustment that could cause obstruction.

⚠ Warning: To avoid injury, make sure that children do not play with the memory position switches.

⚠ Warning: If the seat or steering column accidentally begin to move, press any seat control button to stop the seat.

📖 Lumbar and Bolster positions are not recorded when memory positions are saved.

The position of the driver and front passenger seats, steering column and exterior mirrors can be memorised and recalled.

Three different driving position profiles can be entered in the memory. The memory position of the steering column and both door rear view mirrors are saved in the driver's seat position.

Setting a Memory Position

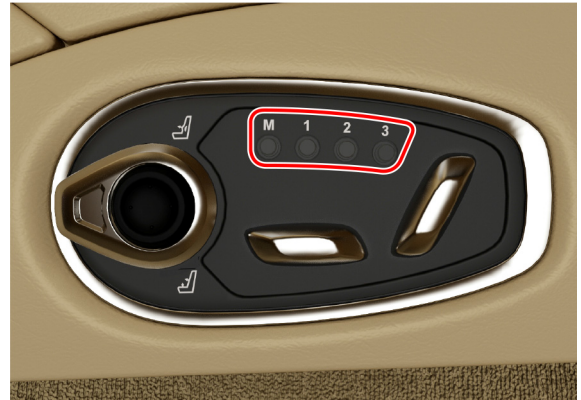

Occupant Restraint System

To Save A Memory Position

⚠ Warning: Do not attempt to adjust the driver's seat whilst driving.

Adjust the seat, steering column and the exterior rear view mirrors to the desired position. Push the memory button (M), then press the required memory channel (1, 2 or 3) to save the positions. A chime is heard and a message will show in the message centre to confirm. By repeating these steps and pressing an unused button, a second and third driving position can be saved in the memory.

Recalling a Memory Position

Once in the seat press button 1, 2 or 3 (depending on which saved channel is required) until all movement is stopped. The seat will move to the saved position.

Seat and steering wheel movement will be interrupted if the memory channel button is released. Exterior mirror movement will continue. Press and hold the memory channel button to complete seat and steering wheel movement.

Emergency Stop

If the seat accidentally begins to move, press any seat control button to stop the seat.

The system provides protection to the driver and all passengers in a variety of impact conditions.

The system consists of:

- Driver and front passenger safety belts with dual pretensioners and load limiting systems.
- Driver and front passenger dual-stage airbags.
- Driver and front passenger seat side airbags.
- Front Passenger Airbag Deactivation (PAD) switch (Market specific).
- Driver and front passenger roof mounted curtain airbag (coupe).
- Driver and front passenger door mounted curtain airbag (volante).
- Driver knee bolster airbag.
- Roll Over Protection System (ROPS) (volante)

All of these systems are controlled by the Occupant Restraint Controller (ORC). In a collision the ORC will analyse information from various sensors, such as crash and seat occupancy conditions. Based on this information the system will deploy the appropriate safety devices. During a crash, the ORC may or may not operate the safety belt pre-tensioner(s) and none, one, or both stages of the dual-stage airbag supplemental restraints.

If the pre-tensioners or airbags do not operate in a collision it does not mean that something is wrong with the system. Rather, it means the system determined the accident conditions (crash severity, belt usage, etc.) were not appropriate to operate these safety devices.

Front airbags are designed to operate only in frontal and near-frontal collisions, not rollovers, side-impacts, or rear-impacts unless the collision causes sufficient longitudinal deceleration.

Determining if the System is Operational

The ORC warning symbol is shown in the instrument cluster  to give the condition of the system. A fault with the system is shown by one or more of the following:

- The warning symbol will flash or stay ON.
- The warning symbol does not come ON immediately after the ignition is set to ON.
- A message will show in the right side instrument cluster window with a description of the fault.

If either of these conditions occur, even intermittently, have the restraint system serviced at your Aston Martin Dealer immediately. Unless serviced, the system may not operate correctly in the event of a collision.

Seat Belts

⚠ Warning: *Seat belts should not be worn with straps twisted.*

⚠ Warning: *Seat belts are designed for adults; infants and smaller children must be restrained in an approved child safety seat.*

⚠ Warning: *Each belt assembly must only be used by one occupant; it is dangerous to put a belt around a child being carried on the passengers lap. Do not put an adult seat belt around two children.*

⚠ Warning: *When installed, the seat belt webbing must not contact any sharp edges which could abrade or cut the webbing during normal use or in an accident. If necessary, the webbing must be protected.*

⚠ Warning: *Care should be taken to avoid contamination of the webbing with polishes, oils and chemicals, and particularly battery acid. Cleaning may safely be carried out using mild soap and water. The belt should be replaced if webbing becomes frayed, contaminated or damaged.*

⚠ Warning: *Wearing your seat belt is crucial to your safety. Not wearing a seat belt increases chance of serious injury or death in the event of an accident.*

⚠ Warning: *Be sure that you and your passengers always fasten their seat belts and use them correctly even though airbags are provided.*

⚠ Warning: *Reclining the seat back decreases protection provided by the seat belt in the event of a crash. Adjust the seat back to an upright position. Make sure that the seat back is locked in place, otherwise it could move forward in the event of a sudden stop or crash and cause injury.*

⚠ Warning: *Seat belts are designed to bear upon the bony structure of the body, and should be worn low across the front of the pelvis, chest and shoulders; wearing the lap section of the belt across the abdominal area must be avoided.*

⚠ Warning: *Never place the shoulder portion of belt under your arm or behind your back.*

⚠ Warning: *Always remove rigid or breakable objects i.e. spectacles or a mobile phone, from your pockets. These items could be trapped under seat belts, possibly causing injury in the event of an accident.*

⚠ Warning: *Expectant mothers should seek medical advice on the most appropriate way to wear the seat belt.*

⚠ Warning: *Seat belts must be kept clean so that the retractor works correctly. Make sure that belt webbing is not twisted, looped, frayed or obstructed in any way. If in doubt about condition or operation of seat belt installation, have it checked by your Aston Martin Dealer.*

⚠ Warning: No modifications or additions should be made by the user which will either prevent seat belt adjusting devices from operating, or prevent seat belt assembly from being adjusted to remove slack. Never install accessories on your seat belts.

⚠ Warning: Seat belts should be adjusted as firmly as possible, consistent with comfort, to provide the protection for which they have been designed. A slack belt will greatly reduce the protection afforded to the wearer.

⚠ Warning: It is essential to replace the entire seat belt assembly after it has been worn in a severe impact even if damage to the seat belt assembly is not obvious.

⚠ Warning: If it is necessary to replace a seat belt on this vehicle then it MUST be replaced with an approved seat belt. The approved seat belts for the front seats must also include a load limiting system.

Pre-tensioner and Load Limiting

Front seat belts are equipped with dual pre-tensioners and load limiting systems.

In most moderate frontal or near frontal accidents, the front airbag and all pre-tensioner systems will deploy simultaneously. The pre-tensioners take up slack in the seat belts as the airbags are expanding. The load limiting system releases belt webbing in a controlled manner to reduce belt force on a passenger's chest.

 *In some moderate frontal or near frontal accidents, only the pre-tensioner system will deploy.*

Seat Belt Reminder



The seat belt reminder warning symbol in the instrument cluster will come ON and warning sound will be heard for six seconds (approximately) when the ignition is set to ON if the driver or passenger¹ seat belt is not fastened. (Market dependent.)

If the driver seat belt is not fastened after 60 seconds or if the vehicle has reached a speed of 25 km/h, a warning sound will be heard for 30 seconds, after which the warning sound will go off, but the warning symbol will continue to show until the seat belt is fastened.

¹. If a passenger is sitting in the front passenger seat.

Seat Belt Fastening

 When parked on an incline, the seat belt may lock as it is withdrawn. This is not a fault. If the mechanism locks, release the belt tension and then pull the belt very gently to avoid operation of the inertia lock.

Each seat has three point, inertia reel seat belts installed. Items 1, 2 and 3 show the three points of the seat belt. Item 3 is also the location of the belt buckle.



The inertia belt reels will automatically tension the belts to provide security with comfort. In the event of a collision or during severe braking, the belt reels will lock.

To test the locking function of the retractor, quickly pull the seat belt forward. If the seat belt does not lock, consult your Aston Martin dealer.

Pull out the seat belt, drawing the buckle over the shoulder and across the chest.



Push the buckle into the belt buckle latch until a positive click is heard.

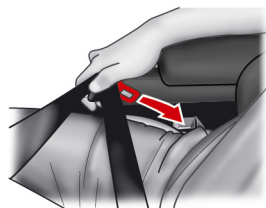

Pull upwards on the diagonal belt to make sure that the latching is secure and to remove all slack from the belt.

Check that the lap belt is installed snugly, low down across the hips, and that there are no twists.

If it is necessary for a passenger to adjust their seat or seating position during a journey, the belt tension might be disturbed. The passenger should therefore (as soon as it is safe to do so) gently pull down the shoulder run of the seat belt to create some slack and then immediately release it to re-tension the belt for the new seating position.



Seat Belt Unfastening

Push the button on the buckle. While holding the seat belt buckle, allow the belt to slowly retract to its stored position.



⚠ Warning: Do not allow the belt to twist, or be looped, frayed or obstructed in any way when the seat belt is retracted back into its stowage position.

Airbags

The purpose of the airbags is to provide additional protection for the driver and passengers in the event of a serious impact (front or side impacts). The airbags are supplementary to the seat belts. Important airbag safety labels are located on the sun visors and on the end of the instrument panel (passenger side). Make sure that the instructions on these labels are read and complied with before driving the vehicle.

The front driver's (A), passenger (B) and knee bolster airbag (C) only deploy in a serious front collision.

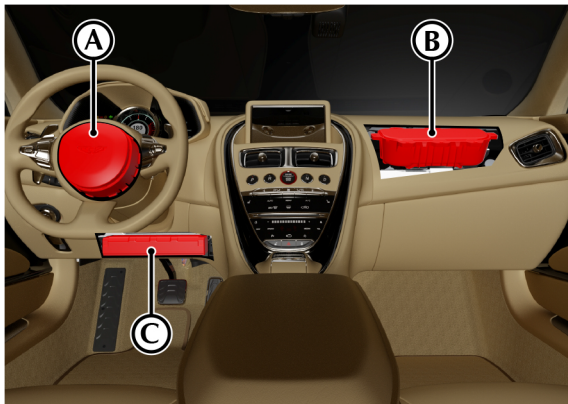

The side airbags (D) located in the front seats and the curtain airbag (E), located in the roof trim¹ or door², only deploy according to which side has been impacted in a serious side collision.

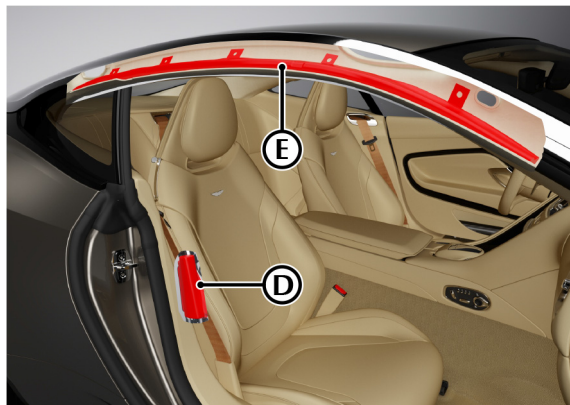

1. Coupe Only
2. Volante Only

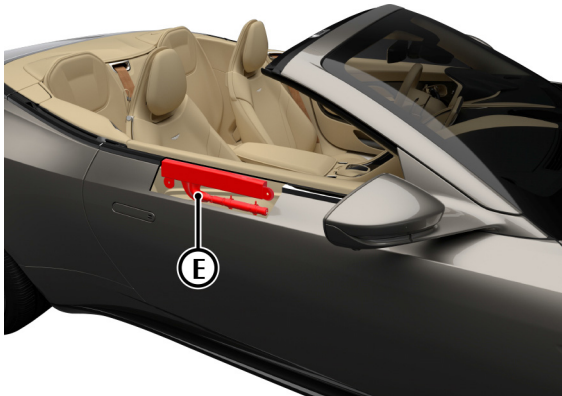

Airbag Deployment

⚠ Warning: The use of accessory seat covers may prevent the deployment of the seat side airbags and increase the risk of injury in an accident. Do not use accessory seat covers.

⚠ Warning: All passengers, including the driver, should always wear seat belts, whether or not an airbag is provided, to decrease the risk of injury or death in the event of a crash.

⚠ Warning: No objects whatsoever should be attached to, or placed on, the centre cover of the steering wheel or the front passenger fascia panel. Such objects could cause harm if the vehicle is in a collision severe enough to cause the airbags to deploy.

 The airbag system is not designed to protect against rear impacts.

Child Safety

Airbags inflate rapidly and with considerable force; there is therefore a risk of death or serious injury such as fractures, facial and eye injuries or internal injuries, particularly to passengers who are not correctly restrained by seat belts or are not sitting correctly when the airbags deploy. The risk of injury from a deploying airbag is greatest close to the trim panel covering the airbag.

The whole sequence of events from sensing the impact to full inflation of the airbag takes place in a fraction of a second.

Do not change, modify or tamper with the steering wheel, passenger side fascia or any other part of the airbag system. Such actions could disable the system or cause inadvertent airbag deployment.

The system will not deploy in the event of minor frontal or side impacts, such as contacts when parking.

All work on the airbag system must only be carried out by an Aston Martin Dealer.

Aston Martin strongly recommends:

- **That all children are sat in the rear passenger seats.**
- **Always use ISOFIX anchors where available.**
- **Only one child seat be installed to the passenger side of the vehicle at any time.**
- **A child, regardless of age, should always be restrained when travelling in a vehicle.**

⚠ Warning: The seat belt reminder function is only designed to recognise an adult sized occupant and will not be activated by a child seat. If a child seat is to be secured to the front passenger seat with a seat belt, make sure it is correctly installed in accordance with the manufacturer's instructions. A child seat that is not correctly restrained can cause an infant or child to be seriously injured or killed in a crash.

⚠ Warning: Accident statistics show that children are generally safer when correctly restrained in the rear seat than in the front seat. A suitable child restraint, correctly installed and used, provides the highest degree of protection for infants and small children in most accident situations.

⚠ Warning: Do not allow children to travel in a vehicle without being correctly restrained. An appropriate child seat or harness should always be used.

⚠ Warning: Each seat belt assembly must be used by only one passenger. It is dangerous to put a seat belt around a child being carried on the passengers lap.

⚠ Warning: Make sure that an installed child seat does not rest against the door, that the child sits correctly in the seat and does not lean close to, or against, the door or window.

Your vehicle has the following devices for the installation of child restraints:

- Passenger Airbag Deactivation (PAD). (Refer to 'Passenger Airbag Deactivation', page 3.20)
- Rear seat ISOFIX anchors with tether anchor points¹. (Refer to 'Child Seats - ISOFIX Installation', page 3.23)
- Front seat ISOFIX anchors with tether anchor point (Optional).
- Passenger seat Automatic Locking Retractor (ALR) seat belts. (Refer to 'Seat Position - Seat Belt Installation', page 3.38)

Child Seat Belt Fastening

⚠ Warning: An infant or child that is not correctly restrained can be seriously injured or killed in a crash. Seat belts are designed for adults; infants and smaller children must be restrained in an approved child safety seat.

Make sure that there is no slack in the webbing and that the restraint installs correctly across the child's rib cage and hips. These are the parts of the body most able to take the force of impact.

The lap strap should pass across the top of the child's thighs, bearing on the pelvis, not on the abdominal area.

¹. Tether anchors on coupe only

Passenger Airbag Deactivation

⚠ Warning: Before installing a child seat on the front passenger seat, the front passenger airbag must be set to OFF.

⚠ Warning: Before driving always confirm that the PAD switch is in the appropriate position according to your requirements.

⚠ Warning: With the exception of installing a child seat on the front passenger seat, never set the PAD switch to OFF. The front passenger will not receive the added protection of the airbag. Serious injuries or even death could occur.

 The PAD switch does not set the front passenger seat side impact airbags or the seat belt pre-tensioners to OFF.

Setting the Airbag to ON or OFF

The Passenger Airbag Deactivation (PAD) switch allows the user to manually set the front passenger airbag to OFF. When the PAD switch is set to OFF, a child seat can be installed on the front passenger seat.

The PAD switch is located on the passenger end of the instrument panel and is accessible when the passenger door is open.

Insert the emergency vehicle key into the PAD switch and turn clockwise for the OFF position (airbag off) or counter-clockwise for the ON position (airbag on). Remove the key.

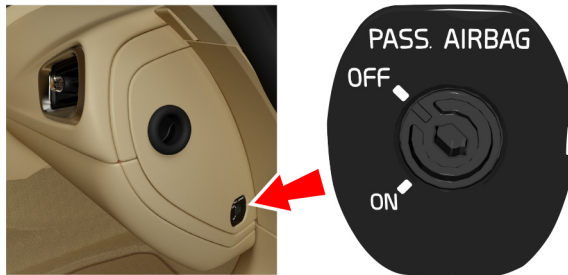







Airbag ON

When the ignition is set to on, make sure that the PASS AIRBAG ON symbol  (A) comes on.





Airbag OFF

When the ignition is set to on, make sure that the PASS AIRBAG OFF symbol  (B) comes on.

 If the PAD switch is set to OFF when the ignition is set to on, the  status symbol will show for approximately 6 seconds before changing to .

At ignition ON if the front passenger airbag is set to OFF, then PASS AIRBAG OFF will show in the message centre.

The PAD switch should be inspected by an Aston Martin Dealer if any of the following conditions occur:

- The PAD status symbol does not change from  to  after six seconds when the ignition is set to ON and the PAD switch is set to OFF.
- The PAD status symbol does not show  when the ignition is set to on and the PAD switch set to OFF.
- The PAD status symbol does not show  when the ignition is set to on and the PAD switch set to ON.
- No PAD status symbol is shown.

Child Seats and Front Passenger Airbag

⚠ Warning: *Never place a child in a child seat or on a booster cushion on the front passenger seat if the airbag is set to ON.*

⚠ Warning: *With the exception of installing a child seat on the front passenger seat, do not set the PAD switch to OFF, as the front passenger will not receive the added protection of the airbag. Serious injuries or even death could occur.*

In the event of a serious frontal or side collision the vehicle airbag system is designed to deploy, to provide additional protection for the front seat occupants.

If a child seat is to be used in the front passenger seat, the front passenger airbag must be set to OFF (Refer to 'Passenger Airbag Deactivation', page 3.20). Make sure that the child seat manufacturer's installation instructions are followed correctly.

 *The PAD switch does not set the front passenger side impact airbags or the seat belt pre-tensioners to OFF.*

Warning Labels

⚠ Warning: *Extreme Hazard: NEVER use a rearward facing child restraint on a seat protected by an ACTIVE AIRBAG in front of it. DEATH or SERIOUS INJURY to the Child can occur.*

Warning labels are located on both sides of the passenger sun visor and on the passenger end of the instrument panel.



Child Seats - ISOFIX Installation

Coupe - All markets with ISOFIX Front seat.

Always follow the child seat manufacturer's instructions. Not following the child seat manufacturer's instructions when installing the child seat is dangerous.

Mass Group		Size Class	Fixture	ISOFIX Positions		
As shown on the child safety seat packaging				Front Passenger with ISOFIX	Driver's side Rear Outboard	Passenger's side Rear Outboard
	Carry Cot	F	ISO/L1	X	X	X
		G	ISO/L2	X	X	X
'0'	Up to 10 kg	E	ISO/R1	IL ₁	X	IL ₂ .
'0+'	Up to 13 kg	E	ISO/R1	IL ₁ .	X	IL ₂ .
		D	ISO/R2	X	X	X
		C	ISO/R3	X	X	X
'1'	9 to 18 kg	D	ISO/R2	X	X	X
		C	ISO/R3	X	X	X
		B	ISO/F2	IUF ₁ .	IUF ₃	IUF ₃ .
		B1	ISO/F2X	IUF ₁ .	IUF ₃ .	IUF ₃ .
		A	ISO/F3	IUF ₁ .	X	X
'II'	15 to 25 kg			X	X	X
'III'	22 to 36 kg			X	X	X

1. Special positioning requirements are needed for the front passenger seat (Refer to 'Front Seats', page 3.28)

2. When a child seat is installed to the rear seat using ISOFIX, you must move the seat directly in front of the child seat to its fully forward and highest position. Move the back of the seat to its fully forward position. The back of the seat must be moved with the seat control switch and not the seat release strap. The front seat should also **NOT** be occupied. (Refer to 'Rear Passenger Seat Installation', page 3.32).

3. When a child seat is installed to the rear seat using ISOFIX, you must move the seat directly in front of the child seat to its fully forward and lowest position. Move the back of the seat directly in front of the child seat to an upright position.

Volante - All markets with ISOFIX Front seat.

Always follow the child seat manufacturer's instructions. Not following the child seat manufacturer's instructions when installing the child seat is dangerous.

Mass Group		Size Class	Fixture	ISOFIX Positions		
As shown on the child safety seat packaging				Front Passenger with ISOFIX	Driver's side Rear Outboard	Passenger's side Rear Outboard
	Carry Cot	F	ISO/L1	X	X	X
		G	ISO/L2	X	X	X
'0'	Up to 10 kg	E	ISO/R1	IL ₁	X	X
'0+'	Up to 13 kg	E	ISO/R1	IL ₁	X	X
		D	ISO/R2	X	X	X
		C	ISO/R3	X	X	X
'1'	9 to 18 kg	D	ISO/R2	X	X	X
		C	ISO/R3	X	X	X
		B	ISO/F2	IUF ₁	X	X
		B1	ISO/F2X	IUF ₁	IUF ₂	IUF ₂
		A	ISO/F3	IUF ₁	X	X
'II'	15 to 25 kg			X	X	X
'III'	22 to 36 kg			X	X	X

1. Special positioning requirements are needed for the front passenger seat (Refer to 'Front Seats', page 3.28)

2. When a child seat is installed to the rear seat using ISOFIX, you must move the seat directly in front of the child seat to its fully forward and lowest position. Move the back of the seat directly in front of the child seat to an upright position.

Coupe - All markets without ISOFIX Front seat.

Always follow the child seat manufacturer's instructions. Not following the child seat manufacturer's instructions when installing the child seat is dangerous.

Mass Group	Size Class	Fixture	ISOFIX Positions	
As shown on the child safety seat packaging			Driver's side Rear Outboard	Passenger's side Rear Outboard
Carry Cot	F	ISO/L1	X	X
	G	ISO/L2	X	X
'0'	Up to 10 kg	E	ISO/R1	X
'0+'	Up to 13 kg	E	ISO/R1	X
		D	ISO/R2	X
	C	ISO/R3	X	X
	'1'	9 to 18 kg	D	ISO/R2
C			ISO/R3	X
B			ISO/F2	IUF ₂
	B1	ISO/F2X	IUF ₂	IUF ₂
	A	ISO/F3	X	X
'II'	15 to 25 kg		X	X
'III'	22 to 36 kg		X	X

1. When a child seat is installed to the rear seat using ISOFIX, you must move the seat directly in front of the child seat to its fully forward and highest position. Move the back of the seat to its fully forward position. The back of the seat must be moved with the seat control switch and not the seat release strap. The front seat should also **NOT** be occupied. (Refer to 'Rear Passenger Seat Installation', page 3.32).

2. When a child seat is installed to the rear seat using ISOFIX, you must move the seat directly in front of the child seat to its fully forward and lowest position. Move the back of the seat directly in front of the child seat to an upright position.

Volante - All markets without ISOFIX Front seat.

Always follow the child seat manufacturer's instructions. Not following the child seat manufacturer's instructions when installing the child seat is dangerous.

Mass Group	Size Class	Fixture	ISOFIX Positions	
As shown on the child safety seat packaging			Driver's side Rear Outboard	Passenger's side Rear Outboard
Carry Cot	F	ISO/L1	X	X
	G	ISO/L2	X	X
'0'	Up to 10 kg	E	ISO/R1	X
'0+'	Up to 13 kg	E	ISO/R1	X
	D	ISO/R2	X	X
	C	ISO/R3	X	X
'1'	9 to 18 kg	D	ISO/R2	X
	C	ISO/R3	X	X
	B	ISO/F2	X	X
	B1	ISO/F2X	IUF ₁	IUF ₁ .
	A	ISO/F3	X	X
'II'	15 to 25 kg		X	X
'III'	22 to 36 kg		X	X

¹. When a child seat is installed to the rear seat using ISOFIX, you must move the seat directly in front of the child seat to its fully forward and lowest position. Move the back of the seat directly in front of the child seat to an upright position.

Table Key

IUF: Suitable for 'ISOFIX' forward child restraints systems of universal category approved for use in the mass group.

Suitable Child Seat: At the time of publishing the recommended ISOFIX Child Safety seats are:

Forward facing Group I (Size Class B1): Britax VERSAFIX and Britax TRIFIX.

IL: Suitable for particular ISOFIX Child Restraint Systems (CRS) given in the attached list. These ISOFIX CRS are those of the 'specific vehicle', 'restricted', or 'semi-universal' categories.

Suitable Child Seat: At the time of publishing the recommended ISOFIX Child Safety seats are:

Rear facing Group 0 & 0+ (Size Class E): Britax Baby Safe plus SHRII with ISOFIX adaptor base.

X: ISOFIX position not suitable for ISOFIX child restraint systems in this mass group or this size class.

Supplied under ECE Regulation 16.

i-Size Child Restraints.

Always follow the child seat manufacturer's instructions. Not following the child seat manufacturer's instructions when installing the child seat is dangerous.

Seating Positions

	Front Passenger	Driver's side Rear Outboard	Passenger's side Rear Outboard
i-Size Child Restraints	X	X	X

Table Key

i-U: Suitable for i-Size "universal" Child Restraint Systems forward and rearward facing.

i-UF: Suitable for forward-facing i-Size "universal" Child Restraint Systems only.

X: Seating position not suitable for i-Size "universal" Child Restraint Systems.

Supplied under ECE Regulation 16.

ISOFIX Anchors

⚠ Warning: *An unsecured child seat is dangerous. In a sudden stop or a collision it could move, causing serious injury or death to the child or other passengers. Make sure the child seat is correctly secured in place according to the manufacturer's instructions.*

⚠ Warning: *When installing the child seat, make sure that there are no seat belts or foreign objects near or around the ISOFIX anchors. If seat belts or a foreign object prevents the child seat from being securely attached to the ISOFIX anchors, the child seat could move in a sudden stop or collision causing serious injury or death to the child or other passengers.*

⚠ Warning: *Make sure that the child seat tether strap is always used when installing a child seat with ISOFIX anchors.*

Front Seats

(Optional)

The passenger seat is equipped with ISOFIX (International Standards Organisation FIX) anchors for the installation of child seats. The anchors (A) are located between the seat base and the seat back.

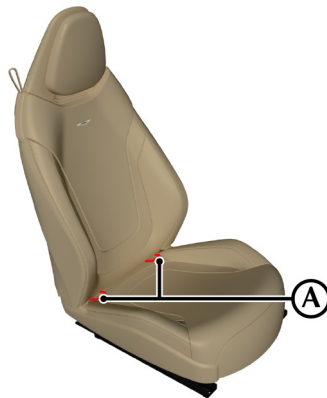

Front Passenger Seat Installation

To install a child seat to the front using ISOFIX, use the procedure that follows:

1. The passenger airbag MUST be set to OFF (Refer to 'Passenger Airbag Deactivation', page 3.20).
2. Move the passenger seat to its fully rearward and lowest position. Fully lower the front of the seat cushion.

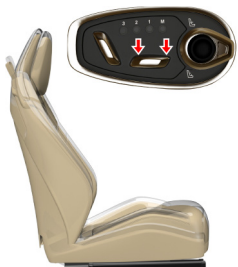
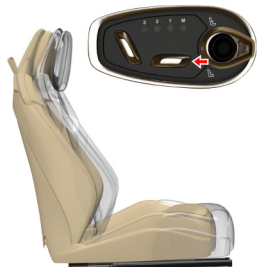

3. Fully recline the back of the seat (the front of the seat will move forward until the seat back is fully reclined).



4. Follow the child seat manufacturers instructions and install the child seat into the passenger seat.



5. Move the passenger seat backwards. The back of the passenger seat will then rise. Continue to move the seat back until the child seat is supported by the back of the passenger seat.



Rear Seats

This vehicle is equipped with ISOFIX (International Standards Organisation FIX) anchors for the installation of child seats on the rear passenger seats. The anchors are located between the seat base and the seat back. The position of the anchors is shown by two tags at the base of each rear seat.



Remove the lower seat back panel (A).

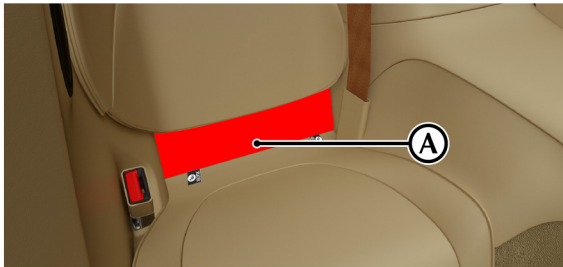

 *The seat back trim panels are left and right handed.*

Secure the child seat using the ISOFIX anchors (B), following the child seat manufacturer's instructions.

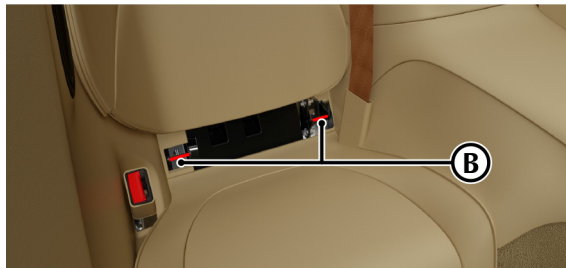

Rear Passenger Seat Installation

When a child seat is installed to the rear seat using ISOFIX, you must move the seat directly in front of the child seat depending on the size seat being installed.

For Size Class E (R1 Fixture) ISOFIX SEATS:

Coupe Only

1. Move the base of the seat directly in front of the child seat to its fully forward and lowest position.



2. Move the base of the seat to its highest position.



3. Adjust the back of the seat to its fully forward position.



For Size Class B/B1 (F2/F2X Fixture) ISOFIX SEATS:

1. Move the base of the seat directly in front of the child seat to its lowest position.



2. Move the base of the seat as far forward as possible.



3. Adjust the back of the seat to a fully vertical position.



Tether Anchors

⚠ Warning: An infant or child that is not properly restrained can be seriously injured or killed in a crash. Seat belts are designed for adults and larger children; infants and smaller children must be restrained in an approved child safety seat.

⚠ Warning: Child restraint anchorages are designed to withstand only those loads imposed by correctly installed child restraints. Under no circumstances are they to be used for adult seatbelts, harnesses or for attaching other items or equipment to the vehicle.

⚠ Warning: Always follow the child seat manufacturer's instructions. Not following the child seat manufacturer's instructions when installing the child seat is dangerous.

⚠ Warning: Make sure the child seat tether strap is free from obstructions above and below. Do not place any items on the tether strap between the child seat and the tether anchor point. Do not place tether strap over any items between the child seat and the tether anchor point.

⚠ Warning: An unsecured child seat is dangerous. In a sudden stop or a collision it could move, causing serious injury or death to the child or other passengers. Make sure the child seat is correctly secured in place according to the manufacturer's instructions.

⚠ Warning: When installing the child seat, make sure that there are no seat belts or foreign objects near or around the ISOFIX anchors. If seat belts or a foreign object prevents the child seat from being securely attached to the ISOFIX anchors, the child seat could move in a sudden stop or collision causing serious injury or death to the child or other passengers.

⚠ Warning: Make sure that the child seat tether strap is always used when installing a child seat with ISOFIX anchors.

A tether is a strap that connects the top of a child seat to a tether anchor point on the vehicle to reduce excessive movement of the child seat in the event of a collision. The purpose of a tether strap is to provide additional protection for the child seat occupant in the event of a serious impact. The tether strap is supplementary to the seat belts.

Your vehicle has a tether anchor point for the front seat¹ and both rear passenger seats².

-
1. Optional
 2. Coupe Only

Front Seats

(Optional)

The tether anchor point for the passenger seat is located at the rear base of the passenger seat. Move the seat forward to access the tether anchor point. Route the tether strap through the opening in the seat back as shown.

Engage the tether clip to the anchor point at the bottom of the passenger seat back (A) and make sure that the locking spring has fully closed to prevent accidental disengagement. Always make sure that the tether strap length is adjusted to remove any slack.

 The tether anchor adjuster (B) must go through the opening. Any adjustment must be made from the rear of the seat.

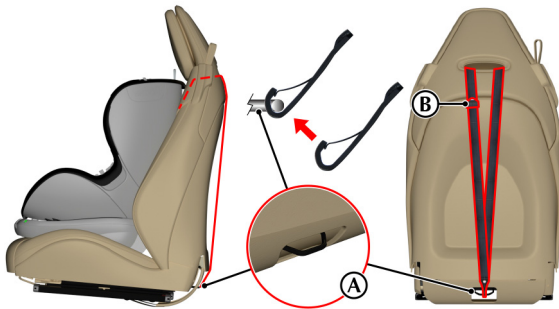

Rear Seats

(Coupe Only)

The tether anchor point for the rear passenger seat is located behind the top of the rear seats. The covers for the anchors are embossed with the tether anchor symbol.

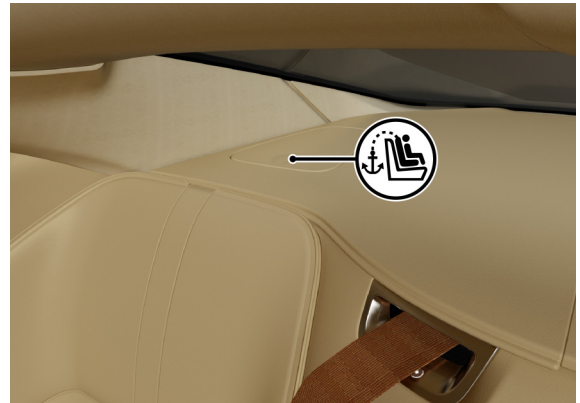

Push down on the front of the cover for the tether anchor to release the spring clip.

Remove the cover for the tether anchor (B)

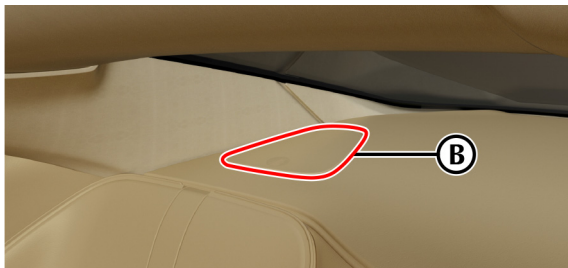

Engage the tether clip to the anchor point at the top of the parcel shelf (C) and make sure that the locking spring has fully closed to prevent accidental disengagement. Always make sure that the tether strap length is adjusted to remove any slack.

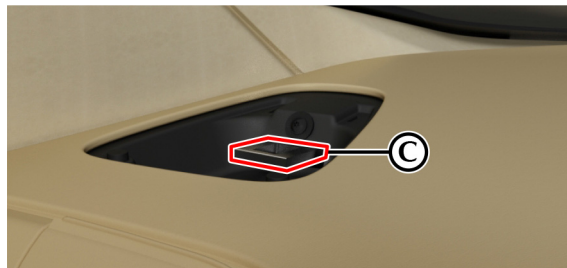

To refit the cover for the tether anchor, insert the two tabs into the slots. Push down on the front of the cover to lock.

Child Seats - Seat Belt Installation

Consult with local manufacturers of forward facing restraint and booster cushions. These manufacturers can supply you with advice on the safety of their particular child restraints and also advice on installation instructions.

Mass Group		Seating Position	
As shown on the child safety seat packaging		Front Passenger	Rear Outboard
'0'	Up to 10 kg	U ₁	X
'0+'	Up to 13 kg	U ₁	X
'I'	9 to 18 kg	U ₁	X
'II'	15 to 25 kg	U ₁	X
'III'	22 to 36 kg	U ₁	X

¹. Special positioning requirement for front passenger seat (Refer to 'Seat Position - Seat Belt Installation', page 3.38)

Table Key

U: Suitable for 'universal' category restraints approved for this mass group.

UF: Suitable for forward facing 'universal' category restraints approved for this mass group.

L: Suitable for particular child restraint systems. These restraints may be of the 'specific vehicle', 'restricted' or 'semi-universal' categories.

B: Built in restraint approved for this mass group.

X: Seat position not suitable for children in the mass group.

*****: Unsuitable for use with many child restraints due to limited space.

Supplied under ECE Regulation 16.

Seat Position - Seat Belt Installation

⚠ Warning: Always follow the child seat manufacturer's instructions for correct installation. Not following the child seat manufacturer's instructions when installing the child seat is dangerous.

⚠ Warning: Seat belt installed child restraints are designed to be secured by the lap belt and shoulder portion of the safety belt. Children could be endangered in a crash if their child restraints are not properly secured in the vehicle.

The Automatic Locking Retractor (ALR) system is designed to securely hold child seats. The ALR system temporarily locks a seat belt that is securing a child seat.

ALR Operation

Gently pull out the seat belt until fully extended. The ALR system will only engage at the maximum extension point of the seat belt. Thread the belt tongue through the child seat as per the child seat manufacturer instructions. Engage the tongue into the belt buckle.

Adjust the tongue position on the belt to make sure that the lower belt run is tight and then allow the upper run of the seat belt to fully retract until the child seat is securely held. The ALR system will be heard 'clicking' as the seat belt retracts.

When fully retracted, pull down on the upper run of the belt to check that the ALR lock has engaged.

📖 When parked on an incline, the seat belt may lock as it is withdrawn. This is not a fault. If the mechanism locks, release the seat belt tension and then pull the seat belt very gently to avoid operation of the inertia lock.

The ALR system will disengage when the seat belt is fully retracted. The seat belt may then be worn when required as a normal seat belt. Once the ALR is disengaged, the seat belt must be fully extended to re-engage the system on the next occasion that a child seat is installed.

Storage

Front Passenger Seat Installation

To install a child seat to the front seat using the seat belt, use the procedure that follows:

1. The passenger airbag **MUST** be set to OFF (Refer to 'Passenger Airbag Deactivation', page 3.20).
2. Move the passenger seat to its fully rearward and highest position. Lower the front of the seat cushion to its lowest position.
3. Recline the back of the seat as necessary.
4. Follow the child seat manufacturers instructions and install the child seat into the passenger seat.
5. Raise the seat back until the child seat is supported by the back of the passenger seat.

Rear Passenger Seat Installation

Aston Martin do not recommend a child seat is installed to the rear seats of this vehicle with a seat belt.

Door Pockets

Both front doors have door pockets.

 Do not use the door pocket to store items that could easily fall out when the door is opened, such as mobile phones or wallets.

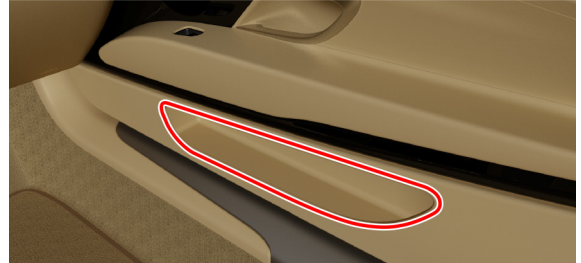

Front Trinket Tray

(Not Russian Vehicles)

There is a small trinket tray below the centre console for small item storage.

 Do not store any items in the trinket tray that may cover the hazard warning switch.

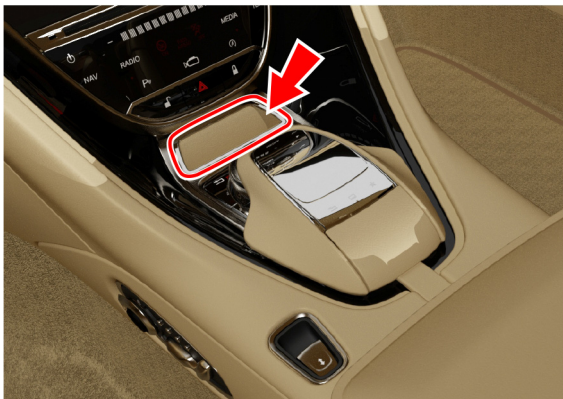

Powered Storage Box

Pull the storage box switch (A) back to move the arm rest back from position 0 (closed) to position 1 (cup holders) or position 2 (storage tray)



Position 1 (Cup Holders)

Position 1 for the powered storage box gives access to a storage tray with two cup holders. Press to open and close the cup holders.

This position also gives access to emergency ignition switch (Refer to 'Emergency Engine Start', page 2.12).



⚠ Warning: Only use the cup holder when safe to do so.

⚠ Warning: Do not place hot drinks in the cup holder while the vehicle is in motion. There is a risk of scalding if spilled.

⚠ Warning: Use soft cups only. Hard cups or objects can cause personal injury in a collision.

⚠ Caution: Do not put open top drinks containers in the cup holders. There is a risk of spillage under heavy braking or steering which can damage electrical components.

Variable Load Space

Position 2 (Storage Tray)

Position 2 for the powered storage box gives access to a large storage area, as well as an SD card port, two USB ports and a 12V accessory power socket.



(Volante Only)

This vehicle has a variable load space device installed that, when the convertible roof is raised, increases the available luggage capacity.

Operation

 *The variable load space divider can only be used with the convertible roof in its raised position.*

To open the load space push the handle up. This will provide an increase in storage space of approximately 40 litres. When the variable load space divider is in its raised position, you will not be able to lower the convertible roof.



 *A warning will be shown in the instrument cluster if the roof switch is pressed and the divider is raised.*

To lower the variable load space divider, pull the handle down.

Accessory Sockets

⚠ Warning: *Only connect accessories which are designed for use in a motor vehicle with a 12V electrical system. The electrical system could become damaged if there is more than 10A used from the accessory socket. Always read the manufacturer's instructions and make sure that you do not connect any device which can exceed the rating of the accessory socket.*

⚠ Caution: *Always use the cover for the accessory socket when not in use. Items can get into the socket and cause damage.*

There is an accessory socket located in the armrest storage box in the cabin. They may be used to power any 12 volt vehicle accessory requiring a current of less than 10A.

Ashtray and Cigar Lighter

(Optional)

⚠ Warning: *The cigar lighter will be very hot when in use. Always hold the cigar lighter by the handle and always make sure that the cigar lighter is out of reach of children. Never leave children unattended in a vehicle that has a cigar lighter.*

⚠ Warning: *Do not become distracted while driving, and always be fully aware of all driving conditions. Only use the cigar lighter when road and traffic conditions allow. Failure to avoid potentially hazardous situations could result in an accident or collision resulting in death or serious injury.*

The cigar lighter can be used in the cabin accessory socket when the ignition is on.

Push the lighter down until it clicks. The lighter will pop up when ready for use.

The ashtray installs into the cup holders.



ASTON MARTIN

Controls

Instrument Display	4.2
Centre Stack Controls	4.5
Steering Wheel Controls	4.10
Instrument Cluster Menu	4.11
Voice Control	4.14
Wiper Controls	4.15
Lighting Controls	4.15

Instrument Display

Information and Warnings

The left instrument display is used to provide warnings and important information for the running of the vehicle.



[1] ELECTRIC PARK BRAKE (EPB) MALFUNCTION:

This symbol shows if there is a fault with the electronic park brake. A warning message will also show in the right instrument cluster window. Contact your Aston Martin Dealer as soon as possible.



[2] EPB:

This symbol shows when the electric park brake is applied and goes off when the electric park brake is fully released



[3] LAMP FAILURE:

Shows when a lamp has failed. Have the system checked by an Aston Martin Dealer.



[4] SEAT BELT REMINDER:

⚠ Warning: Do not drive the vehicle if the seat belt warning symbol stays ON. Have the system checked by an Aston Martin Dealer.



This warning symbol will come on and a chime will sound for six seconds if the driver's seat belt is not fastened when the ignition is set to on. The chime will continue to operate at different vehicle speeds until the seat belt is fastened¹.

[5] OCCUPANT RESTRAINT CONTROL (ORC) WARNING LIGHT:

⚠ Warning: Do not drive the vehicle if the ORC warning symbol stays ON. Have the system checked by an Aston Martin Dealer.



At Ignition position I or II this symbol will briefly come on to do a systems test and then turn off. If it does not come on, or if it comes on and stays on, or if it comes on whilst driving, the restraint system has detected a fault.

¹. Market dependant

[6] ELECTRIC POWER ASSISTED STEERING (EPAS):



⚠ Warning: Do not drive the vehicle if the EPAS warning symbol stays ON. Have the system checked by an Aston Martin Dealer.

This symbol shows there is a fault with the EPAS system. Consult your Aston Martin Dealer as soon as possible.

[7] MALFUNCTION INDICATION LAMP:



Steady amber shows a fault in the engine management system. Continue driving only if there are no audible, visible or physical signs of degraded engine performance. Consult your Aston Martin Dealer as soon as possible.

Flashing amber shows a major fault in the engine management system. Stop immediately. Contact your Aston Martin Dealer.

[8] GASOLINE PARTICULATE FILTER (GPF) FAULT :



(V8 Engine Only)

Shows when there's a fault with the GPF (Refer to 'Gasoline Particulate Filter (GPF)', page 5.30)

[9] TYRE PRESSURE:



If this symbol stays on or comes on while driving, a tyre or tyres' air pressure is below specification

[10] ELECTRONIC STABILITY PROGRAM (ESP) :



When ESP is on this symbol will flash when the ESP is operating. If, while ESP is on, the ESP symbol stays on or it comes on whilst driving, the ESP system has detected a fault. A ESP fault message will show in the message centre. Consult your Aston Martin Dealer as soon as possible

[11] ABS:



⚠ Warning: If the ABS warning symbol stays ON, do not drive the vehicle. Have the system checked by an Aston Martin Dealer.

At Ignition position I or II this symbol will briefly come on to do a systems test and then turn off. If this symbol stays on or comes on while driving there is a fault in the ABS control circuits. Continue driving only if there are no audible, visible or physical signs of degraded brake performance. Consult your Aston Martin Dealer as soon as possible if this symbol stays on.

[12] BRAKE WARNING :



If either symbol stays on, there may be a fault with the braking system (Refer to 'Brake Warnings', page 5.19).

Instrument Cluster Overview

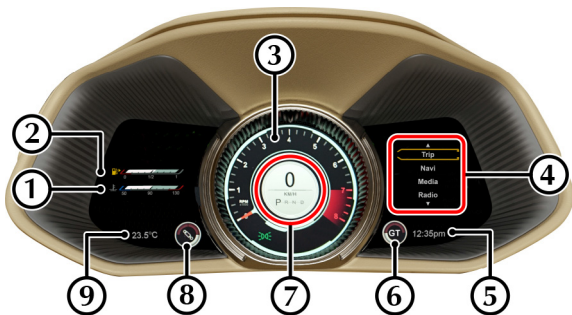

[1] ENGINE COOLANT TEMPERATURE GAUGE:

Shows the engine coolant temperature.

[2] FUEL GAUGE:

Shows how much fuel is left in the fuel tank (Refer to 'Fuel Level Warnings', page 12.53).

[3] TACHOMETER:

Shows the engine speed in revolutions per minute x 1000.

 Changes to speedometer when cruise control is set.

[4] INSTRUMENT CLUSTER MENU:

Shows an auxiliary screen for a number of vehicle functions (Refer to 'Instrument Cluster Menu', page 4.11).

 Warning messages will also appear in the right side of the instrument cluster.

[5] CLOCK:

Shows the time.

[6] DRIVE MODE SETTING:

Shows which drive mode the vehicle is in (Refer to 'Drive Modes', page 5.11).

[7] COMBINED SPEEDOMETER AND GEAR INDICATOR:

Central gauge that displays vehicle speed and the current selected gear.

[8] ADAPTIVE DAMPING SYSTEM (ADS) SETTING:

Shows which ADS mode the vehicle is in (Refer to 'Adaptive Damping', page 5.17).

[9] OUTSIDE TEMPERATURE:

Shows the outside temperature.

Centre Stack Controls

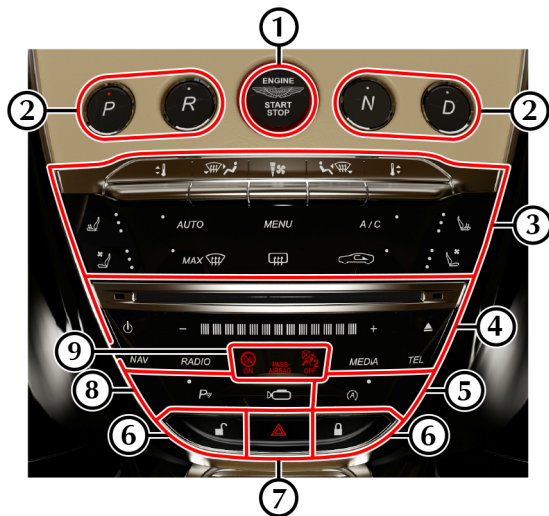

[1] ENGINE START/STOP:

Press to start or stop the engine.

[2] TRANSMISSION CONTROL BUTTONS:

P (Park), R (Reverse), N (Neutral) and D (Drive) controls.

[3] HEATING AND COOLING CONTROLS:

Controls to operate the heating and ventilation controls (Refer to 'Centre Stack Climate Controls', page 6.2).

[4] INFOTAINMENT CONTROLS:

Press to operate media controls (Refer to 'Multimedia Controls', page 8.4), hands-free phone system (Refer to 'Hands-Free Controls', page 7.2) and satellite navigation (Refer to 'Navigation Controls', page 9.3).

[5] STOP/START FUNCTION:

Press to turn stop/start function on or off (Refer to 'Stop/Start', page 5.29).

[6] MASTER LOCK SWITCHES:

Press to lock or unlock the vehicle (Refer to 'Interior Lock Switches', page 2.7).

[7] HAZARD WARNING SWITCH:

Press to set the hazard warning lamps to ON or OFF.

[8] PARK ASSIST FUNCTIONS:

Press to activate the park distance control sensors or the vehicle camera system (Refer to 'Park Assist Systems', page 5.31).

[9] PASSENGER AIRBAG STATUS (MARKET DEPENDENT):

Indicator to show if the passenger airbag is active or not.

Audible Centre Stack Feedback

To turn the audible feedback for the centre stack ON or OFF, press and hold anywhere on the volume slider. A tone will be given to confirm the change.

Control Dial

Control Dial (with optional Touch Pad)

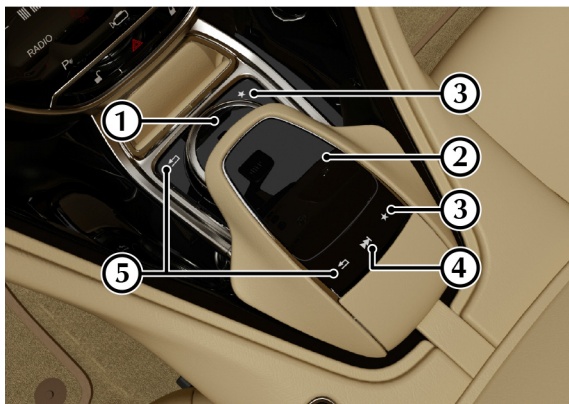

[1] CONTROL DIAL:

Use to navigate through menus in the infotainment system. Press down to confirm a selection (referred to as **ENTER** throughout this handbook).

[2] TOUCH PAD: (Optional)

Touch sensitive pad which can be used to navigate menus in the infotainment system. Press down to confirm a selection (referred to as **ENTER** throughout this manual). The touch pad can also be used for handwriting recognition.

[3] FAVOURITE:

Press to view items on your favourites list. Press and hold to add the current menu item to the favourite list.



[4] QUICK ACCESS MENU: (Touch Pad only)

Press to access the quick access menu.



[5] BACK:

Press to go back a level in the menu.



Touch Pad

(Optional)

Touch Pad ON/OFF

To activate the **TOUCH PAD** navigate to the *Vehicle Settings* menu and open the *System Settings* menu (Refer to 'System Settings', page 10.3). Select **Activate Touch Pad** to activate the **TOUCH PAD**.

Menu Navigation

The touch pad can be used for the same functions as the control dial. For example, where an instruction states to scroll left with the **CONTROL DIAL**, you can swipe left on the touch pad.



To press **ENTER** press down on the surface of the touch pad.



Quick Access Menu

To open the **Quick Access** menu, use two fingers and swipe up or press .

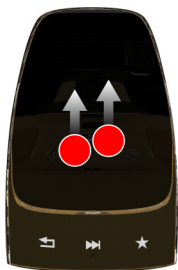

The **Quick Access** menu will then show an overview window¹ of either:

- Radio
- Media
- Telephone entry

Swipe down or press  again to close.

Rotary Controls

The touch pad can also be used to operate rotational controls. Use two fingers to rotate as shown.

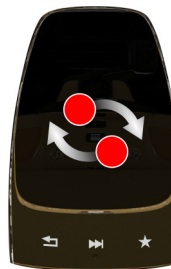

¹. The window will show the last system used.

Zoom

Pinch together to zoom out, or swipe apart to zoom in.

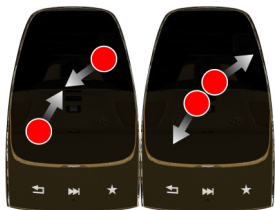

Image Pan

Press the surface of the touchpad until the crosshair is shown, and swipe in the direction you wish to pan.

Handwriting Recognition

Where text needs to be entered, such as writing a text message, characters can be 'written' using the touch pad. To begin handwriting recognition, press **ENTER** on the touch pad.

To enter characters, trace the outline on the surface of the touch pad. The infotainment system will then recognise the character, or offer suggestions if it cannot recognise characters.

Character Suggestion

The system will recognise and suggest handwritten characters. To select between character suggestion, turn the **CONTROL DIAL** and press **ENTER** on the highlighted option.

Character Delete

To delete a character, swipe to the left on the touch pad.

Add Space

To add a space character, swipe to the right on the touch pad.

Read Out handwriting Recognition ON/OFF

The handwriting recognition system can also be set to read characters out as they are written.

To set **Read Out handwriting Recognition** to ON or OFF, navigate to the **Vehicle Settings** menu and open the **System Settings** menu (Refer to 'System Settings', page 10.3). Select **Read Out handwriting Recognition** and select ON or OFF.

Steering Wheel Controls

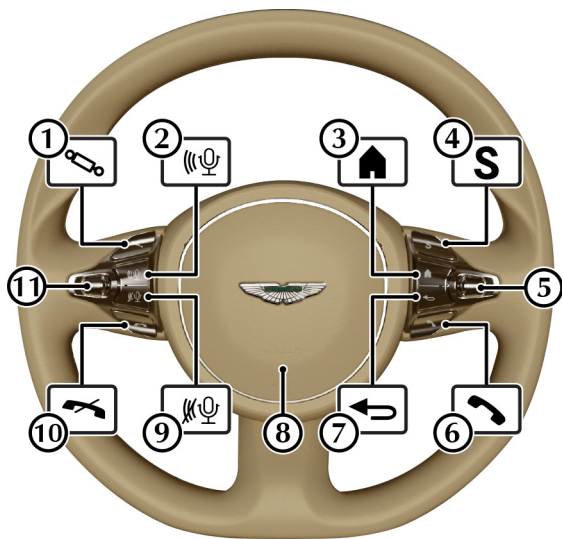

[1] ADAPTIVE DAMPING:

Press to cycle adaptive damping modes (Refer to 'Adaptive Damping', page 5.17).



[2] START VOICE CONTROL:

Press to start voice control (Refer to 'Voice Control', page 4.14).



[3] MENU HOME:

Press to open the instrument cluster menu (Refer to 'Instrument Cluster Menu', page 4.11).



[4] DRIVE MODE:

Press to cycle between drive modes (Refer to 'Drive Modes', page 5.11).



[5] MENU SCROLL:

Roll the menu scroll wheel up or down to navigate the instrument cluster menu. Press the scroll wheel button to select an item in the menu (referred to in this handbook as **OK**).

[6] CALL:

Press to answer an incoming call (Refer to 'Calls', page 7.5).



Instrument Cluster Menu

[7] MENU BACK:

Press to go back one level in the instrument cluster menu.



[8] HORN:

Push to sound the vehicle horn.



[9] END VOICE CONTROL:

End voice control.





[10] END CALL:

Press to end a call or reject an incoming call.



[11] VOLUME DIAL: Roll the volume scroll wheel up or down to increase or decrease volume for the audio system, or volume during a phone call. Press the scroll wheel button to set sound to ON or OFF. Setting sound off will also pause media where applicable.

 Press and hold the scroll wheel button during traffic announcements to set traffic announcements to off.



 Navigation announcements will still be heard if the sound (audio or call) is set to off. Press and hold the volume scroll button during a navigation announcement to mute navigation prompts.



The instrument cluster includes a secondary infotainment system menu. This menu includes settings for the instrument cluster such as trip computer and units as well as audio and navigation overview screens.

The instrument cluster menu options are:

- Trip
- Navi
- Radio
- Media
- Telephone
- Service
- Settings

Use the  button (A) to open the menu home screen. Scroll through the available options with the menu scroll wheel (B) and select an item by pressing the scroll wheel button (referred to in this handbook as the **OK** button). Press the  to go back a menu level.

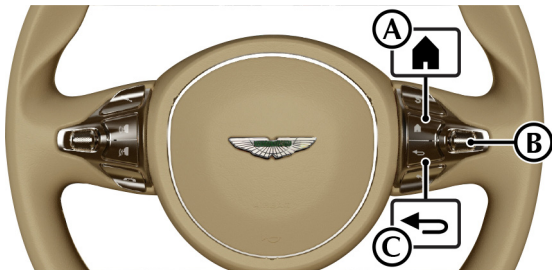

Trip

The trip menu will show journey information about the vehicle. From the trip menu select:

- **From Start:**
Distance travelled, journey time, average fuel consumption and average speed are shown from when the ignition was turned ON.
- **From Reset:**
Distance travelled, journey time, average fuel consumption and average speed are shown from when the trip menu was last reset.
- **Odometer:**
Distance since last trip menu reset and total vehicle distance are shown.
- **Range/Consumption:**
Range till empty and fuel consumption are shown.

Trip Menu Reset

Press **OK** when the trip menu shows the **From Start**, **From Reset** or **Odometer**₁ to open the **Reset** window. Press **OK** to confirm reset.

1. Trip Menu Reset does not reset the total vehicle mileage.

Navigation

Shows the next turn if a route has been set. If no route has been set, shows direction of travel.

Radio

Shows the selected radio station. Scroll or press **OK** to open the radio station list. Use the scroll wheel to select a station and press **OK** to confirm.

Media

Shows the selected media track.

Change Track

Press to open the media track list. Use the scroll wheel to select a track.

Change Media Source

Press **OK** to open the media sources list. Use the scroll wheel to select a media source.

Telephone

A mobile device must be paired to the infotainment before this function can be used (Refer to 'Pairing a Device', page 7.3).

Shows current network provider. Scroll or press **OK** to open the contact list. Press **OK** or  to begin a call.

When a call is in progress, the call status is shown.

Service

The service menu shows information on vehicle. Select from:

- **Messages:**
Show any stored warning messages.
- **Tyres Pressure:**
Opens the Tyre Pressure Monitoring System Menu (Refer to 'Tyre Pressure Monitoring System (TPMS)', page 5.26)
- **Service Reminder:**
Shows how long until the next service is required.

Settings

The settings menu changes settings related to the instrument vehicle and driver functions. Select from:

- **Assistance:**
 - **ESP**
Opens the Electronic Stability Program (ESP) menu to set to ON, Track or OFF (Refer to 'Electronic Stability Program (ESP)', page 5.23).
 - **Blind Spot Assist**
Select to set the Blind Spot Assist to ON or OFF (Refer to 'Blind Spot Assist', page 5.14).
- **Instrument Cluster:**
 - **Distance Units**
Select between Miles or Kilometers.
 - **Consumption Units**
Select between MPG or L/100 Km.
- **Factory settings:**
Reset all settings back to factory settings.

Voice Control

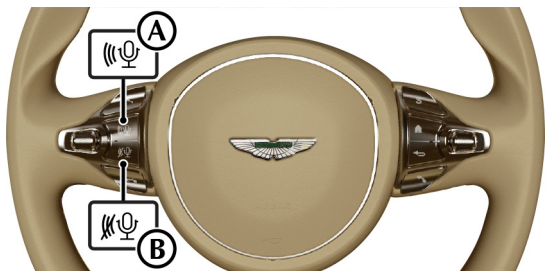

Individualisation

Individualisation is a function that can help refine the Voice Control system to your own voice. To begin individualisation, navigate to **Vehicle** on the main menu and select **System Settings** on the lower information bar. Select **Voice Control** and select **Individualisation**. Press **ENTER** when the pop up window is shown to begin.

Commands can be selected in the infotainment system using voice commands. To begin voice control, press the Voice Control

ON  (A) and say a command.

For example:

- "Enter Destination" will give a list of options to enter a destination in the navigation system.
- "Next Artist" will play the next available artist in the media system if more than one artist is available.

If a command is not available, or the system did not correctly hear the command, a list of available command will be heard.

To cancel voice control press the Voice Control OFF  (B).

Wiper Controls

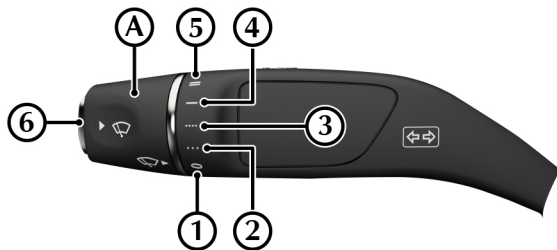

Rotate the wiper speed selector (A) to select a wiper speed.

[1] : Windscreen wipers OFF

[2] : Intermittent wipe (low rain sensor sensitivity)

[3] : Intermittent wipe (high rain sensor sensitivity)

[4] : Continuous wipe (slow)

[5] : Continuous wipe (fast)

[6] : Press for single wipe operation. Press and hold further to operate the front windscreen washers.

 At vehicle speeds above 240 km/h (150 mph) the wipers may automatically move to a high park position to reduce aerodynamic load. The wipers will function as normal and return to their normal park position when vehicle speed drops below 4 km/h (3 mph).

⚠ Caution: Set the ignition to on and wipers to off when in a car wash or if the vehicle is being pressure washed. Ignition on will make sure the wiper arms are locked into the park position and will help prevent damage to the wiper arms.

Lighting Controls

Exterior lamps

Master Lamp Switch

Turn the dial to the required light setting. Press the fog lamp button to operate the rear fog lamp.

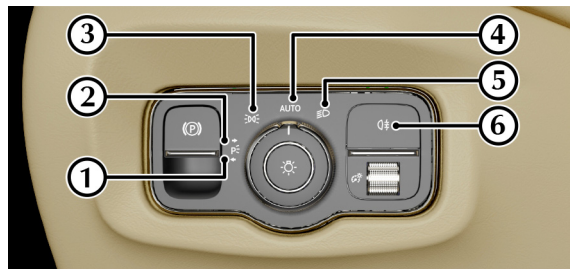

[1] : Left side park lamp

[2] : Right side park lamp

[3] : Side lamps (including number plate lamps)

[4] : Automatic headlamp mode

[5] : Dipped beam headlamps

[6] : Rear foglamp₁

Exterior lamps (except the side lamps/parking lamps) switch off automatically if you turn the ignition off.

1. The rear fog lamp will only operate with the headlamps set dipped beam (4) or automatic (5).

Automatic Headlamp Mode

If ambient light fades, headlamps, rear and registration plate lamps will switch ON automatically. If ambient light then increases, headlamps, rear and registration plate lamps will automatically go OFF. Automatic lamps are market specific.

 The automatic headlamp function features an internal timer that starts when the lamps are turned on. This prevents the lamps from rapidly changing between on and off if situations where ambient light can rapidly change, such as driving between buildings. The headlamps may show a small delay between when a suitable amount of ambient light is detected, and the lamps turning off.

Cornering Lamps

The cornering lamp function turns on additional LEDs in the headlamps based on the steering angle of the front wheels. This will help illuminate the direction of travel and assist in recognising pedestrians, cyclists and animals earlier.

Stalk Controls

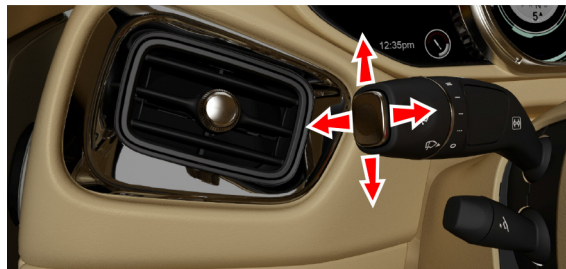

Main Beam

Push the stalk away to turn on main beam headlamps. Pull the stalk back to the initial position to return to dipped beam headlamps.

Flash Headlamps

Pull the stalk to flash the main beam headlamps.

Direction Indicators

To briefly indicate, press up to indicate a right turn and down for a left turn. Press until the switch latches to hold the selected indicator on. The stalk will return to the centre position on completion of a manoeuvre.

Hazard lamps

 The hazard warning lamps will continue to operate if the ignition is switched off.



Press the hazard warning lamp button (A) to set the hazard warning lamps to on. All direction indicator signals will flash. Press the button again to set the hazard warning lamps off.

If you operate a direction indicator from the indicator stalk, only the selected direction indicators will operate. Once cancelled, the hazard warning lamps will resume operation.

Interior Lamps

Instrument Illumination



During the daylight hours the level of instrument brightness defaults to maximum brightness. During the twilight and night time hours, a twilight sensor located at the top of the windscreen automatically reduces the level of brightness to a preset level.

 If the twilight sensor is covered then the level of brightness will stay low as if in night time mode. For example, when parked in a garage.

The level of brightness can be reduced by using the illumination dial (A).

Reading Lamps

Two reading lamps are located in the front header trim. To operate the lamps (on or off) touch the reading lamp bezel (A). Unless set to off or on they will continue to operate up to six minutes after the ignition is set to off.



An additional rear reading lamp can be found in the centre of the rear header.



ASTON MARTIN

Driving

Driving Techniques	5.2
How To Start The Engine.....	5.4
Transmission Controls.....	5.5
Cruise Control with Speed Limiter	5.8
Drive Modes	5.11
Blind Spot Assist	5.14
Adaptive Damping	5.17
Brakes	5.18
Electronic Stability Program (ESP).....	5.23
Tyre Pressure Monitoring System (TPMS)	5.26
Eco Driving Features.....	5.28
Gasoline Particulate Filter (GPF)	5.30
Park Assist Systems	5.31
Emergency Call System.....	5.39

Driving Techniques

Procedures for driving this vehicle may be unfamiliar to many new owners. To make sure that you have a safe and enjoyable entry into this new phase of Aston Martin motoring, please take time to safely acquire the necessary new driving skills. Practice in safe, lower speed conditions before investigating the high performance potential of the vehicle.

Driving behaviour, such as avoiding aggressive driving, travelling at lower speeds, correctly inflating tyres, reducing periods of idling and not carrying excessive weight, will improve fuel consumption and reduce CO2 emissions.

Performance Driving Courses

Performance driving courses are available to enable you to fully understand the control functions of your vehicle and also the basic principles of performance driving. Contact your Aston Martin Dealer for further information.

Running-In

This vehicle is fully hot tested during manufacture and no special running-in procedures are necessary. Nevertheless it is recommended to limit engine loads (e.g. by accelerating gently and by using lower gears on steep hills or when negotiating tight turns) during the first 1500 km/900miles.

Track Days

Before using this vehicle on track days contact your Aston Martin Dealer for vehicle set up, service parts and recommendations.

Wet Conditions

When driving in wet conditions, water can build up under your tyres so that they ride on a layer of water. This is called aquaplaning or hydroplaning. When this happens, you have little or no control. Aquaplaning is more prone to happening at higher road speeds if there is a lot of water on the road and particularly if the tyres are also under inflated or approaching minimum tread depth.

It is important to take bends or curves at a safe, reasonable speed, particularly when driving on wet or slippery road surfaces.

Slow down when it is raining.

Driving Through Deep Water

If in any doubt whether to drive through deep water, always take the side of caution to avoid potentially costly damage to the vehicle's engine or other essential systems.

⚠ Caution: Never drive in water deeper than the lower edge of the front bumper. Water can be splashed up into the engine air intakes located in the front upper grille and cause extensive damage to the engine or the vehicle may stall. Always proceed with extreme caution, especially when the depth is not known.

When driving through water, traction or brake capability may be limited. Once through the water, always dry the brakes by driving slowly while applying light pressure on the brake pedal.

 Waves caused by other vehicles or natural causes can also splash water in the engine air intakes.

Tyre Skip At Low Speed

In certain conditions, the front tyres may 'skip' at low speeds with summer tyres installed when a high level of steering lock is applied. This is a characteristic of the vehicle and does not affect the safety or performance of the vehicle.

How To Start The Engine

⚠ Warning: *The engine can be started by any person in the vehicle if the brake pedal is pressed down. Care should be taken that the vehicle is not left unattended with the key present and occupants such as young children inside.*

⚠ Caution: *In extreme low temperatures (-20°C and below) do not run the engine above 4000 rpm, while at standstill or when moving off, until the coolant temperature gauge reaches normal operating temperature. If you do, there is a risk of damage to the engine and transmission.*

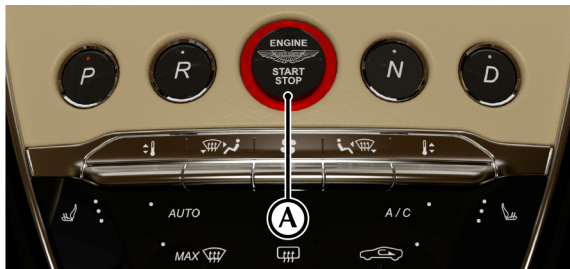

⚠ Caution: *Make sure the park brake is applied and the transmission is in PARK (P).*

This will prevent the vehicle from moving once the engine is started.

To start the engine, fully press the brake pedal down and press **START/STOP** (A). The button bezel will flash red once and the steering lock will release.

Once the engine begins to crank, release **START/STOP**.

Stopping The Engine

Press **START/STOP** to stop the engine.

Quiet Start

Push and hold **START/STOP** for 3 seconds to use the Quiet Start feature. The button bezel will flash red twice to confirm. In Quiet Start, the volume of the exhaust note is reduced on engine start.

Transmission Controls

The automatic transmission has two main driver modes:

- **Automatic Mode:**
Transmission is controlled automatically without driver input.
- **Touchtronic Mode:**
Gear changes can be controlled with the gearshift paddles behind the steering wheel.

Automatic Mode

In *Automatic* mode, gearshifts are made using the Park, Reverse, Neutral and Drive (PRND) buttons mounted on the centre stack. While driving forward, gearshifts are made automatically according to various driving parameters, i.e. road speed, current selected gear and accelerator demands. When the vehicle is stationary, the transmission will select first gear, ready to move off immediately when the accelerator is pressed.

While in *Automatic* mode, move to *Touchtronic* mode at any time by pulling back on either the upshift or downshift paddles, mounted behind the steering wheel. As a paddle is pulled back a gearshift will occur, which will be an upshift or downshift according to which paddle is pulled.

Kick-Down

In *Automatic* mode, kick-down is used in circumstances where rapid acceleration is required, i.e. when overtaking. Kick-down operates when the accelerator pedal is quickly and fully depressed, causing the transmission to change down to the lowest gear possible to achieve maximum acceleration. The gear engaged depends on the road speed at the time of kick-down.

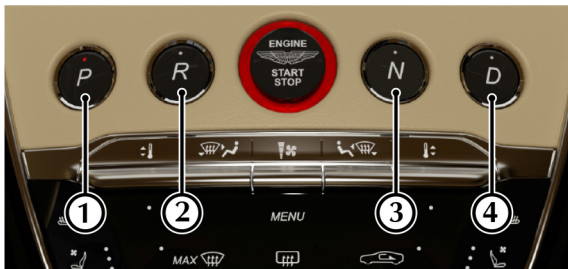

[1] P (PARK): Press and release to select Park when the vehicle is stationary. The transmission will mechanically lock.

⚠ Caution: *Always make sure that the park brake is ON. This will help to make sure the vehicle will not roll.*

📖 *It is not possible to select Park above 2 km/h.*

[2] R (REVERSE): When stationary and with the footbrake applied, press and release to select Reverse. When reverse is selected, the infotainment screen will change to show the reverse camera display.

[3] N (NEUTRAL): Press and release to select Neutral.

⚠ Caution: *Do not change from Park or Neutral into Drive or Reverse at high engine speed. Doing so can damage the transmission or the engine.*

[4] D (DRIVE): When stationary and with the footbrake applied, press and release to select forward gears.

Vehicle Rocking Motion

If the vehicle speed is less than 4 km/h, reverse may be selected from drive, without pressing the brake pedal, to create a vehicle 'rocking' motion i.e. to enable vehicle movement out of mud, snow, etc. If 4 km/h is exceeded then the transmission will automatically select Neutral.

Touchtronic Mode

In *Touchtronic* mode, gears are selected by using the paddles located behind the steering wheel. Reverse and Park are selected by using the PRND buttons.

While in *Touchtronic* mode, move to *Automatic* mode at any time by pressing the D (Drive) button, or by pulling and holding the upshift (+) paddle until Drive is selected.

Select Neutral by pulling on both the upshift and downshift paddles at the same time.

 *Neutral can also be selected by pressing the N (Neutral) button.*

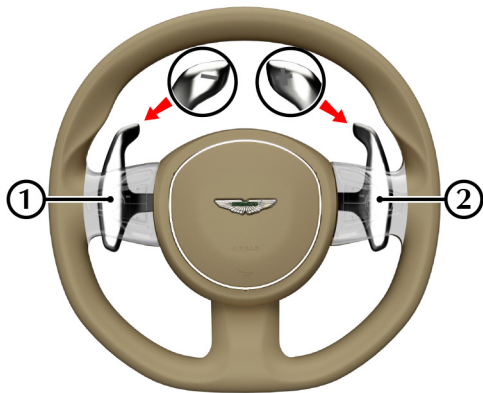

P (Park) and R (Reverse) are selected with the PRND buttons.

[1] : Downshift Paddle

[2] : Upshift Paddle

Pull back on either the upshift (+) or downshift (-) paddle to enter *Touchtronic* mode. As the vehicle speed increases and decreases, make upshifts and downshifts by pulling and releasing the upshift or downshift paddle.

If no gearshift has been requested by pulling back on a paddle, upshifts will occur automatically depending on the drive mode¹ as the engine speed rises or lowers to its maximum or minimum operating limits.

If driving in a high gear, pull and hold the downshift paddle to select the lowest available gear. For example, if in sixth gear then second gear is selected.

When stationary, select Neutral by pulling back on both paddles at the same time. When selecting Neutral from Park, the brake pedal must be depressed.

When in touchtronic mode, pull back on the upshift paddle for more than two seconds to move to automatic mode.

The instrument cluster shows the actual gear currently selected R, D1, D2, etc and the target gear when a gearshift is in progress.

¹. GT Mode: All Gears.

Sport and Sport+: 1st to 2nd gear.

Cruise Control with Speed Limiter

Gear Shift Indicator

The centre message window shows the current gear selected with an up arrow to indicate when a gear change should take place to obtain better fuel economy. For example, when in third gear and a higher gear needs selecting 3 ^ is shown in the centre message window.

⚠ Warning: Only use cruise control or the variable speed limiter if road and traffic conditions are appropriate for maintaining a steady speed for a prolonged period. If you do not, this may cause an accident or collision resulting in death or serious injury.

⚠ Warning: Both cruise control and the variable speed limiter are aids and cannot take into account road, weather or traffic conditions. You are responsible for vehicle speed, braking in good time, controlling the distance to any vehicle(s) in front and for staying in the correct lane.

The cruise control system should not be used when:

- road and traffic conditions do not allow you to maintain a constant speed, e.g. in heavy traffic or on winding roads.
- driving on smooth or slippery roads. Braking or accelerating can cause the drive wheels to lose traction and the vehicle could then skid.
- visibility is poor, such as fog, heavy rain or snow.

Selecting Cruise Control or Speed Limiter

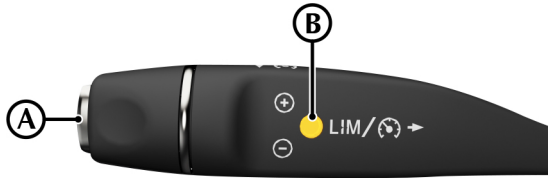

Press the selector button (A) to switch between cruise control and variable speed limiter function. If the LIM indicator light (B) is set to ON, variable speed limiter is active.

Operation

Cruise control can be used to maintain a selected vehicle speed without having to use the accelerator.

The variable speed limiter brakes automatically so that you do not exceed the set speed. This feature is an aid only and cannot take into account road, weather or traffic conditions. You are responsible for vehicle speed, as well braking in good time, the distance to any vehicle(s) in front and for staying in the lane.

 Both cruise control and variable speed limiter only operate at speeds above 30 km/h.



 When cruise control or variable speed limiter is active, the tachometer in the instrument cluster changes to vehicle speed.

Setting A Speed

Lightly push the cruise control lever up to increase speed, or down to decrease speed in 1 km/h (1 mph) increments. A hard press in either direction will increase in 10 km/h (5mph) increments. Pushing the cruise control lever in either direction will set a new vehicle speed in the cruise control or new vehicle speed limit.

 *Cruise control will automatically disengage when the brake pedal is pressed or when the vehicle speed falls below 30 km/h (18 mph).*

 *The variable speed limiter is not deactivated when the brake pedal is pressed.*

Resuming the Set Speed

 **Warning:** *Set speed should only be resumed if the driver is aware of the set speed and intends to return to it.*

 *Cruise control will not resume at speeds below 30 km/h.*

Pull the cruise lever towards you to resume the set cruise control speed or speed limit.

If the vehicle is accelerated above the set speed, then the set cruise speed will be resumed when the accelerator pedal is released.

If the cruise control is deactivated, or the brake pedal is pressed, cruise control will disengage but the set speed memory will be kept. Pull the cruise control lever again and the vehicle will return to the set speed.

Drive Modes

Deactivating Cruise Control

Push the cruise control lever away from you to deactivate cruise control or speed limiter.

The cruise control and speed limiter set speeds will also be cleared when the ignition is set to off.

Cruise control will automatically deactivate when:

- The clutch pedal is pressed down for more than 6 seconds (manual transmission).
- The brake pedal is pressed.
- The park brake is applied.
- Vehicle speed drops below 30 km/h (18 mph).
- Neutral, Park or Reverse gear positions are selected (automatic transmission).
- The traction control system is activated.
- The variable speed limiter system is activated (LIM indicator light is on).
- A fault occurs in the cruise control system. the cruise control system will not operate until the fault is cleared.

Vehicle driving characteristics, such as gear changes and throttle response, can be changed by selecting different drive modes.

Three drive modes are available. Press the **S** button (A) to cycle between:

- GT
- Sport
- Sport+



The selected mode will be shown in the right instrument cluster window (B).

 Drive modes operate independently of Electronic Stability Program (ESP) and Adaptive Damping System (ADS) modes.



GT Mode

GT mode provides a default comfort setting, best suited to casual and motorway driving.

The transmission is set to use a base transmission calibration when in *Drive* to suit a touring style of driving. In *Touchtronic* mode, gear shifts take place automatically if engine speed exceeds 6800 rpm.

*Cylinder Deactivation*₁ (Refer to 'Cylinder Deactivation', page 5.28) and *Stop/Start* (Refer to 'Stop/Start', page 5.29) functions are available to improve fuel economy.



Sport Mode

Sport mode uses a more aggressive transmission calibration, but still with a level of comfort when changing gear.

The transmission now uses a more aggressive calibration when in *Drive*, yet still comfortable enough to be used for general driving. In *Touchtronic* mode, the transmission will only automatically make a change from 1st into 2nd gear.

Throttle response is also increased with a more sporting throttle pedal calibration.

The exhaust bypass valves operate at lower engine speed to give a sense of increase driver involvement.

Cylinder Deactivation is disabled in *Sport* mode, but engine *Stop/Start* is still available to use.

The *Stop/Start* (Refer to 'Stop/Start', page 5.29) function is available to improve fuel economy.



Sport+ Mode

Sport+ mode further increases transmission and engine response.



The transmission is now set to use an even more aggressive calibration than used in *Sport*, with the exhaust bypass valves also revised to open at lower engine loads and speed. Gearshifts are not done automatically from 2nd gear onwards in *Touchtronic* mode, allowing the driver to hold on to individual gears.

Both *Cylinder Deactivation*₁ and engine *Stop/Start* functions are disabled in *Sport+* mode

Sport+ mode also adds a transmission temperature gauge (C) to the left instrument cluster window.

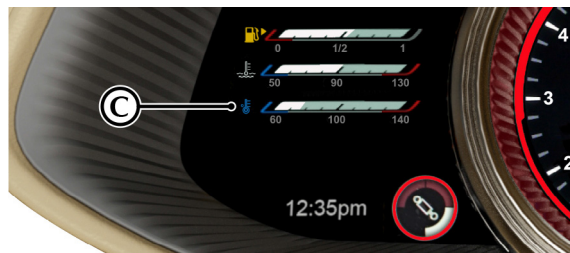

¹. V12 Engine Only

Blind Spot Assist

⚠ Warning: Blind Spot Assist is for visual aid only and does not replace the need for driver awareness. It is the driver's responsibility to be aware of their surroundings and make sure it is safe to complete a lane change. Always make sure that there is a suitable distance to the side of your vehicle for other road users and obstacles.

⚠ Warning: The Blind Spot Assist system can not react to vehicles which approach and overtake you at a greatly different speed. In these situations, the Blind Spot Assist system cannot provide warning to drivers. Always pay attention to the road traffic around you.

Blind Spot Assist is used to help a driver know if a vehicle is in their blind spot so that a lane change action can be safely completed.

The BSA system uses two rear-facing radar units to monitor the area up to 3.5 m (12 ft) behind your vehicle and 3 m (10 ft) directly next to your vehicle.

If a vehicle is detected at speeds above approximately 30 km/h (18 mph) and enters the monitoring range directly next to your vehicle, the warning lamp in the exterior mirror will illuminate amber. If a vehicle is detected close to your vehicle in the lateral monitoring range and you switch on the turn signal indicator in that direction the amber warning lamp in the outside mirror will flash. If the turn signal indicator remains on, all other detected vehicles are indicated only by the flashing of the amber warning lamp. If you overtake a vehicle quickly, no warning is given.

 *The system can monitor vehicles when driving around curved roads.*

Operation Conditions

For the Blind Spot Assist system to operate the below conditions must be met:

- Transmission must be in D (Drive).
- The vehicle must be moving at more than 30 km/h (18 mph).
- Vehicles in the blind spot area must be travelling at speeds of:
 - more than 5 km/h (3 mph).
 - between 5 km/h (3 mph) slower and 35 km/h (22 mph) faster than your vehicle.
- The minimum width for a vehicle to be detected is 0.7 m wide (a motorcycle for example).

System Limitations

The BSA system can be limited in its operation in the below situations:

- The sensors are dirty or obstructed such as snow or mud on the bumpers.
- Poor visibility weather conditions (snow, fog, heavy rain etc).
- Warnings may be incorrectly displayed near to crash barriers or long solid barriers.
- Warnings can be interrupted when driving alongside long vehicles such as vehicles with long trailers.

System activation

The BSA system can be activated or deactivated in the instrument cluster menu (Refer to 'Instrument Cluster Menu', page 4.11).

Blind Spot Warnings

Stage One Warning

When the BSA system detects a vehicle in the driver's blind spot area, an amber LED triangle (A) will be shown in the top outer corner of the door mirror.



Stage Two Warning

The BSA system will be set to stage two if:

- A vehicle is detected in the blind spot area.
- The indicator is used to signal movement into that lane.

When this happens, the below actions will take place.

- The amber triangle in the door mirror will flash.
- A warning symbol will show in the instrument cluster (changes for direction of lane change).



Fault Conditions

In the unlikely event of a fault in the BSA system, a warning message will also show in the instrument cluster. Contact your Aston Martin Dealer.

Radio Equipment Directive

Hereby, Robert Bosch GmbH declares that the radio equipment type MRR1Rear is in compliance with Directive 2014/53/EU. The full text of the EU declaration of conformity is available at the following internet address: <http://eu-doc.bosch.com>

Frequency band 76-77 GHz.

Maximum Output Power <24.7 dBm.

Adaptive Damping

The Adaptive Damping System (ADS) uses sensors to continuously monitor vehicle body movement and driver inputs, such as steering, braking and throttle input. The system then adjusts the suspension damping characteristics to suit the conditions.

Three adaptive damping modes are available. Press the **DAMPING** button (A) to cycle between:

- GT (Default setting)
- Sport
- Sport+



 ADS will be set to GT mode at each ignition on.

 ADS modes operate independently of Electronic Stability Program (ESP) and drive modes.

The selected adaptive damping mode is shown in the left instrument cluster window (B). The ADS mode will also be briefly shown in the right instrument cluster window when the ignition is set to ON or when the ADS mode is changed.

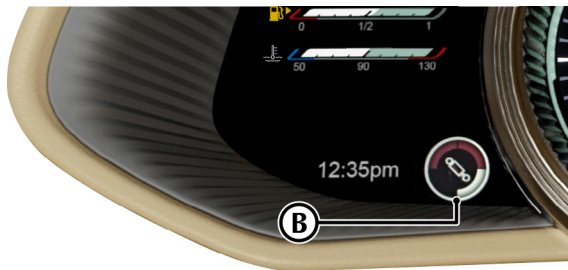

GT

GT mode provides a default comfort setting for the suspension, suitable for everyday use.



Sport

Sport mode changes the damping characteristics with increased body control and a firmer ride. Steering weight is also increased to enhance steering response and feedback.



Sport+

Sport+ mode further increase the stiffness of the damping, more suitable for track focused driving.



Brakes

Footbrake

The footbrake uses a vacuum boosted, dual (diagonal split) circuit hydraulic system with Anti-lock Brake System (ABS).

⚠ Warning: *In the event of a brake failure, bring the vehicle to a stop as soon as it is safe to do so. Do not continue to drive the vehicle. To do so could result in an accident or collision resulting in death or serious injury.*

⚠ Warning: *Greater care may be necessary after a long drive over salted or gritted roads or if driving in heavy rain, through water or a vehicle wash. Brake action may be delayed and increased braking pressure may be required.*

⚠ Warning: *Aston Martin recommend that the brake fluid is replaced before and after the vehicle is used for high performance driving such as a track day. Failure to do so may result in greatly reduced brake performance. Contact your Aston Martin Dealer.*

⚠ If vacuum boost or a brake circuit fails, the footbrake will still operate, but with greater pedal pressure, increased pedal travel and longer stopping distances. Contact your Aston Martin Dealer.

 (V12 Engine Only)

Vacuum boost is only available with ignition at position II or while the engine is running.

 The high performance brake system used on this vehicle is designed to provide optimal braking under all operating conditions. However, an inherent characteristic of this braking system is some brake noise. Certain combinations of speed, braking forces and ambient conditions may also cause the brakes to squeal.

Brake Throttle Override

If the throttle and brake pedals are both pressed at the same time for over 3 seconds, the engine will restrict available torque. Normal functionality will return when the throttle pedal is pressed without the brake pedal.

Brake Warnings

 Warning: If either brake warning symbol comes ON, you should immediately be prepared for increased stopping distances or partial failure of the braking system.

If the brake warning symbol  comes ON while driving, the brake system has a fault and braking performance may be affected.

If the brake warning symbol  comes ON while driving:

- The brake booster system has a fault and braking performance may be affected.
- The brake fluid level is insufficient.

 A message will also show in the instrument cluster window with further information.

Stop as soon as possible in a safe and convenient place. Apply the footbrake and make sure that the park brake is fully released. If the warning symbol stays ON, do not drive the vehicle. It is essential that the brake system is checked immediately. Contact the nearest Aston Martin Dealer.

ABS Warnings

 Warning: If the ABS warning symbol comes ON, you should be aware that wheels could lock during extreme braking or when braking on slippery surfaces.



ABS is monitored for correct operation while the ignition is ON.

If a fault is detected, the  will come ON and the ABS will be either partly or fully OFF. Normal braking will continue to function without ABS.

In the event of an ABS fault, have the braking and ABS systems checked immediately by an Aston Martin Dealer.

ABS and Electronic Stability Program (ESP) Warnings

 Warning: If the ABS and ESP warning symbols come ON, you should be aware that wheels could lock during extreme braking or when braking on slippery surfaces. Steering performance can also function differently and there is increased risk of skidding and/or accident.

If ,  and  come ON while driving both ABS and ESP have a fault. The brake system will continue to operate, but without assistance from either ABS or ESP. Both front and rear wheels may lock under heavy braking which can result in longer braking distances in an emergency stop.

 A message will also show in the right instrument cluster window with further information.

Drive on carefully and have the braking and ABS systems checked immediately by an Aston Martin Dealer.

Anti-Lock Braking System

The Anti-lock Braking System (ABS) helps prevent the road wheels from locking and causing the vehicle to skid during emergency braking. This also assists the driver in maintaining steering and directional stability.

If the braking force exceeds tyre grip in an emergency braking situation, the ABS operates to prevent the wheels locking. A pulsating effect is felt through the brake pedal when this happens. This is a normal effect of the ABS operating.

Two-Stage ABS

The ABS features two levels of calibration that change depending on Electronic Stability Program (ESP) setting (Refer to 'ESP Modes', page 5.23).

Safety

It is always the driver's responsibility to drive safely with regard to driving conditions and according to the law. The fact that a vehicle is equipped with ABS must never let the driver be tempted into taking risks which could affect his or her safety or that of other road users.

The addition of ABS cannot overcome the consequences of trying to stop in too short a distance, cornering at too high a speed, or aquaplaning (where the tyres are prevented from contacting the road surface by a layer of water).

The driver should always take road conditions into account. A slippery road surface always requires more braking distance for a given speed, even with ABS. Stopping distances can increase with ABS compared to locked wheels on slushy snow, gravel, sand or certain heavily corrugated or ridged warning sections of road surfaces.

If any braking system malfunctions, have the braking and ABS systems checked immediately by your Aston Martin Dealer.

Brake Pad Conditioning

⚠ Warning: For track use or high speed driving, new brake pads must be correctly conditioned. Failure to correctly condition the pads may result in greatly reduced brake performance. Contact your Aston Martin Dealer for further information.

When new brake pads are installed the brake discs and pads need to be conditioned. During this time, brake performance will be reduced.

Avoid excessive braking, such as hard stops from high speed and steep descents, for the first few hundred miles or kilometres¹ after new brake pads are installed.

¹. Distances can vary depending on driving conditions and frequency of brake use

Park Brake

Park Brake Operation

⚠ Warning: If the brake system warning symbol is ON or flashing, do not rely on the park brake to hold the vehicle stationary. Contact your Aston Martin Dealer.

When the vehicle is stationary, push the park brake switch (A) in and release. The  warning symbol in the instrument cluster will come on when the park brake is applied. The stop lamps will not come ON.



 The park brake operates on the rear wheels of the vehicle.

⚠ Caution: Secure parking of the vehicle is dependent on being on a hard and stable surface. The rear wheels must be on a suitable surface to prevent vehicle movement.

The ignition control must be on to release the park brake. First apply pressure to the foot brake then pull on the park brake switch and release. The  symbol will go off to show the park brake has been released.

Drive Away Release

⚠ Warning: Do not exit the vehicle with the engine operating and the transmission in D (Drive) or R (Reverse). Always select P (Park) before exiting the vehicle. If the transmission is left in D (Drive) or R (Reverse), the vehicle can overcome the park brake and start to move.

With the park brake applied, select a forward or reverse gear and press the throttle pedal. The park brake will release as the vehicle moves forwards or backwards.

The park brake will not release when moving from stationary if a vehicle door is open. In this case the park brake must be released with the park brake switch.

Park Brake Operation While Moving

⚠ Warning: Repeated use of the park brake to slow the vehicle, or driving the vehicle with the park brake applied can cause serious damage to the brake system.

In an emergency, push and hold the park brake switch to reduce speed. The  symbol will come on, a warning sound will be heard and CAUTION PARK BRAKE APPLIED will be shown in the right instrument cluster window.

Release the switch to cancel the park brake application whilst the vehicle is moving. The park brake will only apply as normal once the vehicle has stopped movement.

Park Brake Faults

Low Battery Voltage

If the battery voltage is too low, the park brake cannot be put on or off. Connect an auxiliary battery if the battery voltage is too low.

System Faults

If a fault in the system is detected, PARK BRAKE MALFUNCTION will show in the message centre. Contact your nearest Aston Martin Dealer.

If the battery has been discharged or disconnected, APPLY FOOT AND PARK BRAKE will show in the message centre when the ignition is next ON. Press the foot brake down and pull the park brake switch up to put the park brake ON, this will reset the park brake system.

Electronic Stability Program (ESP)

⚠ Warning: *It is the driver's responsibility to drive safely according to the law and with due regard to prevailing conditions.*

⚠ Warning: *Electronic Stability Program (ESP) must never let the driver be tempted into taking risks which could affect his or her safety or that of other road users. ESP cannot overcome consequences of applying too much engine power for prevailing conditions.*

The Electronic Stability Program (ESP) is designed to improve driving safety when the tyres are at the limits of their grip capabilities. This is done by control of engine torque and application of the brakes at individual wheels.

⚠ Caution: *If repair or replacement of the steering or other surrounding equipment is necessary, always refer to your Aston Martin Dealer. There is a sensor in the steering system which detects steering angle. If the centre position of the steering deviates, the ESP may not operate correctly.*

⚠ Caution: *ESP may not operate correctly when using tyre chains.*

⚠ Caution: *Use tyres of the same manufacturer, brand, type, tread pattern and correct size specified in this handbook (Refer to 'Wheel and Tyre Information', page 12.15) for this vehicle on all four road wheels. Do not mix new and worn tyres on the same axle.*

ESP Modes

ESP has three modes of operation:

ON:

ESP defaults to ON each time the engine is started. The  will flash in the instrument cluster when in operation. ABS is set to stage one. Engine torque and application of the brakes at individual wheels will be controlled by ESP to aid stability.

TRACK MODE:

⚠ Warning: *TRACK MODE is intended for use on a dry track. Greater driver input will be required to maintain vehicle stability.*

Track mode raises the thresholds at which the ESP operates and allows greater wheel slip from the Traction Control System (TCS). Active Yaw Control (AYC) is also modified to allow a higher level of yaw. ABS is set to stage two. When the ESP is set to track, the message **ESP TRACK** will be shown in the left instrument cluster window.

OFF:

ESP no longer controls engine torque, and both TCS and AYC are disabled. ABS will remain in stage two. **ESP OFF** will show in the left instrument cluster window when the ESP is set to off.

Two-Stage Anti-lock Braking System (ABS)

The Anti-lock Braking System (ABS) will change its operation depending on ESP mode.

Stage One

When ESP is set to ON, the ABS is tuned to give a level of vehicle performance, control and stability under braking that will cover everyday driving situations and weather (dry, wet, ice and snow).

Stage Two

When ESP is set to Track or OFF, the ABS is tuned to allow more experienced drivers to drive closer to the limits of the vehicle's ability and enjoy its natural balance in a track environment.

When the ABS is set to stage two, the ABS is applied in the following ways:

- The Electronic Brake-force Distribution (EBD) increases braking force to the rear of the vehicle. This is done by allowing a greater level of slip at the rear axle and a quicker increase in pressure in the rear brakes. Cornering agility will be enhanced when braking, but the driver will experience more vibration through the brake pedal.
- The ABS will allow more slip when the tyres are at a higher working temperature, such as when the vehicle is driven on a track. The driver will have more control over brake performance before the ABS is activated.
- Braking performance is given greater priority over stability in areas with different friction surfaces. Increased steering input is required to maintain the direction of travel, but optimum vehicle deceleration is achieved.
- The ABS provides a more aggressive pressure increase for situations where a wheel can become temporarily unloaded, such as in track sections featuring fast, tight corners, strong cambers or high-speed crests.

Dynamic Torque Vectoring (DTV)

Dynamic Torque Vectoring (DTV) uses input signals such as speed, acceleration and steering angle to monitor vehicle behaviour during cornering. A small amount of brake pressure will then be applied to the inside rear wheel to reduce understeer. DTV is always active, but is more responsive when the ESP is set to either Track or OFF.

Traction Control System (TCS)

The Traction Control System (TCS) is a function of ESP and is used to prevent excessive wheel spin at standing starts, or during acceleration. Wheel spin is usually caused by excessive use of the accelerator pedal, or slippery, loose or bumpy road surfaces.

⚠ Warning: It is always the drivers responsibility to drive safely according to the law and with due regard to prevailing conditions.

⚠ Warning: Traction control cannot overcome the consequences of applying too much engine power for conditions, and must never let the driver be tempted into taking risks which could affect their safety or that of other road users.

To prevent wheel spin and maintain vehicle stability in such situations, the traction control system will:

- Brake either of the driven wheels when they start to slip.
- Adapt the engine torque to a level corresponding to the traction available on the road surface.

 *These symptoms are normal and will clear as wheel spin is eliminated and normal engine power is restored.*

 *If cruise control is on it will automatically go OFF when ESP is operating.*

If traction control operates when driving on extended icy or slippery surfaces, reduce engine power as necessary until the ESP warning symbol goes OFF.

Tyre Pressure Monitoring System (TPMS)

⚠ Warning: Driving on a significantly under-inflated tyre causes the tyre to overheat and can lead to tyre failure. Over-inflation and under-inflation also reduces fuel efficiency and tyre tread life, and may affect the vehicle's handling and stopping ability.

⚠ Warning: The TPMS is not a substitute for correct tyre maintenance, and it is the driver's responsibility to maintain correct tyre pressures, even if under-inflation has not reached the level to set the TPMS tyre pressure indicator symbol to ON.

A Tyre Pressure Monitoring System (TPMS) is installed as a safety feature. This system will display the tyre pressures for each tyre and provide warnings if pressure is below a specified pressure for each tyre.

Each tyre should be checked at least once every two weeks when cold, and inflated to the pressure recommended by the vehicle manufacturer (Refer to 'Wheel and Tyre Information', page 12.15) or on the tyre pressure label. If your vehicle has tyres of a different size than the size indicated on the tyre pressure label, you should determine the proper tyre pressure for those tyres.

Tyre Pressure Display

The TPMS display is shown in the right window of the instrument cluster. Use the right scroll wheel on the steering wheel to navigate to **Service** and select **Tyre Pressure**.

 Tyre pressures will be displayed in the instrument cluster after the vehicle has been driven for a few minutes.

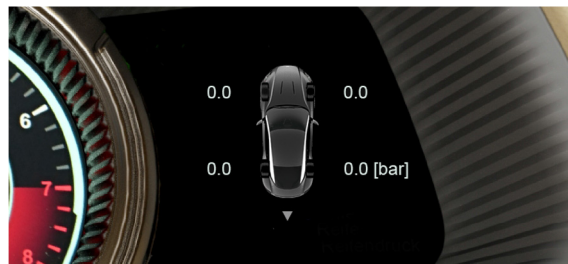

Tyre Pressure Indicator

If an under-inflated tyre is detected by the system, the TPMS

symbol  is **solidly illuminated**.

The message centre will also display one of the below messages:

- **Please Rectify Tyre Pressures:** At least one tyre has too low a pressure. Tyre pressures should be checked and corrected when possible.
- **Check Tyre(s):** At least one tyre has significantly low pressure. The tyre pressures must be checked and corrected as soon as possible.
- **Warning Tyre Defect:** At least one tyre has lost pressure very suddenly. The vehicle should be stopped as safely as possible and the tyres checked.

Once the message has been acknowledged an image of the vehicle will be displayed in the message centre showing which tyre(s) have low or high air pressure and the current tyre pressure. When the tyre pressure indicator comes ON, stop and check your tyres as soon as possible, and inflate or deflate them to the correct pressure.

 **Warning: When a tyre pressure warning is detected, reduce the vehicle speed to a safe level. Stop in a safe and convenient place and inspect the tyre(s).**

 *The tyre pressures may be displayed in the wrong positions for a short time if the wheels have been moved on the vehicle. After a few minutes of driving, the TPMS will calibrate and the tyre pressures are displayed in the correct positions.*

TPMS Reset

 *All warning messages are erased and warning lamps go out when the TPMS is reset. The TPMS will use the new tyre pressure values as reference values.*

To reset the TPMS tyre pressure values:

1. Use the right scroll wheel on the steering wheel to navigate to **Service**.
2. Navigate to **Tyre Pressure**.
3. Select **Use Current Pressures as New Reference Values**.
4. The TPMS will now reset. After a short period of driving, the system checks if the tyre pressures are within the specified range. The new tyre pressures are then used as the new reference values.

TPMS Malfunction Warning

If the TPMS malfunctions due to a system failure or tyre

transmitter fault,  will flash for approximately one minute and then remain lit.

 A malfunction of the tyre pressure monitor can take up to ten minutes to be shown. The TPMS warning lamp will go out when the fault has been resolved and after several minutes of driving.

A TPMS malfunction can be caused by:

- A defective TPMS sensor.
- Wheels and tyres installed that do not have TPMS sensors.
- Unapproved item interfering with the TPMS.
- TPMS system or software fault.

If the system shows there is a TPMS fault, continue at a reduced speed of 30mph / 48 km/h maximum. Contact your Aston Martin Dealer.

Radio Equipment Directive

Hereby, Schrader Electronics Ltd., declares that this TPMS is in compliance with the essential requirements and other provisions of directive 1999/5/EC. The declaration of conformity may be consulted at emcteam@schrader.co.uk

Cylinder Deactivation

(V12 Engine Only)

 Cylinder deactivation is only available when drive mode is set to GT.

Cylinder deactivation is used to shut off one bank of the engine when it is under light load. The system will operate at speeds between 30 mph (48 km/h) and 80 mph (130 km/h) from 4th gear and above, so is well suited to motorway driving.

When cylinder deactivation is in operation, the engine switches which bank is disabled to keep the catalysts at correct operating temperatures. Both banks will then become active immediately during acceleration, with no delay in engine performance.

Stop/Start

The Stop/Start function switches the engine off when the vehicle comes to a stop to reduce fuel consumption and emissions.

Setting On or Off

 Stop/Start is not available when drive mode is set to Sport+.





Stop/Start is controlled by the **START/STOP** button (A) on the centre stack. When the system is active the indicator LED on the button is lit.

Engine Stop Conditions

With Stop/Start active, the engine will switch off when the vehicle is completely stopped, the transmission is in either D (Drive) or N (Neutral) and if the following conditions are met:

- The vehicle battery condition is suitable.
- The bonnet is closed.
- The driver's door is closed.
- The driver's seatbelt is fastened.
- The engine is at operating temperature.
- The outside temperature is within a suitable range.
- The vehicle climate temperature has reached the set temperature.
- The engine has been on for a minimum of 20 seconds.

If any of the above conditions are not met when the engine attempts a stop/start event, the Stop/Start symbol will be shown in yellow .

When the engine is switched off, all the remaining vehicle systems will continue to operate (navigation, media etc). When the engine is switched off due to stop/start, the  symbol will be shown in the instrument cluster.

Gasoline Particulate Filter (GPF)

Engine Start Conditions

The engine will automatically start again when:

- The engine has been switched off for 3 minutes.
- The engine goes above or below operating temperature.
- The throttle pedal is pressed.
- The brake pedal is released.
- The steering wheel is turned.
- The **STOP/START** button has been pressed on the centre stack.
- R (Reverse) is selected.
- **Sport+** is selected for drive mode (Refer to 'Sport+ Mode', page 5.13).
- The driver's seatbelt is unfastened.
- The driver's door is opened.
- The vehicle begins to roll.
- The battery condition would prevent restart.
- The vehicle interior has dropped below or increased above the temperature set by the climate control system.

Emergency Stops

If the vehicle detects a level of braking that it determines to be an emergency stop, the stop/start will prevent the engine switching off.

The GPF system is used to reduce particulate emissions from the exhaust system. Particulates are stored in the exhaust system, and are burned off as the filter is filled in an event called regeneration, which happens automatically as the vehicle is driven. If the vehicle is only driven on short journeys or in cold environments where more particulates are generated during cold starts, a warning may be shown in the instrument cluster.

Stage 1 Warning

 *Regeneration should be completed in GT mode and without cruise control active.*

When the stage 1 warning is shown, the vehicle should be driven on a motorway or similar road where a constant and steady speed can be held for several minutes. As the vehicle is driven, the engine calibration is altered to increase the temperature in the exhaust and the filter element until it is high enough to burn the soot. After several minutes of driving, the throttle pedal should be released for a few seconds at a time (or when leaving a motorway junction). This will then enable the soot to be burned from the exhaust system. Repeat this procedure until the warning symbol is no longer shown in the instrument cluster.

If, after a period of driving and doing the above instructions, the warning lamp is still shown, contact your Aston Martin Dealer for assistance.

Stage 2 Warning

If the stage 2 warning is shown, there is a fault with the GPF system that means the vehicle cannot perform a regeneration. This can be a fault with the GPF electrical or pressure systems, or the filter itself, or that the accumulated particulate mass is too high, and cannot be safely burned. If this warning symbol is shown, contact your Aston Martin Dealer as soon as possible.

⚠ Warning: The park assist systems are for aid only. It is the driver's responsibility to be aware of their surroundings when parking or reversing.

Park Distance Control

⚠ Caution: It is always the driver's responsibility to detect obstacles and estimate the vehicle's distance from them. Some overhanging objects, barriers, thin obstructions or painted surfaces which could possibly cause damage to the vehicle may not be detected by the system. Always be aware of your surroundings when using the park assist systems.

⚠ Caution: Do not clean the sensors with abrasive or sharp objects. This can damage the sensors.

 For reliable operation, the sensors in the front and rear bumpers should be kept free from ice, frost and grime. If a high pressure spray is used to clean the vehicle, the sensors should only be sprayed briefly and not from a distance of less than 200 mm.

The Park Distance Control (PDC) system will give a series of warning tones if objects are detected within range of the vehicle.

Activation

PDC will activate automatically at ignition on and when D (Drive), R (Reverse) or N (Neutral) is selected. The sensors activated depend on which gear is selected.

(D) Drive	Front sensors only.
(R) Reverse, (N) Neutral	Front and rear sensors.
(P) Park	Sensors off.

Deactivation

PDC will deactivate when the vehicle speed exceeds 11 mph (18 km/h). The system is reactivated automatically when the vehicle speed is lower.

To manually deactivate PDC press . The indicator LED will be set to off to show the system is deactivated.

Operation

! Caution: In heavy rain or similar adverse conditions, the PDC sensors may not always be able to accurately measure distance to close objects. A fully laden vehicle or irregular obstacles may also cause inaccurate measurements. Take extra care in these circumstances.

If an obstacle is detected to the front or rear of the vehicle, a series of warning tones will be heard from the front or rear speaker respectively. The frequency of the warning tones increase as the vehicle approaches the obstacle.

The beep becomes a continuous tone when an obstacle is detected at or within approximately 300 mm from the rear or 250 mm from the front of the vehicle.

The LED will flash if a fault is detected in the system and a single three second tone will be heard (only once per ignition cycle). The system is automatically disabled when a fault is detected.

 *If an ultrasonic frequency using the same frequency band as the sensors is detected, the PDC system can give spurious warning tones.*

 *The PDC system uses inner and outer sensors. When manoeuvring forward into a garage, the front outer sensors will cease detection if they detect a stationary or receding object for three seconds or more. This allows detection directly in front or behind the vehicle in this type of manoeuvre.*

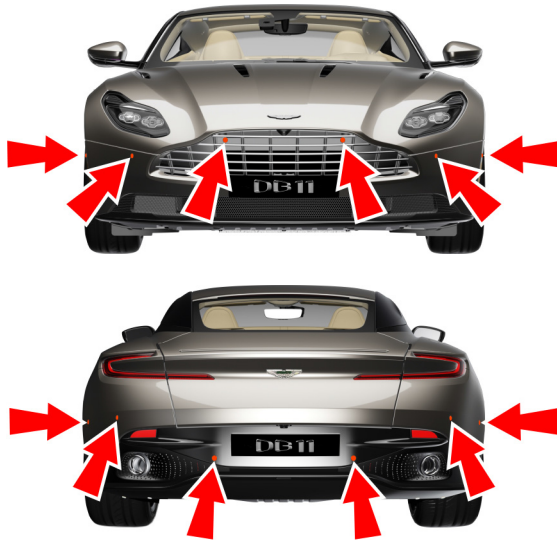

Active Park Assist

(Optional)

Active Park Assist measures the road on both sides of the vehicle to locate a parking space the vehicle will fit in. The active park system will also provide vehicle steering to assist parking in spaces.

Important Safety Information

Active Park Assist is only an aid. It is the driver's responsibility to be aware of their surroundings when parking or reversing. Make sure that no persons, animals or objects are in the vehicle's path.

 Active Park Assist is not available if PDC is deactivated or not functioning.

⚠ Warning: While parking, the vehicle can move into areas of oncoming traffic. This can cause a collision with other road users. Stop the vehicle or cancel the Active Park Assist parking procedure if necessary.

⚠ Caution: *Parking spaces that are partially occupied may be measured incorrectly. Examples of partially occupied parking spaces can be trailer draw bars, over grown parking spaces or incorrect measurement due to heavy rain or snow. Care should be taken to make sure the space is clear.*

⚠ Caution: *Active Park Assist will not be able to detect objects above the sensor height range when a parking space is measured. These object will not be included when the parking procedure is calculated. Active Park Assist should not be used around objects such as overhanging loads or tail sections of goods vehicles.*

 Active Park Assist can be cancelled at any time by manually controlling the steering wheel.

 Active Park Assist may also display parking spaces that are not suitable such as prohibited parking zones, driveways or unsuitable road surfaces.

 Active Park Assist should only be used for roads that are parallel or at right angles to the direction of travel and on the same road level. The system should not be used for measuring spaces on bends or on raised footpaths.

Parking Space Detection

 Active Park Assist operates at speeds of up to approximately 22 mph (35 km/h).

Active Park Assist is activated automatically when driving forwards and independently locates and measures parking spaces on both sides of the vehicle.

At speeds below 18 mph (30 km/h),  will show in the instrument cluster. When a parking space has been detected that the vehicle will fit into, a left or right arrow will show which side of the vehicle the space is on.

Active Parking Assist will only detect parking spaces that are:

- parallel to the direction of travel and at least 1.5 m (5 ft) wide and 1 m (3.3ft) longer than your vehicle.
- at right angles to the direction of travel and at least 1 m wider than your vehicle.

 Active Park Assist is not able to measure the depth of a parking space if it is at right angles to the vehicle. You must judge if your vehicle will fit in the parking space.

The system automatically determines if the parking space is parallel or at right angles to the direction of travel.

 A parking space is displayed while you are driving past it, until you are approximately 15 m (50 ft) away from it.

Active Park Assist does not assist with parking in right angle space if:

- two parking spaces are located directly next to each other
- the parking space is directly next to a low obstacle such as a low kerb
- forward-parking

Active Park Assist will only display parking spaces on the front-passenger side as standard.

Parking spaces on the driver's side will be displayed if the turn signal on the driver's side is on. The indicator must remain on, until Active Park Assist is confirmed.

Parking with Active Park Assist

When a parking space has been found and is shown in the instrument cluster, stop the vehicle and select R (Reverse).

- **Start Park Assist?** will show in the instrument cluster display.

Press **OK** on the scroll wheel to confirm. To cancel press  or continue to drive away from the space.

- Release the steering wheel and slowly reverse the vehicle, being ready to brake at all times. Reversing at a speed above 6 mph (10 km/h) will cancel Active Park Assist.

⚠ Warning: The vehicle will not automatically brake if an object is detected.

Additional manoeuvring may be required in tight parking spaces. If it is necessary for the vehicle to move forward, a message will show in the right message window. Select D (Drive) while the vehicle is stationary. Active Parking Assist will then counter-steer to change the approach angle.

360° Camera System

⚠ Caution: *The camera system can show a distorted or incorrect view of obstacles or not at all. Obstacles will not be shown under, or in very close proximity to, the front or rear bumpers. Care should also be taken in the blind spots close to the door mirrors, tailgate or transitional areas between cameras in the top-down view.*

⚠ Caution: *Objects that are not at ground level can appear further away than they are. Care should be taken when manoeuvring around items such as tow bars and vehicle bumpers.*

The 360° camera system uses four cameras (front, rear and both door mirrors) to give a complete view of the vehicle's immediate surroundings. The system can then be used in a split screen view to suit different driving scenarios.

Activation

To activate the 360° camera, press the  button or select **360° cameras** from the **Vehicle Settings** menu. The camera will show the split screen with either the front or rear view, depending on the transmission selection.

 *The camera system will be disabled when the vehicle speed exceeds 16 km/h (10 mph). At higher speeds the camera display will still be selected, but no image will be shown.*

The system will display images again when the vehicle speed drops below 11 km/h (7 mph).

 *The ignition must be on for the cameras to operate.*

View Selection



To select the different views, push up on the **CONTROL DIAL** to the view selection bar. The split-screen views that can be shown are:

- Top 360° view with rear view
- Top 360° view with top down rear view
- Top 360° view with rear corner view
- Top 360° view with front corner view
- Top 360° view with top down front view
- Top 360° view with front view

180° View

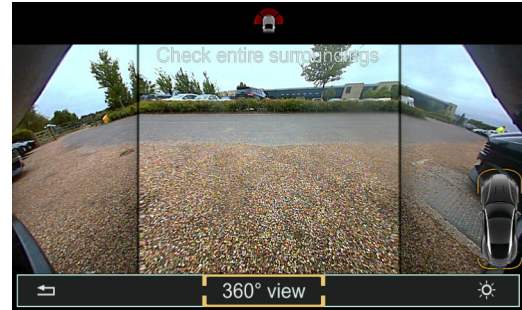

When the camera shows the front or rear view, select **180° view**. This will replace the split-screen view and show a much wider angle for the front or rear.

Top View with Park Distance Control (Front and Rear views)

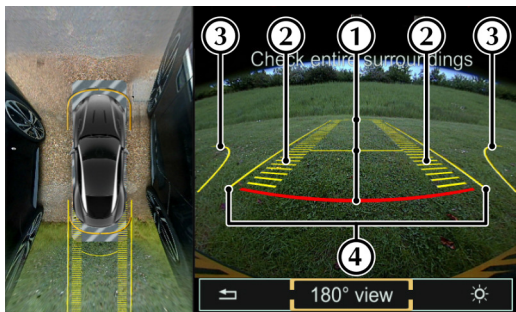

Top View with Corner Views

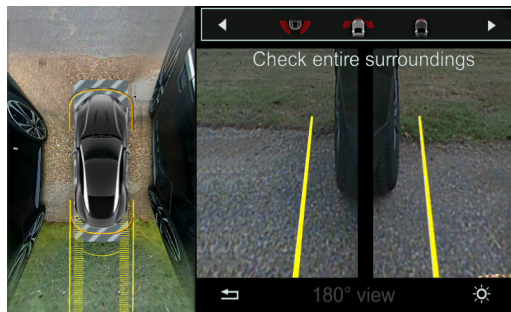

To aid with parking the vehicle, a dynamic overlay screen will be shown over the camera image. The overlay screen adjusts with steering angle and shows the following information:

1. Distance markers (0.3 m, 1.0 m and 4.0 m)
2. Projected tyre path
3. Maximum steering angle
4. Maximum vehicle width guideline (includes door mirrors)

The corner view cameras show both sides of the vehicle from the door mirrors. The yellow lines overlaid on the camera view show the maximum width of the vehicle, including the door mirrors.

Activation by Reverse

The top 360° view with rear view can be set to activate automatically when R (Reverse) is selected (Refer to 'System Settings', page 10.3).

Emergency Call System

ERA-GLONASS

(Russia Only)

The ERA-GLONASS system provides the user with an emergency call system. This system can be used to reduce the time the emergency services take to arrive at an accident, by making them aware an accident has occurred and providing information such as location. The system used the GLONASS satellite network to provide an accurate location for emergency services to find the site of an accident.

An emergency call can be made automatically or manually.

 When the ignition is set to on, the red LED will light on the SOS button while the system is performing a self-test. It will be replaced by a green LED within one minute if there are no errors. If the red LED is on, contact your Aston Martin dealer.

Manual Operation

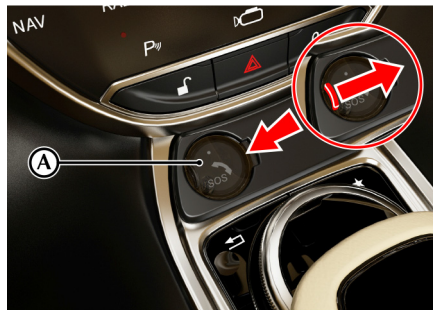

An emergency call can also be made manually. Slide the cover to the right and press the **SOS** button (A) to contact an ERA-GLONASS operating centre.

This can be used in the event of an accident that was not severe enough to deploy the airbags, but still requires assistance from the emergency services. The system can also be used if you witness and want to report a severe accident but are not actually involved in the incident.

 An emergency call should only be made if you or others are in need of rescue. Do not make an emergency call in the event of a breakdown or a similar non-emergency situation.

Automatic Operation

The ERA-GLONASS system is directly connected to the Occupant Restraint Control (ORC) system. If the ORC system detects a crash scenario and deploys the airbags, vehicle information will be sent to a ERA-GLONASS operating centre.

When this happens:

- A 2-way voice call is automatically opened with an ERA-GLONASS operator.
- An automated text message is sent to the Operating Centre to advise that an accident has occurred and will provide information such as location.

 *In the event that the ERA-GLONASS operator attempts to contact you and there is no answer, such as if the vehicle occupants are unconscious, the emergency services will be automatically dispatched to your location.*

Malfunction Warning

In the unlikely event of a fault with the ERA-GLONASS system, the red LED in the SOS button will stay as constantly red. If the LED is constantly red or does not show constant green when the system is not in use, contact your Aston Martin Dealer for assistance.



ASTON MARTIN

Climate Control

Climate Controls	6.2
Climate Menu	6.5
Defrost and Demist	6.7
Air Distribution Vents	6.8
Climate Control Operating Tips	6.8

Climate Controls

Centre Stack Climate Controls

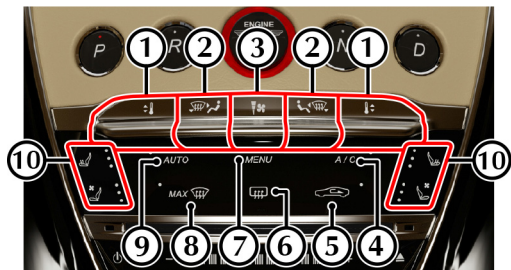

[1] TEMPERATURE:

Press the rocker switch up or down to increase or decrease the temperature.

[2] AIR DISTRIBUTION:

Press the rocker switch up or down to change airflow modes.

[3] AIRFLOW SPEED:

Press the rocker switch up or down to increase or decrease the fan speed.

[4] A/C:

When in manual mode press and release to set the air conditioning ON or OFF.

[5] AIR CIRCULATION:



⚠ Warning: Re-circulated air can cause the interior glass to mist up in cold or rainy weather. If demisting is required, use the air conditioning.

Controls the source of air entering the vehicle. Press to select re-circulated air (button LED ON). Press and hold for more than two seconds to close the windows.

Press again to select outside air as source (button LED off). Press and hold for more than two seconds and the windows will open to their last position¹.

Use the re-circulated air position when going through tunnels, driving in congested traffic (high engine exhaust areas) or when maximum cooling is required.

Outside air is used as the default air source and should be used for normal conditions and demisting.



[6] HEATED REAR WINDOW:



Press to set the rear window and door mirror heaters ON or OFF. The rear screen heater will automatically set to OFF after 20 minutes and the door mirror heaters set to OFF after 6 minutes.

[7] MENU:



Opens the **Climate** menu (Refer to 'Climate Menu', page 6.5).

¹ If windows were open before selecting re-circulated air.

[8] DEMIST:

Press for maximum defrost or demist ON or OFF. Outside air intake is automatically selected and air conditioning is automatically started.

[9] AUTO:

Press for automatic climate control (Refer to 'Automatic Climate Control', page 6.4).

[10] SEAT HEATING/COOLING:

⚠ Warning: Do not press the seat heater switch repeatedly. This can cause the seat to become very hot and can cause burn injuries to persons with limited sensitivity to temperature changes.

- **Seat Heating** (standard):

Press to cycle the seat heating level on the driver or passenger seats. The LEDs show which heating level is set, where the higher the number of LEDs illuminated, the greater the heating level.

- **Seat Cooling** (optional):

Press to cycle the seat cooling level on the driver or passenger seats. The LEDs show which cooling level is set, where the higher the number of LEDs illuminated, the greater the cooling level.



Infotainment Climate Controls



[1] TEMPERATURE:

Open the temperature list.

[2] AIR DISTRIBUTION MODES:

Open the air distribution list.

[3] AIRFLOW:

Open the airflow speed list. Select a fan speed from 1 to 7 or select AUTO.

[4] CLIMATE MENU:



Shows the Climate Mode setting and Air Conditioning status. Select to open the Climate Menu (Refer to 'Climate Menu', page 6.5).

Automatic Climate Control

The temperature is maintained at a set level in automatic mode. The climate system will automatically control the temperature, airflow and the air distribution according to the interior and exterior conditions.

To set a temperature for automatic operation:

- Set a temperature.
- Press 
- The LED indicator lamp will switch on.

 Press and hold  to set the climate control to a default setting of 22°C, low fan speed and vents open.

 Maximum fan speed will not be available until the engine has reached its normal operating temperature.

 Any changes to the air distribution or airflow speed will cancel automatic climate control.

Manual Climate Control

Manually set the temperature, airflow speed and air distribution:

 **Warning: Re-circulated air can cause the interior glass to mist up in cold or rainy weather. If demisting is required, use the air conditioning.**

 To prevent cold air blowing from the vents, airflow speed is reduced until the engine warms up.

 The climate system will produce the selected temperature regardless of in-vehicle conditions.

For an increased cooling effect, press  to use re-circulated air.

Climate Menu

The climate control system can also be operated within the infotainment system. Use the **CONTROL DIAL** or the applicable rocker switch or dial to adjust each function.

Climate Mode



Select one of three modes:

- [1] **MEDIUM:** Standard airflow with medium airflow.
- [2] **FOCUS:** High level of airflow at a cooler temperature setting.
- [3] **DIFFUSE:** Low level of airflow at a warmer temperature setting.

Temperature

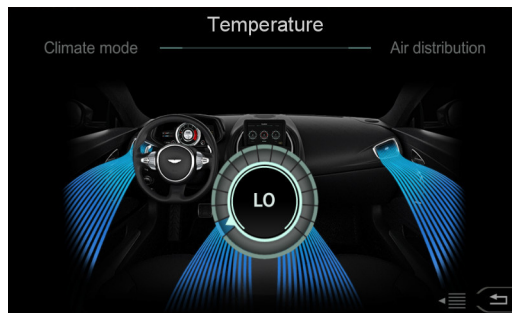

Rotate the **CONTROL DIAL** to set the temperature.

Air Distribution



Rotate the **CONTROL DIAL** to choose an air distribution mode.

Airflow



Rotate the **CONTROL DIAL** to choose an airflow speed from between 1 and 7 or **AUTO**.

Climate Options



[1] SYNC.:

Select to synchronise the left and right climate zones. Only one setting dial will be shown when climate conditions are being set.

If **SYNC** is set to OFF, push the **CONTROL DIAL** left or right to select which zone to adjust.

[2] CLIMATE CTRL ON:

Press **ENTER** to set the climate control to ON or OFF.

[3] A/C:

Press **ENTER** to set the air conditioning to ON or OFF.

[4] BACK:

Return to the main menu screen.





⚠ Caution: To defrost or demist the windscreen on vehicle start up in extreme cold weather conditions, operate the engine at 1500 rpm. Always make sure that the transmission is in P (park) and the park brake is applied.

Press . The outside air intake is automatically selected, the temperature is set to maximum and air conditioning is started.

 If the engine is cold the air conditioner will not start up until the engine has started to warm up.

To cancel automatic defrost or demist either:

- Press  again.
- Press .
- Select a different airflow mode.

 The automatic defrost setting times out after 6 minutes.

Air Distribution Vents

To adjust the air vents, use the vent knob (A). Push up or down to adjust the blades inside the vent. Push left or right to adjust the angle of the vent unit.

Rotate the knob to open or close the vent.

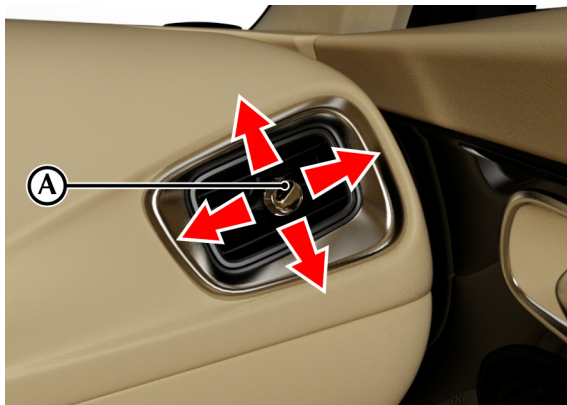

Climate Control Operating Tips

- Moisture which forms on the evaporator in the air conditioning unit is discharged via a drain tube onto the road. After stopping, small puddles of water may form underneath the vehicle. This is normal and does not show a system malfunction.
- Set the climate system to off when in a car wash or if the vehicle is being pressure washed.
- Air conditioning may not function when the outside temperature approaches -6°C (indicator stays on even when system is off).
- Windows can fog up easily in humid weather. Use the climate control system to demist the windows.
- Clear all obstructions like leaves, snow and ice from the bonnet and the air inlet below the windscreen to improve the system efficiency.
- Use the 'outside air' position in normal conditions. The 're-circulated air' position should be used temporarily when driving on dusty roads or for quick cooling or heating of the interior.
- If the vehicle has been parked in direct sunlight during hot weather, open the windows to let warm air escape, then close the windows and operate the climate control system.
- Operate the climate control system at least once a month to keep internal parts lubricated.
- Have the climate control system checked before the weather gets hot. If the climate control system is low on refrigerant or has a malfunction, consult your Aston Martin Dealer.
- Mist may come out from the vents when using the air conditioning. This is humid air being suddenly cooled and not a sign of a malfunction.

Phone System

Hands-Free Controls	7.2
Device Management	7.2
Phone Features	7.5

Hands-Free Controls

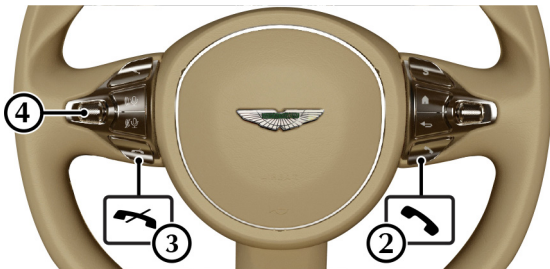

[1] **TEL**: Press to access phone menus.

[2] **CALL** : Press to answer a phone call.

[3] **END CALL** : Press to end a call.

[4] **VOLUME/MUTE**: Scroll to increase or decrease call volume. Press to mute.

Device Management

Bluetooth®¹ technology is a standard for short-range wireless data transmissions up to approximately 10 metres. Bluetooth can be used to connect your mobile device to the vehicle infotainment system. This system can then be used to operate the hands-free phone system, Bluetooth audio streaming and internet access.

Bluetooth Activation

The vehicle's Bluetooth system can be turned on or off. Before a device can be paired with the vehicle, the vehicle's Bluetooth system must be switched to on.

To set the vehicle Bluetooth system on:

- Navigate to **VEHICLE** on the main menu.
- Select **System Settings**.
- Select **Activate Bluetooth** and set to on.



1. The Bluetooth® word mark and logos are registered trademarks owned by Bluetooth SIG, Inc., and any use of such marks by Aston Martin is under license. Other trademarks and trade names are those of their respective owners.

Pairing a Device

 Bluetooth must be activate on both the vehicle and the mobile device to be used.

Before a device can be used, it must be paired to the infotainment system.

To add a new device, select **TEL** from the main menu and select **Connect Device**. Select **Search for Phones** or **Search via Telephone**.

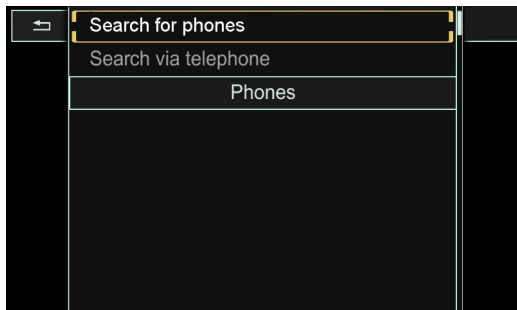

Search for Phones

 The mobile device must be set to discoverable mode. Refer to the mobile device manufacturers instructions.

Select **Search for Phones** to begin a search for available visible devices. Any devices with a tick next to them have already been paired with the infotainment system. Scroll to the required device and press **ENTER**. Follow the instructions shown on the device and the infotainment display to pair.

Search via Telephone

Select **Search via Telephone** to set the infotainment system to 'listen' for a device. Follow the device manufacturer's instructions to search and connect to a new Bluetooth connection in range. Select Aston Martin DB11 from the device list.

 If the vehicle does not show, check that Bluetooth is active in the infotainment system and search again.

Follow the instructions shown on the device and the infotainment display to complete pairing.

Completing Device Pairing

Once the mobile device is paired, it is ready for use with the vehicle audio and hands-free system. The infotainment system will also request access to call history, contact list and messages.

After authorisation, the infotainment system attempts to connect with the last two devices used automatically. You can authorise up to 15 devices, but only one device can be connected to the multimedia system at a one time.

Selecting a Device

When more than one device has been paired, you can choose which to use for an active connection. To choose a device, select **Connect Device**. Scroll through the list and select the device to be used.

 Only one device can be used for an active connection at any one time. The active device is indicated by a dot in the device list.

 You cannot change the active device during a call.

Device Details

To show device details, select **TEL** from the main menu and navigate to **Connect Device**. Scroll through the list and select a device.

Push the **CONTROL DIAL** right and select *Details*. The below information will be shown:

- Bluetooth device name
- Bluetooth address
- Availability Status
- Authorisation status

Deleting a Device

To delete a device, select **TEL** from the main menu and navigate to **Connect Device**. Scroll through the list and select the device to be deleted.

Push the **CONTROL DIAL** right and select **De-authorise**. A message will show to ask if you really wish to remove this device. Press **ENTER** to confirm.

Phone Features

Contact Lists

The contact list displays all available contacts for your phone contacts which have a phone number.

To access the contact list press **TEL** on the centre stack or navigate to **Telephone** to open the phone menu. Select **Name** to show the list of contact names. Phone contacts will be displayed in alphabetical order.

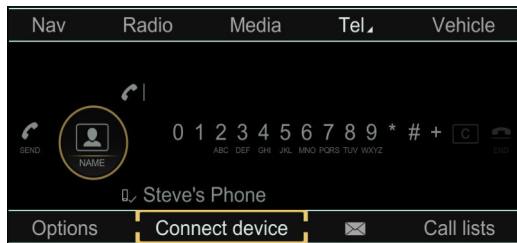

Call lists

Select **Call Lists** and choose **Incoming Calls**, **Calls Dialed** or **Speed Dial Preset List**.

Calls

Make a Call

A call can be made in several ways:

- Choose a contact from the **Contacts list**.
- Enter a number using the on screen number pad.

Press  on the steering wheel, or press **ENTER** on the **Send** icon to begin a call.

End a Call

To end a call, press  on the steering wheel, or press **ENTER** on the **End Call** icon.

Answer a Call

To answer an incoming call, press , or press **ENTER**.

Reject a Call

To reject a call, press , or select **Reject Call** and press **ENTER**.

Second Incoming Call

If there is an incoming call during an active call, press  to answer the new call and put the original call on hold.

To reject the call press , or select *Reject Call* and press **ENTER**. Depending on the mobile manufacturer or network supplier, one of the following actions will occur:

- The incoming call is rejected, and the original call is continued.
- The incoming call is accepted, and the original call is ended.
- Both calls will be ended.

Microphone ON/OFF

To turn the microphone on or off during a call select **Microphone Off** and press **ENTER**.

Multiple Call Handling

(Network Provider Dependant)

Add a Call

To make a second call during a call, select the 2ND CALL icon and select a contact. The first call will then be held.

Switch Calls

If there are multiple calls active, they will be marked as 1ST CALL and 2ND CALL. The active call will be highlighted. To switch between calls, select the call you wish to make active and press either **ENTER** or . Selecting a new active call will put the inactive call on hold.

To end the active call, select the END CALL icon on the display and press **ENTER** or press .

To make the call on hold active, press .

 *The held call can be activated automatically when the active call is ended, depending on network supplier or mobile phone.*

Conference Call

If there active and held calls, a conference call can be used to have all calls active at the same time. During an active call, select *Conference* on the telephone menu and press **ENTER**. The held call participant will then be added to the active call.

Messages

 The connected mobile phone must support Message Access Profile (MAP) to be able to access text and email messages. This may have to be confirmed separately for some devices when paired to the vehicle.

Select  on the lower information bar to open the messages menu.

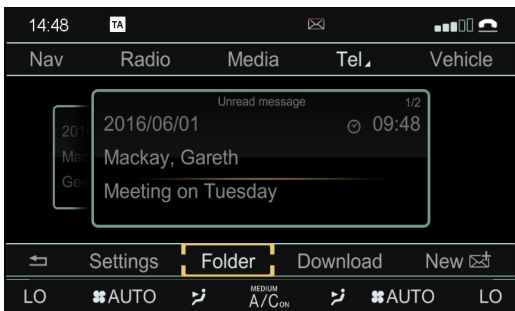

The  symbol will be shown at the top of the screen when new messages are received. New messages will be shown in the centre display.

The lower information bar has the below options:

[1] BACK:

Return to phone menu.



[2] SETTINGS:

Opens the message settings to set automatic message downloads.

- **All Messages:** Downloads all messages when the phone is connected.
- **New Messages:** Only show new messages when the phone is connected.
- **Off:** Do not show messages.

[3] FOLDER:

Open to view text messages:

- Inbox.
- Outbox.
- Drafts.

[4] DOWNLOAD:

Download messages from the phone to view on the infotainment screen.

[5] NEW MESSAGE:

Open the message entry window.

Message Entry



Push up with the **CONTROL DIAL** to select a contact to send a message to. From the Contact entry bar, push down on with the **CONTROL DIAL** to select the message entry window.

[1] TEXT TEMPLATES:

Opens a list of common phrases to be entered into a message.



[2] RETURN:

Starts a new line of text.



[3] CASE:

Switch between upper and lower case characters.



[4] NON-ALPHABETICAL CHARACTERS:

Show numbers and miscellaneous characters.



[5] LANGUAGE:

Select to open the languages list. characters sets will then be set to suit individual languages.



[6] CLEAR:

Select to clear a character. Press and hold **ENTER** to clear the whole message.



[7] OK:

Press **ENTER** to send the message.



Media Systems

Audio Specification	8.2
Multimedia Controls.....	8.4
Radio	8.5
Radio Menu	8.6
Media	8.10
Media Menu	8.12
Media Register	8.16
Bluetooth Audio.....	8.16
Sound	8.17

Audio Specification

Radio

- Digital Audio Broadcasting (DAB) radio.
- AM and FM radio.

Inputs

- 2 x USB ports in centre storage tray.
- SD Card reader in centre storage tray.
- Bluetooth® Wireless technology.
- CD/DVD reader in centre stack.

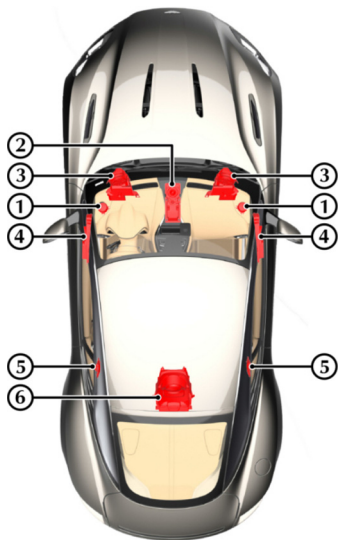

Aston Martin Standard Audio

Power Output

7 Channel 320W Audio System.

Speakers

[1] TWEETERS:

Two 25 mm tweeters.

[2] CENTRE SPEAKER:

Not Installed.

[3] FOOTWELL WOOFERS:

Two 165 mm woofers in enclosed cabinets.

[4] DOOR SPEAKERS:

100 mm mid-range speaker in enclosed cabinet in each front door.

[5] REAR QUARTER SPEAKERS:

100 mm mid-range speaker with 19 mm tweeter in each rear quarter panel.

[6] SUBWOOFER:

Not Installed.

Aston Martin Premium Audio

Power Output

10 Channel 640W Audio System.

Speakers

[1] TWEETERS:

Two 25 mm tweeters.

[2] CENTRE SPEAKER:

100 mm dual voice coil mid-range speaker.

[3] FOOTWELL WOOFERS:

Two 165 mm woofers in enclosed cabinets.

[4] DOOR SPEAKERS:

100 mm mid-range speaker in enclosed cabinet in each front door.

[5] REAR QUARTER SPEAKERS:

100 mm mid-range speaker with 19 mm tweeter in each rear quarter panel.

[6] SUBWOOFER:

200 mm dual voice coil subwoofer housed in the rear environment.

Bang and Olufsen Audio

Power Output

13 Channel 1000W Audio System.

Speakers

[1] TWEETERS:

Two 19 mm (soft dome) tweeters incorporating Acoustic Lens Technology (ALT).

[2] CENTRE SPEAKERS:

100 mm dual voice coil mid-range speaker with 19mm tweeter.

[3] FOOTWELL WOOFERS:

Two 160 mm woofers in enclosed cabinets.

[4] DOOR SPEAKERS:

100 mm mid-range speaker in enclosed cabinet in each front door.

[5] REAR QUARTER SPEAKERS:

100 mm mid-range speaker with 19 mm tweeter in each rear quarter panel.

[6] SUBWOOFER:

One 200 mm subwoofer centre housed in the rear environment.

Multimedia Controls



[1] DISC SLOT:

Slot to insert a CD or DVD disc.

[2] EJECT:

Press to eject disc.



[3] MEDIA:

Opens the **Media** screen (Refer to 'Media', page 8.10).

Opens the media source list if media screen is already open.



[4] VOLUME CONTROLS:

Press to increase and to decrease volume. Sliding a finger along the volume bar will also increase or decrease volume.



 *Volume can also be controlled by the left scroll wheel on the steering wheel.*

[5] RADIO:

Open the **Radio** screen (Refer to 'Radio', page 8.5).

Opens the radio source list if media screen is already open.



[6] POWER:

Press to turn the infotainment system on or off.



Radio

Press **RADIO** on the centre stack or select **Radio** from the main menu to open the *Radio* screen.

The display area will show the currently selected radio station and available radio stations.



Press **RADIO** again or select **Radio** to open the menu of available radio sources:

- FM/DAB Radio¹.
- AM Radio.
- Radio Presets.

Rotate the **CONTROL DIAL** to select a radio source and press **ENTER**.

¹. DAB where available

Radio Stations

Selecting a station from the display screen

The display screen shows available stations that can be played. Rotate the **CONTROL DIAL** with the centre display highlighted to select a radio station.

Selecting a station from the current stations list

Press **ENTER** with the centre display highlighted to open the current stations list.



Rotate the **CONTROL DIAL** to select a radio station and press **ENTER**.

Radio Menu

On the lower bar of the radio screen there will be several option buttons:

- Options
- Search (FM/DAB only)
- Preset
- Waveband
- Information (FM/DAB and preset station only)
- Sound

Options

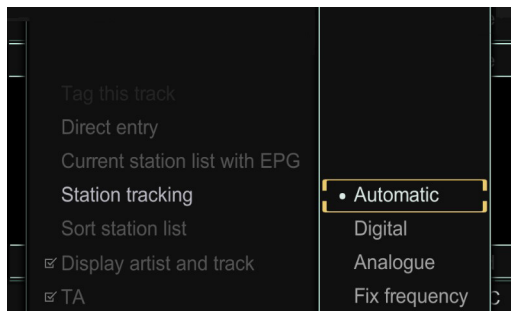

- Tag This Track (FM and Radio Presets Only)
- Direct entry
- Current Station/ Channel Listing (AM, FM and Radio Presets Only)
- Current Station with EPG (DAB)
- Station Tracking (FM and Radio Presets Only)
- Sort Station List (FM and Radio Presets Only)
- Display Artist and Track (DAB, FM and Radio Presets Only)
- TA

Tag This Track

(FM and Radio Presets)

Select to tag the track currently being played. Tagged tracks can then be later downloaded using a mobile phone¹.

Direct Entry

Opens a window to enter the frequency or preset number for a radio station.

Current Station/Channel Listing

(AM, FM and Radio Presets)

Opens a list of available stations.

Rotate the **CONTROL DIAL** to select a radio station and press **ENTER**.

Current Station with EPG (Electronic Programme Guide)

(DAB Radio)

Opens a list of available stations.

Rotate the **CONTROL DIAL** to select a radio station and press **ENTER**.

The programme title will show beneath the station name along with a timeline of available programmes.

Sort Station List

(FM and Radio Presets)

Sort available stations alphabetically or by genre.

Station tracking

(FM and Radio Presets)

Select whether the radio system automatically adjusts frequency for best reception. Select whether station tracking operates **Automatically**, or only for **Digital** or **Analogue** frequencies.

Fix frequency forces the radio to stay on the selected frequency, even if one with better reception is available.

Display Artist and Track

(DAB, FM and Radio Presets)

Select whether artist and track information is shown in the display screen.

TA

Select whether traffic announcements are switched ON or OFF. A TA symbol will appear on the display screen if traffic announcements are switched ON.

¹. Mobile phone dependant

Search

Opens a window to enter the keywords to find a radio station.

Preset



- Stations Preset View
- Save Current Station
- Edit Station
- Enter Preset

Stations Preset View

Select to switch between AM/FM and Station presets in the display screen.

Save Current Station

Save the current station to the presets lists.

Rotate the **CONTROL DIAL** to select a slot in the presets list and press **ENTER** to save the radio station.

Edit Station

Opens the list of preset stations.

Rotate the **CONTROL DIAL** to select a slot in the presets list and press **ENTER** to open the edit options:

- Save Current Station
Overwrites the highlighted station preset with the station that is currently playing.
- Move Highlighted Station
Moves the highlighted station to another slot in the presets list. Rotate the **CONTROL DIAL** to select a new slot and press **ENTER** to save the preset in the new position.
- Delete Highlighted Station
Deletes the highlighted preset station.

Enter Preset

Opens a window to enter the frequency or preset number for a radio station.

Waveband



Select between FM/DAB and AM wavebands.

Information

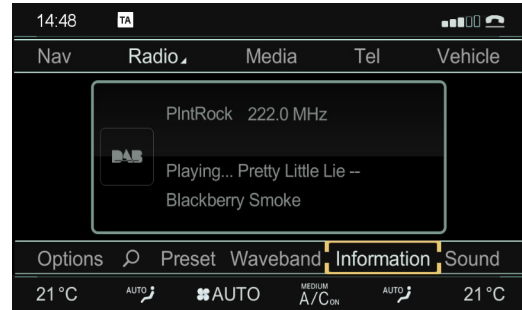

Select whether to show the available stations list or information about the current station.

Sound

Opens the *Sound* menu screen (Refer to 'Sound', page 8.17).

Media

Press **MEDIA** on the centre stack or select **Media** from the main menu to open the media *Now Playing* screen.

 *Now Playing* screen layout will depend on the media device last used.

Now Playing

Media

The *Now Playing* screen shows track information such as album art, artist and album name on the left side of the screen along with track play time and track number. Media source device and track name are shown on the right side of the screen.



Video files can also be supported with the infotainment system. To select full screen display, highlight the view window area and press **ENTER**.

DVD Video Media

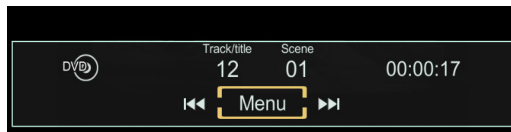

The *Now Playing* screen initially shows video in full screen mode. Press **ENTER** to bring up the basic DVD information bar which shows media source, track/title number, scene number and play time. Press **ENTER** on **Menu** to show the upper and lower information bars. Media playback will continue.

To return to full screen display, push up or down on the **CONTROL DIAL** to highlight the display area and press **ENTER** on the full screen symbol .

Media Sources

Press **MEDIA** or select **Media** from the main menu with to show the available media sources. Rotate the **CONTROL DIAL** and press **ENTER** to select a media source.

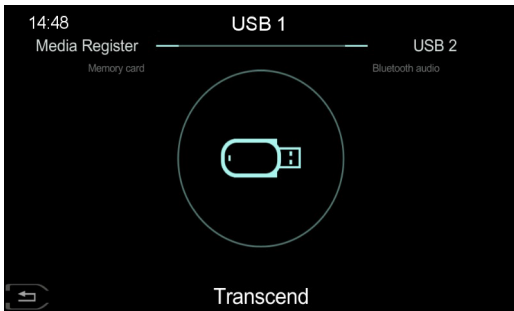

Select from the following media sources:

- Disc
- Memory Card
- Media Register
- USB 1
- USB 2
- Bluetooth Audio

Alternatively, select a media source from *Devices* (Refer to 'Devices', page 8.15).

Media Formats and File Systems

Media Formats

Audio

- .MP3₁
- .WMA₂₃
- CD-A
- AAC formats₄
 - .aac
 - .mp4
 - .m4a
 - .m4b

 *It is recommended to use tracks of at least 128 kbit/s bit rate and 44 kHz sampling rate to prevent a loss of sound quality.*

Video

- DVD-V
- MPEG
- WMV
- M4V
- AVI (up to 720p)

1. Fixed and variable bit-rates between 32 kbit/s to 320 kbits/s. Sampling rates between 8 kHz and 48 kHz

2. Fixed bit-rates between 5 kbit/s to 384 kbits/s. Sampling rates between 8 kHz and 48 kHz

3. DRM encrypted files, variable bit rate, WMA Pro and 5.1 Surround files are not supported.

4. Copy-protected iTunes® music files with the .m4p file extension are not supported.

Media Menu

File Systems

CD

- CD-R
- CD-A
- CD-RW

DVD

- DVD-R
- DVD-V
- DVD-RW

USB and SD Memory Card

- FAT16
- FAT32
- exFAT
- NTFS

On the lower bar of the *Media* screen there will be several options:

- Options
- Play/Pause
- Search
- Devices
- Sound

Options

Media Options

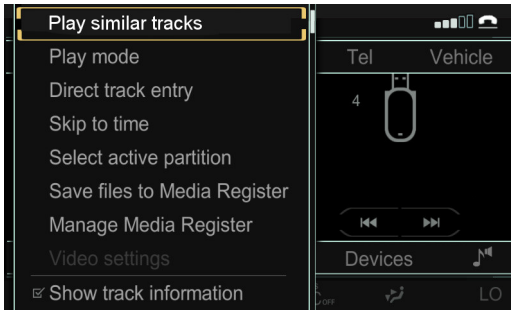

- Play similar tracks
- Play mode
- Direct track entry
- Skip to time
- Select active partition
- Save files to Media Register
- Manage Media Register
- Show track information

DVD Video Options

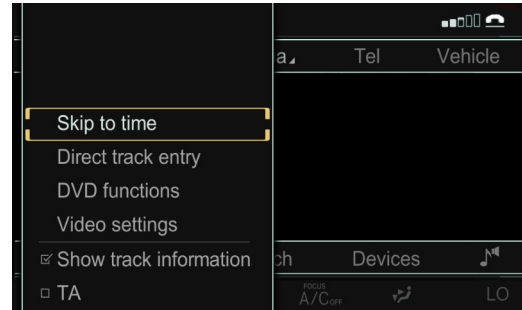

- Skip to time
- Direct track entry
- DVD functions
- Video settings
- Show track information
- TA

Play Similar Tracks

Play tracks that are of the same genre.

Play Mode

Select from *Normal Track Sequence*, *Random Track List* or *Random Media*.

Direct Track Entry

Manually enter track name.

Skip to Time

Rotate the **CONTROL DIAL** to select a set time in the track. Press **ENTER** to play.

Select Active Partition

(USB devices only)

Select which partition to use if more than one partition is available.¹

Save Files to Media Register

Save the current file or files to vehicle's internal hard drive.

Manage Media Register

Opens the *Media Register* options menu. (Refer to 'Media Register Options', page 8.16)

Video Settings

Opens video settings menu².

Show Track Information

Set whether artist and track information is shown in the display screen.

DVD functions

Opens the DVD function menu.



- Return to full screen display.



- Pause playback.



- Stop playback.



- Select Language.



- Subtitles.



- Change aspect ratio.



- Return to start of scene or chapter.

¹. Up to 9 partitions can be supported.

². Only available if a device contains video files.

Search

Search for a media file from a list of the below information fields:

- Current tracklist
- Folder
- Select by cover
- Keyword Search
- Artists
- Albums
- Tracks
- Genres
- Year
- Composers
- Videos
- Photos

Devices

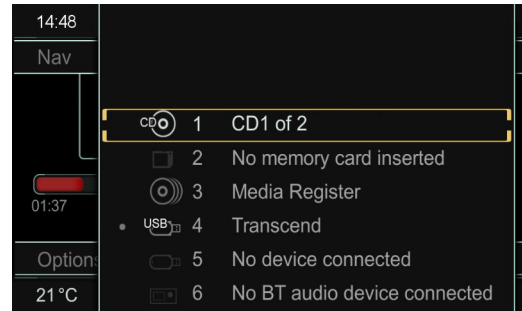

Opens a list of available media devices.

Sound

Opens the *Sound* menu screen (Refer to 'Sound', page 8.17).

Media Register

The media register can be used to store music, picture and video files directly on the vehicle's hard drive.

 Storage capacity for the media register is approximately 10.8 GB, enough to store approximately 10000 minutes (166 hours) of music, 4700 pictures or 1300 minutes (21 hours) of video¹.

Media Register Options

Select the *Manage Media Register* option in the **Options** menu. Choose from the following options:

- Rename/Delete Files
 - Edit
 - Delete
- Delete All Media Files
- Memory Info

Bluetooth Audio

Bluetooth Connection

 Bluetooth audio must be paired to the vehicle independently from the Bluetooth® hands free connection.

To select a Bluetooth audio device:

1. Make sure Bluetooth is activated on your device and in discoverable mode².
2. Select **Bluetooth Audio** as a media source.
3. In the **Options** menu, select **Bluetooth Audio Devices**.
4. Select a device from the list of available devices (previously paired devices will be shown with a tick symbol).
For new devices:
5. Select the device from the list to begin pairing.
6. A code will be shown on the infotainment display. If this code matches the code shown on the device select Yes to complete pairing.
Select *No* to cancel pairing the device.

¹. Values will depend on sound or picture quality.

². Refer to device manufacturers instructions.

Options

- Bluetooth Audio Devices
- Play mode
- Volume

Bluetooth Audio Devices

Opens menu to manage Bluetooth devices.

Play Mode

Select from *Normal Track Sequence*, *Random Track List* or *Random Media*.

Volume

Adjust volume of the vehicle speakers. Volume can also be controlled on the Bluetooth device. To maintain a volume level similar to other media sources, adjust the volume on the Bluetooth device before adjusting volume for the vehicle system.

Sound

The *Sound* menu screen can be accessed from either the *Radio* or *Media* screens.

- Equaliser
- Balance/Fader
- Surround
- Sound Field/Sound Focus

Equaliser

Adjust the **Treble**, **Mid-tones** and **Bass** frequencies between -10 and 10.

Balance Fader

Adjust the **Balance** (left to right) and **Fader** (front to rear) sound distribution between -10 and 10 (0 is equal distribution).

Surround (Bang & Olufsen only)

Adjust level for surround sound from -10 to 10.

Sound Field/Sound Focus

(Audio Level Dependent)

Changes the optimisation of the speakers depending on if how many occupants are in the vehicle. Select from:

- Auto:
Automatically adjusts the speaker focus for the number of occupants in the vehicle.

 *The media system detects occupants from which seat belts are engaged.*

- Driver:
The sound is optimised for the driver only.
- Front:
The sound is optimised for both the driver and front seat passenger.



ASTON MARTIN

Satellite Navigation

Safety Information	9.2
Navigation Controls.....	9.3
Navigation Menu.....	9.4
Options.....	9.4
Traffic	9.7
Route	9.8
Position	9.9
Destination	9.10
Navigation Menu.....	9.14

Safety Information

⚠ Warning: Failure to avoid the following potentially hazardous situations could result in an accident or collision resulting in death or serious injury.

⚠ Warning: Always use your best judgement, and operate the vehicle in a safe manner. Do not become distracted by the navigation system while driving, and always be fully aware of all driving conditions. Minimise the amount of time spent viewing the screen while driving and use voice prompts when possible.

⚠ Warning: Do not input destinations, change settings, or access any functions requiring prolonged use of the navigation system controls while driving. Bring the vehicle to a halt in a safe and legal manner before attempting such operations.

⚠ Warning: When navigating, carefully compare information shown on the screen to all available navigation sources, including road signs, road closures, road conditions, traffic congestion, weather conditions, and other factors that may affect safety while driving. For safety, always resolve any discrepancies before continuing navigation, and defer to posted road signs and road conditions.

⚠ Warning: The navigation software is designed to provide route suggestions. It is not a replacement for driver attentiveness and good judgement. Do not follow route suggestions if they suggest an unsafe or illegal manoeuvre or would place the vehicle in an unsafe situation.

Navigation Controls



Press the **NAV** (A) button or select **Nav** from the main menu to open the navigation screen.

Audio Controls



Use the left scroll wheel on the steering (B) to adjust the volume for navigation announcement. Press and hold the scroll wheel button during a navigation announcement to mute.

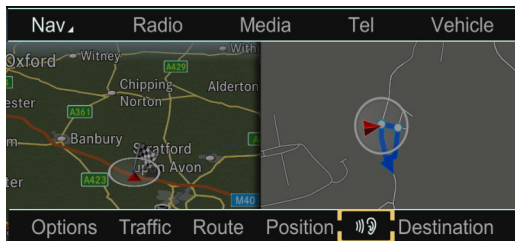

From the navigation menu select from the following options:

- **Options**
(Refer to 'Route Settings', page 9.4)
- **Traffic**
(Refer to 'Traffic', page 9.7)
- **Route**
(Refer to 'Route', page 9.8)(Only shown during route guidance)
- **Position**
(Refer to 'Position', page 9.9)
- **Repeat Announcement**
Repeat the last route guidance announcement. (Only shown during route guidance)
- **Destination**
(Refer to 'Destination', page 9.10)

Route Settings

Choose from the following route settings:

- **Fast Route**
Finds a route with the shortest journey time.
- **Dynamic Route**
Finds a route with the shortest journey time but updates with live traffic reports.¹
- **Eco Route**
Finds an economical route. Journey time may be increased compared to using Fast Route.
- **Short Route**
Finds a route with the shortest distance.

Calculate Alternative Routes

Switch to ON or OFF to provide alternative route calculations.

¹ Live Traffic information is not available in all markets.

Avoid Options

Select from the following options:

- **Avoid Area**

Select *Avoid New Area* and choose from:

- Using Map
- Address Entry

Or

Select a previous location

Push the **CONTROL DIAL** to the right to bring up the following options:

- Display/Change: Show and move the area to be avoided.
- Delete: Delete the current saved area.
- Delete All: delete all saved areas.
- **Avoid Motorways**
- **Avoid Ferries**
- **Avoid Motorail Trains**
- **Avoid Tunnels**
- **Avoid Unpaved Roads** (Market Specific)
- **Use Vignette Roads**₁(Market Specific)
- **Use Toll Roads**
 - Payment in Cash
 - Electronic Billing
 - Off

₁. Route calculation includes roads which require you to pay a time-based fee (vignette) which allows temporary use of the road network.

Map Orientation

Select to change the orientation of the display map. Select from:

- **North Up**

Map is displayed so that north is always up.

- **Heading Up**

Map is displayed so that the direction of travel is always up. The red tip of the compass shows north.

- **3-D Map**

Map is displayed so that the direction of travel is always up, and varying angles of elevation are shown depending on the immediate surrounding environment. The red tip of the compass shows north.

Map Content

Choose from the following map content options:

- **POI Symbols on Map**
 - **Standard Symbols:**
Shows default point of interest symbols.
 - **Personal Symbols:**
Search from a number of available points of interest to add to add to the map.
 - **No Symbols:**
Remove point of interest symbols from the map display.
- **Text Information on Map**
 - **Current Street:**
Street name is displayed at the bottom of the display.
 - **Geo-Coordinates:**
Show the longitude, latitude, elevation and number of satellites available at the bottom of the display.
 - **None:**
No information is displayed at the bottom of the display.
- **Motorway Information:**
Press to display the nearest services, rest areas and motorway junctions.
- **Next Intersecting Street:**
Shows the next crossroad or joining street at the upper edge of the display when route guidance is not active.
- **Map Version:**
Shows the map software data version.

Personal POIs

Load any saved personal points of interest from an SD Memory Card.

Settings

Choose from the following system settings:

- **Announce Street Names:**
Set to announce street names during changes of direction (Market Specific).
- **Audio Fadeout:**
Set to reduce the volume of media sources during a navigation announcement.
- **Audible Info During Phone Call:**
Set to enable or disable audible information during a phone call.
- **Reserve Fuel Level:**
Set to automatically search for a fuel station when the fuel tank reserve level is reached.

Traffic

Traffic Reports from FM RDS-TMC

An RDS-TMC radio station transmits traffic reports in addition to the radio programme. your vehicle can receive these reports and make adjustments to the route guidance. information received will be displayed in the bottom corner of the display and the symbol "TMC".

Traffic Menu

Select **Traffic** from the lower information bar to access the Traffic Menu.

Traffic Symbol Information

Shows a list of available traffic symbols for a traffic report. Select **Details** for a description of the incident and choose **Next** or **Previous** to display other incidents along the route.

Select **Map** to move the map. moving the map enables other traffic incidents to be shown.

Messages On The Route

Shows traffic reports along the route.

If there is more than one traffic report, they will be indicated by a page number. For example 1/3. Push the **CONTROL DIAL** left or right to scroll between reports.

Read Out All Message On Route

Select to read out traffic reports along the route. If there are no traffic reports this option will not be available.

To cancel the report being read, select *Cancel Read-Along Function*.



Note: The read-aloud function is interrupted automatically if the route is recalculated following a new traffic report.

Read Traffic Announcements Automatically

Select to automatically read aloud all traffic reports on route. Announcements are made automatically when approaching traffic incidents.

All Messages

Shows a list of all roads and areas affected by traffic reports. Roads and areas not on route also appear in the list. Select a location to display the traffic report.

Cancel Traffic Announcements

Press and hold the volume scroll wheel button on steering wheel during traffic announcements to set traffic announcements to off.

Route

Destination Information

Shows the destination and any intermediate destinations along with expected arrival time, distance and journey time.

Select a destination to view details. From the details screen you also have several options:

- **Call:** Call the destination if details are saved into your list of available contacts.
- **Map:** View the destination on the map.
- **Save:** Save the details to your contact book. Details can be saved as one of the following options:
 - **As New Contact:** Enter as a new contact in the contact book.
 - **Add to Contact:** Add address details to an existing contact in the contact book.
 - **As "My Address":** Set the address as your home address.
 - **To The Memory Card:** Save the address details to an SD memory card.

Alternative Route

Shows available alternative routes. Select **Previous** or **Next** to display alternative routes.

The current route is shown in light blue, and alternative routes are shown in dark blue. The most economical route is shown in green.

Select **Start** to start a new route.

Detour

Manually add an area to avoid on the route.

Select **Beginning** and press **ENTER**. Rotate the **CONTROL DIAL** to move through the route and press **ENTER** to set the beginning detour area.

Select **End** and repeat to set the end of the detour area.

Select **Start** to start a new route with the requested detour area.

Select **Delete** to delete the set detour.

Route List

Shows the route list as a turn-by-turn list of changes in direction along the route, with distance from the vehicle's position. Scroll through the list to show turns along the route on the map display.

Position

Save

Save the current position to the **From previous destination** list. Saved destination will have a symbol next to the location name.

POI Symbol Guide

Display information about any Points of Interest (POI)s in the immediate area.

Select **Previous** or **Next** to cycle POIs. Select **Details** to show details for that location or POI.

Details shown include the name of the location, address and road name. Push the **CONTROL DIAL** down to access the options for the detail screen. Choose from:

- **Map:** Return to map display screen.
- **Call:** Call the location if a phone number is available.
- **Save:** Save the details to your contact book. Details can be saved as one of the following options:
 - As New Contact: Enter as a new contact in the contact book.
 - Add to Contact: Add address details to an existing contact in the contact book.
 - As "My Address": Set the address as your home address.
 - To The Memory Card: Save the address details to an SD memory card.
- **Continue:** Choose **Set as intermediate destination** or **Cancel route guidance**.

3D Map Rotation

View the area around the vehicle in a 3D perspective. Rotate the **CONTROL DIAL** to change the direction of view or push the **CONTROL DIAL** to move the map cursor in that direction.

Where Am I?

Shows the current position. The street name is shown along with the previous turn and next turn in the route list.

 *If you are not on a recognised road, your position will be shown as geo-coordinates along with compass bearing.*

Destination

Cancel Route Guidance

Select to cancel current route guidance.

Address Entry

Select to open the address entry screen.

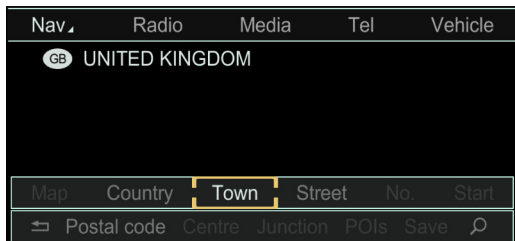

Enter information for:

- **Country**
- **Town**
- **Street**
- **Postal Code**
- **Keyword Search**

Once you have entered one of the above items of information you can filter your search further by adding more information to the above or entering one of the following:

- **Centre:** Centres search of a town or post code area.
- **Junction:** List streets that connect to the chosen street.
- **No.:** Enter a house number.
- **POIs:** Lists local points of interest by category.
- **Save:** Save the details to your contact book. Details can be saved as one of the following options:
 - **As New Contact:** Enter as a new contact in the contact book.
 - **Add to Contact:** Add address details to an existing contact in the contact book.
 - **As "My Address":** Set the address as your home address.
 - **To The Memory Card:** Save the address details to an SD memory card.
- **Start/Continue:** Select to begin route guidance. If you have selected *CALCULATE ALTERNATIVE ROUTES* a list available routes are shown (Refer to 'Alternative Route', page 9.8).

Keyword Search

Keyword search can be used to find a location without having to enter the full name. Search also allows for spelling mistakes and fragments of words. Town and street names can be searched for at the same time by separating with .

For example: LON REGE can find Regent Street in London. Whilst entering letters into the search field, the results field will update to show the number of exact and approximate matches. Results are shown in the format (XXX/YYY) where XXX are the number of exact matches to your search and YYY are the number of approximate matches.

Once a location, or part of a location, has been entered the following results are shown:

- Addresses.
- POIs in the vicinity.
- All POIs.
- List Search.

 *A value of 999+ is displayed if there are too many results to display.*

Addresses

Shows a list of both exact and approximate addresses that match your search terms. Exact matches are shown at the top of the list in alphabetical order. The search terms used are shown highlighted in the results. Scroll through the results to make a selection. The *Address Entry* screen (Refer to 'Address Entry', page 9.10) will then be shown with fields populated. Select **Start** to begin route guidance.

POIs in the Vicinity

Shows a list of points of interest that match the search terms. Results are shown in order of distance from your current location.

All POIs

Shows a list of both exact and approximate points of interest that match your search terms. Exact matches are shown at the top of the list in alphabetical order. The search terms used are shown highlighted in the results.

From Previous Destinations

Search from a list of previously entered addresses. Scroll through the list of available locations and press **ENTER** to select a destination from the list. Push the **CONTROL DIAL** right to view the following options:

- **Details:** Press **ENTER** to view a list of details for that destination.
- **Delete:** Press **ENTER** to delete the selected destination.
- **Delete All:** Press **ENTER** to delete all previous destinations.

From Contacts

Search from a list of contacts stored on a mobile phone contact list. Contacts that can be selected for route guidance will be shown with a compass symbol next to the contact entry. If a **MY ADDRESS** entry has been saved this can be accessed even if no mobile phone is connected to the vehicle.

Scroll through the list of available locations and press **ENTER** to select a destination from the list or push the **CONTROL DIAL** right to view the following options:

- **Details:** View a list of details for that destination.
- **Select From Contacts:** Select entry from the contacts list.
- **Delete Entry:** Delete the selected destination.

From POI

Select to choose a location based on a point of interest.

Near Destination

(Only available while route guidance is active)

Choose a point of interest near your destination.

Current Position

Choose a point of interest near your current location.

Other Town

Choose a point of interest based on another town.

 Only **TOWN** or **COUNTRY** will be available as list to select a location from.

Search By Name

Search by name for all points of interest on the map, or based on one of the above search locations.

Search By Phone Number

Search all points of interest that have a phone number listed. Search results can be filtered by entering phone numbers.

 All phone numbers are preceded by a two digit country code. For example +44 for phone numbers in Great Britain.

Using Map

Find a destination using the map display. Move the cursor by pushing the **CONTROL DIAL** in the chosen direction. Rotate the **CONTROL DIAL** clockwise to zoom out and counter-clockwise to zoom in. Once you have chosen a destination, press **ENTER**. The *Address entry* screen will then be shown with relevant fields populated. Select **Start** to begin route guidance.

Intermediate Destinations

Select to show any intermediate destinations added to your route. Scroll through the list of intermediate destinations and press **ENTER** to view the following options:

- **Edit:** Edit what point of interest should be in the selected slot in the list of destinations.
- **Move:** Move what slot in the list the selected item is.
- **Delete:** Delete the selected intermediate destination.

To add a new intermediate destination, scroll to an empty slot in the route list and press **ENTER** where **Add new** is displayed.

Select a point of interest from the list and all available locations along your route will be shown at the top of the list. All available locations in the vicinity will be shown at the bottom. Press **ENTER** to select a location and the *Details* screen will be shown.

From Memory Card

Load a saved route from a SD memory card.



This function is only available if a SD Memory card with route data is inserted into the SD card slot.

Using Geo-Coordinates

Select to enter a destination using geo-coordinates. Rotate the **CONTROL DIAL** to increase or decrease the values, and push the **CONTROL DIAL** left or right to change between degrees, minutes, seconds and bearing. Push the **CONTROL DIAL** up or down to switch between latitude or longitude.

Once a destination has been entered, select **Start Route Guidance** to begin route guidance or select **Save** to save the destination to your contact book. The destination can be saved as one of the following options:

- **As New Contact:** Enter as a new contact in the contact book.
- **Add to Contact:** Add address details to an existing contact in the contact book.
- **As "My Address":** Set the address as your home address.
- **To The Memory Card:** Save the address details to an SD memory card.

Navigation Menu

From the navigation display press the **NAV** button, or push the joystick up, to access the main vehicle menu and navigate to **Nav** to open the navigation menu.

In the navigation menu you will be shown the options that follow:

- **Navigation:** Returns to the navigation display.
- **Compass:** Show compass direction as well as current geo-coordinates. Select **Compass on the map** to overlay the compass on the map display screen.
- **Qibla:** Shows a compass giving the direction of prayer to Mecca. (Market Specific)
- **Drive Information:** Cycles through information about the journey such as the destination location, distance remaining, distance to next intermediate destination and estimated arrival time.
- **Route Flight:** Shows an animated visualisation of the set route guidance. Select **Play** to begin visualisation. Select **Pause** to pause play through, and **Stop** to end play through and return to the start location.



ASTON MARTIN

Vehicle Settings

Vehicle Settings.....	10.2
Time Settings.....	10.2
System Settings.....	10.3

Vehicle Settings

Acoustic Lock Feedback

Set audible lock note on or off.

Auto-Fold Mirror

Set if mirrors are folded when vehicle is locked to on or off.

Locator Illumination

Set locator illumination on or off.

Automatic Locking Feature

Set the automatic locking to on or off.

Exterior Light Delay

Select time delay for main lights when headlamps switched on with ignition off.

Tow Away Protection

Set tow away tilt sensor on or off.

Interior Motion Sensor

Set interior motion sensors to on or off.

Ambient Light Brightness

Select brightness level for ambient lighting.

Easy Entry/Exit

Set steering wheel easy entry feature on or off.

Time Settings

Automatic Time Settings

Select to set automatic time settings to on or off.

Time Zone

Select the required local time zone. For example, London GMT.

Once a time zone has been selected, the *Summer Time* menu will open to allow adjustment for summer time settings.¹

Summer Time

Set summer time adjustment to *Automatic, On or Off*.

Set Time Manually

Opens a graphical interface that allows the time to be set manually using the rotary joystick.

Format

Use to set the format for date and time.

¹. Not available for all time zones.

System Settings

Favorite Functions

When *Favorite Functions* is selected the below menu options are available. Use the joystick to select:

- Navigation
- Radio
- Media
- Vehicle
- Climate Control On/Off
- A/C On/Off

Press **ENTER** on a menu item to access the following options for that item:

- Reassign
- Rename
- Move
- Delete

Display

Select *Display* to access the display settings options:

- **Day**
Brighter display colours for clearer viewing during daytime driving conditions.
- **Night**
Dark display colours to reduce glare when driving at night.
- **Automatic**
Automatically change between day and night display when conditions change.
- **Brightness**
Change the level of display brightness between -5 and +5.

Language

Select the language for the vehicle infotainment system from one of the available languages.

Voice Control

- Help Window
- Start New Individualisation
- Delete Individualisation
- Individualisation ON

Text Reader Speed

Select to choose a text reader speed from *Fast*, *Medium* or *Slow*.

360° Camera

Select to choose between activation by *R Gear* or *Object Detection*.

Touchpad

Select to set *Activate Touchpad* or *Read Out Handwriting Recognition* to on or off.

Activate Bluetooth

Select to set Bluetooth to on or off.

Automatic Volume Adjust

Select to set automatic volume adjust to on or off.

Import/Export Data

Select to import or export data such as vehicle settings or navigation data, to a portable media device such as a USB device or SD card. This data can then be used to transfer to another vehicle or to load settings after disconnecting a battery.

Reset

Select to restore all default settings.

Convertible Roof

Roof Operation	11.2
Roll-Over Protection System.....	11.4
Wind Deflector	11.6
Emergency Roof operation	11.8

Roof Operation

⚠ Warning: Before raising or lowering the roof, make sure that all occupants are clear of the tonneau panel, the windscreen frame and door windows.

⚠ Warning: Misuse of the roof switch, especially by children, can result in injury due to entrapment in the roof mechanism and locking points.

⚠ Caution: Aston Martin recommend that the roof is not operated at temperatures of 0°C and below.

⚠ Caution: Make sure that the roof is always fully raised or fully lowered.

⚠ Caution: Do not attempt to lower the roof if any objects or clothing are laying on top of the roof or tonneau panel.

⚠ Caution: Before closing or opening the roof, make sure that there are no objects placed on the rear sloping deck area which could interfere with the folded, stored roof, especially the heated rear windscreen glass. Even small objects can cause damage.

⚠ Caution: Continuous use of the roof without the engine operating will cause the vehicle battery to rapidly discharge.

To Operate The Roof

⚠ Warning: Keep the vehicle road speed down to a minimum until the roof has completed its operation.

⚠ Caution: Aston Martin recommend that the roof is only operated while the vehicle is stationary and that the engine is always running when operating the roof mechanism to maintain optimal battery performance..

 The deck lid will lock and will stay locked during roof lowering and raising operations.

Before operating the convertible roof:

- The deck lid must be closed.
- The ignition must be on and the engine must be running.
- Outside temperature must be above -10°C.
- The variable load device must be in the lower position.
- A maximum headroom (A) of 1795 mm is available for the roof to raise or lower.

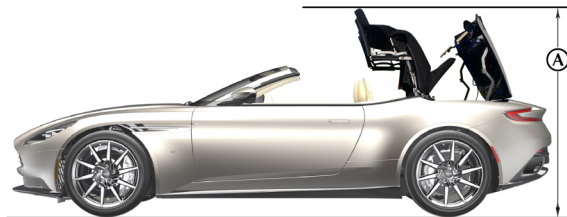

Operation

⚠ Warning: If roof movement is not complete the message "Open/close top completely" will be shown in the instrument cluster.

To operate the roof use the switch (B) in the centre console.

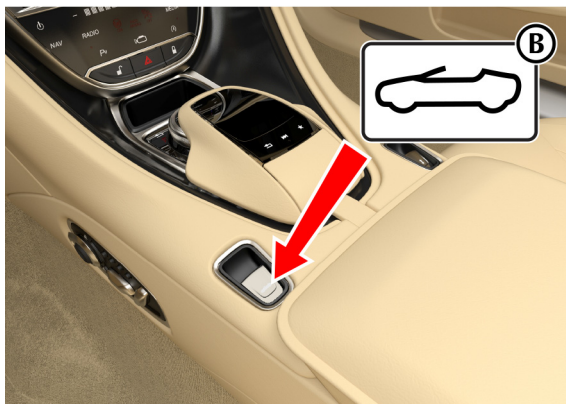

To Lower the Roof: Pull and hold the switch backwards to lower the roof.

To Raise the Roof: Push and hold the switch forwards to raise the roof.

Once roof movement is complete, a confirmation sound will be heard from the instrument cluster.

Window Operation

The windows can be lowered and raised independently of the roof. When the roof is fully lowered or raised use the window switch to operate the windows as normal.

Roof Relaxation

The roof system continually monitors the roof position. If the roof is in a position between fully open and fully closed for 7 minutes with the ignition on, the roof will close. There will be a warning sound and the roof will relax and close to its stowage position in its lowest position.

🔑 If the key is removed from the vehicle ignition, the roof system will not wait the 7 minutes and will close after the audible warning.

⚠ Warning: The roof can fall rapidly as the roof system loses hydraulic pressure. Keep away from the roof mechanism when the audible warning begins, to prevent injury or entrapment.

Roll-Over Protection System

Over-speed Operation

Vehicle speed should be below 55 km/h (34 mph) when the roof is operated.

If the vehicle speed exceeds 55 km/h (34 mph), the convertible roof will stop opening or closing. This can restrict the view from the rear of the vehicle and can cause an accident. Reduce the vehicle speed to below 50 km/h (31 mph). Press the roof switch again to continue roof operation.

When safe to do so, continue the roof movement. If the roof is left in it's paused position for seven minutes, hydraulic pressure will be lost in the roof mechanism. The roof and tonneau lid will relax and drop down.

⚠ Warning: Do not attempt to service or modify the deployable roll-bar system.

⚠ Warning: Do not allow any person to sit on the deployable roll-bar covers at any time.

⚠ Warning: Do not place any objects on the top of the deployable roll-bar covers.

⚠ Warning: Do not attempt to reset the deployable roll-bar system after it has deployed.

⚠ Warning: Do not attempt to raise or lower the roof after the deployable roll-bar system has deployed.

⚠ Caution: If the roof is raised the deployable roll-bars will break through the rear glass.

⚠ Caution: Extreme manoeuvres may cause the vehicle system to predict a roll-over event and activate the roll-over protection system. If such driving is anticipated by the customer (track day driving, for example) the roof should be fully lowered so the roll-bars can be deployed without damaging the vehicle.

The roll-over protection system has electronic sensors mounted to the vehicle body that monitor and determine if a roll-over has taken place. If the system senses a rollover, two roll bars mounted under trim panels in the tonneau lid, will deploy to protect vehicle occupants.

 *If the roll-bars are deployed the door mounted airbags will also be deployed to further protect vehicle occupants.*



Warning Labels

Do Not Cover is embossed into tonneau cover above the roll bars.

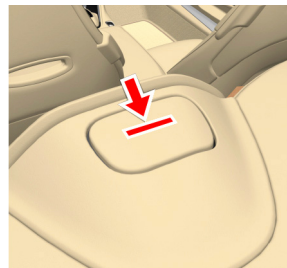

Wind Deflector

The wind deflector can be used to greatly reduce wind turbulence when the roof is lowered. It is easily installed to mounts in the vehicle and can be left in place with the roof raised or lowered.

⚠ Caution: Take care when adjusting the driver or passenger seat position with the wind deflector installed. Make sure that the seats do not come into contact with the wind deflector.

Storage

The wind deflector can easily be folded and stowed away when not used. When the wind deflector is not required, remove it from the vehicle and place it in the storage bag. Place the storage bag in the vehicle luggage compartment.

Installation

To install the wind deflector:

1. Remove the wind deflector from the storage bag.
2. Unfold the base panels.



3. Open the main net panel and join the two base panels with the snap connectors.

⚠ Caution: Do not try to join the base panels with the snap connector before folding down from their stored position. If you do, you will damage the snap connectors.

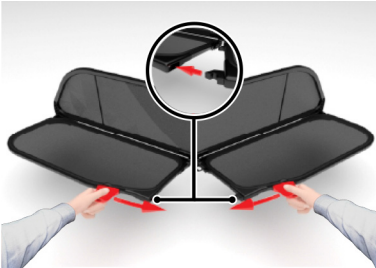

4. Insert the two locating tabs into the rear seat belt openings. Use the two slide bolts to lock the wind deflector above the rear seats.

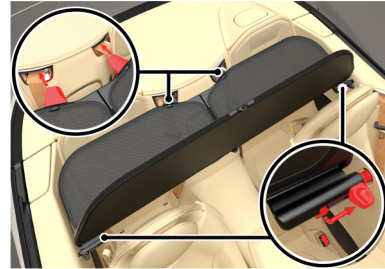

Emergency Roof operation

When the wind deflector is installed it can be used in the raised or lowered position. Grab the top bar of the wind deflector to raise or lower the panel until it clicks into position.

⚠ Caution: Do not use the wind deflector to store items. This can cause damage to the wind deflector such as a rip in the net area.

⚠ Caution: Do not grab the main net panel. Sharp objects can pierce or otherwise damage the net.



Removal

To remove the wind deflector, do the installation procedure in reverse.

In the unlikely event of the roof failing, it can be manually raised and locked.

⚠ Warning: Make sure the ignition is set to off before you begin this procedure. This will prevent accidental operation of the roof which can cause injury.

⚠ Warning: Aston Martin recommend that a minimum of two people are required to manually raise and lock the roof. The roof mechanism will move very slowly when being raised manually.

⚠ Warning: Keep fingers clear of the roof linkage when moving the roof manually.

⚠ Caution: Vehicle Security: If the roof fails, always raise and lock the roof. Do not lower the roof as tonneau lid locks will not be available.

📖 If the roof fails in the stored position it can stay stored and locked if required. Contact your Aston Martin Dealer.

📖 If the roof fails after the tonneau locks have been released the message "Open/close top completely" will show in the instrument cluster and a continuous audible warning will sound until the roof has been locked in the raised position.

To Raise the Roof

 Once the manual roof raise procedure is complete, you will not be able to operate the convertible roof until it has been reset by an Aston Martin Dealer.

1. Remove the wind deflector (if installed).
2. Remove the head rests (A) for the rear seats.

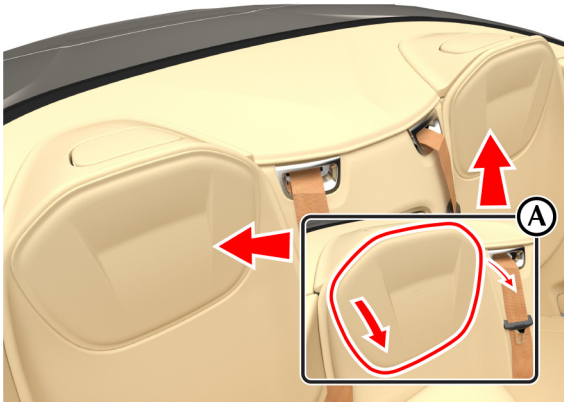

3. Remove the roof emergency tool (B) and put to one side. This will be needed to lock the roof.

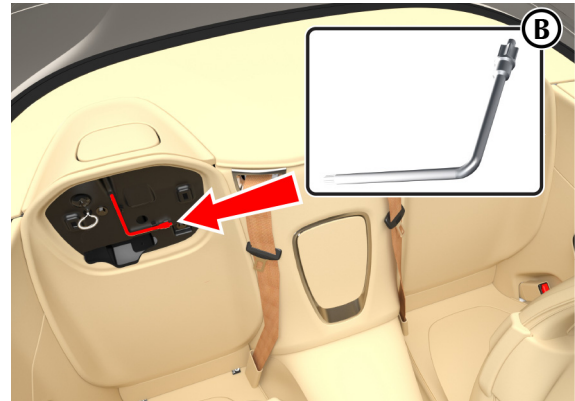

4. Pull the two release cables (C) for the tonneau latches.



5. Lift the tonneau cover at the points shown.

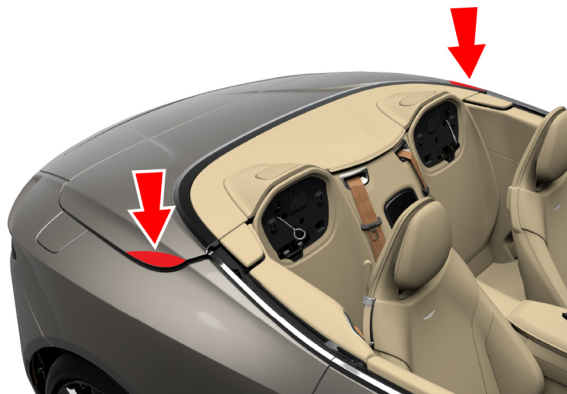

6. Push the hinge pivot (D) rearward to lock the tonneau into position.

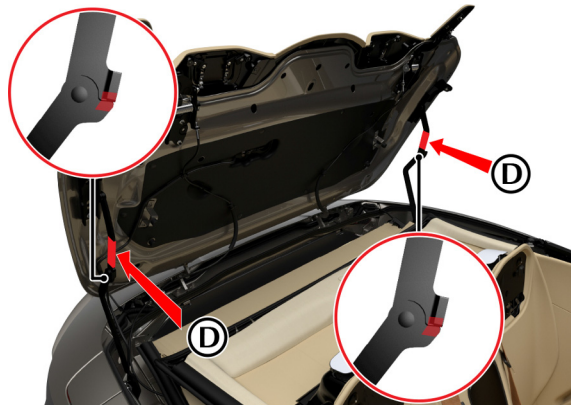

7. With a person each side, support the tension bow (E) and fully lift the roof to its closed position.

⚠ Caution: The tension bow must not be allowed to fall until the front latches for the roof are in their receivers. If the tension bow does fall back before this point, the inner lining for the roof will be damaged.

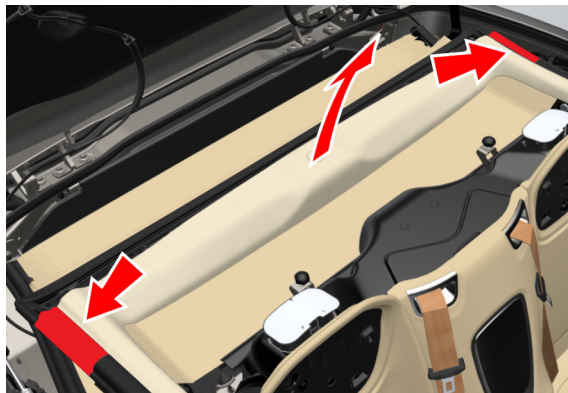

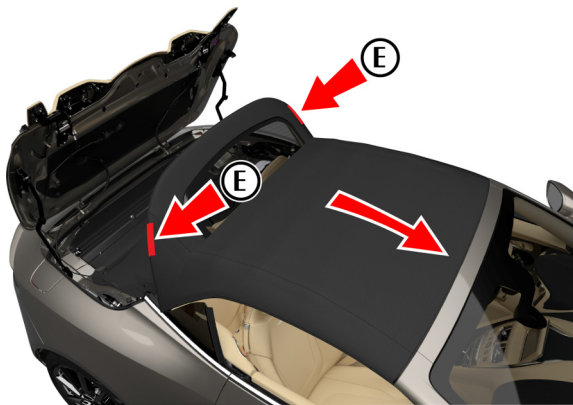

8. Whilst supporting the tension bow, unlock the hinge and close the tonneau cover.

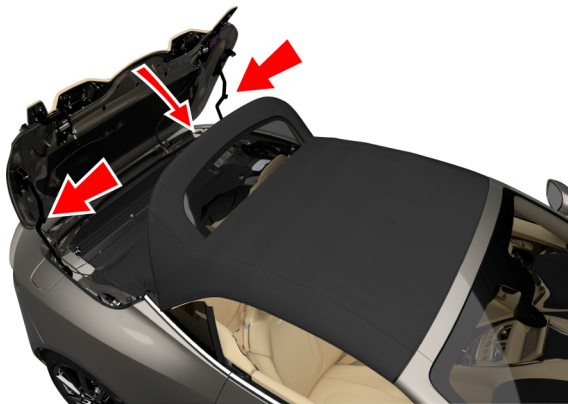

9. Once the tonneau cover is fully closed, lower the tension bow.

⚠ Caution: *Do not allow the tonneau lid to rest on the roof fabric.*



10. Inside the vehicle, remove the trim plug from the front header panel.



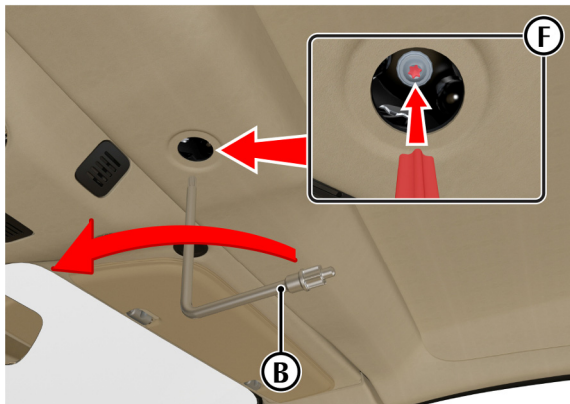

11. Use the small end of the roof emergency tool to remove the screw (F) from the roof motor.

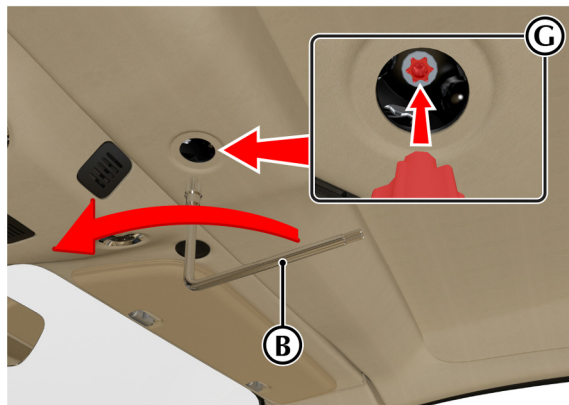

12. Use the large end of the roof emergency tool to disengage the drive spline (G) and turn the motor one turn counter-clockwise.

 You must contact your Aston Martin dealer to reset the drive to the roof latch motor.



 If the roof is manually raised or lowered, both the tension bow and the tonneau cover cannot be locked.

Maintenance and Technical Data

Introduction	12.2
Servicing Precautions.....	12.3
Owner Maintenance Checks	12.5
Bonnet Release	12.7
Fluid Checks and Capacities	12.8
Washers and Wipers	12.13
Chassis Systems	12.14
Wheels and Tyres.....	12.15
Electrical Systems	12.19
Vehicle Care	12.34
Powertrain Specifications.....	12.39
Performance	12.42
Dimensions	12.43
Emergency and Breakdown	12.46
Fuel.....	12.53

Introduction

Due to the sophistication of the various systems and the specialised equipment required to maintain this vehicle, owner maintenance should be restricted to the routine procedures described in this chapter.

If you think that this vehicle is not functioning correctly, please contact an Aston Martin Dealer for the vehicle to be professionally checked.

Parts and Lubricants

Aston Martin recommends that when performing a servicing task, the recommended lubricants (Refer to 'Fluid Specifications', page 12.11) and parts are used.

⚠ Caution: If oils or lubricants are used which do not meet the required fluid specification, vehicle components may experience excessive wear, a build-up of sludge and deposits or cause increased pollution. If it is evident to Aston Martin that use of products other than those which are recommended by the manufacturer have caused damage to the vehicle or engine, Aston Martin may refuse to authorise the repair of such damage under the terms of the manufacturer's warranty.

Electronic Fuel Injection

⚠ Warning: If the fuel system is allowed to run dry, the fuel pump(s) can be permanently damaged.

⚠ Warning: Any modifications or additions to the fuel system not specifically designed by Aston Martin are prohibited. If installed, they can cause damage to the fuel system which, in some circumstances, could cause fire. All Service Action and Safety Recall Actions must be undertaken by an Aston Martin Dealer.

The electronic fuel injection system requires specialist equipment and test facilities to set up and maintain so that the vehicle gives maximum performance, coupled with economy, reliability and safe vehicle emissions. You are, therefore, strongly advised to entrust all service work to an Aston Martin Dealer.

Restraint Systems

Aston Martin recommend that the inflatable restraint systems (airbags) and seat belt components installed to this vehicle are replaced at 10 year intervals from the date of manufacture on the certification label.

Servicing Precautions

To avoid personal injury, the following safety precautions must be observed when the bonnet is open and the engine is operating or the ignition is on.

⚠ Warning: Protect yourself against dangerous substances.

⚠ Warning: Keep hands, hair, tools, items of clothing and jewellery clear of all drive belts, pulleys and operating mechanisms. The cooling fan may operate even though the engine is not operating.

⚠ Warning: Avoid skin contact with all exhaust system and engine components, engine fluids and escaping steam. They may be hot and can cause scalding or burns.

⚠ Warning: Any loose objects, such as ties, should be removed before working on a vehicle. Any jewellery should also be removed before working on a vehicle, especially work on the electrical system.

⚠ Warning: Catalytic converters convert harmful exhaust gasses into less noxious substances and so reduce environmental pollution. They operate at high temperatures and continue to radiate a considerable amount of heat after the ignition has been set to off.

⚠ Warning: Do not breathe exhaust fumes. Exhaust fumes contain carbon monoxide. Carbon monoxide is a dangerous gas, which is colourless and odourless and can cause unconsciousness and may be fatal. Never start or leave the engine running in an enclosed, unventilated area.

⚠ Warning: Do not work beneath the vehicle with a vehicle lifting jack as the only support. Place suitable stands under the vehicle.

⚠ Warning: Keep children and pets clear of the vehicle. Do not let anyone inside the vehicle unless specifically working to your instructions.

⚠ Warning: Whenever possible, work in the engine compartment with the engine cool, the ignition off and the vehicle battery disconnected.

⚠ Warning: Petrol is highly flammable and, in confined spaces, is also explosive and toxic. In the event of spillage, set the engine to off. Do not use a flame or spark near fuel or fuel vapour. Do not smoke near fuel or fuel vapour. Do not inhale fuel vapour or fumes.

Dangerous Substances

⚠ Warning: *Dangerous substances should be kept out of reach of children.*

⚠ Warning: *Many liquids and other substances used in motor vehicles are poisonous and should under no circumstances be consumed and should, so far as possible, be kept from contact with the skin. These substances include battery electrolyte, antifreeze, oil, brake and clutch fluid, petrol, windscreen washer additives, lubricants, refrigerant and various adhesives.*

⚠ Warning: *Particular care should be taken to avoid unnecessary contact with used engine oil. Always read carefully the instructions printed on labels or stamped on components and follow them carefully. Such instructions are included for reasons of your health and personal safety. Never disregard them.*

Engine Oils

⚠ Warning: *Prolonged and repeated contact with used engine oils can cause serious skin disorders, including dermatitis and cancer. Avoid excessive contact, wash thoroughly after contact. Keep out of reach of children. When your oil is changed, be sure that it is done by an experienced person. In addition, observe all laws regarding the disposal of waste oil and toxic fluids.*

Protect The Environment

⚠ Warning: *It is illegal to pollute drains, water courses, or soil. Use authorised waste disposal facilities, including civic amenity sites and garages providing facilities for receipt of used oil. If in doubt, contact your local authority for advice.*

Owner Maintenance Checks

In the interests of safety and reliability, it is advisable to carry out the following checks at the intervals suggested (more frequently if your vehicle is heavily used or operating in adverse conditions), and always before starting on a long journey. Refer to the following pages for advice and check procedures.

Before Use Check:

- Operation of lamps, horn, indicators, wipers, washers and warning symbols
- Check there is sufficient fuel for the intended journey, particularly at night and before entering motorways
- Operation of the seat belts
- Operation of the brakes
- Check for fluid deposits underneath the vehicle.

Weekly Checks

(daily if driving large distances or touring)

- Tyre condition
- Coolant level
- Brake fluid level
- Air conditioning operation
- Windscreen washer fluid level
- Check operation of windscreen washers.

Fuel Filler Bowl

During fuel filling check that the fuel filler bowl drain pipe is free from debris which may block the pipe. If the pipe is blocked, water can not drain from the bowl and can overflow into the fuel tank.

Engine Oil Level

⚠ Caution: *It is important to check the engine oil level regularly. Running the engine with engine oil below the lower mark or above the upper mark can cause serious engine damage.*

Check the engine oil level every fourth fuel tank fill or weekly - whichever ever is the sooner .

Tool Kit

The following emergency items are located in stowage box tool kit in the luggage compartment.

- First aid kit (optional).
- Warning triangle.
- Tyre repair kit which also holds:
 - Towing eye
 - Funnel for emergency fuel fill
 - Locking wheel bolt key (optional)

Aeroblade Filter

Coupe Only

Over time it may become necessary to clean the filter traps for the Aeroblade ducts.

- Press the release tab (1) down to unlatch the filter trap.

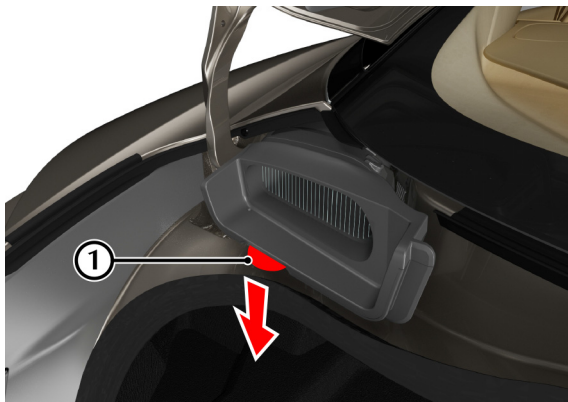

- Remove the filter trap (2) from the aeroblade duct. Clean the filter and remove any obstructions such as leaves.

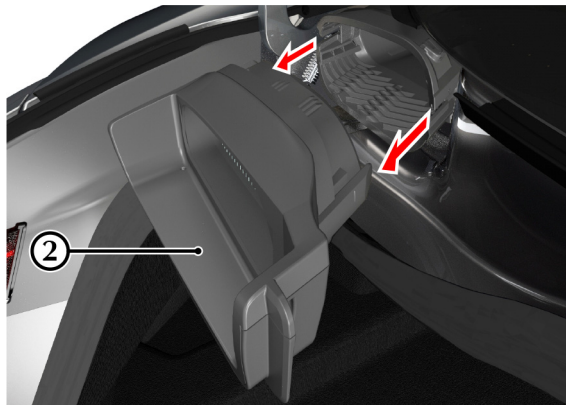

- Slide the filter trap back into the aeroblade duct making sure the guides engage correctly.

Bonnet Release

To open the bonnet press the button (A) located on the end of the instrument panel to release the bonnet latches.

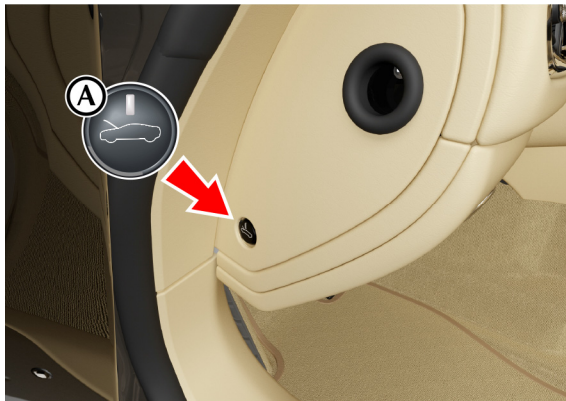

 *The bonnet release button is always on the driver's end of the instrument panel and changes with hand of drive.*

Lift on the rear edges of the bonnet and pull upward and lift until fully open. The bonnet is then held open by two gas struts.

To close the bonnet, lower the bonnet until it starts to fall under its own weight. At that point let the bonnet fall to close. If the bonnet does not shut, open the bonnet again and repeat the closure procedure, this time assist using light hand pressure as the bonnet falls.

Emergency Bonnet Release

In the unlikely event that either the bonnet release switch fails to operate or the vehicle battery is fully discharged there are two manual release cables (A) located either side of the instrument panel.

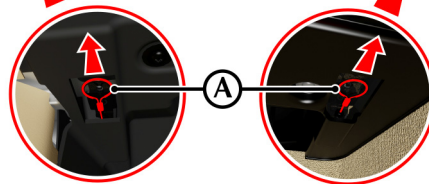

Pull both cables to release the latches for the bonnet.

Fluid Checks and Capacities

⚠ Warning: Engine components may be hot and could cause severe burns.

V12 Engine

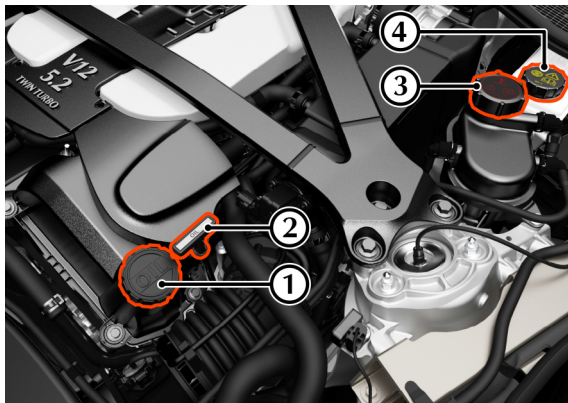

- [1] : Engine oil filler cap.
- [2] : Engine oil dipstick.
- [3] : Engine coolant reservoir.
- [4] : Brake fluid reservoir ¹.

¹. Changes sides for left and right hand drive.

V8 Engine

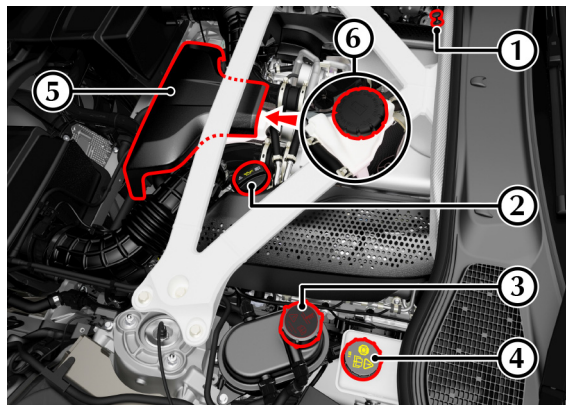



- [1] : Engine oil dipstick.
- [2] : Engine oil filler cap.
- [3] : Engine coolant reservoir.
- [4] : Brake fluid reservoir ¹.
- [5] : Forward engine cover
- [6] : Charge-cooler coolant reservoir (under [5])².

². The charge-cooler system should only require checking by your Aston Martin Dealer during regular vehicle services.

Engine Oil Level

 **Warning:** Engine oil or components may be hot and could cause severe burns.

 **Caution:** Running the engine with engine oil below the lower mark or above the upper mark can cause serious engine damage.

 **Caution:** This vehicle's warranty may be invalidated if damage is caused by the use of incorrect engine oil. Low quality or obsolete oils do NOT give the protection required by modern, high performance engines.

 **Caution:** Failure to use engine oil that meets the required specification can cause excessive engine wear, a build up of sludge and deposits, and increased pollution. It could also lead to engine failure (Refer to 'Fluid Specifications', page 12.11).

Engine Oil Level Check:

- The vehicle should be on level ground.
 - Check the engine oil level every fourth fuel tank fill or weekly - whichever is the sooner.
1. Run the engine until it reaches normal operating temperature.
 2. Turn the engine off and wait 15 minutes to allow the engine oil level to become stable.
 3. Withdraw and wipe the dipstick clean using a lint free cloth.
 4. Fully insert the dipstick into the dipstick tube with the Min. and Max. marking on the blade upwards (facing towards the engine). Withdraw the dipstick again.
 5. The engine oil level should read between the Min. and Max. marks.
 6. Put the dipstick back into the dipstick tube.
 7. If required, remove the engine oil filler cap and top up the engine oil with the recommended engine oil.

 **V12 engine:** Approximately two litres are required to bring the oil level from Min. to Max.

V8 engine: Approximately one and a half litres are required to bring the oil level from Min. to Max.

8. Wait for approximately two minutes for the engine oil to settle, then repeat steps 3 to 6. Add engine oil if required.
Do not overfill.
9. Securely fit the engine oil filler cap.

Engine Oil Level Sensing

⚠ Caution: *The electronic engine oil level sensing system does not replace the need for the owner to regularly check the engine oil using the dipstick. Check the engine oil level every fourth fuel tank fill or weekly - whichever is the soonest.*

This vehicle has an electronic engine Oil Level Sensing (OLS) system which records the engine oil level every vehicle start if the vehicle has been left for 4 or more hours, if the vehicle is on level ground, and if it is within a pre-set oil temperature range.

⚠ Caution: *Running the engine with engine oil below the minimum mark on the dipstick can cause serious engine damage.*

 *The system may not record an oil level if the engine oil temperature is low.*

For the correct engine oil (Refer to 'Fluid Specifications', page 12.11).

If the engine oil level is approaching the minimum mark the message OIL LEVEL WARNING CHECK AND TOP UP will show in the message centre along with an amber warning triangle and a chime sound. A code will also be stored in the engine management system. The engine oil level is low and should be checked and filled to the required level engine oil as soon as possible. The message will clear when the oil level is filled with at least 1 litre to the required level and the OLS system has performed a valid check of the oil level.

Engine Coolant Level

⚠ Warning: *Do not remove the filler cap until the coolant system has cooled. Scalding can be caused by escaping steam or coolant.*

 *Use a cloth or glove to protect hands and protect face and arms adequately.*

1. Remove the reservoir cap to check the coolant level. The correct coolant level is to the top of the reservoir tank.



2. Make sure that the reservoir cap is secure after topping up.

⚠ Caution: *Do not over tighten the reservoir cap. This can cause damage to the reservoir cap or the thread for the reservoir tank.*

Brake Fluid Level

⚠ Warning: Do not drive the vehicle if the brake fluid level is below the minimum mark.

⚠ Caution: Make sure that the brake fluid does not contact the paint work during the topping up operation. Serious paint work damage can result. If a spillage does occur, immediately flush any brake fluid from the paint work with clean, fresh water and then wipe with a clean damp cloth.

The brake fluid level should read between the Min. and Max. marks.

1. Remove the reservoir cap. Top up to the Max. level.

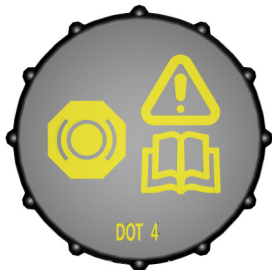

2. Install the reservoir cap securely.

Fluid Specifications

Fuel

Minimum 95 RON unleaded fuel.

Recommended 98 RON Super unleaded for optimum performance.

Use of fuel with more than 10% ethanol is not permitted.



Engine Oil

⚠ Caution: To achieve the required high performance of synthetic lubricants, do not mix with mineral oils.

V12 Engine

A fully synthetic 0W-20 oil meeting the specifications detailed below can be used. No other viscosity grades or specifications are acceptable.

Authority	Standard
API	SN
ILSAC	GF5

V8 Engine

A fully synthetic 0W-40 oil meeting the specifications detailed below can be used. No other viscosity grades or specifications are acceptable.

Authority	Standard
API	SN
ILSAC	GF5

Engine Coolant

Contact your Aston Martin Dealer for information on engine coolant.

Brake Fluid

DOT 4

Air Conditioning Refrigerant

! Caution: Refrigerant gas types must not be mixed. If you do, the air conditioning system can be damaged. If in doubt, consult your Aston Martin Dealer.

HFC134A / HFO-1234yf₁

Capacities

	V12	V8
Fuel Tank (Max/Usable)	80/75 Litres	
Engine Oil (including filter)	10.8 Litres	8.5 Litres
Engine Coolant (includes transmission cooling)	29.7 Litres	18.6 Litres
Charge Cooler Coolant	N/A	6.7 Litres
Automatic Gearbox (including cooler)	8.5 Litres	
Automatic Transmission Differential	1.1 Litres	
Screen Washer Reservoir	4.0 Litres	

¹. Market dependent

Washers and Wipers

Windscreen Wash Fluid

To refill the washer fluid, open the washer fluid reservoir cap (A) and top up as required. In winter, to prevent the windscreen wash fluid freezing, increase the fluid concentration (refer to the manufacturers recommendations on the windscreen wash fluid container).



When the level of windscreen wash fluid is low an information message will show in the message centre and the amber warning symbol will come ON.

Local or state regulations may restrict the use of volatile organic compounds (VOCs), which are commonly used as antifreeze agents in windscreen washer fluid. A windscreen washer fluid with limited VOC content should be used only if it provides adequate freeze resistance for all regions and climates in which the vehicle will be operated.

Wiper Blade Replacement

To remove a wiper blade, lift the wiper arm and press at point (B) to release the wiper blade.

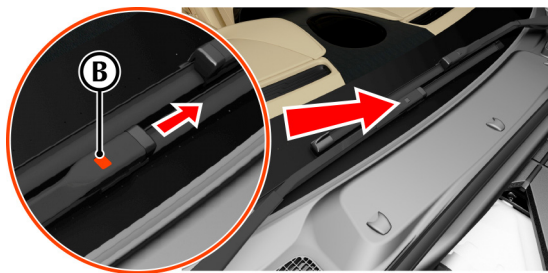

Slide a new wiper blade on to the wiper arm until it locks into place.

Chassis Systems

Vehicle Body

Two door coupe with 2+2 seating.

Two door convertible with 2+2 seating.

- Extruded aluminium bonded monocoque body structure.
- Curlicue front and Aston Martin AeroBlade rear integrated aerodynamics.
- Deployable spoiler.

Steering

Electrically assisted, speed sensitive rack and pinion power steering. Column adjustment for reach and tilt.

Turns Lock to Lock

2.375 turns.

Turning Circle

11.75 m.

Suspension

Front

Independent double aluminium wishbone incorporating anti-dive geometry. Coil over aluminium monotube dampers and anti-roll bar.

Rear

Multi-link suspension with hollow-cast lower control arms and hot-forged aluminium link arms. Coil over aluminium monotube dampers and anti-roll bar.

Brakes

Foot Brake

	Front	Rear
Disc Construction	2-piece ventilated disc	Combination cast ventilated disc
Diameter	400 mm	360 mm
Calipers	Six Piston	Four Piston

Park Brake

Electrically operated independent park brake calipers on each rear brake disc.

Wheels and Tyres

Chassis Features

- Three user selectable adaptive damping settings;
 - GT.
 - Sport.
 - Sport+.
- Anti-Lock Braking System (ABS).
- Hydraulic Brake Assist (HBA).
- Electronic Brake Force Distribution (EBD).
- Three-stage Electronic stability Program (ESP).
- Dynamic Torque Vectoring (DTV).

Wheel and Tyre Information

	Front	Rear
Wheel Size	9J x 20	11J x 20
Tyre Size	255/40 R20 (Y)	295/35 R20 (Y)
Tyre Pressure	2.5 Bar 36 Psi	2.6 Bar 38 Psi

Tyre Loading

Tyres installed to this vehicle shall have a maximum load rating not less than 825 kg (1819 lbs) front and 925 kg (2039 lbs) rear, or a load index of 101 (front) and 105 (rear).

Wheel Bolt Torque

For wheel bolt torque (Refer to 'Wheel Bolt Torque', page 12.51).

Wheel Alignment

For the most up to date wheel alignment values, contact your Aston Martin dealer

Tyres

Tyres of the correct type, manufacturer and dimensions, with correct cold inflation pressures are an integral part of every vehicle's design. Regular maintenance of tyres contributes not only to safety, but to the designed function of the vehicle.

Road holding, steering and braking are especially vulnerable to incorrectly pressurised, badly installed or worn tyres.

Tyres of the correct size and type, but made by different manufacturers can have widely varying characteristics.

Tyre Pressures

Make sure that correct tyre pressures are carefully maintained. Road holding, steering, braking and tyre wear are especially vulnerable to incorrect tyre pressures.

Check tyre pressures regularly and before starting any journey, and adjust accordingly.

Tyre pressures increase slightly when the tyres are hot. For an accurate reading, tyre pressures should be checked when the tyres are cold. After adjusting the tyre pressures, make sure that the valve caps are securely replaced to provide an additional air seal and to prevent the ingress of dirt.

Tyre Information

Damage

 *Because of the high performance potential of this vehicle, Aston Martin strongly recommend replacement of any damaged or worn tyre.*

Tyres should be examined at regular intervals for wear and damage. Inspect the tyre treads and sidewalls for damage, i.e. bulges in the tread or the sidewalls, cracks in the tread groove and separation in the tread or the sidewalls. If damage is observed or suspected have the tyre inspected by a tyre professional.

Stones or other objects which have become lodged in the tyre treads should be carefully removed.

Flat Spots

It is a characteristic of high performance tyres that temporary 'flat spots' may develop if the vehicle is left standing in high or low ambient temperatures for any length of time.

These 'flat spots' will manifest themselves as minor vibrations when the vehicle is first driven from cold. As the tyres warm up to operating temperature, normal tyre shape should be restored and the vibrations cease. If vibrations persist, consult your Aston Martin Dealer.

Age

 *Local regulations on tyre life may apply.*

Tyres degrade over time, even when they are not being used. It is recommended that tyres generally be replaced after six years of normal service. Heat caused by hot climates or frequent high loading conditions can accelerate the aging process.

New Tyres

Each wheel and tyre unit must be balanced dynamically and measured for Radial Force Variation (RFV) to make sure of efficient steering, optimum tyre wear and maximum ride comfort. Because of the potentially high speeds, it is essential that wheel balancing is carried out when new tyres are installed. Contact your Aston Martin Dealer for more information.

Running-In New Tyres

When new tyres have been installed, speed should be limited, particularly during the first 80 km or so of driving. Fast cornering, hard braking, and harsh acceleration should also be avoided during this period.

Tread Wear Marks

Tread wear marks (A) are incorporated into the construction of all tyres. These marks are integral moulded ribs spaced at regular intervals around the circumference of the tyre and extend across the full width of the tread, in all primary grooves.

When a tyre has worn causing one or more of the marks to be flush with the outer face of the tread the tyre has reached its wear limit. It then becomes illegal in certain countries and must be replaced.



Summer Tyres

The recommended tyres for this vehicle are asymmetrical and must be installed to the wheel with the tyre mark 'OUTSIDE' on the outside of the wheel rim.

The tyres are also of different sizes on the front and rear axles, therefore complete wheels cannot be swapped between axles.

Winter Tyres

The tyres installed as original equipment are designed with a rubber compound, tread pattern and width specially suited for high speeds in normal road conditions, but they are less suitable during extremes of low temperatures, snow and ice. The use of winter tyres will considerably improve handling during these conditions.

Only use Aston Martin approved winter tyres - contact your Aston Martin dealer for more information.

⚠ Warning: The maximum speed limit of the vehicle should be reduced when winter tyres are installed. Winter tyre speed limits and information should be provided upon installation. Please consult your Aston Martin Dealer for more information.

Winter tyres must be installed to the correct winter wheels.

Winter tyres must be used in vehicle sets, that is, installed on all four wheels. Do not exceed the tyre speed rating when using winter tyres.

Electrical Systems

Snow Traction Devices

⚠ Warning: The maximum speed when using snow traction devices is 48 km/h. Remove the snow traction devices immediately when the roads are clear of snow.

These are for temporary use when driving in heavy snow conditions. Snow traction devices should only be installed to the rear (driven) wheels. For more information regarding the correct snow traction device to fit to your vehicle, contact your Aston Martin Dealer.

Fuses

The electrical systems are protected by fuses. If any lamps, accessories, or controls do not function, inspect the applicable fuse.

If a fuse has blown, the inside element will be melted. If the same fuse blows again, avoid using that system and consult your Aston Martin Dealer as soon as possible.

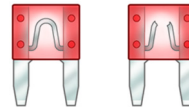

Front Fuses

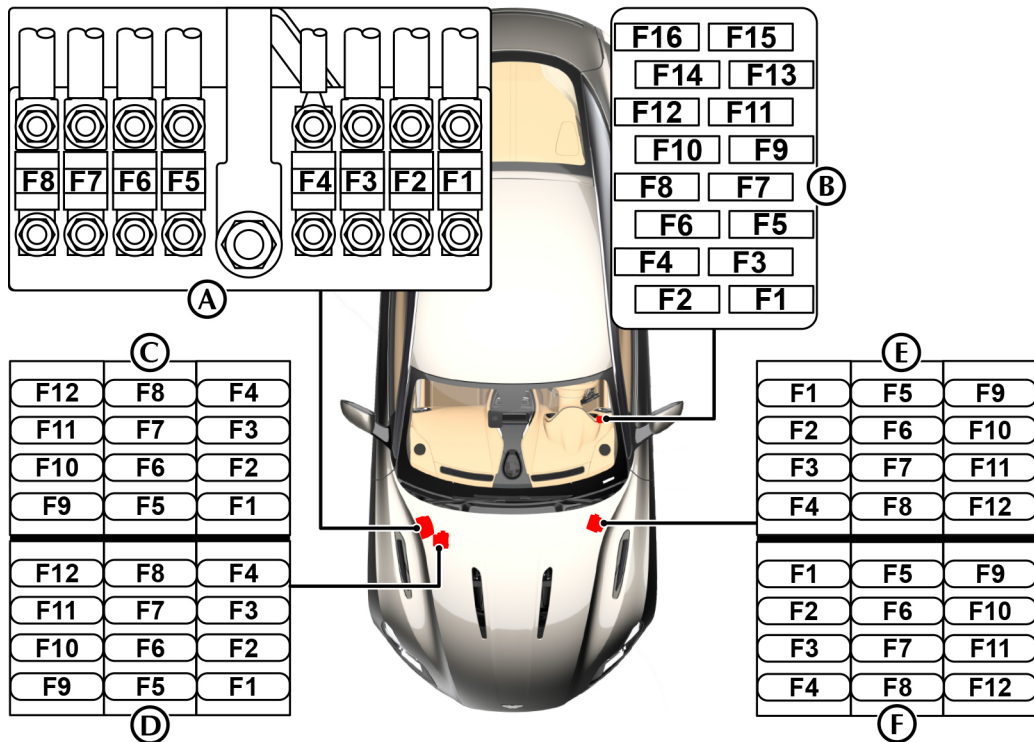

Engine Primary Fuse Box (A)

V12 Engine

F1	150A	Electronic Power Assisted Steering (EPAS)
F2	100A	Cooling Fan
F3	150A	Right Side Engine Fuse Box
F4	50A	ABS Module
F5	100A	Left Side Powerhold Fuse Box
F6	100A	Right Side Powerhold Fuse Box
F7	100A	Left side Engine Fuse Box
F8	100A	Left side Engine Fuse Box

V8 Engine

F1	150A	Electronic Power Assisted Steering (EPAS)
F2	100A	Cooling Fan
F3	150A	Right Side Engine Fuse Box
F4	50A	ABS Module
F5	100A	Right Side Engine Fuse Box
F6	100A	Right Side Powerhold Fuse Box
F7	100A	Right Side Powerhold Fuse Box
F8	100A	Left Side Powerhold Fuse Box

IP Fuse Box (B)

F1	10A	Control Dial Touch Pad Instrument Cluster Fan
F2	15A	HVAC Module
F3	5A	Instrument Cluster
F4	15A	OBD Socket
F5	20A	Infotainment Unit
F6	15A	Steering Column Control Module (SCCM)
F7	20A	Drive Unit
F8	5A	-
F9	7.5A	SCCM
F10	15A	Common Powertrain Control (CPC) module
F11	5A	Centre Stack Panel
F12	5A	CPC module
F13	7.5A	Central Display
F14	10A	OBD Socket
F15	20A	Electronic Steering Lock
F16	5A	Feedback signal to Body Controller - Front (BCF)

Right Powerhold Fuse Box (C)

V12 Engine

F1	-	-
F2	-	-
F3	-	-
F4	-	-
F5	10A	HEGO Sensor Bank A Catalyst Monitor Bank A
F6	20A	Coolant water pump A Central Fan Module
F7	5A	Oil Level Sensor Mass Air Flow (MAF) Sensor A Cannister Purge A Starter Relay Secondary Air Relay A
F8	10A	-
F9	20A	Fuel Injectors Bank A
F10	15A	Ignitions Coils Bank A
F11	10A	Variable Cam Timing (VCT) unit A Compressor Valve A Secondary Air Injector A Variable Oil Pump Coolant Pump Run On
F12	15A	Differential Cooling Pump

V8 Engine

F1	-	-
F2	-	-
F3	-	-
F4	-	-
F5	-	-
F6	20A	Coolant water pump B
F7	20A	Cooling Fan
F8	20A	Coolant water pump A
F9	25A	Engine Supply
F10	25A	Engine Supply
F11	10A	Purge Valve A Purge Valve B
F12	15A	Differential Cooling Pump

Right Side Engine Fuse Box (D)

V12 Engine

F1	5A	ECM Keep Awake
F2	15A	Right Side Powerhold Supply
F3	5A	Right Side Powerhold Control
F4	5A	ABS Module
F5	30A	Right Side Wiper Motor
F6	40A	Secondary Air Pump A ABS Module
F7	40A	ABS Module
F8	-	-
F9	30A	Starter Motor
F10	15A	Horn
F11	5A	Bonnet Latches
F12	-	-

V8 Engine

F1	5A	ECM Keep Awake
F2	15A	Right Side Powerhold Supply
F3	5A	ABS Module
F4	30A	Starter Motor
F5	30A	Left Side Wiper Motor
F6	30A	Right Side Wiper Motor
F7	5A	Relay Tracker
F8	40A	ABS Module
F9	-	-
F10	15A	Horn
F11	5A	Bonnet Latches
F12	-	-

Left Side Engine Fuse Box (E)

V12 Engine

F1	5A	ECM Keep Awake
F2	15A	Left Side Powerhold Supply
F3	5A	Left Side Powerhold Control
F4	5A	Tracker
F5	30A	Left Side Wiper Motor
F6	40A	Secondary Air Pump B
F7	-	-
F8	-	-
F9	40A	Vacuum Pump
F10	-	-
F11	-	-
F12	5A	Vacuum Pump Monitor

V8 Engine

Not Applicable

Left Powerhold Fuse Box (F)

V12 Engine

F1	5A	ABS Module
F2	5A	Engine Control Module Wake up
F3	5A	Tyre Pressure Monitoring System (TPMS)
F4	15A	Daytime Running Lights
F5	10A	HEGO Sensor Bank B Catalyst Monitor Bank B
F6	20A	Coolant water pump Bank B
F7	10A	Engine Coolant Level Sensor MAF Bank B Cannister Purge B Secondary Air Relay B
F8	15A	Exhaust Flaps
F9	20A	Fuel Injectors Bank B
F10	15A	Ignitions Coils Bank B
F11	10A	VCT Bank B Compressor Valve B Secondary Air Injector B
F12	10A	Sound regulator

V8 Engine

F1	5A	ABS Module
F2	5A	Engine Control Module Wake up
F3	5A	Tyre Pressure Monitoring System (TPMS)
F4	15A	Daytime Running Lights
F5	10A	Engine Supply
F6	20A	Engine Supply
F7	-	-
F8	15A	Exhaust Flap
F9	-	-
F10	-	-
F11	-	-
F12	-	-

Rear Fuses

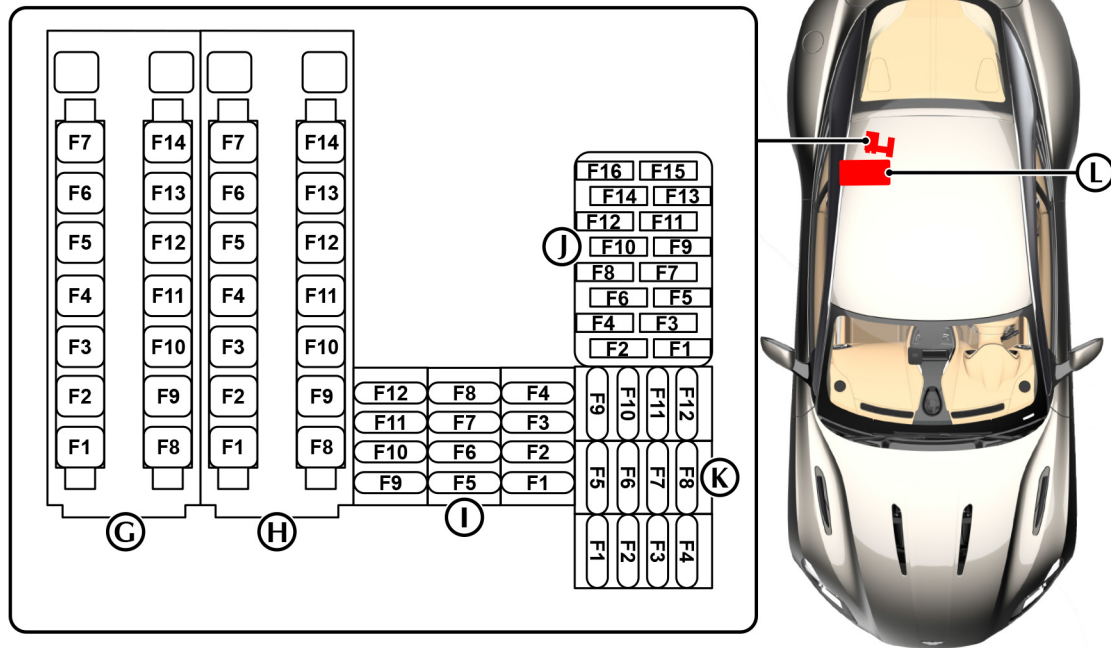

Rear Primary Fuse Box (G)

F1	50A	IP Fuse box (B) Supply
F2	50A	IP Fuse box (B) Supply
F3	50A	Fuse Box (K) Supply
F4	50A	Fuse Box (K) Supply
F5	60A	Fuse Box (K) Supply
F6	30A	Right Side Door Module
F7	30A	Left Side Door Module
F8	40A	Body Controller Rear (BCR)
F9	40A	BCR
F10	40A	Body Controller Front (BCF)
F11	40A	BCF
F12	50A	Fuse Box (I) Supply
F13	30A	IP Fuse box (B) Supply
F14	20A	Fuse Box (I) Supply

Rear Primary Fuse Box (H)

F1	50A	IP Fuse box (B) Supply
F2	40A	Fuse Box (J) Supply
F3	50A	Fuse Box (J) Supply
F4	50A	Fuse Box (J) Supply
F5	50A	Fuse Box (J) Supply
F6	-	-
F7	30A	Heated Rear Window
F8	30A	Convertible Roof (Volante only)
F9	40A	Convertible Roof (Volante only)
F10	30A	Right Side Rear Quarter Window (Volante Only)
F11	30A	Left Side Rear Quarter Window (Volante Only)
F12	20A	Forward Harness Supply
F13	40A	Amplifier
F14	60A	HVAC Blower

Fuse Box (I)

F1	7.5A	Occupant Restraint Controller (ORC)
F2	5A	-
F3	10A	Seat Comfort Functions
F4	5A	Tracker
F5	-	-
F6	10A	Blind Spot Monitoring Radar
F7	5A	Fuel Supply Control Module (FSCM)
F8	5A	-
F9	10A	Transmission Control Module (TCM)
F10	-	-
F11	5A	Feedback signal to Body Controller - Rear (BCR)
F12	20A	Forward Harness Supply

Fuse Box (J)

F1	10A	Left Side Seat Module
F2	15A	Camera Module
F3	15A	TCM
F4	15A	Left Side Seat Lumbar Adjust
F5	-	-
F6	5A	Multimedia Box
F7	5A	Tuner Box
F8	15A	Right Side Seat Lumbar Adjust
F9	5A	Body Controller
F10	25A	Adaptive Damping Module
F11	10A	Right Side Seat Module
F12	5A	Rain/Light Sensor
F13	5A	Park Distance Control
F14	5A	Amplifier (non B&O)
F15	7.5A	-
F16	5A	Brake Pedal Sensor

Fuse Box (K)

F1	10A	Microwave Sensors
F2	7.5A	ORC
F3	5A	Ignition/accessory Relay Control
F4	25A	Left Side Seat Module
F5	5A	Keyless Go Module
F6	20A	Charger Port
F7	25A	Right Side Seat Module
F8	5A	Deck Lid Latch
F9	25A	Fuel Supply Control Module (FSCM)
F10	25A	12V Accessory Socket
F11	15A	Centre Stack Panel
F12	20A	-

Battery and Battery Disconnect Switch (I)

Vehicle Battery: Banner 92AH

The vehicle battery is maintenance free and should only require checking by your Aston Martin Dealer during regular vehicle services. To access the vehicle battery remove the trim panel, located in the right rear environment.

Battery Information

Battery Warnings

⚠ Warning: Do not allow flames, sparks or lighted substances to come near the battery. Batteries normally produce explosive gases when charged or when jump started. When working near the battery, always make sure that neither you nor the battery is electrostatically charged. Always have sufficient ventilation.

⚠ Warning: Never place metal objects on the battery or allow the positive terminal of the battery to contact parts of the vehicle body. This can create a spark or a short circuit which can ignite gases created when the battery is charged.

⚠ Warning: When lifting a plastic cased battery, excessive pressure on the end walls could cause acid to flow through the vent caps, resulting in personal injury, damage to the vehicle or battery. Lift the battery with a battery carrier or with your hands on opposite corners.

⚠ Warning: Keep batteries out of reach of children.

⚠ Warning: Batteries contain sulphuric acid. Avoid contact with skin, eyes or clothing. Shield your eyes when working near the battery to protect against possible splashing of acid solution. In case of acid contact with skin or eyes, flush immediately with water for a minimum of 15 minutes and get prompt medical attention. If acid is swallowed, get medical help immediately.

⚠ Caution: The engine must never be run with the vehicle battery disconnected. This can cause damage to vehicle electrical modules.

⚠ Caution: Apart from vehicle recovery, this vehicle must not be driven if the vehicle battery is incapable of starting the engine. In this case the vehicle battery must be replaced. Contact your Aston Martin Dealer.

⚠ Warning: Battery posts, terminals and related accessories contain lead and lead compounds. Wash hands after handling.



Battery Level Protection

⚠ Caution: If the battery is not capable of starting the engine, replace the battery as soon as possible.

Using vehicle electrical systems such as the infotainment system, with the ignition ON, but the engine OFF, will drain the battery charge.

To prevent battery voltage falling below the level required to start the vehicle, the vehicle's battery monitoring system will shut down non-essential electrical systems before this happens.

After approximately 2 to 10 minutes (dependent on the rate of battery charge drain) a message is shown in the infotainment display.

If a low battery warning message shows, start the engine and let it idle so the battery can recharge¹, or connect a suitable battery charger or conditioner.

¹ If driving the vehicle to recharge the battery, a journey distance of approximately 30 miles or 48 km will be sufficient to recharge the battery.

Vehicle Battery Disposal

The incorrect disposal of a vehicle battery can be extremely hazardous to health and the environment. Most batteries contain materials that, when disposed of incorrectly, may leak into the environment. This can contribute to soil and water pollution and endanger wildlife.

Do not dispose of a battery in fire or water.

Follow your local authorised standards for disposal. Call your local authorised recycling centre to find out more about recycling automotive batteries. Do not dispose of your vehicle battery in the household waste.



Battery Conditioner

(Optional)

⚠ Caution: Do not attempt to start the vehicle with a battery conditioner connected to the mains supply.

The Aston Martin battery conditioner is suitable for use on all types of 12 volt AGM and lead acid batteries.

If this vehicle is not going to be used for a period of time, and mains power is available, use a battery conditioner to maintain the battery charge level. When connected the battery conditioner will maintain a small trickle charge to keep the battery in a fully charged state. A battery conditioner is designed for conditioning of partially or fully charged batteries. It will not effectively charge a discharged battery.

The battery conditioner uses a magnetic disc to attach to the charger socket (A). To connect the battery conditioner, open the deck lid and attach the charger plug onto the charger socket. The deck lid can then be closed and locked with the charger connected.

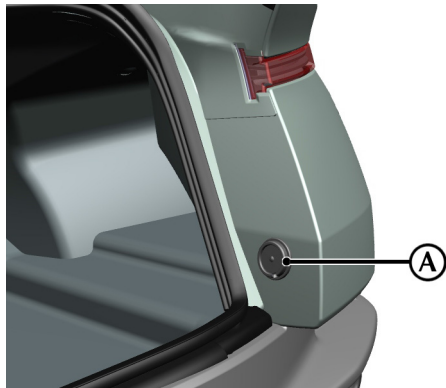

 For further safety information and operating instructions, refer to the instructions supplied with the battery conditioner.

Lamps

External Lamps

All external lamps use LEDs and are contained in a sealed lamp units.

The lamp units are not repairable. If a lamp or lamp unit fails contact your Aston Martin Dealer.

Internal Lamps

All internal lamps are LEDs and are not repairable.

If an LED lamp fails contact your Aston Martin Dealer.

Driving Abroad

The headlamps in this vehicle do not require adjustment when driving in countries where vehicles are driven on the opposite side of the road¹. The headlamps meet ECE requirement to operate without conversion.

1. Opposite to the country in which your vehicle is registered.

Vehicle Care

Washing

⚠ Warning: *Washing and polishing agents containing silicone should not be applied to glass. This will reduce the efficiency of the windscreen wipers, causing smears which will reduce visibility, particularly during darkness and in the rain.*

⚠ Caution: *Commercially operated automatic vehicle washes, jet washes and power operated mops are not recommended. The detergents used can contain certain chemicals which may, over time, be detrimental to some exterior parts of the vehicle. Prolonged usage of automatic vehicle washes and power operated mops will also cause fine scratches in the paint surface.*

Aston Martin are able to supply a range of products to clean and protect your vehicle. Contact you Aston Martin Dealer for further information.

During the winter months, it is advisable to wash the vehicle more frequently, paying particular attention to the underside to combat the detrimental effects of any salt and sand contamination picked up from treated roads.

To delay the onset of corrosion developing on the brake components, Aston Martin recommend that after washing this vehicle, the vehicle should be driven a short distance to make sure that all water and cleaning products have dried off.

For best results:

- Do not wash the vehicle in strong sunlight. Let the vehicle cool before washing.
- Do not use household soaps or detergents.
- Do not direct water hoses at full force around the door and boot lid seals.
- Do not use a brush on the car body as this will leave little scratches.

Suggested washing method:

1. Fill two buckets with water. Add a mild neutral detergent, as directed by the detergent manufacturer to one of the buckets.
2. Use a hose to remove all dust and mud residue from the vehicle. Don't use a strong jet, as this can rub grit over the paint and scratch it.
3. Soak a large clean wash mitt or a soft clean sponge in the soapy water, and begin applying it to the vehicle. Wash the vehicle section by section, starting at the top. Circle around the car several times, washing lower areas with each round. Rinse the dirt out of the wash mitt or soft sponge in the bucket with plain water frequently.
4. After one section is washed, rinse it with the hose before moving on, don't let the soap dry on the paint as this can stain it. Always keep the vehicle wet, this will prevent droplets from drying on the paint and leaving water-spots.
5. Dry the car with a chamois leather before it air-dries.

Paint Work

Modern water based paints are much safer and more environmentally friendly than solvent based paints. Water based paints are however more susceptible to contamination and marking by corrosive substances. The following list is not exhaustive but does show the most common contaminants which may adversely affect your paint work:

- Bird droppings,
- Antifreeze,
- Tree sap,
- Oils and greases,
- Insect remains.

Wash such substances from the vehicle using clean warm water with vehicle shampoo at the earliest opportunity, especially in sunny weather which can accelerate contamination.

 *Other groups of contaminants may be added to this list as experience of water based paints and finishes increases.*

Satin Paint

(Optional)

! The Aston Martin new car warranty covers defects in materials or workmanship of the paint work. The warranty does NOT cover repairs to your satin or matt paint work caused by negligence, lack of or improper maintenance such as waxing or polishing the finish, environmental influences, or improper repairs or damage that causes the satin finish to become glossy.

In comparison to conventional paints with a gloss or metallic surface, satin paint work must be cared for slightly differently. In order to avoid damage to the satin paint work, make sure that the cleaning and care points below are followed:

1. Only use cleaning products recommended by Aston Martin. Abrasive cleaning products will change the satin appearance of the paint and must not be used.
2. Do not polish or wax the paintwork. This can lead to glossing of the paintwork.
3. Do not wash the car in an automatic car wash. This will avoid particles such as sand and dust, from damaging the painted surface.
4. Only use a soft sponge to clean the vehicle. Do not use abrasive cleaning tools.
5. Remove insect remains, bird droppings, resins, tar spots, fuels and oil immediately. Avoid strong rubbing while cleaning the vehicle.
6. Any stickers applied to the paint work will leave a mark when removed.
7. Repairs to the paint work must be completed by an Aston Martin category A or B body shop.

Front Grille

Wash and clean the vehicle's front grille in the same way as the paint work, but make sure that the front grille is dried off completely leaving no water droplets on the grille (wipe the front grille last using a chamois leather): Chrome polish or other abrasive cleaners must not be used.

Road Wheels

To avoid possible damage to the alloy road wheels, wheel nuts and wheel centre trims, from a build up of brake dust wash and clean the alloy road wheels frequently, using a mild soapy water solution only. Do not use chemical alloy road wheel cleaners, as they can often have a high acid or alkaline content and could cause discolouration. Always clean one wheel at a time and do not allow the cleaning solution to dry on the wheel. Fully flush off with clean water.

Headlamp Lenses

Only use a mild soapy water solution when washing the headlamp lenses. Do not use cleaning materials which contain solvents.

Cleaning materials which contain solvents, i.e. tar remover, petrol, waxes or polishes, may damage the headlamp lens.

Under Bonnet Cleaning

Under bonnet cleaning using high pressure hoses or steam cleaners should not be carried out. The electronic control module connections and fuse boxes can be damaged by indiscriminate use of high pressure cleaning equipment.

Polishing

Approximately twice a year, a good quality polish should be applied to the body work and then buffed, using a soft lint free cloth.

The alloy wheel rims should be treated with a cleaner which is specifically manufactured for this purpose.

Bodywork Maintenance

Check the drain holes in the bottom face of each door periodically and clear if necessary.

Upholstery, Trim, Carpets and Seats

⚠ Warning: *Fumes from cleaning solvents may be dangerous in confined spaces. Make sure that the vehicle is well ventilated and follow the manufacturer's printed instructions when using these products.*

⚠ Caution: *Certain types of clothing, such as denim and vegetable tanned leather, are prone to 'dye transfer'. This can cause discolouration in the leather. Make sure that the affected areas are cleaned and re-protected as soon as possible.*

The seats and soft trimmed components of this vehicle are covered in natural leather hide. In general, this natural leather upholstery requires little attention. The seats should be brushed with a soft brush from time to time and may be cleaned occasionally with a cloth damped in soap and water.

Do not use detergents, quick cleansers or furniture polishes. These products may initially give an impressive result, but their use will lead to rapid deterioration of the leather and will invalidate the warranty.

Several times a year, a leather conditioner or preservative should be used. Appropriate care materials are obtainable from your Aston Martin Dealer.

The brushed and anodised aluminium trim should be cleaned using a dry clean lint free cloth.

Alcantara®¹ roof linings and other soft trimmed areas may be brushed with a soft brush. Stains from water based substances such as coffee, tea or soft drinks should be cleaned as soon as possible with mild soap and water.

Consult your Aston Martin Dealer for instructions on the removal of more difficult stains such as oil, grease or ballpoint ink.

Carpets should be cleaned regularly with a vacuum cleaner. Any stains or grease marks should be removed with a good quality solvent suitable for use on carpets.

¹ Alcantara is the registered trademark of Alcantara SPA, Italy and used with permission

Care and Maintenance of Seat Belts

⚠ Caution: Do not allow seat belts to be retracted until they are completely dry.

To make sure that the restraint webbings are in correct working order, regularly check the seat belts. Look for fraying, cuts, burns and similar problems. Make sure that the latches and buckles operate correctly. If a seat belt is not in good condition or is not working correctly, consult your Aston Martin Dealer.

Any seat belt that has been worn during a serious collision should be replaced by an Aston Martin Dealer.

To clean the seat belts, use mild soap and water; do not use bleach, solvents or dyes, as they can weaken the material. Allow the seat belts to dry thoroughly before use.

Convertible Roof Cleaning

⚠ Caution: Do not leave the roof in the lowered (folded) position for extended periods of vehicle storage. Permanent damage to the convertible roof fabric may occur including soiling and fading along folds.

⚠ Caution: Do not use automatic vehicle washes. Brushes, detergents and pressurised water jets may damage the roof fabric. Do not use power washers. Jets of water may damage the weather seals and the roof fabric. Do not use spot cleaners, chemical diluents or any organic cleaners. If in doubt, contact your Aston Martin Dealer.

To maintain the appearance and condition of the roof fabric the cleaning recommendations given below should be followed. This is of particular importance in the case of light coloured roof fabrics.

Always remove bird droppings as soon as possible. The organic acids in bird lime can adversely affect the roof fabric.

Carefully vacuum clean the roof fabric to remove any loose particles. Gently, and evenly, wash the roof fabric using a mild soap solution and a soft brush.

 A hard brush will damage the fabric fibres.

Rinse the roof fabric thoroughly with clean water to remove any traces of soap. Allow the roof fabric to completely dry before operating the roof.

Powertrain Specifications

5.2L V12 Engine

All alloy 48 valve twin turbocharged V12 engine featuring:

- Independent quad-variable camshaft timing.
- 3 driver selectable powertrain modes.
- Cylinder deactivation.
- Engine stop/start.
- Twin water-to-air charge air coolers.

Engine Capacity

5204 cc (317 CID).

89 mm (3.5 inch) Bore.

69.7 mm (2.75 inch) Stroke.

Compression Ratio

9.2:1.

Firing Order

1 - 7 - 5 - 11 - 3 - 9 - 6 - 12 - 2 - 8 - 4 - 10.

Fuel delivery

Multi-point sequential fuel injection.

Idle Speed

650 rpm.

Ignition

'Coil on Plug' Ignition System.

Lubrication

Wet sump pressurised system.

Emission Controls

Four oxygen sensors (two per bank) with two catalytic converters (one per bank).

Evaporative loss purge system.

4.0L V8 Engine

All alloy 32 valve twin turbocharged V8 engine featuring:

- Independent quad-variable camshaft timing.
- 3 driver selectable powertrain modes.
- Engine stop/start.
- Twin water-to-air charge air coolers.

Engine Capacity

3982 cc (242 CID).

83 mm (3.26 inch) Bore.

92 mm (3.62 inch) Stroke.

Compression Ratio

10.5:1.

Firing Order

1 - 5 - 4 - 2 - 6 - 3 - 7 - 8.

Fuel delivery

Multi-point sequential fuel injection.

Idle Speed

800 rpm.

Ignition

'Coil on Plug' Ignition System.

Lubrication

Wet sump pressurised system

Emission Controls

Four oxygen sensors (two per bank) with four catalytic converters (two per bank).

Evaporative loss purge system.

Transmission

Touchtronic IV Automatic Transmission

Rear mounted ZF 8HP70 eight-speed automatic gearbox with 'Shift by Wire' gear shift and Stop/Start ignition support.

Front mounted transmission radiator with transmission mounted heat exchanger and pump.

Drive line

Cast aluminium torque tube with carbon fibre drive shaft.

Final Drive

Limited-slip differential with integrated coolant jacket.

Gear Ratios

1st	4.714
2nd	3.143
3rd	2.106
4th	1.667
5th	1.285
6th	1.000
7th	0.839
8th	0.667
Reverse	3.317
Final	2.703

Performance

	V12 Coupe	V8 Coupe	V8 Volante
Maximum Power	470 kW 630 Bhp at 6500 rpm	375 kW 503 Bhp at 6000 rpm	375 kW 503 Bhp at 6000 rpm
Maximum Engine Speed	7000 rpm	7000 rpm	7000 rpm
Maximum Torque	700 Nm 516 Lb.ft at 1600 rpm	675 Nm 498 Lb.ft at 2000 rpm	675 Nm 498 Lb.ft at 2000 rpm
Maximum Speed (Where Permitted)	208 mph 335 km/h	187 mph 300 km/h	187 mph 300 km/h
0-62 mph (100 km/h)	3.7 Seconds	4.0 Seconds	4.1 Seconds

Dimensions

Interior Dimensions		Vehicle Weights	V12 Coupe	V8 Coupe	V8 Volante
Front		Unladen Mass	1870 kg 4125 lbs	1760 kg 3880 lbs	1870 kg 4125 lbs
Effective Headroom	980 mm / 38.5 Inches	Gross Vehicle Weight (GVW)	2290 kg 5050 lbs	2180 kg 4820 lbs	2290 kg 5050 lbs
Effective Leg-room	1145 mm / 45 Inches	Luggage Compartment Volume		280 Litres / 10 Cu ft	
Effective Shoulder-room	1380 mm / 54 Inches	Luggage Compartment Load ₁		40 kg / 90 Lbs	
Rear		Towing Capacity ₂		Not Applicable	
Effective Headroom	635 mm / 25 Inches				
Couple Distance ₁	635 mm / 25 Inches				
Effective Shoulder-room	1235 mm / 48.5 Inches				

₁. The couple distance is the distance between the hip point for the rear occupant and the hip point for the front seat occupant.

₁. Maximum load, Evenly Distributed

₂. This vehicle is not engineered to tow any form of caravan, boat or trailer. No towing devices are approved to install to this vehicle, other than a front towing eye to aid recovery of loading of this vehicle onto a transporter.

External Dimensions

Coupe

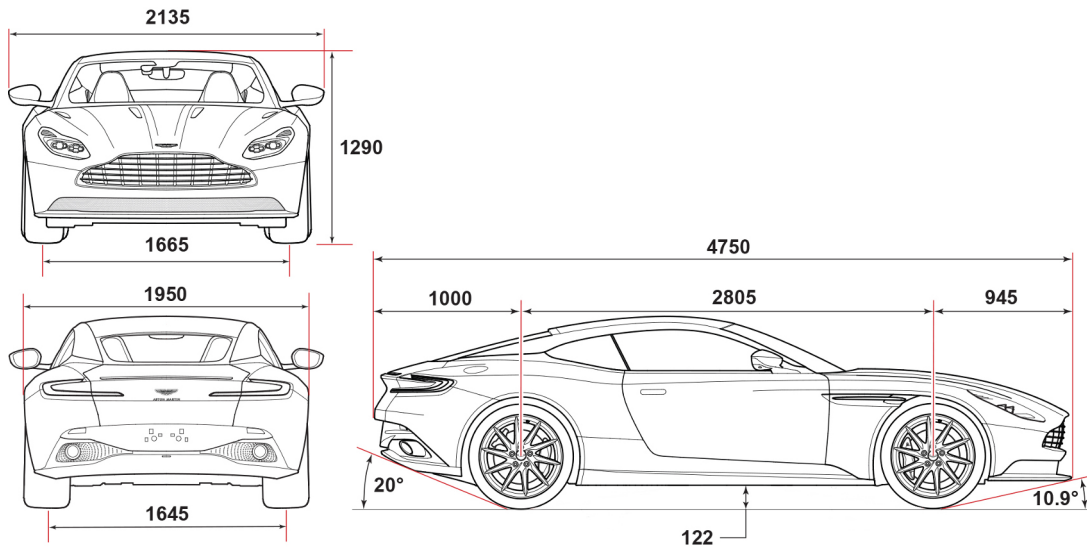

All dimensions shown in mm.

Volante

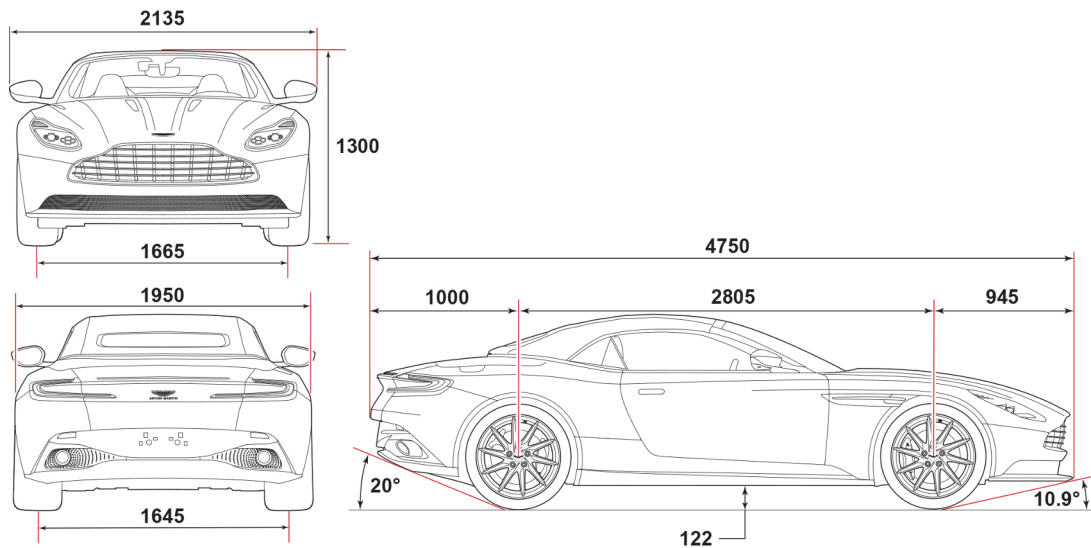

All dimensions shown in mm.

Emergency and Breakdown

Vehicle Recovery

⚠ **Caution:** *When the vehicle is moved by transporter make sure that the vehicle is not strapped down by the suspension control arms.*

⚠ **Caution:** *Power braking and power steering are not available with the engine off. Substantially higher brake pedal pressures and steering effort are required.*

⚠ **Caution:** *If there is a transmission fault, this vehicle must be transported.*

If the park brake was applied and the vehicle has lost power, the park brake will not release. Call Aston Martin Assistance or your local Aston Martin Dealer.

Your vehicle should always be recovered on a vehicle transporter¹ and should only be towed for **short distances**, for example, if it is causing an obstruction or if it requires winching onto a transporter.

If moving the vehicle in such a situation:

1. Remove the tow eye from its storage location in the vehicle tool kit (located in the boot storage area). Insert the tow eye carefully through the grill and install to the exposed female threads (A) until fully engaged against the vehicle body.

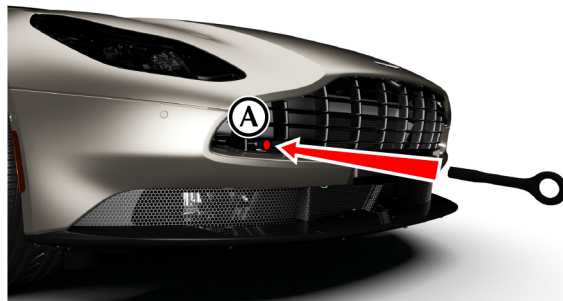

📖 *The tow eye has a left hand thread.*

📖 *Protect vehicle paint work when installing the tow eye.*

2. When being towed use the footbrake very gently when required, to prevent excessive slack in the tow rope.

¹. The recommended method for a recovering vehicle is to have it transported in a purpose built, covered, vehicle transporter.

Automatic Transmission Fault Conditions

Limp Home Conditions

If a fault is detected the vehicle will go into one of three limp home modes:

Electrical

GEARBOX FAULT REDUCED FUNCTION will show in the instrument cluster. Touchtronic and sport modes will be disabled and gearshifts will not be possible. The transmission will select either 3rd or 6th gear depending on the vehicle speed at the time of the fault.

Contact your Aston Martin Dealer



In certain circumstances forward drive will be restricted to a fixed gear.

Mechanical

LIMPHOME NO GEAR CHANGE will show in the instrument cluster and a warning sound will be heard. If travelling forwards in auto drive or touchtronic mode the vehicle will go into 6th gear.

If entering mechanical limp home mode in any position other than auto drive or touchtronic mode the park-lock will come on. Contact your Aston Martin Dealer.

Parklock

If the vehicle fails to start or has broken down, the automatic transmission will move into P (Park) to prevent unintended vehicle movement. The parklock will not release. Call Aston Martin Assistance.

Jump Start From Another Vehicle

⚠ Warning: The donor vehicle must have a 12 volt battery and a negative (-) earth terminal to make sure that the correct battery polarity is maintained.

⚠ Caution: Apart from vehicle recovery, this vehicle must not be driven if the vehicle battery is incapable of starting the engine. In this case the vehicle battery must be replaced.

⚠ Caution: If the voltage or earth of the donor vehicle is different or not known, do not attempt starting in the way described.

If this vehicle will not start due to a discharged battery, it may be started, **for vehicle recovery**, by connecting the battery from another vehicle (donor) to this vehicle (recipient).

Jump Start Procedure

⚠ **Caution:** Remove rings, metal watch bands and any other jewellery.

⚠ **Caution:** Set all electrical motors and ancillaries in both vehicles to OFF.

⚠ **Caution:** Set all lamps to OFF except those needed to protect vehicles or illuminate the work area.

📖 Recharge time will depend on the initial 'state of health' of the discharged battery.

📖 If the vehicle still will not start, contact your Aston Martin Dealer.

1. Position the donor vehicle so that the connecting cables will reach into the recipient engine bay. Apply the park brake and leave the engine running.
2. Access the jump start terminal in the recipient engine bay.
3. Remove the cover for the main power fuse bank (1)



4. Identify the positive (2) and negative (3) jump start points shown.

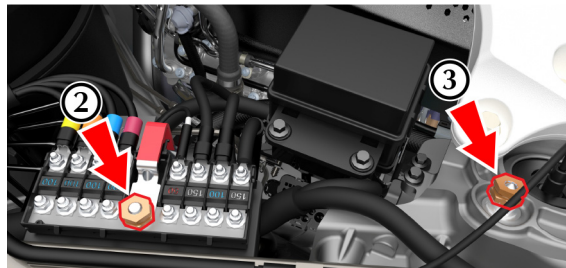

5. Connect the positive cable (4) between the positive terminal of the donor battery and the positive (+) jump point (2) on the main power feed.

6. Connect the negative cable (5) between the negative terminal of the donor battery and the suspension earth (-) nut (3).

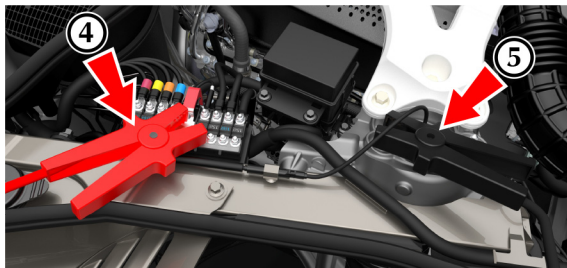

7. Start the donor vehicle engine and increase the engine speed and run at about 1500 – 2000 rpm for two minutes¹.

 *The donor vehicle must be set to OFF. If the donor vehicle is not set to OFF the recipient vehicle will not start.*

8. Set the donor vehicle to OFF.
9. Start the engine of the recipient vehicle.
10. Leave the jump start cables attached and the engines running for 2 to 3 minutes to allow the battery to charge.

¹. Charge time can depend on the battery state of the donor vehicle.

11. Remove the jump start cables, first the negative cable from both vehicles and then the positive cable from both vehicles.

Allow the recipient engine to run until the discharged battery is sufficiently charged (15 to 20 minutes) to start the engine without assistance. Set the engine to OFF and restart the engine. Take the vehicle on a long run to fully charge the battery.

Contact your Aston Martin Dealer to have the battery checked or replaced.

Vehicle Lifting

⚠ Warning: Make sure that no persons are in the vehicle before the vehicle is lifted.

⚠ Warning: Make sure that the park brake is applied and that the vehicle transmission is in P (Park).

⚠ Warning: Make sure that the vehicle is parked on firm and level ground to give a secure base for the jack.

⚠ Warning: Do not lift the vehicle by placing a jack or other lifting equipment under the suspension arms.

⚠ Warning: Do not use a jack or other lifting equipment further inboard on the vehicle than the jacking points shown.

If this vehicle is to be raised using a vehicle jack make sure that the following jacking points are used.

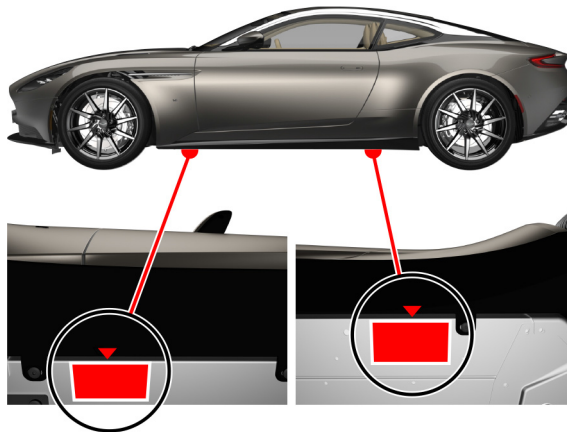

Wheel Bolt Torque

⚠ Caution: You must use an applicable plastic-sleeved socket to remove, install, and tighten the wheel bolts. This will help to prevent damage to the surface of the wheel.

All wheel bolts must be tightened in two stages:

- Tighten every second wheel bolt (in the order shown) to 70 Nm (52 lb/ft) until all five bolts are tightened.

 If a locking wheel bolt is installed, this should be installed last.

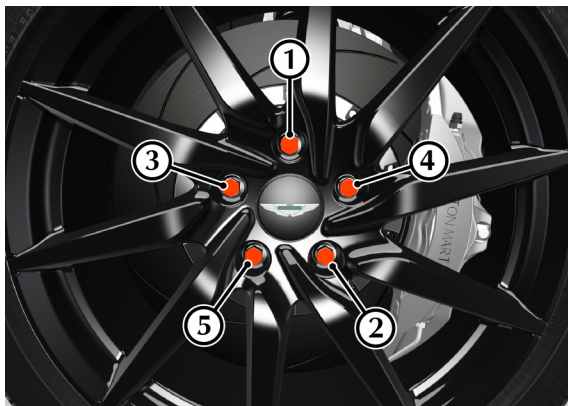

- Tighten every second wheel bolt (in the order shown) to 150 Nm (111 lb/ft) until all five bolts are tightened.

Tyre Repair Kit

⚠ Warning: Do not use the system to seal a tyre that was damaged while driving with insufficient air pressure (e.g. tyre cuts, cracks, bumps or similar damage). Do not use the system to seal tyres with side wall damage. Only punctures in the tread area of tyres may be sealed.

⚠ Warning: Do not stand directly beside the tyre while the compressor is pumping. Watch the side wall of the tyre. If there are any cracks, bumps or similar damage set the compressor to OFF. The journey should not be continued. Contact your nearest Aston Martin Dealer.

⚠ Warning: If a tyre pressure of 1.8 bar (26 Psi) cannot be reached then the tyre can not be sealed. Do not attempt to re-inflate the tyre. Contact your Aston Martin Dealer.

⚠ Warning: If the pressure in the tyre after driving for 3 km is below 1.3 bar (19 Psi) the tyre has not been effectively sealed. The journey should not be continued. Contact your nearest Aston Martin Dealer.

⚠ Warning: After a longer period of rest, the tyre pressure should be rechecked.

⚠ Caution: *The tyre sealant kit only provides temporary mobility. Always refer to local laws and regulations on the use and repair of tyres that have been treated with any form of temporary mobility aid. Consult a tyre specialist for advice.*

 *Inform the tyre specialist that the tyre contains sealant.*

 *Remains of liquid sealant must be handed over to your dealer or disposed of in compliance with local waste disposal regulations. Dispose of empty sealant bottles together with normal household waste.*

Operation

Remove the tyre sealant kit from its location in the boot. Follow the instructions detailed on the lid.

Read the following instructions and warnings carefully before using the tyre sealant kit. Compliance with these instructions is vital to make sure of vehicle and user safety. Non-compliance with these instructions means risking severe tyre damage and hazardous vehicle behaviour which can lead to a road accident involving damage to property or injury to persons.

- Make sure that the vehicle is parked far enough from traffic so that there is no danger from passing vehicles and so that you do not disrupt the traffic.
Warn other vehicles using the warning triangle.
- A maximum speed of 80 km/h (50 mph) may not be exceeded at any time after sealing the tyre with the system.

- The system provides only a **temporary emergency repair** for continuing the journey up to 200 km (125 miles) or to the nearest Aston Martin Dealer.
- If the nearest Aston Martin Dealer is over 200 km (125 miles) away, arrange for collection with Aston Martin Assistance.
- The system will effectively seal a tyre that was punctured by an object with a diameter of up to 6 mm. It is possible that a tyre, especially with greater damage, will not be sealed. Do not remove objects that punctured the tyre if they are still lodged in the tyre.
- The sealant bottle needs to be exchanged before it expires. **Do not** use the system after the expiry date on the sealant bottle or casing has been reached. Contact your nearest Aston Martin Dealer.
- Do not attempt to inflate other objects without using a system adapter and do not inflate objects with a volume greater than 50 litre (air mattresses, rubber boats, etc.). Do not let the system pump air for more than 10 minutes without stopping it and allowing it to cool down.

Both the hose and the bottle of sealant need to be replaced after using the system. Sealant deposits in a used hose may cause the system to operate incorrectly. New bottles of sealant can be purchased from your Aston Martin Dealer.

Fuel

Fuel Level Warnings

There are two stages of fuel level warning:

1. The first fuel level warnings changes the fuel symbol on the fuel gauge from white to amber. This means that the vehicle will now be using its reserve fuel level and should be refuelled at the nearest fuel station.
2. The second fuel level warning will also show a warning symbol in the right instrument cluster window and replaces the *Range* value. The vehicle is now down to half of its reserve fuel level and should be refuelled **as soon as possible**.

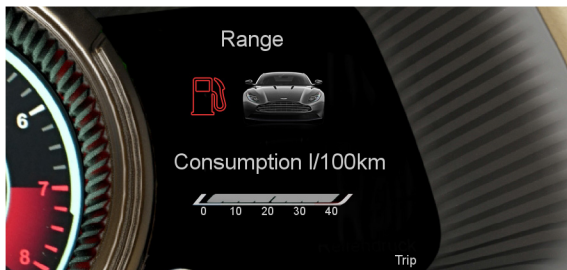

Fuel Filling

 *The fuel tank filler neck has a restricted opening which will only accept the fuel supply nozzle of unleaded fuel pumps.*

Open the fuel flap by pressing down on the rear edge of the fuel flap. If the filler flap will not open use the fuel filler flap emergency release.

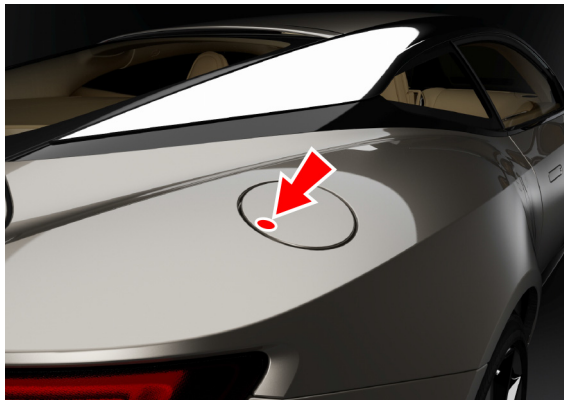

The fuel system will not let the fuel tank overflow but there will be times when the fuel nozzle will shut OFF prematurely. If this happens only try to fill the fuel tank one more time, continued attempts will result in fuel spillage. Wait 10 seconds before removing the refuelling nozzle.

Fuel Filler Bowl

To stop water gathering in the fuel filler bowl and flowing into the fuel tank, the fuel filler bowl has a pipe to let the water drain from the bowl. During fuel filling, check and make sure that any debris which may block the pipe is removed.

Fuel Cut-Off

In the event of a vehicle accident the vehicle electronics will enter crash mode. Power to the fuel pumps will stop, thereby reducing fire risk.

Fuel Filler Flap Emergency Release

To manually unlock the fuel filler flap:

1. The right side carpet for the luggage compartment (1) must be moved. Release the two fasteners (2) that attach the carpet and disconnect the luggage compartment lamp (3). Move the carpet.

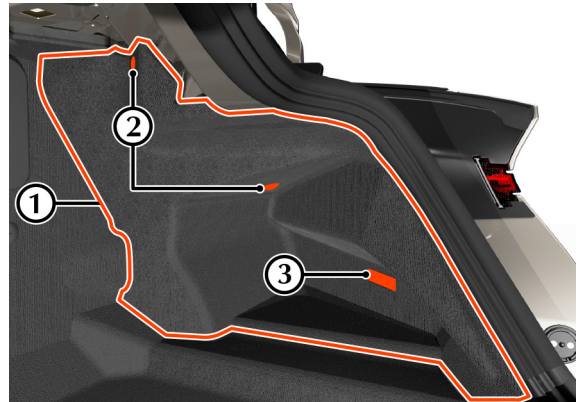

2. Reach behind the right side deck lid hinge.

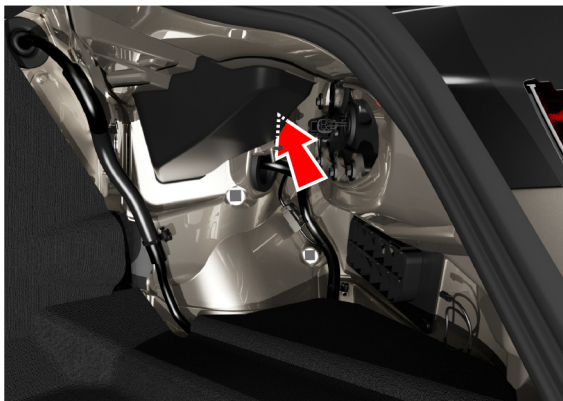

3. Pull the emergency release (ER) tab to unlock the fuel cap.

⚠ Caution: *The emergency release cable only unlocks the fuel flap. It does not open the fuel flap. Do not pull too hard on the emergency release cable. This can cause the emergency release cable to snap.*

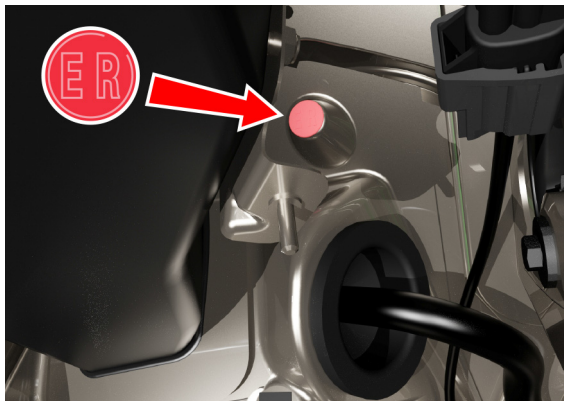

4. Open the fuel flap by pressing down on the rear edge of the fuel flap.



ASTON MARTIN

Service

Aston Martin Facilities	A.2
Vehicle Provenance.....	A.3
Servicing	A.5
Service Record	A.7
Replacement of Airbag Units	A.29
Replacement of Seat Belt Pre-tensioners.....	A.29
Field Service Actions	A.30
Service Action Recalls.....	A.31

Aston Martin Facilities

A full list of Aston Martin Dealers, Authorised Body Repair Centres and Authorised Service Centres worldwide, can be found at:

www.astonmartin.com

Every effort is made to make sure that the information given in the dealer list is accurate and up-to-date. However changes amongst holders of the Aston Martin franchise can occur. Neither Aston Martin nor any listed Importer or Dealer shall in any circumstances be held liable for any inaccuracy, or the consequences thereof.

 *Dealers and Service Centres are also available as a point of interest (POI) in the satellite navigation system.*

Aston Martin Franchise Dealers

Dealers all aim to conform to Aston Martin standards of excellence in both sales and service. However, all vehicles sold as Aston Martins are required to meet local legislation requirements. Should service be required in a country other than that in which this vehicle was originally purchased, every effort will be made to meet the owner's requirements, but the availability of certain parts may be affected by differences in vehicle and component specifications.

Aston Martin Dealers are independent traders, they are not the Company's Agents, and therefore have no authority to bind the Company or to enter into any financial or other commitments on the Company's behalf.

Only Aston Martin Dealers are authorised to carry out warranty work.

Aston Martin Authorised Service Centres

All Aston Martin Approved Service Centres have been assessed and audited to Aston Martin standards. Every effort is made to make sure that the information given in the Aston Martin Authorised Service Centres list is accurate and up-to-date. However changes can occur. Neither Aston Martin nor any Aston Martin Authorised Service Centre shall in any circumstances be held liable for any inaccuracy, or the consequences thereof.

Aston Martin Authorised Body Repairers

A full list of Aston Martin Authorised Body Repairers worldwide can be found at:

www.astonmartin.com

All Aston Martin Approved Body Repair centres have been assessed and audited to Aston Martin Body Repair Centre standards in either Category A or B.

Category A

Repairs to the bonded aluminium structure and all paint related and light structural damage.

Category B

All paint related and light structural damage.

Every effort is made to make sure that the information given in the Aston Martin Authorised Body Repairers list is accurate and up-to-date. However changes can occur. Neither Aston Martin nor any Aston Martin Authorised Body Repairer shall in any circumstances be held liable for any inaccuracy, or the consequences thereof.

Vehicle Provenance

Model:

Vehicle Identification Number:

As on the VIN plate

Body Colour:

Interior Primary Colour:

Interior Secondary Colour:

Stitch Colour:

Fascia Colour:

Jewellery Pack Colour:

First Owner

Selling Dealer

Delivery Date

Fourth Owner

Selling Dealer

Delivery Date

Second Owner

Selling Dealer

Delivery Date

Fifth Owner

Selling Dealer

Delivery Date

Third Owner

Selling Dealer

Delivery Date

Sixth Owner

Selling Dealer

Delivery Date

Servicing

Service Periods

Each item in the service schedules must be performed on time as failure to do so may void the new vehicle warranty or other warranties. It is the owner's responsibility to see that the vehicle is maintained correctly and in accordance with the manufacturer's service schedules.

Vehicle servicing is every 10,000 miles, 16,000 km or 12 months, which ever occurs first.

- 16,000 km, 10,000 miles or 12 months
- 32,000 km, 20,000 miles or 24 months
- 48,000 km, 30,000 miles or 36 months

Service Tables

The following service schedules are recommended for this vehicle. The schedules may be modified if necessary. Please consult your Aston Martin Dealer for details of any service schedule updates.

Item

Annual Service Inspections

Examine the condition, operation, adjustment and attachment of the below items:

Engine and transmission mounting system. Check for leaks.

Accessory drive belt.

Fuel system. Examine for leaks and wear.

Cooling system. Examine for leaks.

Air conditioning system.

Drive shafts.

Wheel arch liners and under body protection.

Suspension and steering system. Examine for leaks and wear.

Brake system including park brake. Examine for leaks and wear.

Wheels, tyres and tyre pressure monitoring system. Check tyre pressures and adjust as necessary.

Exhaust system, heat shields and bypass valves. Check for leaks.

Lamp units and the vehicle horn.

Windscreen wiper blades and wash system including fluid levels and adjust accordingly. Examine for leaks and wear.

Occupant restraint systems including airbags, seatbelts and child seat attachment points.

Locks, latches and hinges. Check powered openings such as tailgate for correct operation. Lubricate any joints as necessary.

Instrument cluster and warning symbols.

Item

Fluids and Consumables

Replace the engine oil and engine oil filter. 16,000 km / 10,000 miles

Replace the spark plugs. V8: 64,000 km / 40,000 miles
V12: 128,000 km / 80,000 miles

Replace engine coolant. 120,000 km / 75,000 miles
6 Years

Replace the air filters. 48,000 km / 30,000 miles
3 Years

Replace the pollen filter (optional). 32,000 km / 20,000 miles
2 years

Check and adjust the oil level in the rear differential. 2 years

Replace the oil in the rear differential. 96,000 km / 60,000 miles

(Automatic transmission)

Replace the brake fluid. 2 years

Service Record

The following service records cover the regular services at 16,000 km, 10,000 miles or 12 months intervals, which ever occurs first. Make sure that at each service the appropriate entry is stamped and signed as completed.

Vehicle Model:

Registration Number:

Vehicle Identification Number (VIN):

Delivery Date:

Free Pre-delivery Inspection

Service Actions Checked:	Yes / No
Open Service Actions Completed:	Yes / No
Signature:	
Date:	

Service Information

Odometer:

Technician Name:

Date:

Next Service Due:

Authorised Dealer Stamp

Service Advisor Name:

Service Advisor Signature:

Service Details

Service Actions Checked: Yes / No

Air Filter Changed: Yes / No

Pollen Filter Changed: Yes / No

Spark Plugs Changed: Yes / No

Anti Corrosion Inspection: Yes / No

Fluids Changed:

Additional Service Information

Service Information

Odometer:

Technician Name:

Date:

Next Service Due:

Authorised Dealer Stamp

Service Advisor Name:

Service Advisor Signature:

Service Details

Service Actions Checked: Yes / No

Air Filter Changed: Yes / No

Pollen Filter Changed: Yes / No

Spark Plugs Changed: Yes / No

Anti Corrosion Inspection: Yes / No

Fluids Changed:

Additional Service Information

Service Information

Odometer:

Technician Name:

Date:

Next Service Due:

Authorised Dealer Stamp

Service Advisor Name:

Service Advisor Signature:

Service Details

Service Actions Checked: Yes / No

Air Filter Changed: Yes / No

Pollen Filter Changed: Yes / No

Spark Plugs Changed: Yes / No

Anti Corrosion Inspection: Yes / No

Fluids Changed:

Additional Service Information

Service Information

Odometer:

Technician Name:

Date:

Next Service Due:

Authorised Dealer Stamp

Service Advisor Name:

Service Advisor Signature:

Service Details

Service Actions Checked: Yes / No

Air Filter Changed: Yes / No

Pollen Filter Changed: Yes / No

Spark Plugs Changed: Yes / No

Anti Corrosion Inspection: Yes / No

Fluids Changed:

Additional Service Information

Service Information

Odometer:

Technician Name:

Date:

Next Service Due:

Authorised Dealer Stamp

Service Advisor Name:

Service Advisor Signature:

Service Details

Service Actions Checked: Yes / No

Air Filter Changed: Yes / No

Pollen Filter Changed: Yes / No

Spark Plugs Changed: Yes / No

Anti Corrosion Inspection: Yes / No

Fluids Changed:

Additional Service Information

Service Information

Odometer:

Technician Name:

Date:

Next Service Due:

Authorised Dealer Stamp

Service Advisor Name:

Service Advisor Signature:

Service Details

Service Actions Checked: Yes / No

Air Filter Changed: Yes / No

Pollen Filter Changed: Yes / No

Spark Plugs Changed: Yes / No

Anti Corrosion Inspection: Yes / No

Fluids Changed:

Additional Service Information

Service Information

Odometer:

Technician Name:

Date:

Next Service Due:

Authorised Dealer Stamp

Service Advisor Name:

Service Advisor Signature:

Service Details

Service Actions Checked: Yes / No

Air Filter Changed: Yes / No

Pollen Filter Changed: Yes / No

Spark Plugs Changed: Yes / No

Anti Corrosion Inspection: Yes / No

Fluids Changed:

Additional Service Information

Service Information

Odometer:

Technician Name:

Date:

Next Service Due:

Authorised Dealer Stamp

Service Advisor Name:

Service Advisor Signature:

Service Details

Service Actions Checked: Yes / No

Air Filter Changed: Yes / No

Pollen Filter Changed: Yes / No

Spark Plugs Changed: Yes / No

Anti Corrosion Inspection: Yes / No

Fluids Changed:

Additional Service Information

Service Information

Odometer:

Technician Name:

Date:

Next Service Due:

Authorised Dealer Stamp

Service Advisor Name:

Service Advisor Signature:

Service Details

Service Actions Checked: Yes / No

Air Filter Changed: Yes / No

Pollen Filter Changed: Yes / No

Spark Plugs Changed: Yes / No

Anti Corrosion Inspection: Yes / No

Fluids Changed:

Additional Service Information

Service Information

Odometer:

Technician Name:

Date:

Next Service Due:

Authorised Dealer Stamp

Service Advisor Name:

Service Advisor Signature:

Service Details

Service Actions Checked: Yes / No

Air Filter Changed: Yes / No

Pollen Filter Changed: Yes / No

Spark Plugs Changed: Yes / No

Anti Corrosion Inspection: Yes / No

Fluids Changed:

Additional Service Information

Service Information

Odometer:

Technician Name:

Date:

Next Service Due:

Authorised Dealer Stamp

Service Advisor Name:

Service Advisor Signature:

Service Details

Service Actions Checked: Yes / No

Air Filter Changed: Yes / No

Pollen Filter Changed: Yes / No

Spark Plugs Changed: Yes / No

Anti Corrosion Inspection: Yes / No

Fluids Changed:

Additional Service Information

Service Information

Odometer:

Technician Name:

Date:

Next Service Due:

Authorised Dealer Stamp

Service Advisor Name:

Service Advisor Signature:

Service Details

Service Actions Checked: Yes / No

Air Filter Changed: Yes / No

Pollen Filter Changed: Yes / No

Spark Plugs Changed: Yes / No

Anti Corrosion Inspection: Yes / No

Fluids Changed:

Additional Service Information

Service Information

Odometer:

Technician Name:

Date:

Next Service Due:

Authorised Dealer Stamp

Service Advisor Name:

Service Advisor Signature:

Service Details

Service Actions Checked: Yes / No

Air Filter Changed: Yes / No

Pollen Filter Changed: Yes / No

Spark Plugs Changed: Yes / No

Anti Corrosion Inspection: Yes / No

Fluids Changed:

Additional Service Information

Service Information

Odometer:

Technician Name:

Date:

Next Service Due:

Authorised Dealer Stamp

Service Advisor Name:

Service Advisor Signature:

Service Details

Service Actions Checked: Yes / No

Air Filter Changed: Yes / No

Pollen Filter Changed: Yes / No

Spark Plugs Changed: Yes / No

Anti Corrosion Inspection: Yes / No

Fluids Changed:

Additional Service Information

Service Information

Odometer:

Technician Name:

Date:

Next Service Due:

Authorised Dealer Stamp

Service Advisor Name:

Service Advisor Signature:

Service Details

Service Actions Checked: Yes / No

Air Filter Changed: Yes / No

Pollen Filter Changed: Yes / No

Spark Plugs Changed: Yes / No

Anti Corrosion Inspection: Yes / No

Fluids Changed:

Additional Service Information

Service Information

Odometer:

Technician Name:

Date:

Next Service Due:

Authorised Dealer Stamp

Service Advisor Name:

Service Advisor Signature:

Service Details

Service Actions Checked: Yes / No

Air Filter Changed: Yes / No

Pollen Filter Changed: Yes / No

Spark Plugs Changed: Yes / No

Anti Corrosion Inspection: Yes / No

Fluids Changed:

Additional Service Information

Service Information

Odometer:

Technician Name:

Date:

Next Service Due:

Authorised Dealer Stamp

Service Advisor Name:

Service Advisor Signature:

Service Details

Service Actions Checked: Yes / No

Air Filter Changed: Yes / No

Pollen Filter Changed: Yes / No

Spark Plugs Changed: Yes / No

Anti Corrosion Inspection: Yes / No

Fluids Changed:

Additional Service Information

Service Information

Odometer:

Technician Name:

Date:

Next Service Due:

Authorised Dealer Stamp

Service Advisor Name:

Service Advisor Signature:

Service Details

Service Actions Checked: Yes / No

Air Filter Changed: Yes / No

Pollen Filter Changed: Yes / No

Spark Plugs Changed: Yes / No

Anti Corrosion Inspection: Yes / No

Fluids Changed:

Additional Service Information

Service Information

Odometer:

Technician Name:

Date:

Next Service Due:

Authorised Dealer Stamp

Service Advisor Name:

Service Advisor Signature:

Service Details

Service Actions Checked: Yes / No

Air Filter Changed: Yes / No

Pollen Filter Changed: Yes / No

Spark Plugs Changed: Yes / No

Anti Corrosion Inspection: Yes / No

Fluids Changed:

Additional Service Information

Service Information

Odometer:

Technician Name:

Date:

Next Service Due:

Authorised Dealer Stamp

Service Advisor Name:

Service Advisor Signature:

Service Details

Service Actions Checked: Yes / No

Air Filter Changed: Yes / No

Pollen Filter Changed: Yes / No

Spark Plugs Changed: Yes / No

Anti Corrosion Inspection: Yes / No

Fluids Changed:

Additional Service Information

Service Information

Odometer:

Technician Name:

Date:

Next Service Due:

Authorised Dealer Stamp

Service Advisor Name:

Service Advisor Signature:

Service Details

Service Actions Checked: Yes / No

Air Filter Changed: Yes / No

Pollen Filter Changed: Yes / No

Spark Plugs Changed: Yes / No

Anti Corrosion Inspection: Yes / No

Fluids Changed:

Additional Service Information

Replacement of Airbag Units

Aston Martin recommend that all airbag units are replaced every 10 years from the date of manufacture. To make sure this is completed correctly and safely, this work should be carried out by your Aston Martin Dealership.

Airbag Replacement 10th Year

Odometer:

Date:

Signature:

Replacement of Seat Belt Pre-tensioners

Aston Martin recommend that all seat belt pre-tensioners units are replaced every 10 years from the date of manufacture. To make sure this is completed correctly and safely, this work should be carried out by your Aston Martin Dealership.

Seat Belt Pre-Tensioners Replacement 10th Year

Odometer:

Date:

Signature:

Airbag Replacement 20th Year

Odometer:

Date:

Signature:

Seat Belt Pre-Tensioners Replacement 20th Year

Odometer:

Date:

Signature:



ASTON MARTIN

Aston Martin Warranty

Vehicle Warranties	B.2
Warranty Period.....	B.4
Who May Repair the Vehicle.....	B.4
Wear and Tear Items	B.5
What is Not Covered.....	B.6
Customer Responsibility	B.8
Warranty Coverage when Touring	B.8
Aston Martin Extended Warranty.....	B.9
Consumer Law	B.9
Owner And Vehicle Details	B.10

Vehicle Warranties

Aston Martin gives a Warranty for each new Aston Martin vehicle and each replacement vehicle or assembly manufactured or supplied by the Company to be free from defects in material and workmanship under normal use and service for the applicable Warranty period.

The warranties provided herein are for the benefit of the original purchaser and any subsequent owner during the relevant Warranty Period (defined below) in the Serviced Countries (defined below).

An Aston Martin vehicle is built and homologated to support the Region for which it is manufactured and is compliant with the local regulatory requirements of that Region. As a result, the warranties cover Aston Martin vehicles that are built for and supplied to the Region.

For the purposes of this Owner's Guide, Region means one of the following territories:

- the Americas, including the United States, Canada, and South America; or
- the United Kingdom, Europe, Russia and South Africa; or
- the Middle East, North Africa and India; or
- Asia Pacific, including China, Japan, Taiwan, Hong Kong, Singapore, Australia and New Zealand.

'Serviced Countries' means either: (a) any country in the Region from which your Aston Martin vehicle was purchased, where there is an Aston Martin authorised dealer or repairer; or (b) any country agreed in writing with Aston Martin.

 *Tyres are covered separately by the tyre manufacturer. Dealers are expected to offer assistance to the customer in pursuing a claim against the tyre manufacturer.*

Exchange Parts Under Warranty

New parts will only be used for repairs at PDI and during the first three months or 5000 km/3000 miles (which ever occurs first) from the date the vehicle is handed over to the first retail customer. Thereafter exchange parts must be used where available under Aston Martin's exchange plan.

Anti Perforation Corrosion Protection Warranty

The vehicles bodywork is protected by an Anti Perforation Corrosion Warranty. Should any part of the bodywork of the Aston Martin vehicle be perforated, the panel(s) affected by the perforation will be repaired or replaced.

The term 'perforation' means a hole that penetrates through a body panel from the inside.

Warranty Period

The period of cover for all types of warranty commences on the day the vehicle is handed over to the first registered keeper of the car (first registered keeper shall mean the Dealer in the context of demonstration vehicles).

The Vehicle Warranty period of cover is three years with unlimited mileage.

The Anti-Perforation Corrosion Warranty period of cover is ten years with unlimited mileage.

Who May Repair the Vehicle

Franchise Holders or Approved Repairers, who are appointed and receive full technical support from Aston Martin, provide facilities for the servicing and repair of Aston Martin motorcars. Only such Franchise Holders or Approved Repairs will under the terms of this warranty, repair replace or readjust, free of charge to the owner, any part or assemble proved to Aston Martin's satisfaction to show a defect in materials or workmanship within the applicable period.

Wear and Tear Items

Items that are subject to wear and tear are generally divided into two categories, namely those specified for replacement or adjustment during scheduled maintenance and those that require replacement or adjustment dependent upon conditions of use.

Scheduled Maintenance Items

The items listed below are covered by the Vehicle Warranty up to the first scheduled change point that replacement or adjustment is required during scheduled maintenance operations. The customer literature supplied with the new Vehicle includes a service book setting out such scheduled maintenance operations.

- Drive belts
- Spark plugs
- Oil, air, pollen and fuel filters.

 *The period of warranty cover for any item may not exceed the time and distance limitation of the vehicle warranty.*

Wear and Tear Items

The items listed below are recognised as having a limited service life or are subject to wear or damage. However, these items are covered by the vehicle warranty for up to one year or the first service, whichever occurs first.

- Wiper blades.
- Wheel alignment and balancing.
- Adjustments, including but not limited to: headlamp and hinged panel adjustments, suspension tightening, steering geometry adjustments, emission and fuel systems checks.
- Vehicle key batteries.

 *Brake pads, brake discs and other friction related components are not covered when replacement is due to wear and tear, but they are covered against manufacturing defects (whether in material or workmanship) for the duration of the Vehicle Warranty.*

What is Not Covered

Consumables

Replacement or top up of consumable fluids, e.g. oils, antifreeze, brake fluid, windscreen wash solution and refrigerant, will only be covered when they are used as part of a warranty repair.

Vehicle Warranty

Aston Martin is **not** responsible for any repair or replacement that is required as a direct result of:

- Normal wear and tear.
- Friction related components, e.g. brake pads and brake discs.
- Failure to properly maintain the vehicle in accordance with Aston Martin's maintenance schedules and service instructions.
- Failure to use Aston Martin specified parts or fluids during a warranty repair (or parts of equivalent quality during a retail repair).
- Damage resulting from neglect, accident, flooding or improper use.
- Any modification of the vehicle or parts which is not authorised by Aston Martin, including any engine performance enhancement modifications.
- Refilling or topping up with incorrect fuel, e.g. diesel instead of petrol.
- Use of bio ethanol alternative fuels.
- Use of a fuel not approved or recommended by Aston Martin in the Owner's Guide is considered misfuelling, and that any damage resulting from mis-fuelling is not covered by the vehicle warranty.
- Defects caused as a result of the vehicle being used in motor sport or track events or for any other purpose other than normal private or commercial use.
- Any vehicle that has had its vehicle identification number altered or removed, or on which the odometer reading has been unlawfully altered.

Paint Surface and Corrosion Protection

Aston Martin is not responsible for any repair or replacement that is required as a direct result of the following:

- Failure to properly maintain paint and bodywork by regular cleaning in accordance with Aston Martin instructions.
- Factors beyond Aston Martin's control, such as environmental hazards (including industrial fallout, storm damage, acid rain) and damage (including stone chips, scratches and use of unsuitable cleaning agents).
- Accident repairs using materials or methods of repair that have not been approved by Aston Martin.
- Alterations of the vehicle from Aston Martin's original specification.
- Failure to rectify on a timely basis any paint or corrosion damage as recorded in the vehicle documentation by a dealer at the time of the annual inspection.

Other Exclusions

The Aston Martin warranty excludes liability for any lost time, inconvenience, loss of transportation, or any other incidental or consequential damage you (or anyone else) may incur as a result of a defect covered by this warranty.

Customer Responsibility

This handbook describes the proper care and use of the vehicle. Proper maintenance and use guard against major repair expenses resulting from misuse, neglect or inadequate maintenance, and may help increase the value that the customer may receive when selling the vehicle.

The Customer is responsible to:

- Make sure that the vehicle is maintained in accordance with the vehicle service and maintenance guide published in the customer literature.
Failure to perform maintenance promptly and in accordance with Aston Martin's specified service intervals will invalidate warranty coverage on the parts affected.
- The customer is required to take the vehicle to a dealer for any warranty repairs as soon as practicable after a defect is detected.
- Make sure that the Service and Maintenance schedule has been stamped by the servicing dealer after the completion of a scheduled service operation.
- Make sure that paint and bodywork is maintained by regular cleaning in accordance with the vehicle manufacturer's instructions.
- Make sure that the body panels are examined annually by an authorised Aston Martin Dealer and that this inspection is recorded in the Owner's Handbook.

Warranty Coverage when Touring

Aston Martin has a comprehensive service network in most parts of the world. Any authorised Aston Martin Dealer can carry out repairs under the terms of the vehicle warranty. Under normal circumstances, the customer should not be required to pay for any warranty work performed by an Aston Martin Dealer.

It is the customer's responsibility to produce the warranty documentation issued with the new vehicle. This establishes the customer's right to warranty coverage and the relevant maintenance and service records. If the customer is unable to do so, the dealer should seek advice from Aston Martin.

Aston Martin Extended Warranty

Aston Martin Extended Warranty is specifically designed to provide the customer with first class after-sales protection from unexpected repair costs when the vehicle warranty has expired, and the knowledge that your Aston Martin will be repaired by trained technicians using only genuine Aston Martin parts.

Contact your Aston Martin Dealer for more information on the benefits and protection provided by the Aston Martin Extended Warranty.

Consumer Law

The Warranty is a manufacturer's warranty that supplements and does not affect the Owner's legal rights under the vehicle purchase agreement or under applicable national legislation governing the sale of consumer goods.

Owner And Vehicle Details

Name:

Registration Plate No.:

Address:

VIN No.:

:

Engine No.:

:

Warranty Start Date:

:

Post Code:

If the vehicle is sold, the benefits of any un-expired portion of the warranties can be transferred to the new owner.

The new owner should complete a 'tear off' sheet (next page) and send the new details to:

Aston Martin Warranty Department
Aston Martin Lagonda Limited
Banbury Road
Gaydon
Warwick
CV35 0DB
England

Signature:

Date:

Dealer Stamp

Owner Warranty Transfer (2)	Owner Warranty Transfer (1)
VIN No.:	VIN No.:
Odometer:	Odometer:
Date of Purchase:	Date of Purchase:
Name:	Name:
Address:	Address:
:	:
:	:
Post Code:	Post Code:
Telephone No.:	Telephone No.:
Email Address:	Email Address:
Signature:	Signature:
Date:	Date:



ASTON MARTIN



ASTON MARTIN

Owner Warranty Transfer (4)	Owner Warranty Transfer (3)
VIN No.:	VIN No.:
Odometer:	Odometer:
Date of Purchase:	Date of Purchase:
Name:	Name:
Address:	Address:
:	:
:	:
Post Code:	Post Code:
Telephone No.:	Telephone No.:
Email Address:	Email Address:
Signature:	Signature:
Date:	Date:



ASTON MARTIN



ASTON MARTIN

Owner Warranty Transfer (6)	Owner Warranty Transfer (5)
VIN No.:	VIN No.:
Odometer:	Odometer:
Date of Purchase:	Date of Purchase:
Name:	Name:
Address:	Address:
:	:
:	:
Post Code:	Post Code:
Telephone No.:	Telephone No.:
Email Address:	Email Address:
Signature:	Signature:
Date:	Date:



ASTON MARTIN



ASTON MARTIN

Aston Martin Assistance

Emergency Assistance	C.2
Benefits	C.3
Alternative Travel Arrangements	C.5
What To Do In An Emergency	C.9
European Autoroute Restrictions.....	C.10
What is not Covered	C.10
Schedule - Eligible Vehicles	C.14

Emergency Assistance

As the owner of an Aston Martin vehicle you should enjoy a high standard of trouble free motoring. However, should the unexpected occur, our worldwide Dealer network is there to help you. Details and contact telephone numbers are shown in the Dealer Directory. In the UK and specific countries within Europe, a special additional emergency service, known as '**Aston Martin Emergency Assistance**', has been designed to provide you and your passengers with the help you need quickly and efficiently should your vehicle suffer a Breakdown Incident ¹.

Vehicles Covered

The benefits of Aston Martin Emergency Assistance are applicable to new and approved pre-owned Aston Martin vehicles purchased from an authorised Aston Martin Dealer. Refer to www.astonmartin.com for a list of all authorised Aston Martin Dealers.

At completion of your purchase, your Aston Martin Dealer will register your vehicle for Aston Martin Emergency Assistance. From registration, your vehicle will be entitled to Aston Martin Emergency Assistance (the '**Vehicle**'). For more details of what constitutes an eligible Vehicle, and term of cover, please refer to the Schedule.

Owners of eligible Vehicles can also obtain Aston Martin Emergency Assistance when travelling temporarily outside their Country ², within Europe.

¹. A **Breakdown Incident** means an event where an eligible Vehicle is immobilised due to a breakdown in circumstances where it qualifies for Aston Martin Emergency Assistance, including home-starts or broken glass. Furthermore, Aston Martin Emergency Assistance covers you in the event of safety-related defects, which render the Vehicle illegal to drive. These defects relate to, for example, failure of the seat belts, windscreen wipers, direction indicators, front and rear lamps.

². '**Country**' means the country in which your Vehicle is registered.

Benefits

Europe is defined as:

Andorra, Austria, Belgium, Bosnia- Herzegovina, Bulgaria, Crete, Croatia, Czech Republic, Denmark, Estonia, Finland, France, Germany, Gibraltar, Greece, Hungary, Italy, Latvia, Liechtenstein, Lithuania, Luxembourg, Malta, Monaco, Morocco, Netherlands, Norway, Poland, Portugal (not Madeira), Republic of Ireland, Romania, Russia, San Marino, Slovakia, Slovenia, Spain (including the Balearic and Canary Islands), Sweden, Switzerland, Turkey (European part), Ukraine, and Vatican City (Rome);.

United Kingdom (UK) is defined as:

England, Scotland, Wales, Northern Ireland, Channel Islands and Isle of Man.

The service provider, appointed by Aston Martin to provide the Aston Martin Emergency Assistance services (the 'Service Provider') will provide the following benefits dependent on requirements to entitled Vehicles in both the home Country and Europe as defined.

Roadside Assistance

The Service Provider's Agent vehicle should promptly arrive with you after your call has been placed. You may also book an appointment for a convenient time.

Aston Martin Emergency Assistance shall provide you with updates on its estimated time of arrival via your preferred communication method.

If following a Breakdown Incident in an area of coverage, your journey cannot be completed, and where the Vehicle cannot be repaired at the roadside, Aston Martin Emergency Assistance shall organise recovery of the Vehicle, including any luggage contained in the Vehicle at the time. Your Vehicle and luggage shall be transported to the nearest Aston Martin Dealer, without distance or financial limitation.

If the Vehicle cannot be repaired at the roadside or at your home address within a reasonable time period (45 minutes), the Service Provider will take you, the Vehicle and your passengers to the nearest Aston Martin Dealer. In the event that you (or your passengers) need to keep an important appointment, you will be taken there before the disabled Vehicle is transported to its required destination.

Should the Breakdown Incident occur outside of workshop hours, Aston Martin Emergency Assistance shall arrange for secure storage of the Vehicle until the next working day. The Vehicle shall arrive at the Dealer by midday on the next day. If the nearest Dealer, to where the eligible Vehicle has been towed, is able to carry out the repairs at its premises, then the Vehicle will be repaired there.

Once the Vehicle is at a Dealership for repair, Aston Martin Emergency Assistance will keep in contact with the Dealer to follow the progress of the repair, and if necessary, arrange any extension of a replacement vehicle with Aston Martin Customer Service.

Home Start

Aston Martin Emergency Assistance will provide all the benefits of Roadside Assistance at the Vehicle's registered address.

Recovery

If Aston Martin Emergency Assistance cannot repair your Vehicle at the roadside, the Service Provider will arrange recovery of you and your Vehicle to the nearest Aston Martin Dealer.

If your Vehicle has been involved in an accident or has gone off the road and needs to be salvaged before towing, Aston Martin Emergency Assistance will charge you for services on a 'Pay for Use' basis and you may be able to claim these back from your insurance company.

You will be covered for costs of recovery and towing (including any handling fee) but you may be charged for any costs incurred if the Vehicle is, for example, disabled by floods or snow-affected roads, is embedded in sand or mud, or is not easily accessible.

If your Vehicle cannot be repaired and / or recovery is initiated to an Aston Martin Dealer, the Service Provider will provide alternative travel options for you. You will be entitled to receive one of the following additional services:

- An alternative replacement vehicle for up to two working days in your Country, or 14 days if the Breakdown Incident occurs outside your Country (a collection and delivery service, or equivalent, is available from chosen suppliers subject to availability and supplier's terms and conditions);
- Onward transportation;
- Overnight accommodation.

Vehicle Collection Following Repair

Following repairs organised by Aston Martin Emergency Assistance, the cost of a first class rail ticket or (if rail transport would normally exceed six hours) a business class air ticket will be met to permit you or a person you designate to collect the repaired Vehicle. Alternatively, arrangements can be made for your Vehicle to be returned to your home or business address, whichever is the nearest to the repairing Dealer. Alternative addresses closer to the repairing Dealer may also be considered.

Alternative Travel Arrangements

If the Service Provider estimates that the repairs to your Vehicle will take more than eight hours, the Aston Martin Emergency Assistance will cover your reasonable costs for alternative necessary travel, including for members of your party.

Reasonable additional expenses shall be covered for one or a combination of the following:

- Alternative replacement vehicle costs to a maximum of two working days in your Country and up to 14 days outside your Country.
- Air fares (business class ticket).
- Rail fares (first class ticket).
- Local taxi fares.
- Any other transport equivalent to first class rail fares.

Replacement Vehicle

If following a Breakdown Incident:

- Your Vehicle is immobilised.
- Roadside repairs are unsuccessful.
- If repair of the Vehicle is not possible within the same day after towing to the Dealer.

Aston Martin Emergency Assistance will organise free of charge, an alternative replacement vehicle for you until completion of the repairs. The replacement vehicle will include fully comprehensive insurance ¹, with an option to upgrade to include collision damage waiver.

The loan of this alternative replacement vehicle will not exceed two working days (in your Country) or, if the Breakdown Incident occurred outside your Country, 14 days plus two working days after your return to your home country.

Aston Martin Emergency Assistance aim to make sure that the alternative replacement vehicle is a suitable vehicle for you. Specially adapted replacement vehicles will not be provided.

The alternative replacement vehicle will be delivered to you, where possible, but if you prefer, taxi costs for collecting the alternative replacement vehicle, will be met by Aston Martin Emergency Assistance.

You will be responsible for fuelling and basic maintenance of the alternative replacement vehicle, while under your care. You will also be responsible for paying any deposit required by the vehicle Hire Company.

Once the repair on your Vehicle is complete, the alternative replacement vehicle will then either be returned to the vehicle Hire Company or collection will be arranged where possible, at your request.

¹. Unless the driver is under 21 years of age, where there may be an additional charge incurred.

If the alternative replacement vehicle has been kept beyond the term of the permitted loan period (as noted above), you will be responsible for any additional charges incurred for the extended period. If you cannot fulfil the nominated vehicle Hire terms and conditions, or circumstances prevent you from qualifying to hire the vehicle, and alternative mobility arrangements are more appropriate, then onward travel arrangements or hotel accommodation will be provided instead. The vehicle hire agreement will be between you and the relevant supplier and will be subject to that supplier's Terms and Conditions. These will usually require or include (amongst other things):

- Production of a full driving licence valid at the time of issue of the hire vehicle.
- Limits on acceptable endorsements.
- Limitations on the availability and, or engine capacity of the replacement vehicle.
- A deposit, e.g. for fuel.
- Drivers to be aged at least 21 years depending on Country, and to have held a full driving licence for at least 12 months.

Onward or Home Journey

If following a Breakdown Incident that occurs more than 80 km (50 miles) from your place of residence, your Vehicle cannot be repaired at the roadside on the same day of the Breakdown Incident, Aston Martin Emergency Assistance will cover:

- The costs of the journey from the place of the Breakdown Incident to the nearest Dealer.
- The costs of a replacement vehicle as outlined above.
- Where necessary, taxi costs for one journey to the nearest accessible train station or airport, for you and your passenger(s).
- Where necessary, the costs of a first class train journey for you and your passenger(s). If the train journey exceeds six hours, the cost of a scheduled flight (Business Class) for you and your passenger(s).

Aston Martin Emergency Assistance will reimburse you for reasonable costs incurred relating to the above, upon receipt of a claim letter from you, detailing the circumstances of the claim, along with receipts for all transport costs claimed. All claim letters must be directed to Aston Martin Emergency Assistance at Aston Martin Customer Service, Aston Martin Lagonda Limited, Banbury Road, Gaydon, Warwick, CV35 0DB. Only costs directly connected with the Breakdown Incident will be covered.

The refund process to you shall be managed by Aston Martin Emergency Assistance.

Repaired Vehicle Re-delivery

Aston Martin Emergency Assistance will attempt to contact you within 24 hours of successful repair at the Dealer in order to arrange re-delivery of the repaired Vehicle to either your home or place of work, as you request. Alternative addresses closer to the Repairing Dealer may also be considered.

Hotel

If following a Breakdown Incident that occurs more than 80 km/ 50 miles from your place of residence, and your Vehicle cannot be repaired at the roadside on the day of the Breakdown Incident, accommodation costs for you and your passenger(s) shall be covered for the duration of the repair, for up to a maximum of two nights if the Breakdown Incident occurs in your Country, or seven nights if the Breakdown Incident occurs outside your Country. You shall be responsible for any excess costs.

Repatriation of Un-repaired Vehicle from Abroad

If the Vehicle cannot be repaired by Aston Martin Emergency Assistance within an agreed time schedule (three working days), the costs for transporting the Vehicle and its contents from the Dealer to the home Country Dealer, will be covered by Aston Martin Emergency Assistance.

Aston Martin Emergency Assistance shall arrange the safe repatriation of the Vehicle at the least cost, while respecting the need to deliver the Vehicle to the home Dealer within 14 consecutive days.

Aston Martin Emergency Assistance will cover the costs for parking the Vehicle, pending repatriation or import.

What To Do In An Emergency

Should assistance be required in the unlikely event of a Breakdown Incident, simply contact Aston Martin Emergency Assistance using the relevant telephone number listed below.

 *It may be helpful to have the relevant telephone numbers entered into your mobile phone 'phone book'.*

00 800 28 86 28 86 ¹

+44 208 603 9875

When connected, enter the 2 digit number as prompted for your home country. Please do not make your own arrangements as Aston Martin Emergency Assistance will be not be able to reimburse you. If you are in a remote location and need assistance, the time taken to receive the assistance may be longer because of distance and local restrictions.

Vehicle Identification and Location

To minimise delay, please have the following information available:

- Your name.
- Aston Martin model.
- The Vehicle Identification Number (VIN). The last six digits from the VIN label in the corner of the windscreen.
- The location of the vehicle.
- Vehicle registration number and colour.
- Telephone number where you can be contacted.
- Description of the concern experienced.

¹. Calls from landlines shall be free. Calls from mobile phones will be charged at standard mobile network rates.

European Autoroute Restrictions

If assistance is required on a French Autoroute or on certain Autoroutes in other European countries, you must use the official SOS boxes at the side of the road in order to arrange initial assistance or recovery. You will be connected to the authorised Autoroute Assistance Service because these roads are privatised. Neither Aston Martin Emergency Assistance nor any other assistance organisations are allowed to assist on these roads.

Once your Aston Martin has been recovered from the Autoroute, you should contact Aston Martin Emergency Assistance at the earliest opportunity to make sure that any further assistance arrangements you require can be made on your behalf.

Aston Martin Emergency Assistance will advise you how to reclaim costs incurred for recovery from the Autoroute.

What is not Covered

Aston Martin Emergency Assistance is thorough and comprehensive; however, claims cannot be met as a result of any of the following:

1. Where you, or anyone else acting on your behalf, make repair or service arrangements without authorisation (and a file number) from Aston Martin Emergency Assistance.
2. Where any loss, theft, damage, death, bodily injury, cost or expense that is not directly associated with the incident that caused you to claim, unless expressly stated in this policy.
3. If the Breakdown Incident is due to fire, theft, accident or vandalism, your costs will not be covered by Aston Martin Emergency Assistance but should be met by third party insurance covering the incident.
4. Damage or injury intentionally caused by you or resulting from your participation in a criminal offence.
5. If your Vehicle is kept in an un-roadworthy condition or has not been serviced in accordance with the Manufacturer's recommendations.
6. Any costs that would have been payable by you, such as petrol, toll charges, parking fees, cost of meals, drinks, telephone calls and/ or newspapers or any other costs not specifically stated as being covered by Aston Martin Emergency Assistance, which may be incurred by you and/ or the other member(s) of your party as a result of and/ or in connection with the Breakdown Incident.

-
7. Release fees: Should your Vehicle be stolen and subsequently recovered by the police, you may be asked to pay a release fee before we can remove your Vehicle to an authorised Aston Martin Dealer.
 8. Specialist charges: In the event that the use of specialist equipment is required to give assistance when your Vehicle has, for example, gone off the road, is in a ditch, is standing on soft ground, sand, shingle, stuck in water or snow or has been immobilised by the removal of its wheels, we will arrange recovery but you will be responsible for the costs of any specialist equipment required. The costs may be refundable under the terms of your motor insurance policy.
 9. Adverse weather conditions: On those occasions when we experience adverse weather conditions, such as high winds, snow, floods, etc., external resources may be stretched and some operations become physically impossible until the weather improves. At such times, our priority is to make sure that you and your passengers are taken to a place of safety and so the recovery of your Vehicle may not be possible until weather conditions permit.
 10. Customer induced breakdown incidents are not covered under Aston Martin Emergency Assistance. However, Aston Martin and the Service Provider will, at their sole discretion, assist you if you request it. However we are not obligated to provide assistance and you shall be responsible for any charges resulting from any assistance given caused by a customer induced fault. In such circumstances, a swipe card deposit may be taken by the Service Provider. Assistance in such circumstances will not include additional benefits (replacement vehicle, onward journey, hotel accommodation).
Customer induced faults may include, for example, the following:
 - Lock-outs / lost keys
 - Broken keys
 - Discharged battery
 - Running out or loss of fuel
 - Use of wrong fuel (no replacement at the location of breakdown, only towing)
 - Tyre damage
 - Road traffic accidents.

-
11. Lockout / lost keys: Whilst we will always try to provide assistance by the most practical method, should you be unable to gain entry to your Vehicle, modern security systems make it extremely difficult for this to be done should spare keys not be available. If a forced entry is required, you will be asked to sign a declaration stating that you have given permission for this to take place and that any costs for resultant damage will be your sole responsibility.
 12. Aston Martin Emergency Assistance shall not be required to provide services in the following circumstances:
 - 12.1 In respect of eligible Vehicles situated on private property (for example garage premises) unless you can establish to the reasonable satisfaction of Aston Martin Emergency Assistance that permission has been given by the relevant owner or occupier.
 - 12.2 Vehicle servicing or re-assembly where this is required as a result of neglect or unsuccessful work on the Vehicle other than on the part of the Service Provider or its agents.
 - 12.3 The recovery of any Vehicles bearing trade plates or which Aston Martin Emergency Assistance has reason to believe have just been imported or purchased at auction.
 - 12.4 The transportation of immobilised Vehicles where Aston Martin Emergency Assistance considers this to be part of a commercial activity.
 - 12.5 Assistance for Vehicles broken down as a result of taking part in any 'Motor Sport Event', including, without limitation, motor racing, rallying, speed or duration tests or practice thereof, trials or time-trials, auto test (other than auto tests performed by the Client using roadworthy, road legal cars on public roads), but excluding 'Concours d'elegance' events, track test days for road-legal Vehicles or rallies held exclusively on open public roads where participants are required to comply with the normal rules of the road (save for Aston Martin organised and controlled track day events).
 - 12.6 Where the police, highways agency and / or other emergency service require that your Vehicle be recovered by a third party.
 - 12.7 Where your entitlement to Aston Martin Emergency Assistance lapses or if your Vehicle is no longer considered eligible for Aston Martin Roadside Assistance, the Service Provider may charge you directly for the Services provided. Any such charges will be charged on a 'pay for use' basis and will constitute a direct contract between you and the Service Provider. If it is determined that Aston Martin is at fault for the Vehicle not being recorded as an eligible Vehicle, then Aston Martin shall pay the relevant charges.
 - 12.8 Assistance for routine maintenance and running repairs of the Vehicle such as fixing faulty radios and heated rear windows.

-
- 12.9 For transit risk insurance, which Aston Martin Emergency Assistance recommends you take out where a Vehicle is to be repatriated.
- 12.10 Where locksmiths, body-glass or tyre specialists are required. Aston Martin Emergency Assistance will endeavour to arrange for their assistance on your behalf, however, you will be responsible for the costs of their services. Further, if use of a locksmith or other specialist would, in Aston Martin Emergency Assistance's opinion, mobilise the vehicle, no further service will be given for the breakdown in question.
- 12.11 The transportation of any animal or pets shall be at the sole discretion of the Service Provider.

13. The Service Provider may charge you directly for:
- Any replacement component, lubricant and / or fuel (the 'Parts') or consumable items supplied (except where Aston Martin has provided or paid for such Parts)
 - Any extension of the Services which you are entitled to receive in connection with this Agreement (which shall be performed by the Service Provider (in its absolute discretion) at your request.
 - The use of any specialist lifting or towing assistance needed to recover your Vehicle if your Vehicle has gone off the road, is in a ditch, sunk in soft ground, sand or shingle or when it is stuck in snow or flood water.
 - Any additional charges resulting from the failure to carry legal and serviceable spare wheel(s) or tyre(s) in the Vehicle. Aston Martin Emergency Assistance will endeavour to arrange assistance from a third party on your behalf but you will be responsible for the costs of the call out and/ or for any repair.
 - The cost of garage or other labour required to repair the Vehicle, other than that provided by Aston Martin Emergency Assistance at the scene of the Breakdown Incident.
 - Any costs of draining or removing fuel, lubricants or other fluids as a result of the introduction of an inappropriate substance.

Schedule - Eligible Vehicles

- Transportation of personal effects, goods, vehicles, boats or other waterborne craft on or in the Vehicle and any trailer or caravan. Aston Martin Emergency Assistance will not consider any claim for loss resulting from damage to / loss of use of these items. Such items remain your responsibility at all times.
14. If following a Breakdown Incident, the Service Provider, its third party garage agent or subcontractor makes a temporary repair to your Vehicle (for these purposes, a temporary repair shall mean temporary repairs of the Vehicle where the underlying cause of the Vehicle's failure is not resolved), then the Service Provider, its third party garage agent or subcontractor shall recommend you to have such temporary repair made good by a Dealer.

New Vehicles - 36 Months Cover

Any Aston Martin vehicle which is sold directly by Aston Martin or a Dealer in the UK or European Territories and which is first registered in the UK or European Territories (Refer to 'Emergency Assistance', page C.2).

Used Vehicles

(Cover may vary - consult with the selling Dealer)

Those used vehicles registered in the UK or the European Territories in respect of which an Extended Warranty has been started.

In All Cases

- Maximum Gross Vehicle Weight (including any caravans or trailers being towed at the time of the Breakdown Incident): 3500 Kg
- Maximum Vehicle Length: 5.5 m
- Maximum Vehicle Width (including any caravans or trailers being towed at the time of the Breakdown Incident): 2.3 m
- Maximum Vehicle Height: 3 m

The dimensions detailed above will be calculated taking into account anything attached to the relevant eligible Vehicle at the time of the relevant Breakdown Incident and any trailer or caravan, including but not limited to towing equipment, any carriers or racks (e.g. bike or luggage), or anything else attached to the Vehicle or the carriers / racks.

Vehicles must be built to manufacturer's specifications and, where applicable, hold a certificate of roadworthiness.

Alphabetical Index

A		
Accessory Sockets	3.43	
Adaptive Damping	5.17	
Anti-Theft Systems	2.14	
Alarm	2.14	
Engine Immobiliser	2.14	
Motion Sensor	2.15	
Tow Away Protection	2.15	
Aston Martin Assistance	C.1	
Aston Martin Facilities	A.2	
Aston Martin Tracking	2.15	
Aston Martin Warranty	B.1	
Audio		
Specification	8.2	
B		
Battery	12.30	
Blind Spot Assist	5.14	
Bonnet Release	12.7	
Brakes	5.18	
ABS	5.20	
Brake Warnings	5.19	
Footbrake	5.18	
Park Brake	5.21	
C		
Centre Stack Controls	4.5	
Child Safety	3.18	
ISOFIX	3.28	
	PAD	3.20
	Tether Anchors	3.34
	Climate	
	Climate Menu	6.5
	Climate Control	
	Automatic Climate Control	6.4
	Manual Climate Control	6.4
	Climate Controls	6.2
	Infotainment	6.3
	Switches	6.2
	Cruise Control	5.8
	Cylinder Deactivation	5.28
	D	
	Data Recording	E.4
	Defrosting and Demisting	
	Automatic	6.7
	Drive Modes	5.11
	Driving Techniques	5.2
	E	
	Easy Entry/Exit	2.8
	Emergency Engine Start	2.12
	Emergency Key	2.11
	Engine Start	5.4
	ERA-GLONASS	5.39
	ESP (Electronic Stability Program)	5.23
	F	
	Fluid Capacities	12.12

Fluid Specifications	12.11
Fluids and Capacities	12.8
Fuel	12.53
Fuses	12.19

G

Gasoline Particulate Filter (GPF)	5.30
---	------

H

Homelink Wireless Control	2.19
---------------------------------	------

I

Instrument Cluster

Media	4.13
Menu	4.11
Navigation	4.13
Radio	4.13
Service	4.13
Settings	4.13
Telephone	4.13
Trip	4.12

Instrument Display	4.2
--------------------------	-----

J

Jump Start	12.47
------------------	-------

K

Key Battery Replacement	2.4
-------------------------------	-----

L

Lamps	12.33
Lighting	4.15
Exterior	4.15

D.2 Alphabetical Index

Interior	4.17
Locking and Opening	
Outside	2.6

M

Media

Media select	8.10
Radio Functions	8.5
Sound	8.17

Memory Functions	3.9
------------------------	-----

Mirrors	3.6
---------------	-----

Exterior	3.7
Interior	3.6

Multimedia

Bluetooth	8.16
Media Menu	8.12
Media Register	8.16
Radio Menu	8.6

Multimedia Controls	8.4
---------------------------	-----

N

Navigation

Controls	9.3
Destination	9.10
Options	9.4
Position Menu	9.9
Route	9.8
Traffic	9.7
Navigation Menu	9.14

O

Occupant Restraint System	3.10
---------------------------------	------

ORC	
Airbags	3.16
Seat Belts	3.12
Owner Maintenance Checks	12.5
P	
Park Assist Systems	5.31
360° Camera System	5.36
Active Park Assist	5.33
Performance	12.42
Q	
Quick Start	
Driving Position	1.3
Infotainment	1.11
Vehicle Controls	1.6
Vehicle Key	1.2
R	
Replacement of Airbag Units Record	A.29
Replacement of Seat Belt Pre-tensioners Record	A.29
S	
Safety Defects - Reporting	E.4
Seat Adjustment	3.2
Seat release	3.3
Service Record	A.7
Servicing	A.5
Servicing Precautions	12.3
Settings	
System	10.3
Time	10.2
Vehicle	10.2

Specifications	
4.0L V8 Engine	12.40
5.2L V12 Engine	12.39
Body	12.14
Brakes	12.14
Steering	12.14
Suspension	12.14
Transmission	12.41
Steering Column	3.8
Steering Controls	4.10
Stop/Start	5.29
Storage	3.39
T	
Tool Kit	12.5
Touch Pad	4.7
Track Days	5.2
Transmission Controls	5.5
Automatic	5.5
Touchtronic	5.7
Tyre Pressure Monitoring System (TPMS)	5.26
Tyres	12.16
Summer Tyres	12.18
Tyre Pressures	12.16
Tyre Repair Kit	12.51
Winter Tyres	12.18
U	
Unlocking and Opening	2.5
Deck Lid	2.8
Interior	2.7
Outside	2.5

V

Vehicle Identification	E.3
Vehicle Key	2.2
Vehicle Provenance	A.3
Vehicle Recovery	12.46
Voice Control	4.14

W

Washers and Wipers	12.13
Windows	3.5
Wiper Controls	4.15



ASTON MARTIN